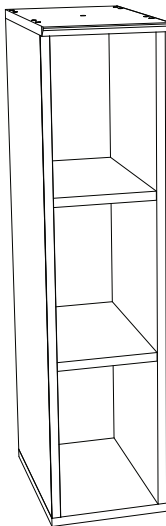
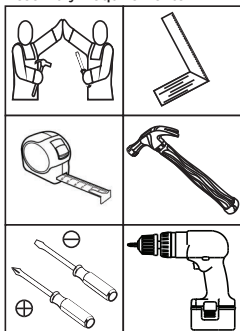

HENNInd. e Com. de Móveis Henn
Mondai - SC - Brasil

☎ +55 49 3674.3500

📧 @moveishenn
www.henn.com.br**INSTRUÇÕES DE
MONTAGEM**INSTRUCCIONES DE MONTAJE
ASSEMBLY INSTRUCTIONS**Aéreo Nicho 200mm Requite |
Aéreo Niche 200mm Requite |
Aerial Niche 200mm Requite**

C637-128 Nature

Requisitos para montagem
Requisitos para la montaje
Assembly RequirementsImagens meramente ilustrativas,
não acompanha o produto.
Imágenes ilustrativas, no incluidas
con el producto.
Illustrative images, not included
with the product.**AVISO**

Para limpeza de seu móvel, use uma franela seca ou umedecida, e não utilize produtos químicos que possam danificar seu produto.

SISTEMA DE MONTAGEM

O sistema de montagem dos produtos, funciona de acordo com a ordem crescente dos números indicados no desenho. Ex: 01, 02, 03, 04... até a conclusão da montagem.

ASSISTÊNCIA TÉCNICA

Para solicitação de Assistência Técnica você consumidor deverá entrar em contato com o Lojista o qual você realizou a compra deste produto e solicitar a assistência técnica das peças avariadas. A garantia abrange todas as peças, partes e componentes que eventualmente venham apresentar defeito de fabricação no prazo de 03 (três) meses, contando a partir da entrega do produto ao consumidor, mediante nota fiscal de compra. Se houver qualquer alteração na estrutura do produto ou ocorrer defeito por negligência do montador/consumidor em relação a instrução de montagem e manuseio, não será fornecido assistência técnica gratuita.

ADVERTENCIA

Para limpieza de su móvil, use una franela seca o húmeda, y no utilice productos químicos que puedan dañar su producto.

SISTEMA DE MONTAJE

El sistema de montaje de los productos funciona de acuerdo con el orden creciente de los números indicados en el dibujo. Ej.: 01, 02, 03, 04... hasta la conclusión del montaje.

ASISTENCIA TÉCNICA

Para solicitar Asistencia Técnica, el consumidor debe comunicarse con el Comercio que usted realizó la compra de este producto y solicita asistencia técnica para las partes dañadas. La garantía cubre todas las partes, piezas y componentes que eventualmente puedan presentar defecto de fabricación en el plazo de 03 (tres) meses, contados a partir de la entrega del producto al consumidor, mediante factura de compra. Si se produce algún cambio en la estructura del producto o se produce un defecto por negligencia del montador/consumidor en relación con las instrucciones de montaje y manipulación, no se prestará asistencia técnica gratuita.

NOTICE

To clean your furniture, use a dry or wet cloth, and do not use chemicals that may damage your product.

ASSEMBLY SYSTEM

The products' assembly system works according to the increasing order of the indicated numbers. For example: 01, 02, 03, 04 ... to the end of the assembly.

TECHNICAL ASSISTANCE

To request Technical Assistance, the consumer must contact the retailer from whom you purchased this product and request technical assistance for the damaged parts. The warranty covers all parts, parts and components that may eventually present a manufacturing defect within a period of 03 (three) months, counting from the delivery of the product to the consumer, by means of a purchase invoice. If there is any change in the structure of the product or defect occurs due to negligence of the assembler/consumer in relation to the assembly and handling instruction, free technical assistance will not be provided.

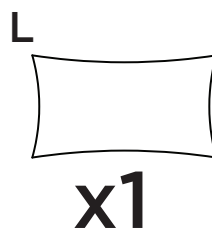
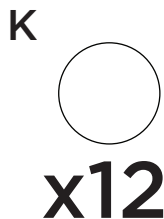
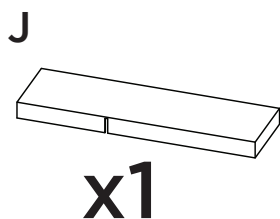
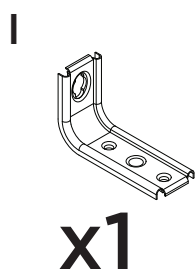
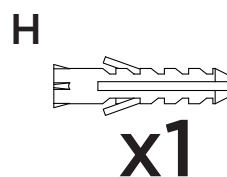
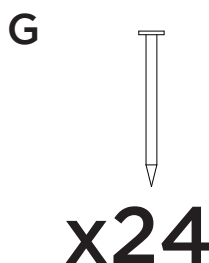
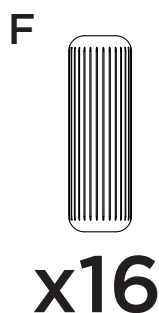
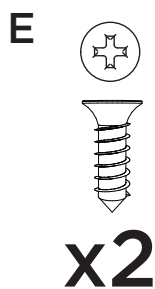
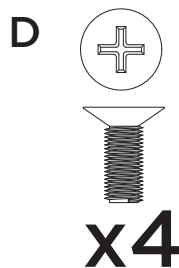
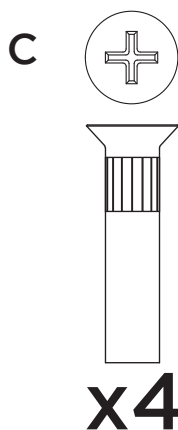
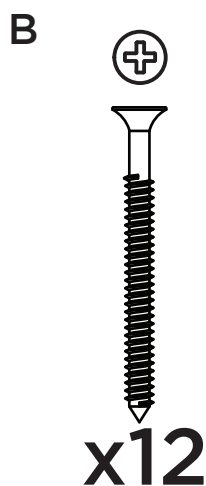
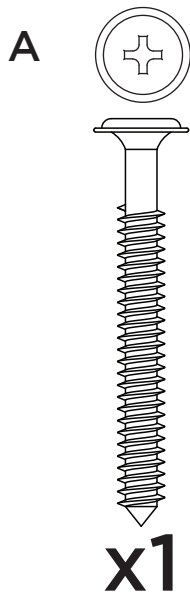

 Os parafusos (C/D) devem ser usados somente quando este módulo for acoplado a outro módulo componível Henn.

 Los tornillos (C/D) se debe utilizar sólo cuando el módulo está conectado a otro módulo componible Henn.

 Screws (C/D) are to be used only when this module is mated to another Henn buildable module.

Parafusos em escala
Tornillos escalados
Scaled screws **1:1**

LISTA DE PEÇAS | LISTA DE PIEZAS | LIST OF PIECES

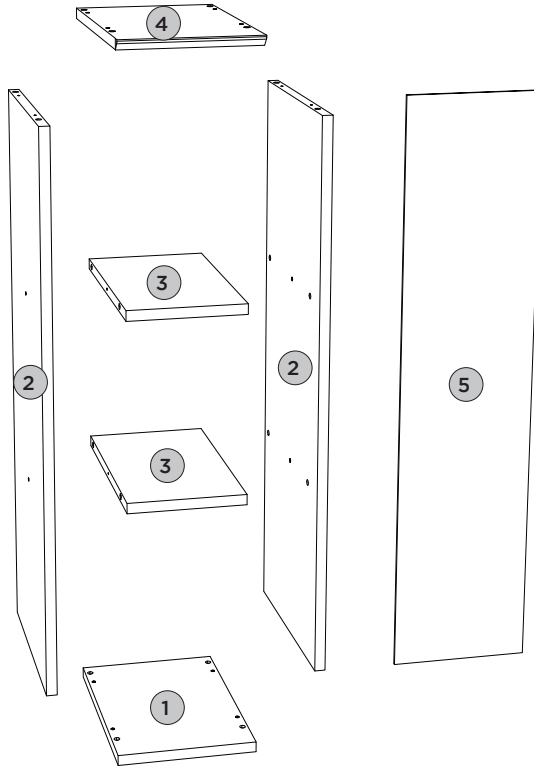

Item	Caja Caja Box	Qty Ctd Qty	Descrição Descripción Description	Dimensões (mm) Dimensiones (mm) Dimensions (mm)		
				Comprimento Largo Length	Largura Ancho Width	Espessura Grosor Thickness
1	1/1	01	BASE BASE BASE	295	200	15
2	1/1	02	LATERAL LATERAL SIDE	800	295	15
3	1/1	02	PRATELEIRA ESTANTE SHELF	293	169	15
4	1/1	01	TAMPO TAPA TOP	322	200	15
5	1/1	01	FUNDO FONDO BACKGROUND	824	193	3



PASSO 1

ITM/C637-

PEÇAS REQUERIDAS

2	LATERAL	x2
3	PRATELEIRA	x2

ACESSÓRIOS REQUERIDOS

F		16
L		

FERRAMENTAS NECESSÁRIAS

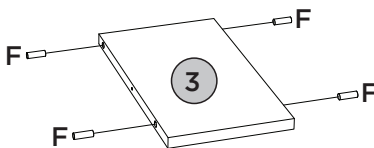
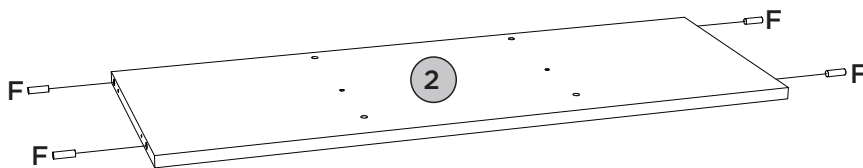

Utilizar o sachê de cola (L) em todas as cavilhas (F) do produto.

Con el pegamento sobre (L) en todos los pernos (F) producto.

Use the glue sachet (L) on all the pegs (F) of the product.



PASSO 2

ITM/C637-

PEÇAS REQUERIDAS

1	BASE	x1
2	LATERAL	x2
3	PRATELEIRA	x2
4	TAMPO	x1

ACESSÓRIOS REQUERIDOS

B			12
L			

FERRAMENTAS NECESSÁRIAS

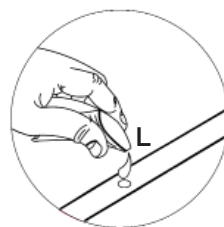
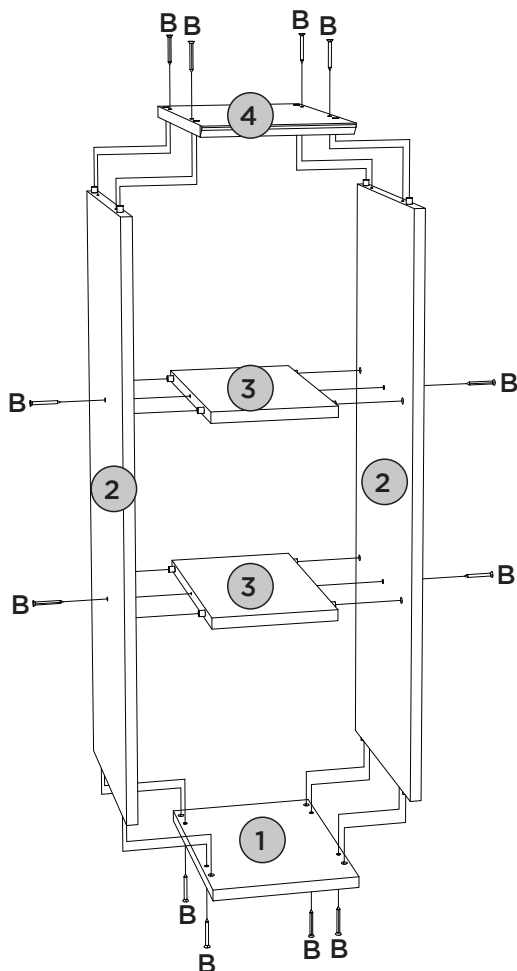
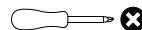

PASSO 3

ITM/C637-

PEÇAS REQUERIDAS

5	FUNDO	x1
---	-------	----

ACESSÓRIOS REQUERIDOS

G		24
---	--	----

FERRAMENTAS NECESSÁRIAS

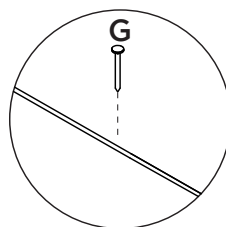
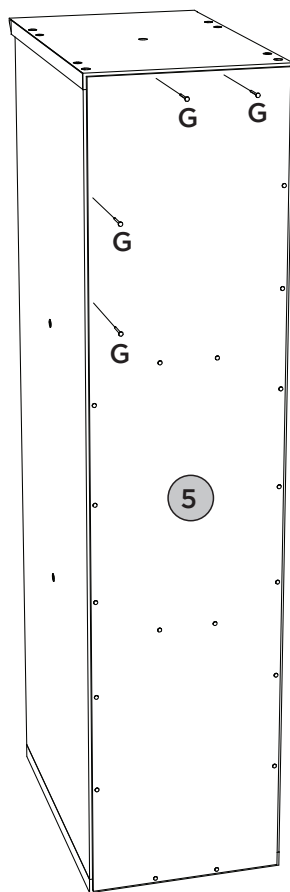
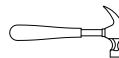

Fixar os pregos a uma distância de 100mm de um para outro.

Fijar las uñas a un distancia de 100mm uno a otro.

Fix the nails at a distance of 100mm from one to the other

ACESSÓRIOS REQUERIDOS

A		01
E		02
H		03
I		01
J		01
K		12

FERRAMENTAS NECESSÁRIAS

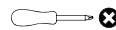

OU



Para parede: Ajustar no modo perfuração
Para peça (O4): Usar torque 5

Pesos máximos recomendados com carga distribuída
Peso máximo recomendado con la carga distribuida
Recommended maximum weight with distributed load.

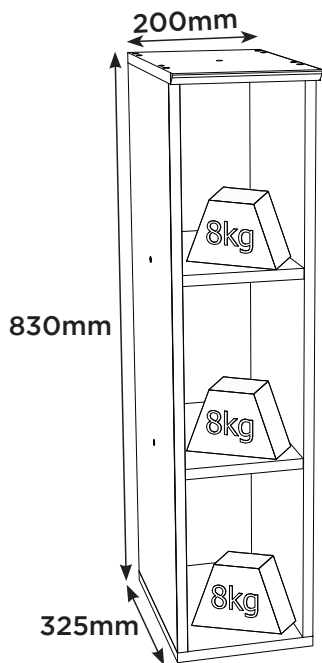

RECOMENDAÇÃO

Para fixar o móvel na parede usar o suporte de fixação (I), o parafuso 4,0x14mm CHT (E), a Bucha 8mm (H) e o parafuso 5,0x50mm FLA (A).

RECOMENDACIÓN

Para conectar el móvil a la pared con el soporte (I), tornillo 4,0 x14mm CHT (E), el casquillo de 8 mm (H) y el 5,0 x50mm tornillo FLA (A).

RECOMMENDATION

To fix the furniture to the wall use the fixing bracket (I), the 4,0x14mm CHT (E) screw, the 8mm bushing (H) and the 5,0x50mm FLA screw (A).

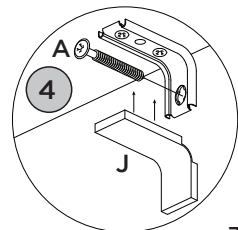
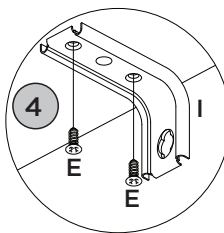
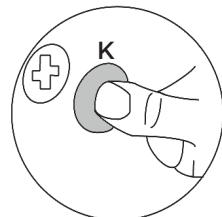

Producto Concluído
Producto terminado
Finished Product

