

# CO14201 - AÉREO 0,40M

Manual de Montagem  
Assembly Instructions  
Instrucción de Montaje

decibal<sup>®</sup>  
móveis

Produto Montado  
Producto final  
Assembled

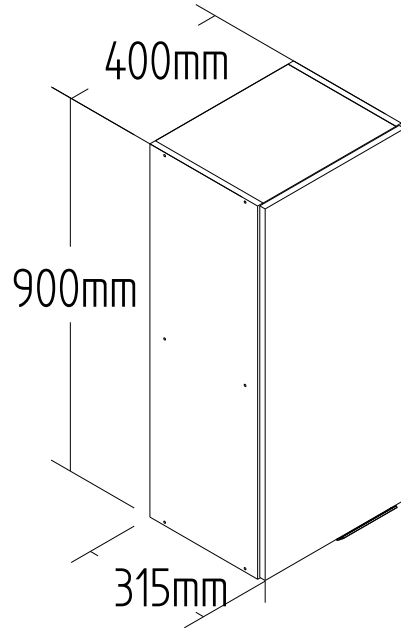

1°

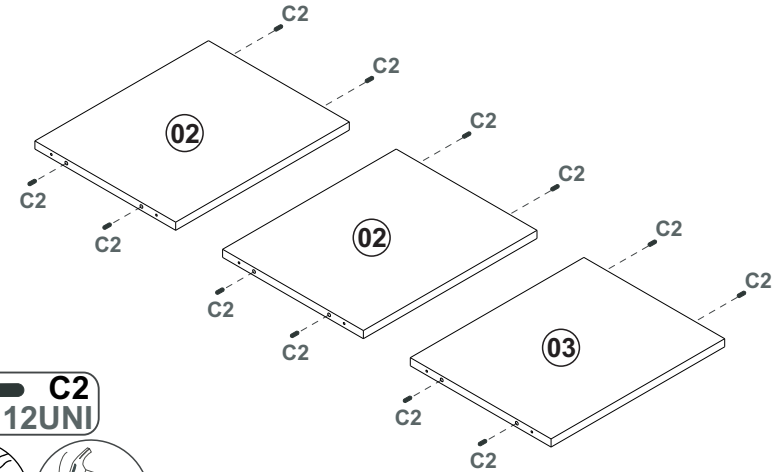

C2  
12UNI

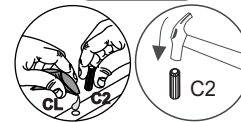

2°

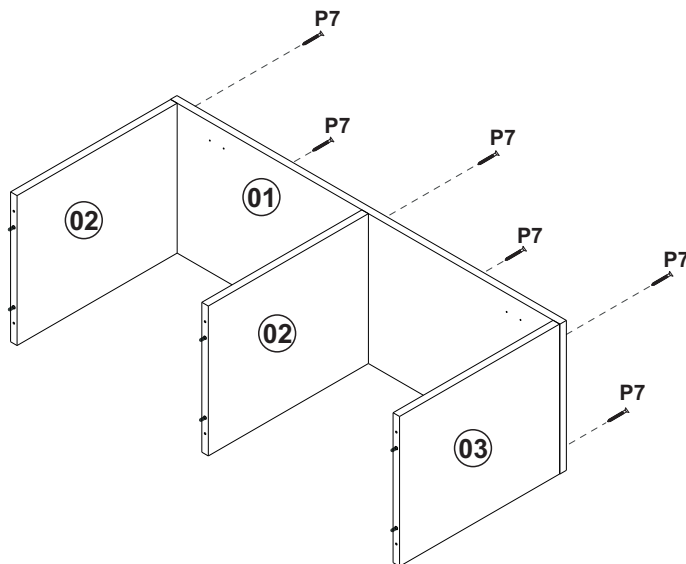

P7  
6 UNI



3°

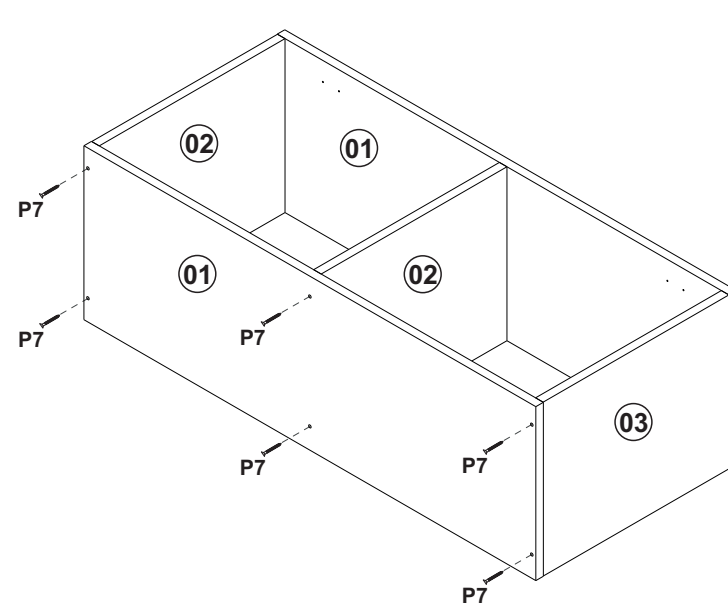

P7  
6 UNI



## 4º COSTA/REVÉS/BACK

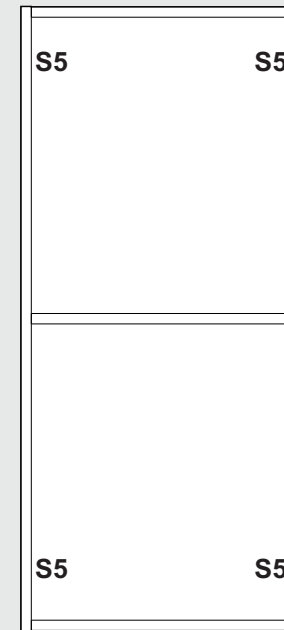
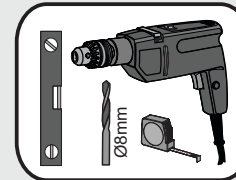
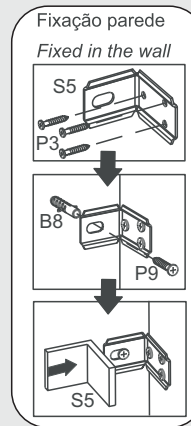
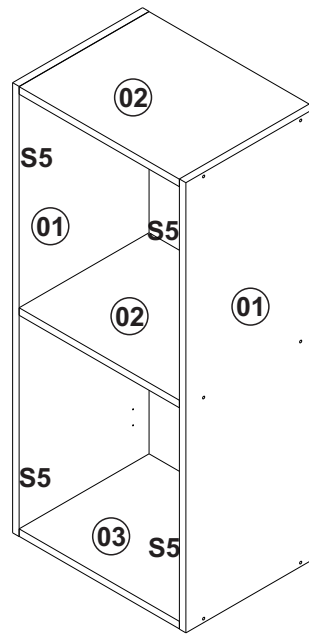
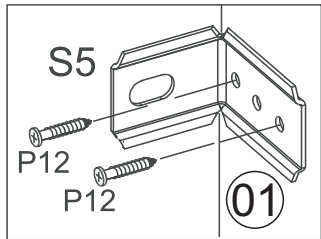

## 5º COSTA/REVÉS/BACK

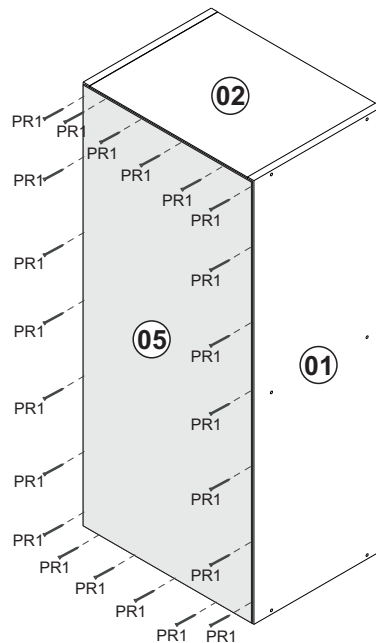
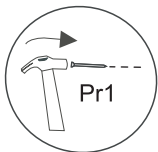

**\*PESO SUPORTADO.  
 \*PESO SOPORTADO.  
 \*WEIGHT SUPPORTED.**



# CO14201 - AÉREO 0,40M

Manual de Montagem  
Assembly Instructions  
Instrucción de Montaje

decibal<sup>®</sup>  
móveis

6°

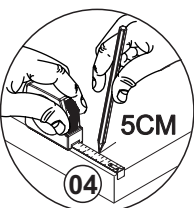
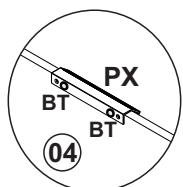
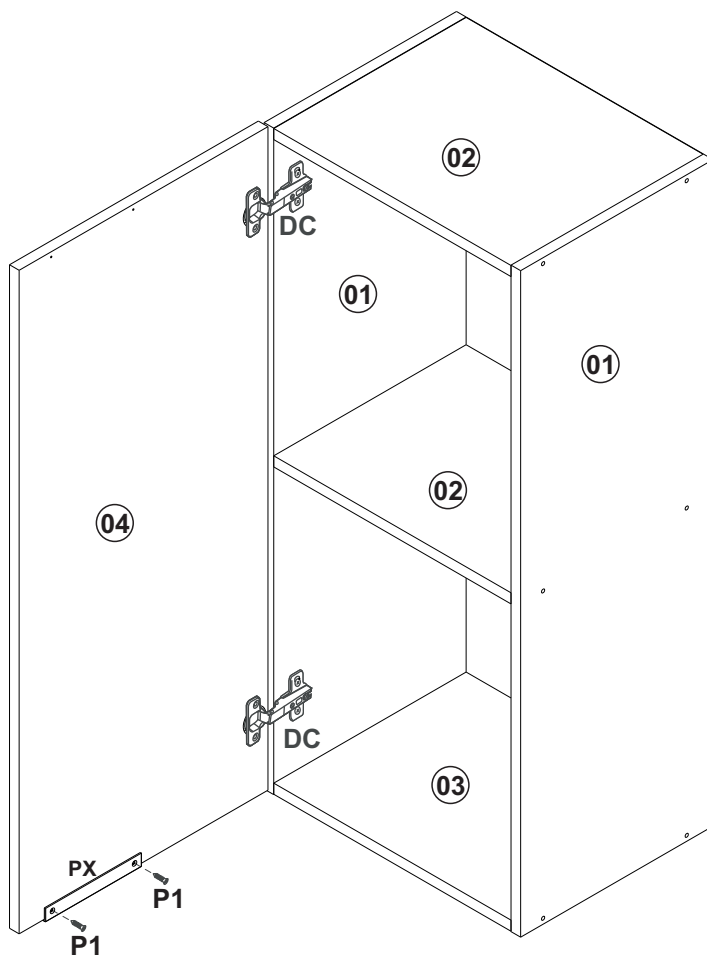

**ATENÇÃO!!!!**

MARCAÇÃO PRA O PRIMEIRO FURO DO PUXADOR  
MARCADO PARA EL PRIMER AGUJERO  
MARKING FOR THE FIRST HANDLE HOLE

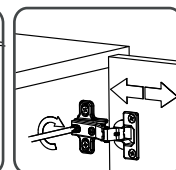
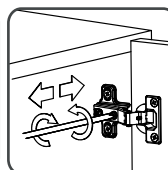
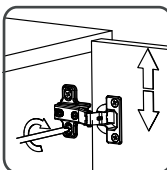
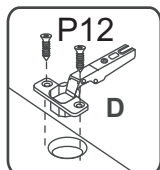
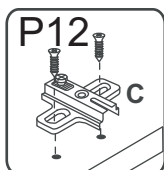

## Relação de Peças/ Relación de Piezas/Parts List

N°	CÓDIGO/CODE	DESCRIÇÃO/DESCRIPCIÓN/DESCRIPTION	QTD/CANT	VOL.	
1	0560916	LATERAL/LATERAL/SIDE	900X300X15MM	2	1
2	0560917	BASE SUP	300X370X15MM	2	1
3	0560915	BASE INF	300X370X15MM	1	1
4	0560918	PORTA/PUERTA/DOOR	896X388X15MM	1	1
5	0560919	COSTA/REVÉS/BACK	894X394X2, 8MM	1	1

[www.decibal.com.br](http://www.decibal.com.br)

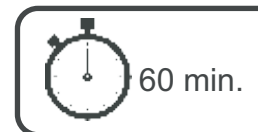

**ATENÇÃO!!!! montadores e consumidores**  
\* Ajustar o torque da parafusadeira para não danificar as peças escareando o parafuso \*  
**ATENCIÓN!!!! montadores e consumidores**  
\* Ajuste el torque del destornillador para no dañar las piezas avallando el tornillo \*  
**ATTENTION!!!! assemblers and consumers**  
\* Adjust the torque of the screwdriver so as not to damage the parts by countersinking the screw \*

Ferramentas necessárias  
Necessary tools  
Herramientas necesarias

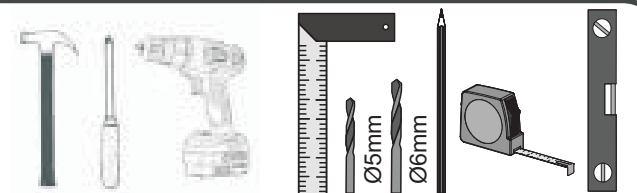

**ATENÇÃO!!!! montadores e consumidores**  
\* Para limpar o móveis utilize somente um pano úmido (umedecido em água pura ou água com sabão neutro). Depois, passe um pano seco. Evite a umidade excessiva.  
\* Evite usar álcool, água sanitária, detergente e outros produtos químicos, mesmo diluídos em água. Não utilize produtos abrasivos de nenhuma espécie

**ATENCIÓN!!!! montadores e consumidores**  
\* Para limpiar el mueble utilice solamente un paño húmedo (humedecido con agua limpia o con un jabón suave).  
Acontinución, utilice un paño seco. Evite el exceso de humedad.  
\* Evite uso de alcohol, hipocloridro solución basada, detergente y otros productos químicos, mismo diluidos en agua. No utilice productos abrasivos de ningún tipo.







**ATTENTION!!!! assemblers and consumers**  
\*To clean the furniture, use only a damp cloth (humidify it only in pure water ou water and neutral soap).After, use a dry cloth.Avoid excessive humidity.  
\*Avoid using alcohol, bleach, detergent and other chemical products, even diluted in water. Do not use any kind of abrasive cleaning agents to clean the furniture.  
The use of such products may jeopardize the ?nal characteristics of the furniture.

# CO14201 - AÉREO 0,60M







Manual de Montagem  
Assembly Instructions  
Instrucción de Montaje

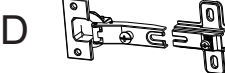

## Ferragens/ Herrajes/ Hardware

		escala (1:1)	
LEGENDA	DESCRIÇÃO/DESCRIPCIÓN/DESCRIPTION	CÓDIGO	QUANT.
<b>P7</b>	 PARAFUSO/TORNILLO/SCREW 4X45	01318	<b>12</b>
<b>PR1</b>	 PREGO/CLAVO/NAIL 10X10	01330	<b>30</b>
<b>C2</b>	 CAVILHA/TARUGO/DOWEL 6X30 MM	01211	<b>14</b>
<b>P1</b>	 PARAFUSO/TORNILLO/SCREW 3,5X12	01328	<b>02</b>
<b>PU</b>	 PARAFUSO UNIÃO/UNIÓN DETORNILLO /SCREW UNION	01495	<b>02</b>
<b>P12</b>	 PARAFUSO/TORNILLO/SCREW 3,5X13	09927	<b>20</b>
<b>P9</b>	 PARAFUSO/TORNILLO/SCREW 6X50	03827	<b>04</b>

## escala (N/A)

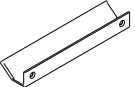
LEGENDA	DESCRIÇÃO/DESCRIPCIÓN/DESCRIPTION	CÓDIGO	QUANT.
<b>CL</b>	 COLA/PEGAMENTO/GLUE	01213	<b>01</b>
<b>ET</b>	 ETIQUETA LOGO DECIBAL/LABEL DECIBAL	01312	<b>01</b>
<b>B1</b>	 BUCHA/BUJE/BUCHING ( 8mm)	01311	<b>04</b>
<b>DC</b>	 DOBRADIÇA/BISAGRA/HINGE D=35mm C=Alta	12615	<b>02</b>
<b>S5</b>	 SUPORTE AÉREO/APOYO AÉREO/AIR SUPPORT	03828	<b>04</b>
<b>AD</b>	ADESIVO/ADHESIVO/ADHESIVE 	15mm	<b>12</b>
<b>BT</b>	 BATENTE/BATIENTE DE SILICONA/SILICONE STOP 8MM	02921	<b>02</b>
<b>PX</b>	PUXADOR/PEGADOR /HANDLE CHAMPANHE( AKEO 128MM) 	12611	<b>01</b>

Medida em mm

