

CO6300 AÉREO 1,20M

Manual de Montagem
Assembly Instructions
Instrucción de Montaje

decibal®

Produto Montado
Producto final
Assembled

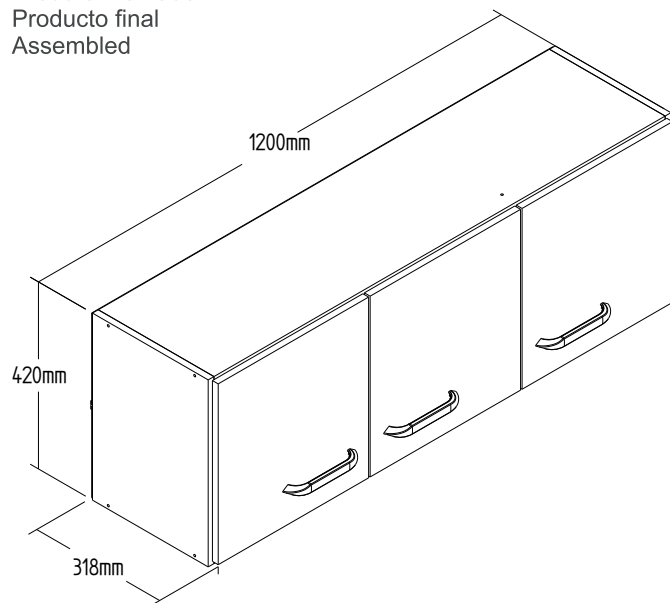

1º

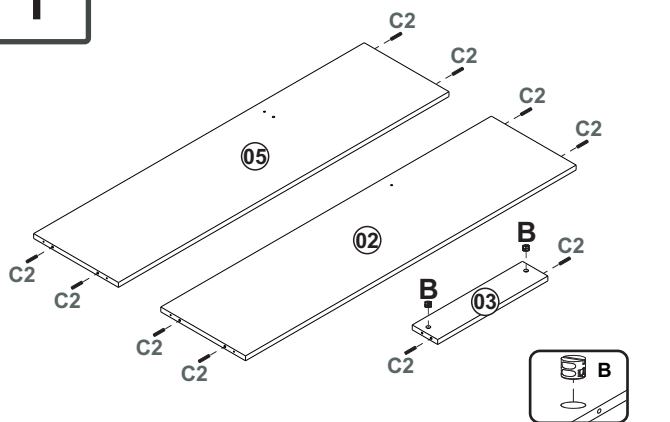

2º

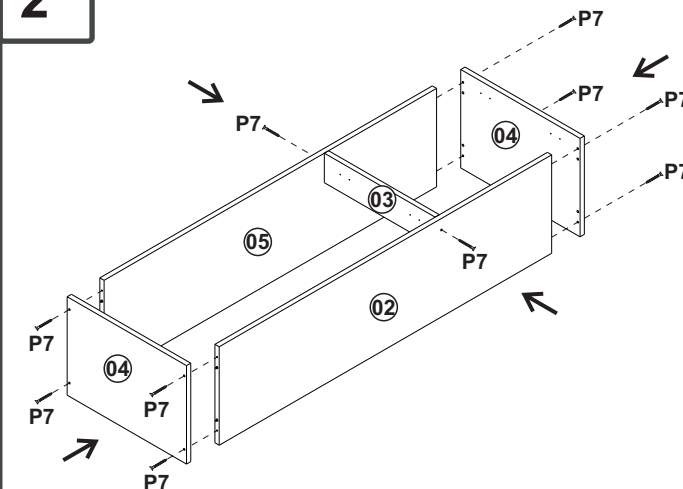

3º COSTA/REVÉS/BACK

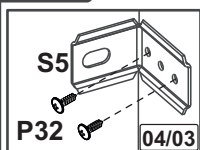

P32
10 UNI

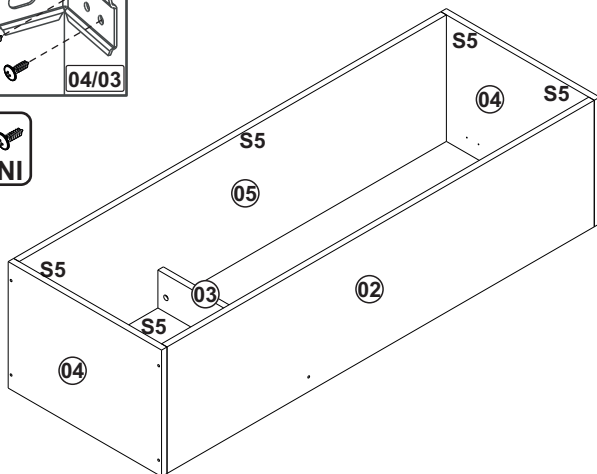

4º COSTA/REVÉS/BACK

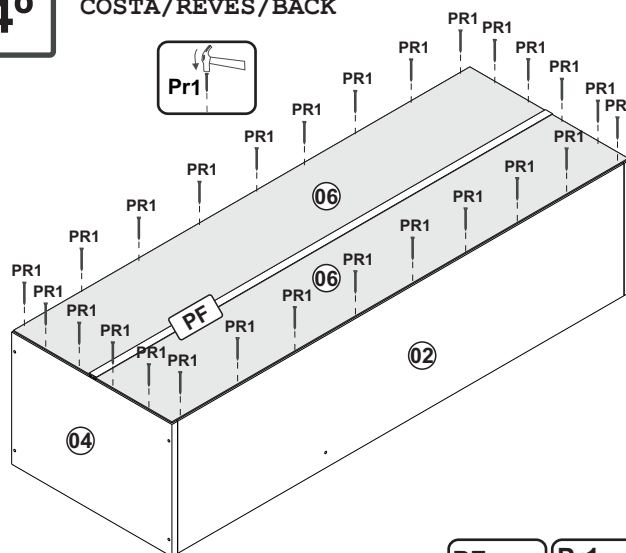

PF (01 UNI), Pr1 (40 UNI)

5º



PESO SUPORTADO/PESO SOPORTADO.
WEIGHT SUPPORTED.

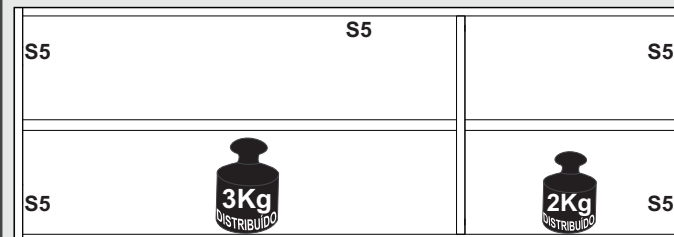

FIXAÇÃO NA PAREDE/ FIJACIÓN EN LA PARED / FIXING ON THE WALL

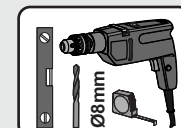
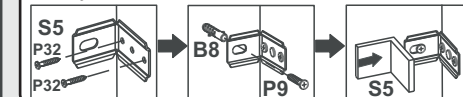

CO6300 AÉREO 1,20M

Manual de Montagem
Assembly Instructions
Instrucción de Montaje

decibal®

6°

P32
24 UNI

P13
06 UNI

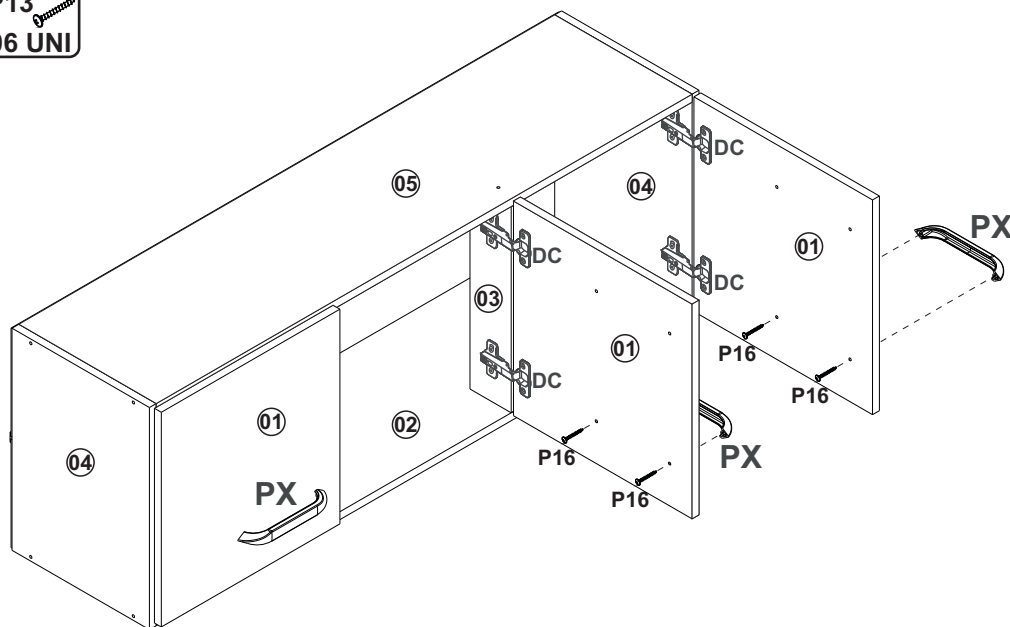

D  **C** 
DOBRADIÇA/BISAGRA/HINGE D=26mm C=5

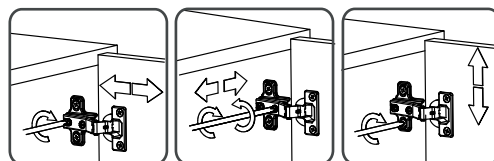
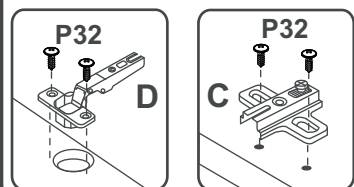

Relação de Peças/ Relación de Piezas/Parts List

N°	CÓDIGO/CODE	DESCRIÇÃO/DESCRIPCIÓN/DESCRIPTION	QTD/CANT	VOL.	
1	0569829	PORTA/PUERTA/DOOR	406X390X15MM	3	1
2	0569830	BASE INF	1170X300X15MM	1	1
3	0569833	PILASTRA/PILASTER	390X90X15MM	1	1
4	0569831	LATERAL/LATERAL/SIDE	420X300X15MM	2	1
5	0569834	BASE SUP	1170X300X15MM	1	1
6	0569835	COSTA/REVÉS/BACK	1196X203X2,8MM	2	1

ATENÇÃO!!!! montadores e consumidores
* Ajustar o torque da parafusadeira para não danificar as peças escareando o parafuso *

ATENCIÓN!!!! montadores e consumidores
* Ajuste el torque del destornillador para no dañar las piezas avallando el tornillo *

ATTENTION!!!! assemblers and consumers
* Adjust the torque of the screwdriver so as not to damage the parts by countersinking the screw *

Ferramentas necessárias
Necessary tools
Herramientas necesarias

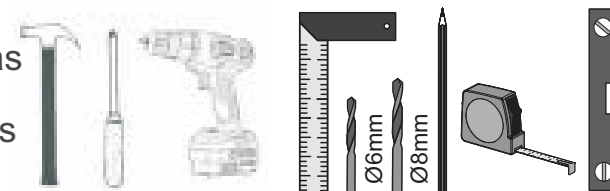

www.decibal.com.br

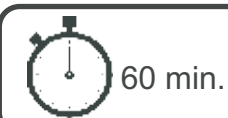

 1 montador
1 ajustador
1 Fitter

ATENÇÃO!!!! montadores e consumidores
* Para limpar o móveis utilize somente um pano úmido (umedecido em água pura ou água com sabão neutro). Depois, passe um pano seco. Evite a umidade excessiva.
* Evite usar álcool, água sanitária, detergente e outros produtos químicos, mesmo diluídos em água.
* Não utilize produtos abrasivos de nenhuma espécie

ATENCIÓN!!!! montadores e consumidores
* Para limpiar el mueble utilice solamente un paño húmedo (humedecido con agua limpia o con un jabón suave). A continuación, utilice un paño seco. Evite el exceso de humedad.
* Evite uso de alcohol, hipoclorídrico solución basada, detergente y otros productos químicos, mismo diluidos en agua. No utilice productos abrasivos de ningún tipo.







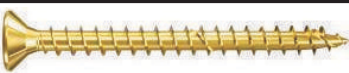

ATTENTION!!!! assemblers and consumers
* To clean the furniture, use only a damp cloth (humidify it only in pure water ou water and neutral soap). After, use a dry cloth. Avoid excessive humidity.
* Avoid using alcohol, bleach, detergent and other chemical products, even diluted in water. Do not use any kind of abrasive cleaning agents to clean the furniture.
The use of such products may jeopardize the ?nal characteristics of the furniture.

CO6300 AÉREO 1,20M







Manual de Montagem
Assembly Instructions
Instrucción de Montaje

decibal®

Escala (1:1)

LEGENDA	DESCRIÇÃO/DESCRIPCIÓN/DESCRIPTION	CÓDIGO	QUANT.
P7	 PARAFUSO/TORNILLO/SCREW 4X45	01318	10
P9	 PARAFUSO/TORNILLO/SCREW 6X50	03827	05
P16	 PARAFUSO/TORNILLO/SCREW 3.5X25	09955	06
P32	 PARAFUSO/TORNILLO/SCREW 4X14	12412	34
PR1	 PREGO/CLAVO/NAIL 10X10	01330	40
C2	 CAVILHA/TARUGO/DOWEL 6X30 MM	01211	12
PU	 PARAFUSO UNIÃO/UNIÓN DETORNILLO /SCREW UNION	01495	02
B	 BUCJA/BUJE/BUCHING	02734	02

Escala (N/A)

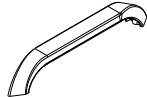
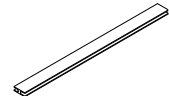
LEGENDA	DESCRIÇÃO/DESCRIPCIÓN/DESCRIPTION	CÓDIGO	QUANT.
CL	 COLA/PEGAMENTO/GLUE	01213	01
ET	 ETIQUETA LOGO DECIBAL/LABEL DECIBAL	01312	01
B8	 BUCHA/BUJE/BUCHING (8mm)	01311	05
DC	 DOBRADIÇA/BISAGRA/HINGE D=26mm C=5	01268	06
S5	 SUPORTE AÉREO/APOYO AÉREO/AIR SUPPORT	03828	05
AD	 ADESIVO/ADHESIVO/ADHESIVE 15mm		09
PX	 PUXADOR/PEGADOR /HANDLE DUBAI 160MM CHAPAGNE ESCURO	13305	03
PF	 PERFIL/PROFILE/PERFIL 1196MM	13307	01

Medida em mm

