

CO7301 - AÉREO 1,20 M

Manual de Montagem
 Assembly Instructions
 Instrucción de Montaje

decibal®

Produto Montado
 Producto final
 Assembled

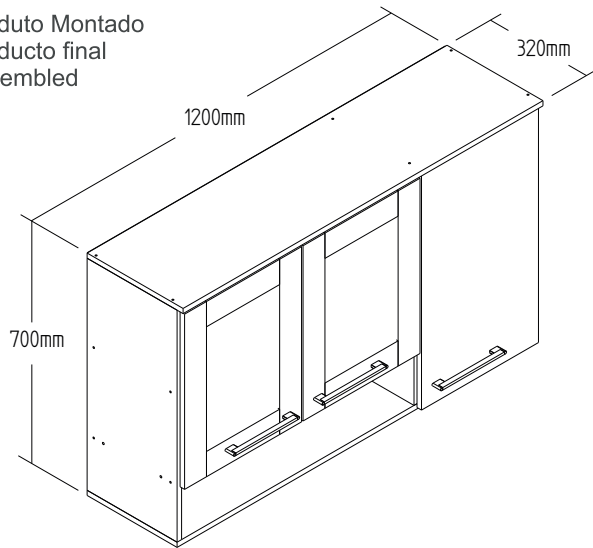

Verificar o lado desejado antes de efetuar a montagem
 Check the desired side before mounting
 Compruebe el lado deseado antes de montar

01°

C2
 24 UNI

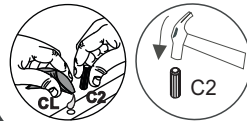
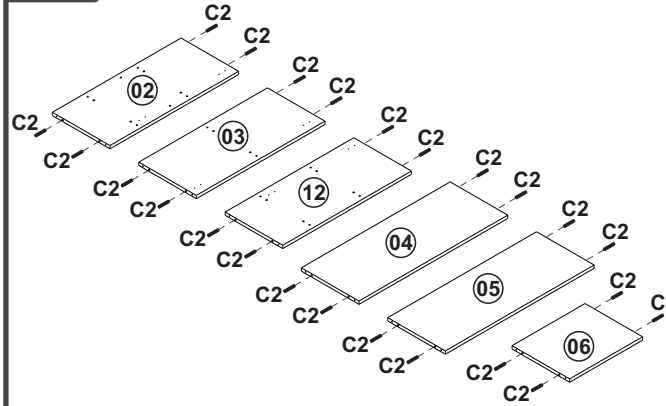

02°

P7
 2 UNI

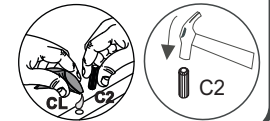
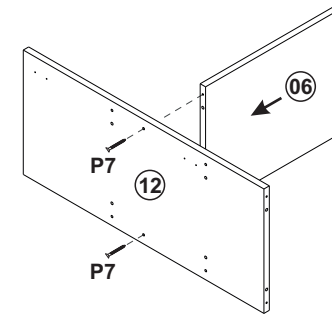

03°

P7
 4 UNI

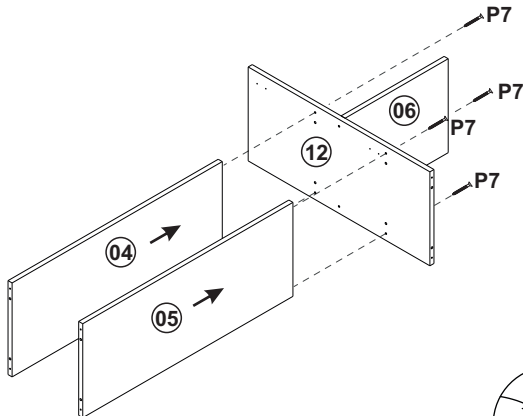

04°

P7
 6 UNI

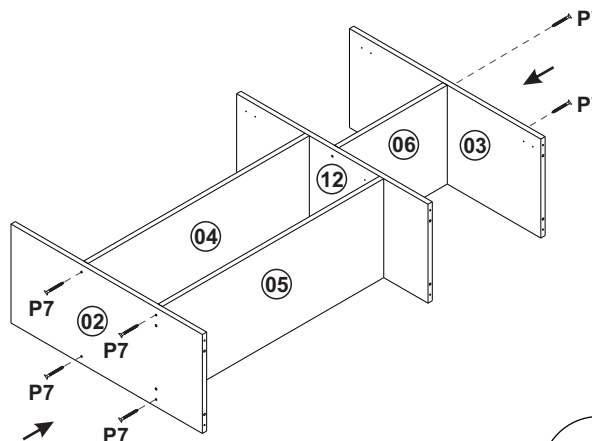

05°

P7
 12 UNI

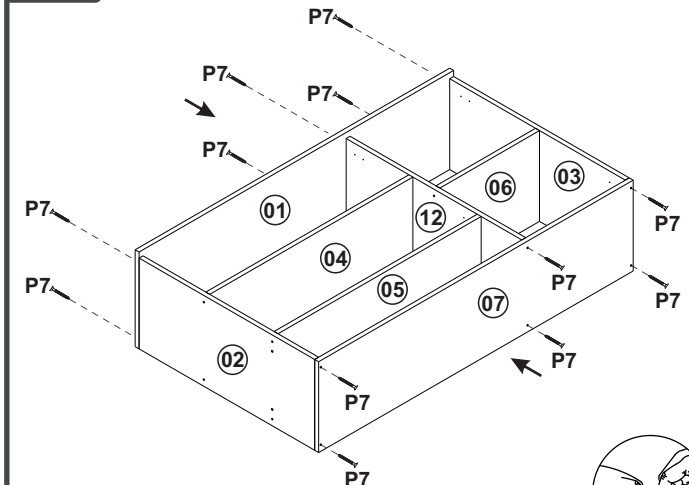

CO7301 - AÉREO 1,20 M

Manual de Montagem
 Assembly Instructions
 Instrucción de Montaje

decibal®

6°

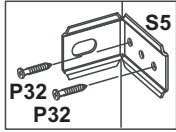

COSTA/REVÉS/BACK

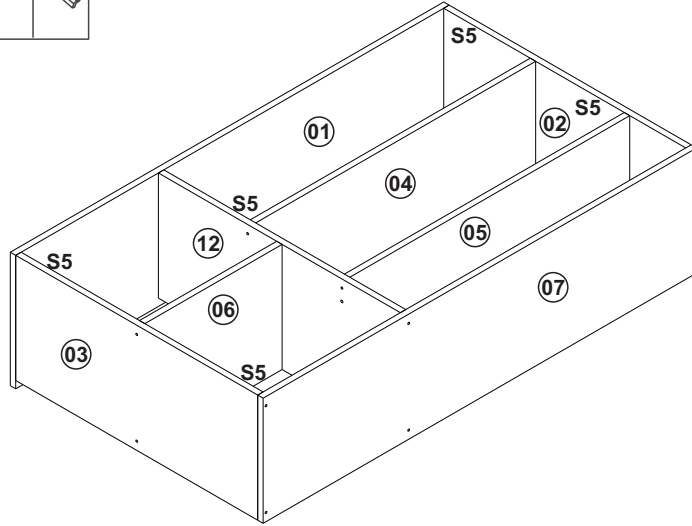

7°

COSTA/REVÉS/BACK

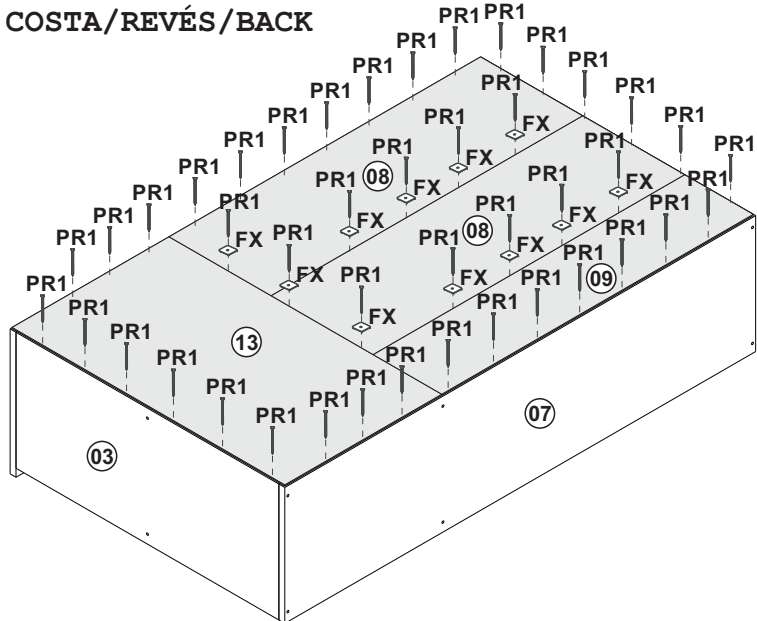

8°

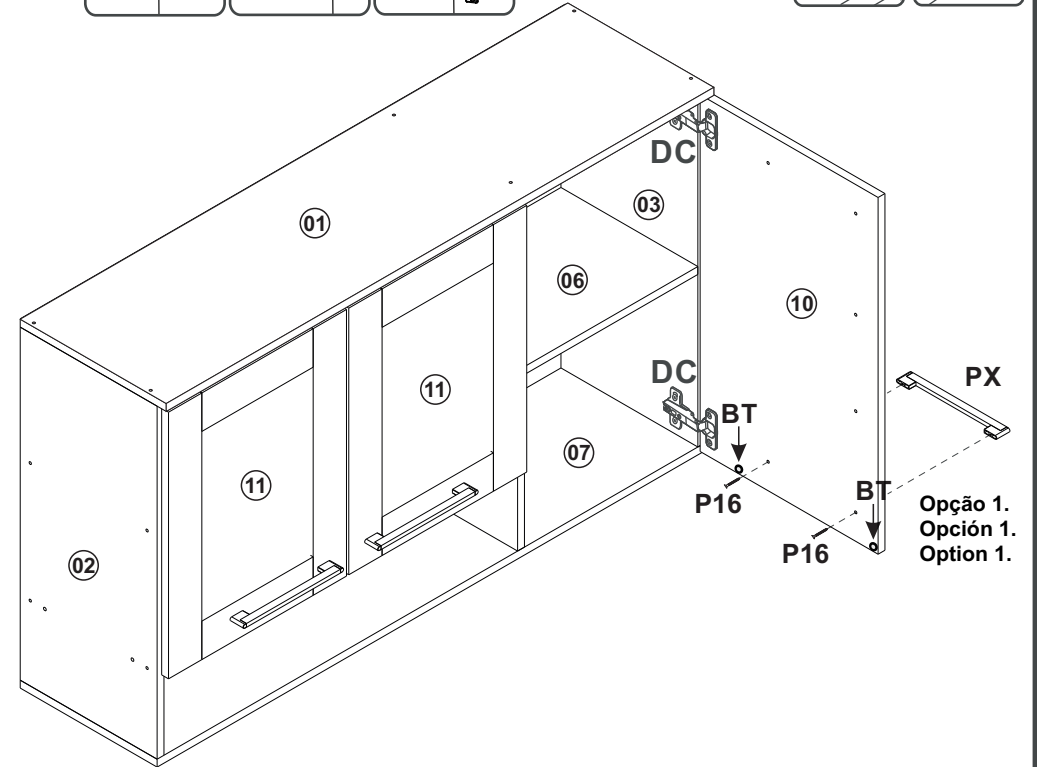
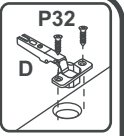
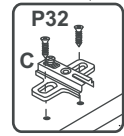
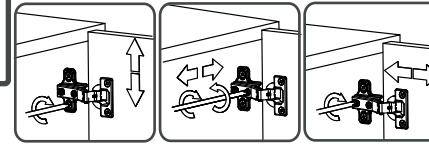

Opção 1.
 Opción 1.
 Option 1.

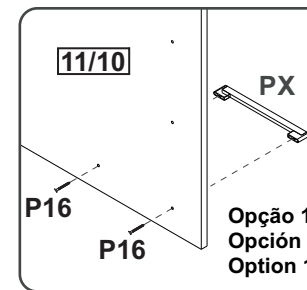

Opção 1.
 Opción 1.
 Option 1.

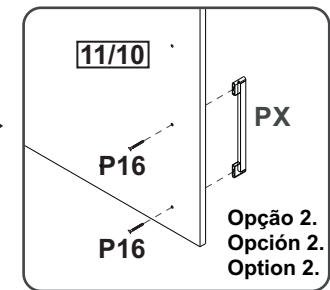
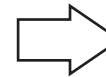

Opção 2.
 Opción 2.
 Option 2.



Atenção! verificar a posição adequada do puxador antes de efetuar a montagem.
 ¡Atención! Compruebe la posición adecuada del mango antes del montaje.
 Attention! Check the proper position of the handle before assembling.

CO7301 - AÉREO 1,20 M

Manual de Montagem
Assembly Instructions
Instrucción de Montaje

decibal[®]
móveis

Relação de Peças/ Relación de Piezas/Parts List

9°



**PESO SUPORTADO.
PESO SOPORTADO.
WEIGHT SUPPORTED.**

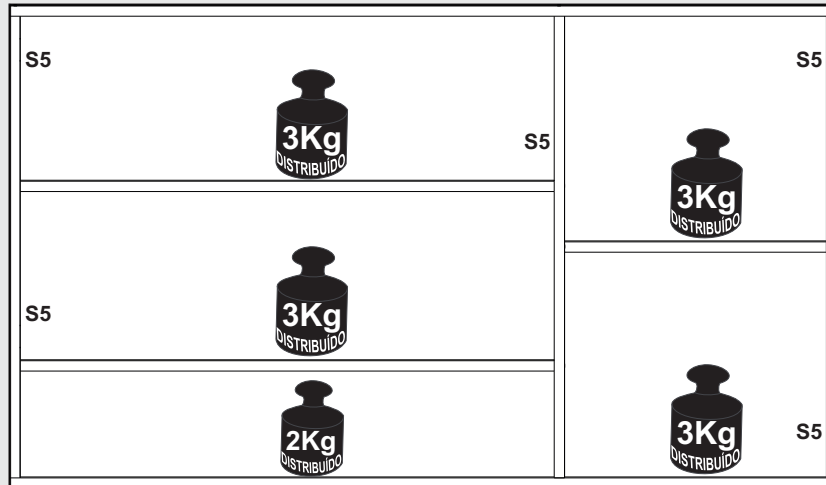

FIXAÇÃO NA PAREDE/FIJAÇÃO EN LA PARED/FIXING ON THE WALL

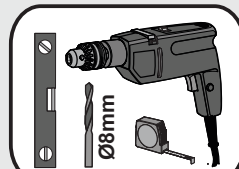
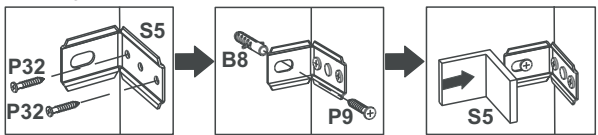

ATENÇÃO!!!! montadores e consumidores

* Para limpar o móveis utilize somente um pano úmido (umedecido em água pura ou água com sabão neutro). Depois, passe um pano seco. Evite a umidade excessiva.

* Evite usar álcool, água sanitária, detergente e outros produtos químicos, mesmo diluídos em água.

* Não utilize produtos abrasivos de nenhuma espécie

ATENCIÓN!!!! montadores e consumidores

* Para limpiar el mueble utilice solamente un paño húmedo (humedecido con agua limpia o con un jabón suave). A continuación, utilice un paño seco. Evite el exceso de humedad.

* Evite uso de alcohol, hipoclorídeo solución basada, detergente y otros productos químicos, mismo diluídos en agua. No utilice productos abrasivos de ningún tipo.

ATTENTION!!!! assemblers and consumers

* To clean the furniture, use only a damp cloth (humidify it only in pure water ou water and neutral soap). After, use a dry cloth. Avoid excessive humidity.

* Avoid using alcohol, bleach, detergent and other chemical products, even diluted in water. Do not use any kind of abrasive cleaning agents to clean the furniture.

The use of such products may jeopardize the final characteristics of the furniture.

N°	CÓDIGO/CODE	DESCRIÇÃO/DESCRIPCIÓN/DESCRIPTION	QTD/CANT	VOL.	
1	0569426	BASE SUP	1200X320X15MM	1	1
2	0569431	LATERAL ESQ/LATERAL/SIDE	670X300X15MM	1	1
3	0569432	LATERAL DIR/LATERAL/SIDE	670X300X15MM	1	1
4	0569429	PRATELEIRA MAIOR SUP/ESTANTE/SHELF	775X300X15MM	1	1
5	0569428	PRATELEIRA MAIOR/ESTANTE/SHELF	775X300X15MM	1	1
6	0569430	PRATELEIRA/ESTANTE/SHELF	380X300X15MM	1	1
7	0569427	BASE	1200X300X15MM	1	1
8	0569435	COSTA SUP MAIOR/REVÉS/BACK	794X260X2,8MM	2	1
9	0569436	COSTA SUP/REVÉS/BACK	794X175X2,8MM	1	1
10	0569434	PORTA DIREITA/PUERTA/DOOR	677X390X15MM	1	2
11	0569438	PORTA DE VIDRO/PUERTA/DOOR	506X390X15MM	2	2
12	0569433	DIVISORIA/DIVIDER	670X300X15MM	1	2
13	0569437	COSTA LATERAL/REVÉS/BACK	695X400X2,8MM	1	2

ATENÇÃO!!!! montadores e consumidores

* Ajustar o torque da parafusadeira para não danificar as peças escareando o parafuso *

ATENCIÓN!!!! montadores e consumidores

* Ajuste el torque del destornillador para no dañar las piezas avallanando el tornillo *

ATTENTION!!!! assemblers and consumers

* Adjust the torque of the screwdriver so as not to damage the parts by countersinking the screw *

Ferramentas necessárias

Necessary tools

Herramientas necesarias

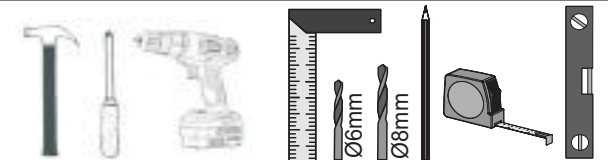

www.decibal.com.br

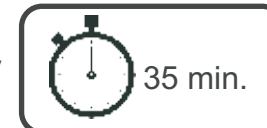

35 min.



















2 montador
2 ajustador
2 Fitter

CO7301 - AÉREO 1,20 M

Manual de Montagem
Assembly Instructions
Instrucción de Montaje

decibal[®]
móveis

Escala (1:1)				Escala (N/A)			
LEGENDA	Ferragens/ Herrajes/ Hardware DESCRIÇÃO/DESCRIPCIÓN/DESCRIPTION	CÓDIGO	QUANT.	LEGENDA	DESCRIÇÃO/DESCRIPCIÓN/DESCRIPTION	CÓDIGO	QUANT.
P7	 PARAFUSO/TORNILLO/SCREW 4X45	01318	24	CL	 COLA/PEGAMENTO/GLUE	01213	01
P9	 PARAFUSO/TORNILLO/SCREW 6X50	03827	05	ET	 ETIQUETA LOGO DECIBAL/LABEL DECIBAL	01312	01
P16	 PARAFUSO/TORNILLO/SCREW 3,5X25	09955	06	B8	 BUCHA/BUJE/BUCHING (8mm)	01311	05
P32	 PARAFUSO/TORNILLO/SCREW 4X14	12412	46	S5	 SUPORTE AÉREO/APOYO AÉREO/AIR SUPPORT	03828	05
C2	 CAVILHA/TARUGO/DOWEL 6X30 MM	01211	25	FX	 FIXADOR COSTA/FIJADOR FONDO/FIXER COAST	01331	20
PU	 PARAFUSO UNIÃO/UNIÓN DETORNILLO /SCREW UNION	01495	02	AD	 ADESIVO/ADHESIVO/ADHESIVE	15mm	14
PR1	 PREGO/CLAVO/NAIL 10X10	01330	75	BT	 BATENTE/BATIENTE DE SILICONA/SILICONE STOP 8MM	02921	06
				DC	 DOBRADIÇA/BISAGRA/HINGE D=35mm C= Alta	12615 (Amortecimento)	06
				PX	 PUXADOR/PEGADOR /HANDLE SEVILHA NEW GOLD 192 MM	13106	03

Medida em mm

