

CO7111 - AÉREO 0,80M

Manual de Montagem
 Assembly Instructions
 Instrucción de Montaje

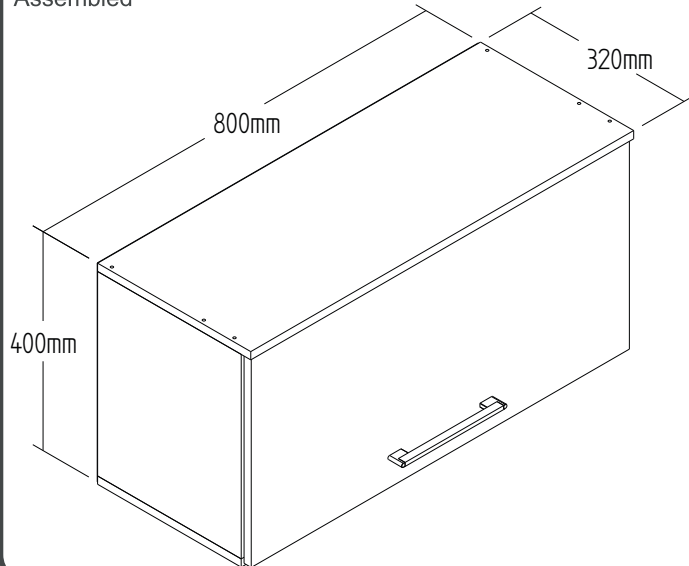

Produto Montado
 Producto final
 Assembled



1º

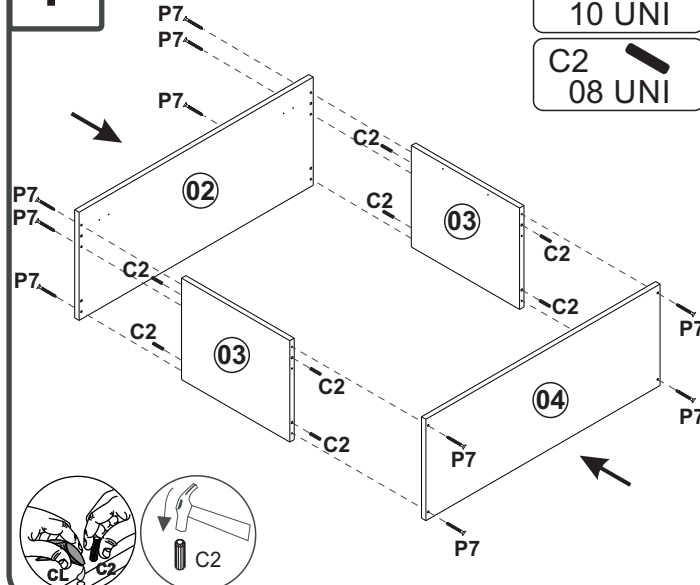

2º

COSTA/REVÉS/BACK

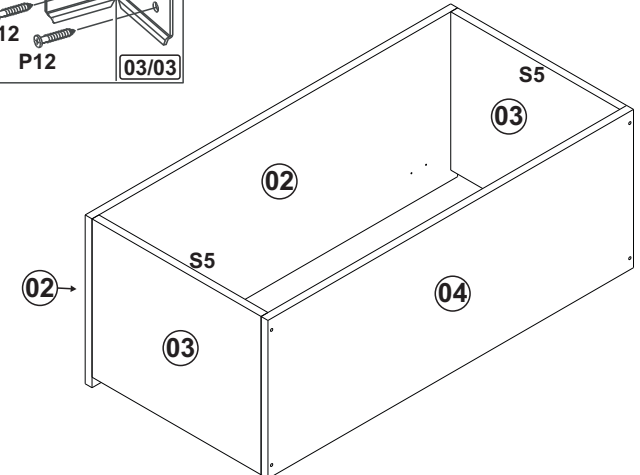
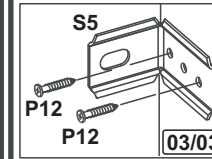

3º

COSTA/REVÉS/BACK

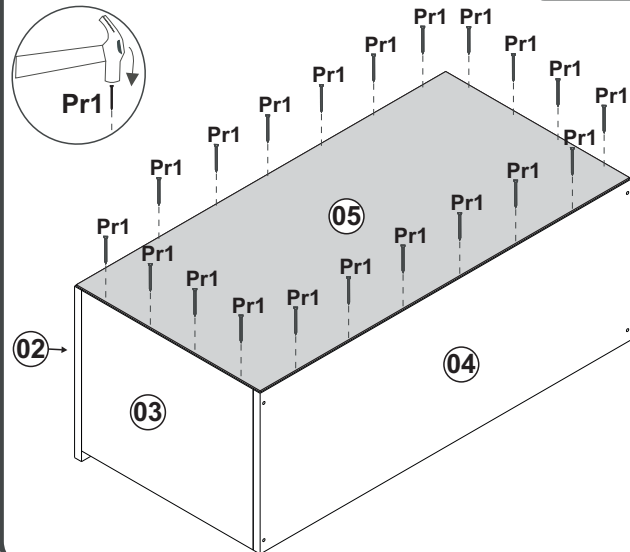
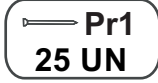

4º



5º



PESO SUPORTADO /
 PESO SOPORTADO /
 WEIGHT SUPPORTED

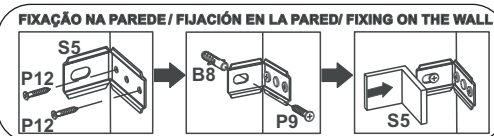
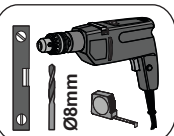
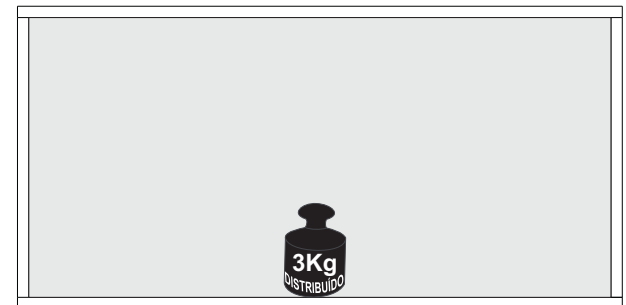

CO7111 - AÉREO 0,80M

Manual de Montagem
Assembly Instructions
Instrucción de Montaje

decibal[®]
móveis

6°

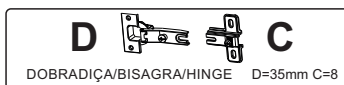
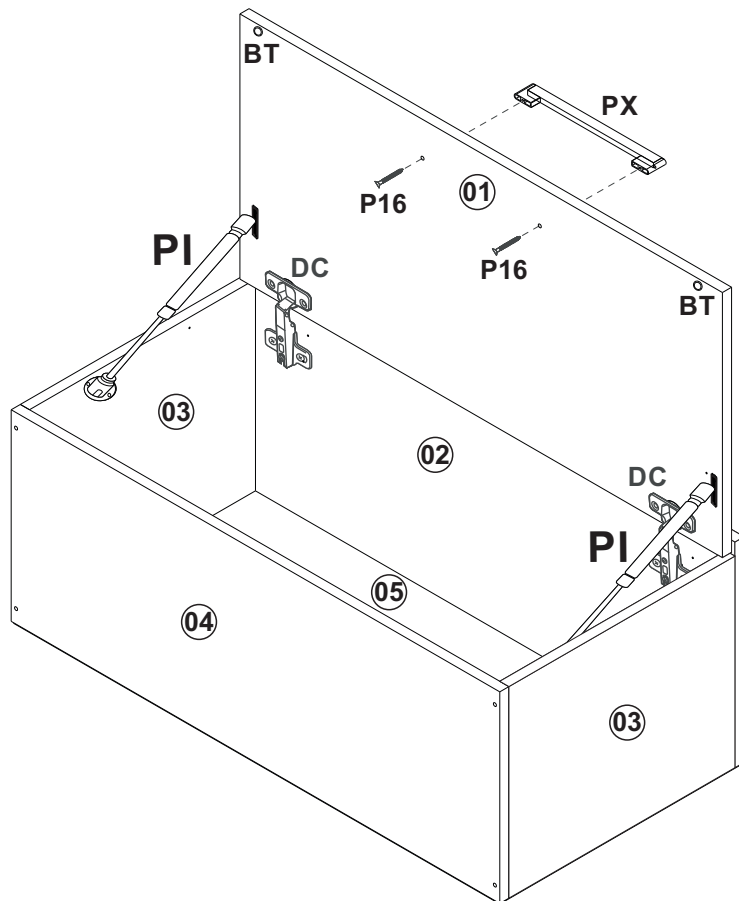
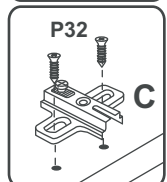
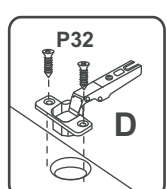
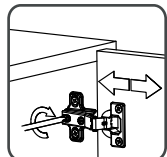
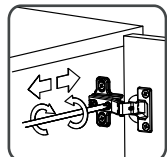
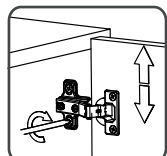
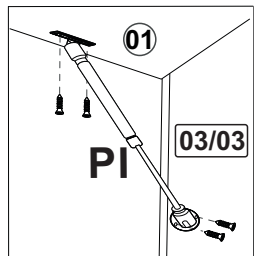

Relação de Peças/ Relación de Piezas/Parts List

N°	CÓDIGO/CODE	DESCRIÇÃO/DESCRIPCIÓN/DESCRIPTION	QTD/CANT	VOL.
1	0569123	PORTA/ PUERTA/DOOR	780X380X15MM	1
2	0569120	BASE SUP	800X320X15MM	1
3	0569122	LATERAL/ LATERAL/SIDE	300X370X15MM	2
4	0569121	BASE INF	800X300X15MM	1
5	0569124	COSTA/REVÉS/BACK	796X396X2,8MM	1

ATENÇÃO!!!! montadores e consumidores
* Ajustar o torque da parafusadeira para não danificar as peças escareando o parafuso *

ATENCIÓN!!!! montadores e consumidores
* Ajuste el torque del destornillador para no dañar las piezas avallanando el tornillo *

ATTENTION!!!! assemblers and consumers
* Adjust the torque of the screwdriver so as not to damage the parts by countersinking the screw *

www.decibal.com.br

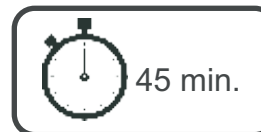

Ferramentas necessárias
Necessary tools
Herramientas necesarias

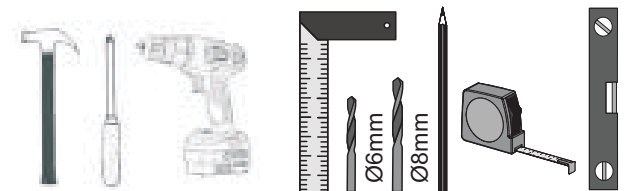

ATENÇÃO!!!! montadores e consumidores
* Para limpar o móveis utilize somente um pano úmido (umedecido em água pura ou água com sabão neutro). Depois, passe um pano seco. Evite a umidade excessiva.
* Evite usar álcool, água sanitária, detergente e outros produtos químicos, mesmo diluídos em água. Não utilize produtos abrasivos de nenhuma espécie

ATENCIÓN!!!! montadores e consumidores
* Para limpiar el mueble utilice solamente un paño húmedo (humedecido con agua limpia o con un jabón suave).
A continuación, utilice un paño seco. Evite el exceso de humedad.
* Evite uso de alcohol, hipocloridoro solución basada, detergente y otros productos químicos, mismo diluídos en agua. No utilice productos abrasivos de ningún tipo.













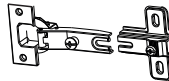

ATTENTION!!!! assemblers and consumers
* To clean the furniture, use only a damp cloth (humidify it only in pure water ou water and neutral soap).After, use a dry cloth.Avoid excessive humidity.
* Avoid using alcohol, bleach, detergent and other chemical products, even diluted in water. Do not use any kind of abrasive cleaning agents to clean the furniture.
The use of such products may jeopardize the ?nal characteristics of the furniture.

CO7111 - AÉREO 0,80M

Manual de Montagem
Assembly Instructions
Instrucción de Montaje



Ferragens/ Herrajes/ Hardware

		escala (1:1)		escala (N/A)			
LEGENDA	DESCRIÇÃO/DESCRIPCIÓN/DESCRIPTION	CÓDIGO	QUANT.	LEGENDA	DESCRIÇÃO/DESCRIPCIÓN/DESCRIPTION	CÓDIGO	QUANT.
P7	 PARAFUSO/TORNILLO/SCREW 4X45	01318	10	CL	 COLA/PEGAMENTO/GLUE	01213	01
PR1	 PREGO/CLAVO/NAIL 10X10	01330	25	ET	 ETIQUETA LOGO DECIBAL/LABEL DECIBAL	01312	01
C2	 CAVILHA/TARUGO/DOWEL 6X30 MM	01211	10	B1	 BUCHA/BUJE/BUCHING (8mm)	01311	02
P16	 PARAFUSO/TORNILLO/SCREW 3,5X25	09955	02	DC	 DOBRADIÇA/BISAGRA/HINGE D=35mm C=8	04043	02
PU	 PARAFUSO UNIÃO/UNIÓN DETORNILLO /SCREW UNION	01495	02	S5	 SUPORTE AÉREO/APOYO AÉREO/AIR SUPPORT	03828	02
P32	 PARAFUSO/TORNILLO/SCREW 4X14	12412	12	PI	 PISTÃO GÁS / PISTÓN DE GAS /GAS PISTON	12648 40N	02
P9	 PARAFUSO/TORNILLO/SCREW 6X50	03827	02	AD	ADESIVO/ADHESIVO/ADHESIVE 	15mm	04
				BT	 BATENTE/BATIENTE DE SILICONA/SILICONE STOP 8MM	02921	02
				PX	PUXADOR/PEGADOR /HANDLE SEVILHA NEW GOLD 192 MM 	13106	01

Medida em mm

