

8025

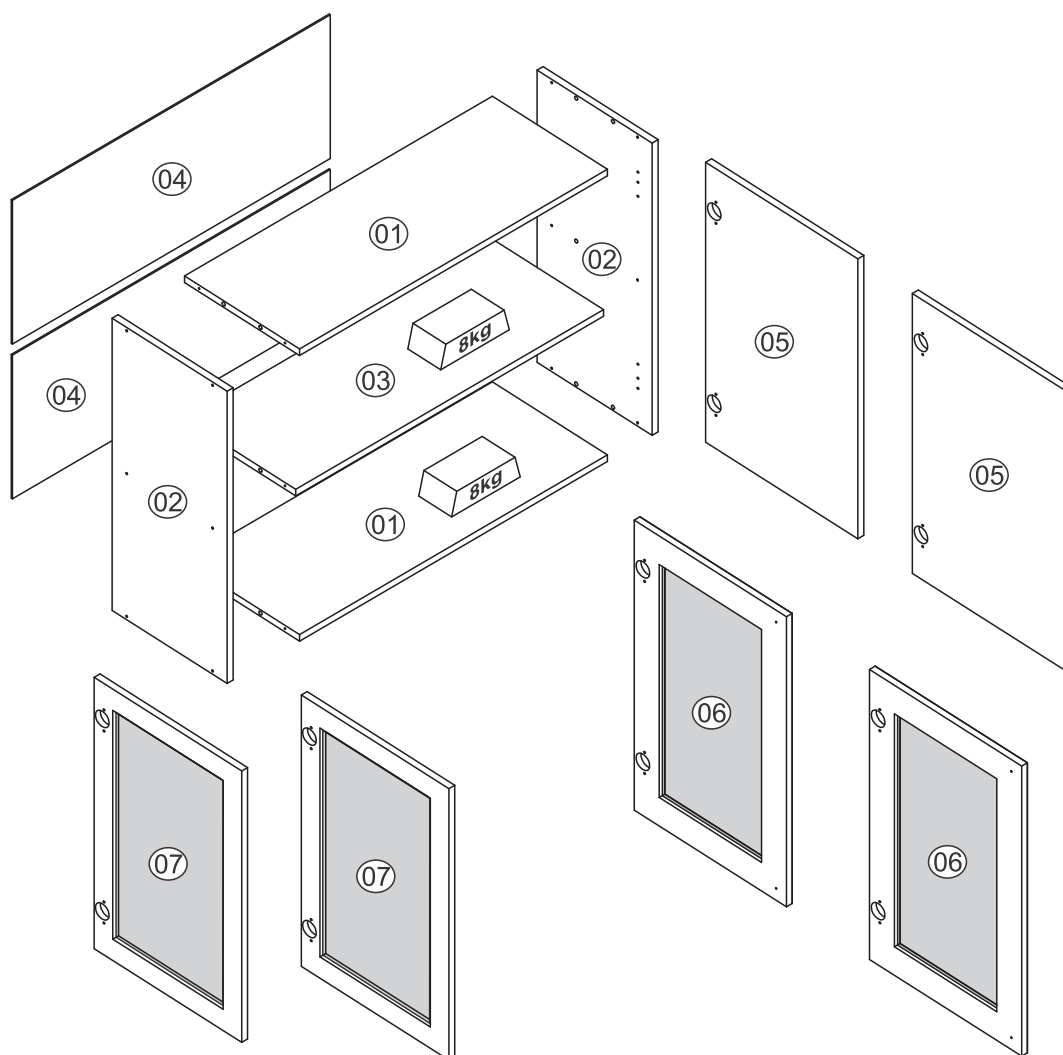









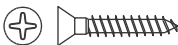
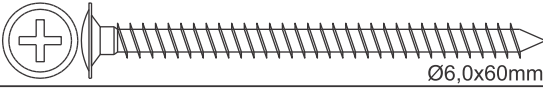

Opcional puxador perfil
Opcional tirador perfil
Optional profile handle

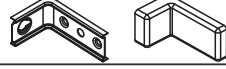
LISTA DE PEÇAS/RELACIÓN PIEZAS/PART LIST

Nº	Código Code	Descrição/Descripción/Description	Dimensão (mm) Dimensiones (mm) Measures (mm)	Qtde. Cantidad Quantity
01	802501	Base/Base/Base	770 x 300 x 15	02
02	802502	Lateral/Side/Lateral	665 x 300 x 15	02
03	802503	Prateleira/Repisa/Shelf	770 x 290 x 15	01
04	800504	Costa/Revés/Back	795 x 327 x 03	02
05	800008	Porta/Puerta/Door (Ref. 8025)	637 x 397 x 15	02
06	Q01319	Porta/Puerta/Door (Ref. 8225)	660 x 397 x 15	02
07	Q01317	Porta/Puerta/Door (Ref. 8025)	637 x 397 x 15	02

FERRAGENS/HERRAJES/HARDWARE

A		Ø4,0x40mm	12
B		Cavilha/Tarugo/Dowel Ø8x30mm	12
C		Ø3,5x14mm	40
D		Ø3,0x25mm	02
E		Ø6,0x60mm	04
F		Prego/Clavo/Nail 10x10	28
G		Bucha/Cojinete/Bush 8mm	04
H			04
I		Garra metálica/Pieza fijación revés/ Back claw 13x13	05
J		Sache cola/Pegamento/Glue	01
K		Dobradiça/Bisagra/Hinge 35mm	04
L		Tapa furo/Tapa agujero/Hole sticker 12mm	12
M		Puxador perfil/Tirador/Handle 397mm Ref. 8025	02
N		Puxador/Tirador/Handle Ref. 8225	02

FERRAMENTAS NECESSÁRIAS

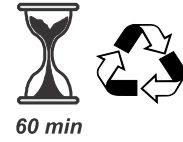
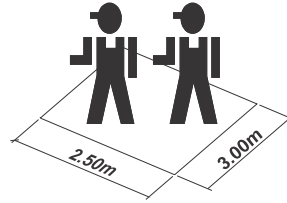
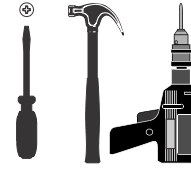

1

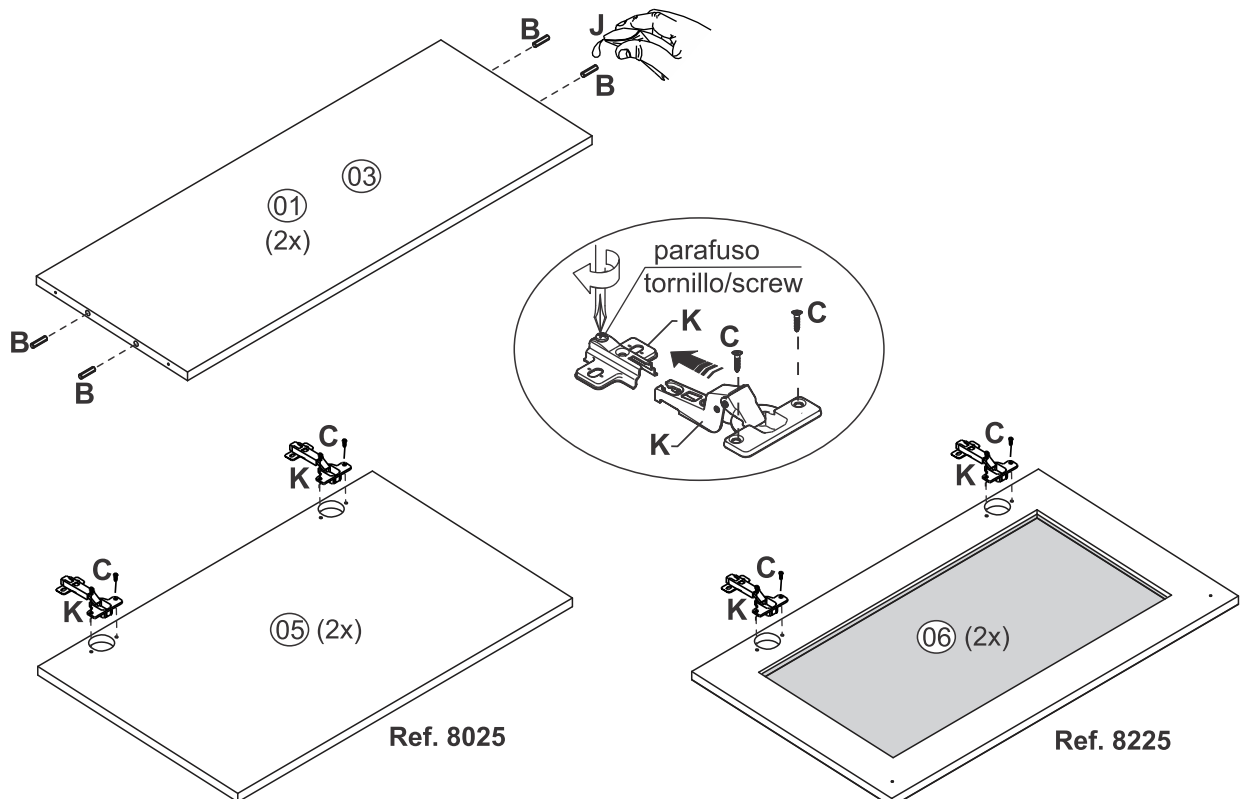

2

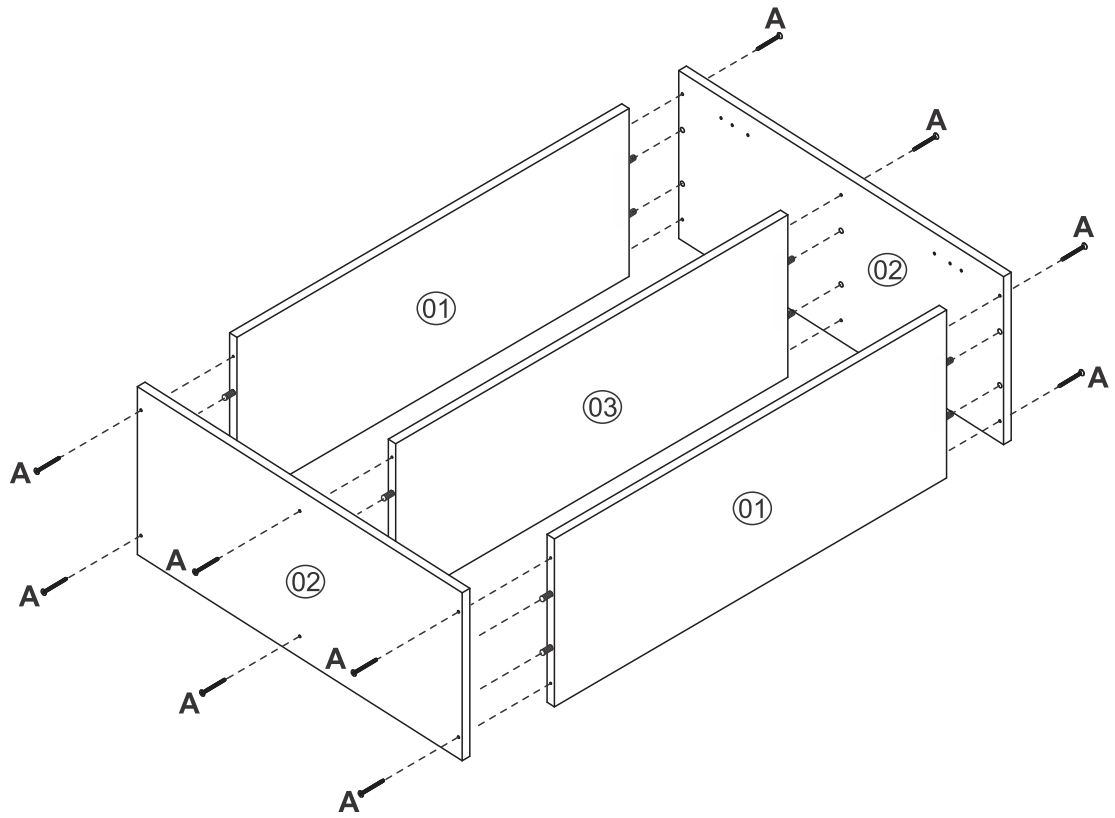

3

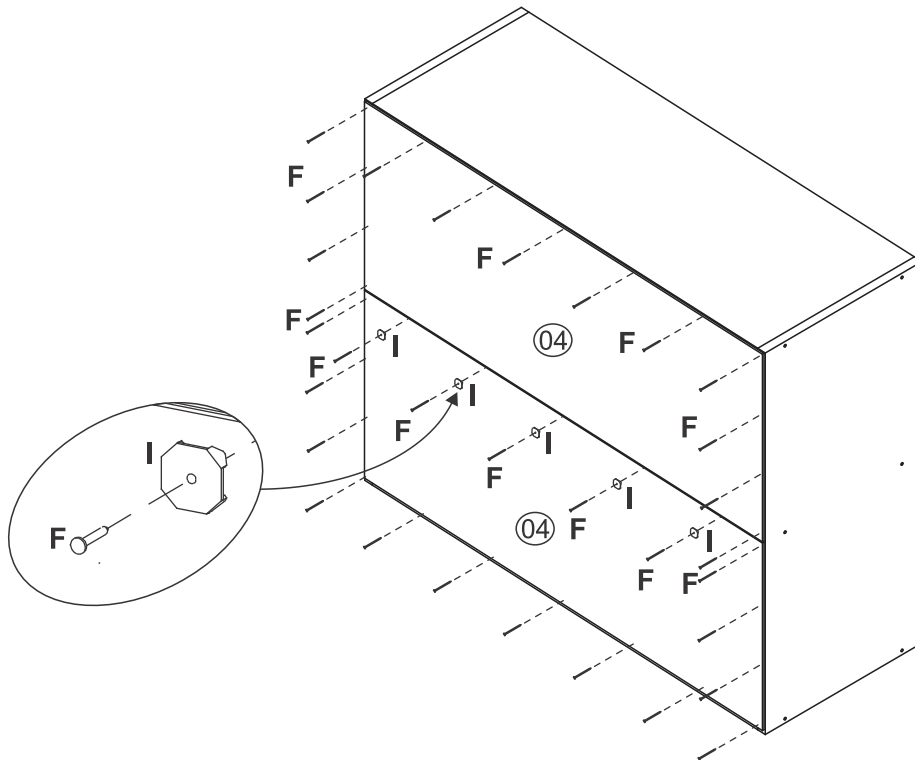

4

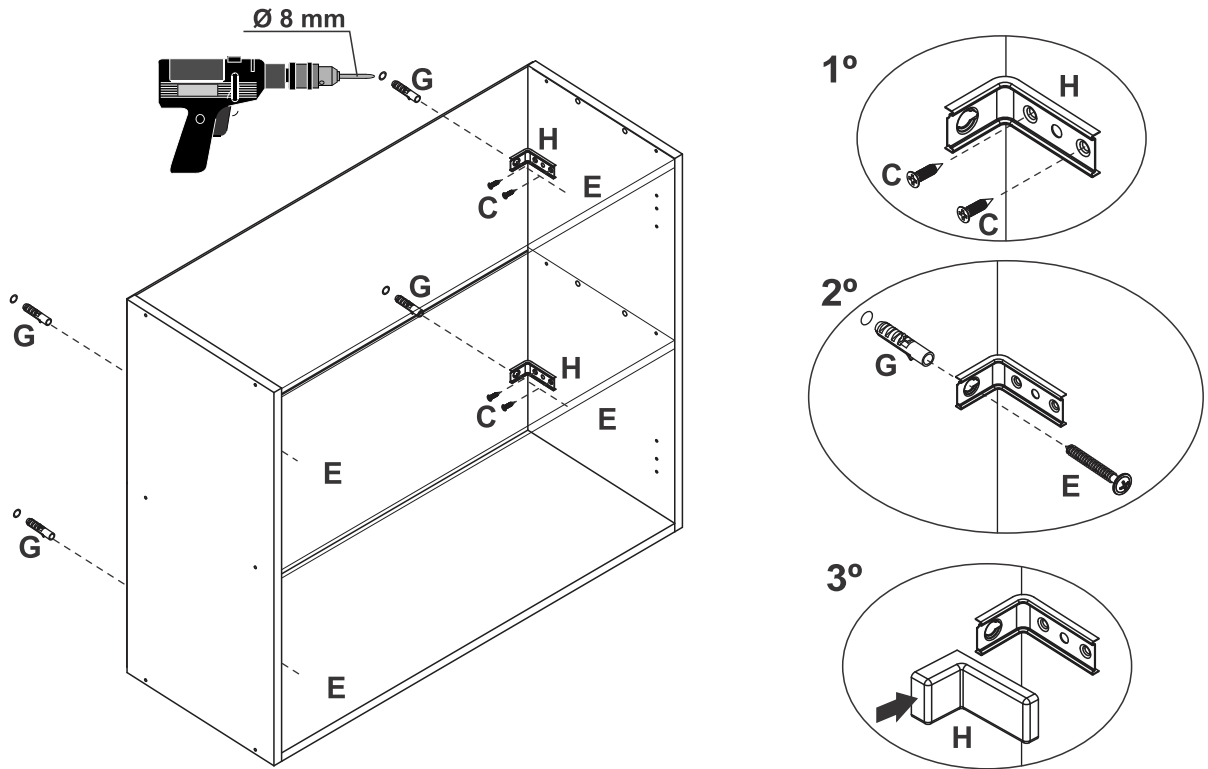

5

