

**HENN**Ind. e Com. de Móveis Henn  
Mondai - SC - Brasil

☎ +55 49 3674.3500

📧 @moveishenn  
www.henn.com.br**INSTRUÇÕES DE  
MONTAGEM**INSTRUCCIONES DE MONTAJE  
ASSEMBLY INSTRUCTIONS**Aéreo 01 Porta Basculante 800mm Requite | Aéreo 01  
Puerta Abatible 800mm Requite |  
Aerial 01 Tipper Door 800mm Requite**

C633-128 Nature

C633-217 Nature/Areia HP

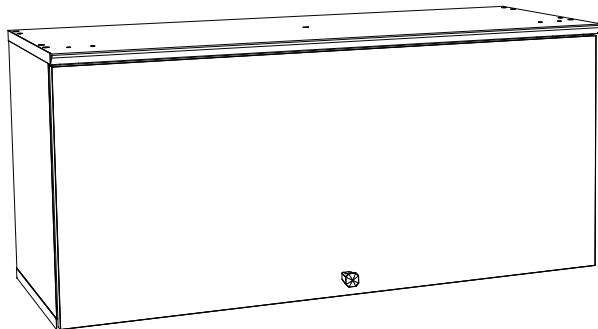
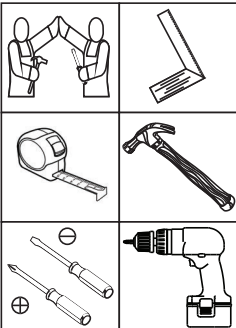
**Requisitos para montagem  
Requisitos para la montaje  
Assembly Requirements**

Imagens meramente ilustrativas,  
não acompanha o produto.  
Imágenes ilustrativas, no incluidas  
con el producto.  
Illustrative images, not included  
with the product.

**AVISO**

Para limpeza de seu móvel, use uma flanela seca ou umedecida, e não utilize produtos químicos que possam danificar seu produto.

**SISTEMA DE MONTAGEM**

O sistema de montagem dos produtos, funciona de acordo com a ordem crescente dos números indicados no desenho. Ex: 01, 02, 03, 04... até a conclusão da montagem.

**ASSISTÊNCIA TÉCNICA**

Para solicitação de Assistência Técnica você consumidor deverá entrar em contato com o Lojista o qual você realizou a compra deste produto e solicitar a assistência técnica das peças avariadas. A garantia abrange todas as peças, partes e componentes que eventualmente venham apresentar defeito de fabricação no prazo de 03 (três) meses, contando a partir da entrega do produto ao consumidor, mediante nota fiscal de compra. Se houver qualquer alteração na estrutura do produto ou ocorrer defeito por negligência do montador/consumidor em relação a instrução de montagem e manuseio, não será fornecido assistência técnica gratuita.

**ADVERTENCIA**

Para limpeza de su móvil, use una franela seca o húmeda, y no utilice productos químicos que puedan dañar su producto.

**SISTEMA DE MONTAJE**

El sistema de montaje de los productos funciona de acuerdo con el orden creciente de los números indicados en el dibujo. Ej.: 01, 02, 03, 04... hasta la conclusión del montaje.

**ASISTENCIA TÉCNICA**

Para solicitar Asistencia Técnica, el consumidor debe comunicarse con el Comercio que usted realizó la compra de este producto y solicita asistencia técnica para las partes dañadas. La garantía cubre todas las partes, piezas y componentes que eventualmente puedan presentar defecto de fabricación en el plazo de 03 (tres) meses, contados a partir de la entrega del producto al consumidor, mediante factura de compra. Si se produce algún cambio en la estructura del producto o se produce un defecto por negligencia del montador/consumidor en relación con las instrucciones de montaje y manipulación, no se prestará asistencia técnica gratuita.

**NOTICE**

To clean your furniture, use a dry or wet cloth, and do not use chemicals that may damage your product.

**ASSEMBLY SYSTEM**

The products' assembly system works according to the increasing order of the indicated numbers. For example: 01, 02, 03, 04 ... to the end of the assembly.

**TECHNICAL ASSISTANCE**

To request Technical Assistance, the consumer must contact the retailer from whom you purchased this product and request technical assistance for the damaged parts. The warranty covers all parts, parts and components that may eventually present a manufacturing defect within a period of 03 (three) months, counting from the delivery of the product to the consumer, by means of a purchase invoice. If there is any change in the structure of the product or defect occurs due to negligence of the assembler/consumer in relation to the assembly and handling instruction, free technical assistance will not be provided.

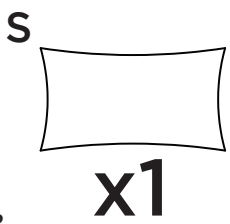
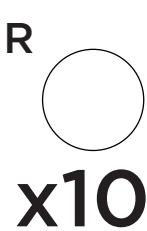
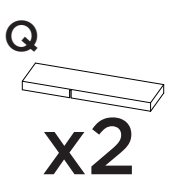
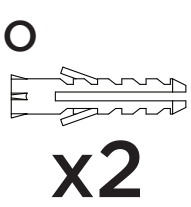
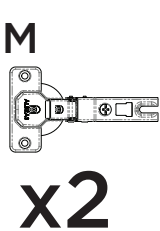
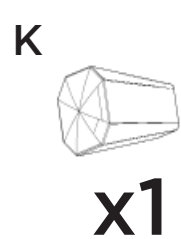
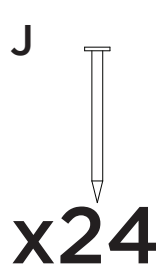
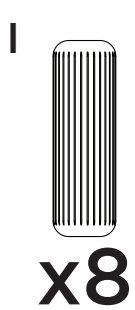
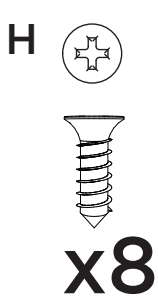
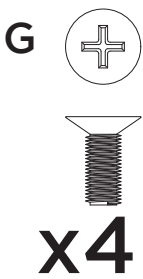
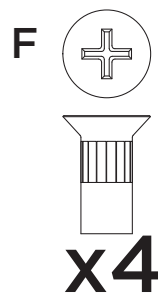
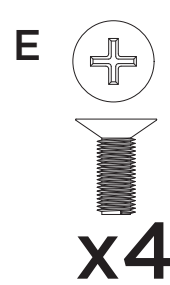
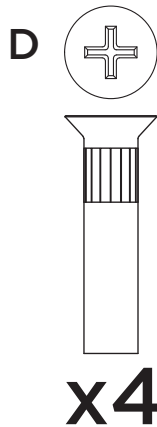
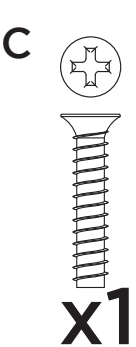
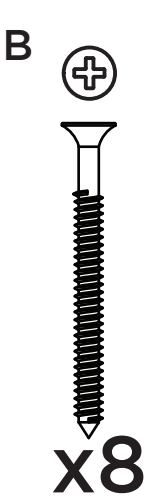
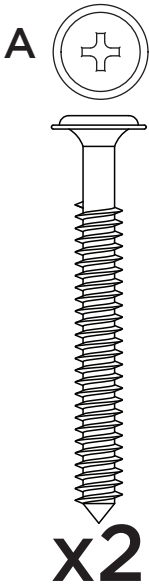

Parafusos em escala  
Tornillos escalados  
Scaled screws **1:1**

Os parafusos (D/E) devem ser usados somente quando este módulo for acoplado a outro módulo componível Henn.

Los tornillos (D/E) se debe utilizar sólo cuando el módulo está conectado a otro módulo componible Henn.

Screws (D/E) are to be used only when this module is mated to another Henn buildable module.

# LISTA DE PEÇAS | LISTA DE PIEZAS | LIST OF PIECES

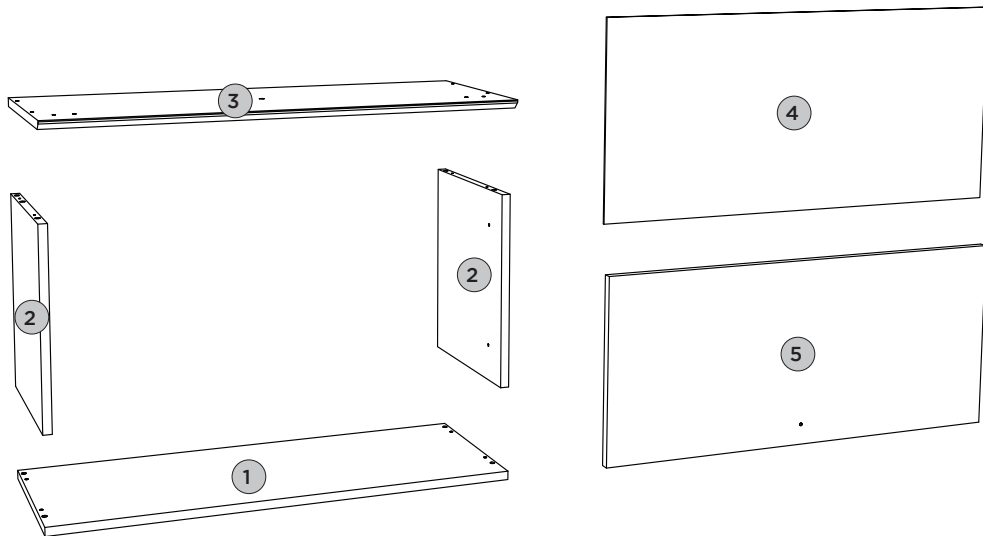





Item	Caixa Caja Box	Qtd Ctd Qty	Descrição Descripción Description	Dimensões (mm)   Dimensiones (mm)		
				Comprimento Largo Length	Largura Ancho Width	Espessura Grosor Thickness
1	1/1	01	BASE   BASE   BASE	800	295	15
2	1/1	02	LATERAL DIREITA ESQUERDA   LATERAL DERECHA IZQUIERDA   RIGHT LEFT SIDE	337	295	15
3	1/1	01	TAMPO   TAPA   TOP	800	322	15
4	1/1	01	FUNDO   FONDO   BACKGROUND	793	361	3
5	1/1	01	PORTA BASCULANTE   PUERTA BASCULANTE   BASCULATING DOOR	796	345	15

**PASSO 1****PEÇAS REQUERIDAS**

2	LATERAL DIREITA ESQUERDA	x2
3	TAMPO	x1

**ACESSÓRIOS REQUERIDOS**

F		04
G		04
I		08
L		02
S		

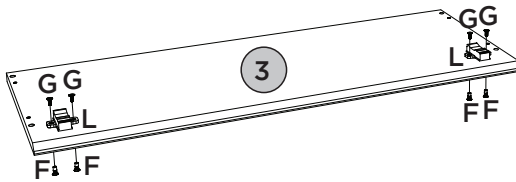
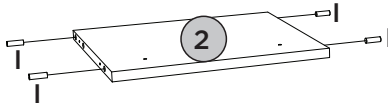
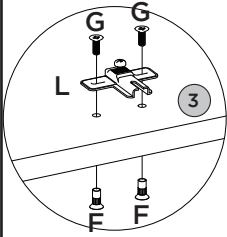
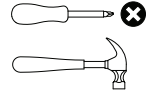
**FERRAMENTAS NECESSÁRIAS**

Utilizar o sachê de cola (S) em todas as cavilhas (I) do produto.



Con el pegamento sobre (S) en todos los pernos (I) producto.

Use the glue sachet (S) on all the pegs (I) of the product.

**PASSO 2****PEÇAS REQUERIDAS**

1	BASE	x1
2	LATERAL DIREITA ESQUERDA	x2
3	TAMPO	x1

**ACESSÓRIOS REQUERIDOS**

B		08
S		

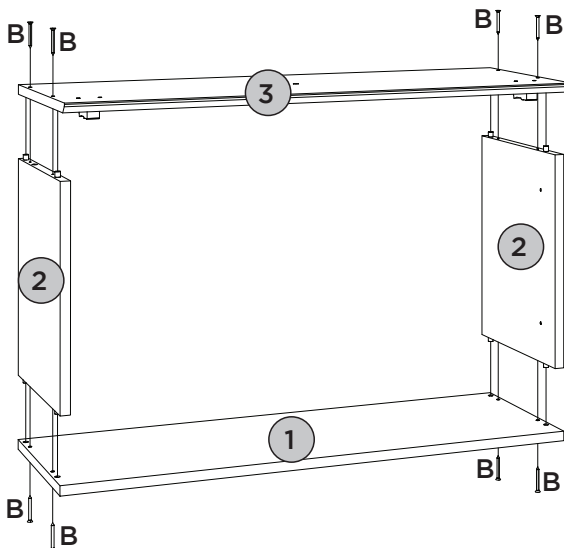
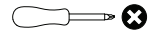
**FERRAMENTAS NECESSÁRIAS**

# PASSO 3

ITM/C633-

## PEÇAS REQUERIDAS

4	FUNDO	x1
---	-------	----

## ACESSÓRIOS REQUERIDOS

J		24
---	---	----

## FERRAMENTAS NECESSÁRIAS

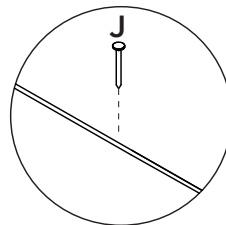
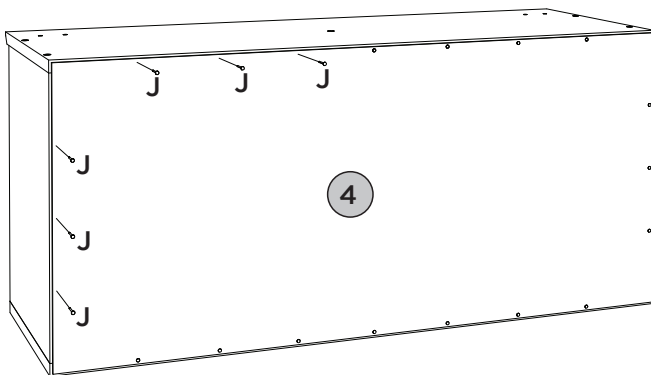
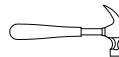

Fixar os pregos a uma distância de 100mm de um para outro.

Fijar las uñas a un distancia de 100mm uno a otro.







Fix the nails at a distance of 100mm from one to the other

# PASSO 4

## PEÇAS REQUERIDAS

5	PORTA BASCULANTE	x1
---	------------------	----

## ACESSÓRIOS REQUERIDOS

C	 	01
H	 	04
K		01
M		02

## FERRAMENTAS NECESSÁRIAS

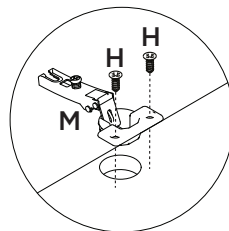
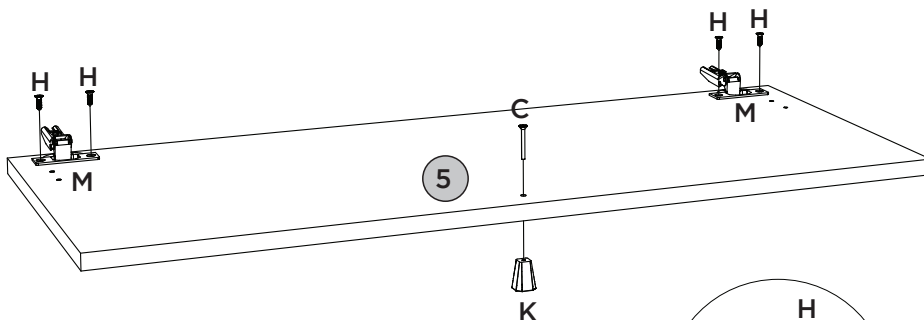
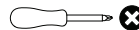

**PEÇAS REQUERIDAS**

5	PORTA BASCULANTE	x1
---	------------------	----

**ACESSÓRIOS REQUERIDOS**

N		01
---	--	----

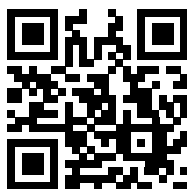
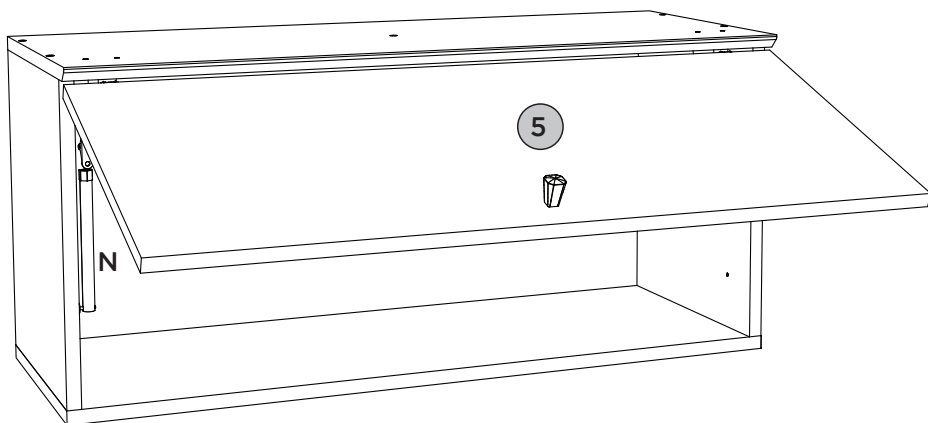
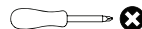
**FERRAMENTAS NECESSÁRIAS**

Vídeo: Dicas para instalar o Kit Pistão à Gás

Vídeo: Consejos para instalar el kit de pistón de gas

Vídeo: Tips for installing the Gas Piston Kit

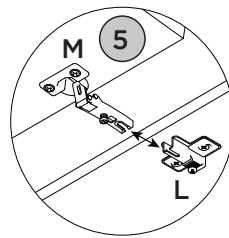
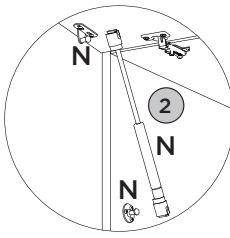
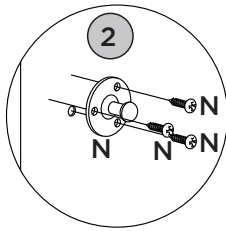
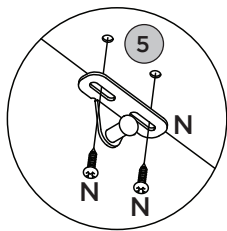

ACESSÓRIOS REQUERIDOS

A		02
H		04
O		02
P		02
Q		02
R		10

FERRAMENTAS NECESSÁRIAS



OU

Para parede: Ajustar no modo perfuração  
Para peça (O2): Usar torque 5

Pesos máximos recomendados com carga distribuída  
Peso máximo recomendado con la carga distribuida  
Recommended maximum weight with distributed load.

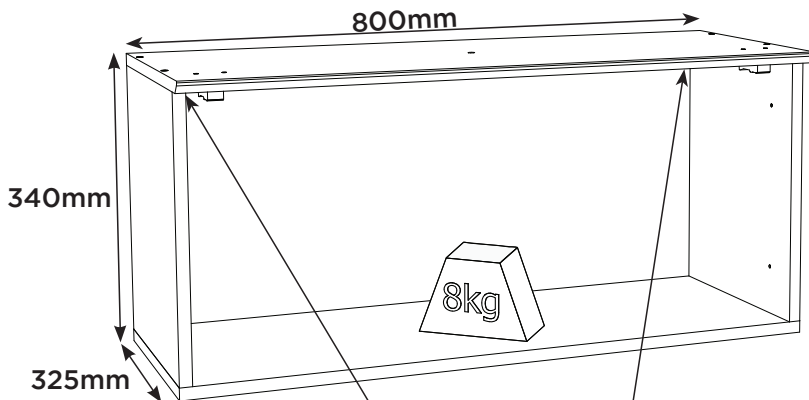

RECOMENDAÇÃO

Para fixar o móvel na parede usar o suporte de fixação (P), o parafuso 4,0x14mm CHT (H), a Bucha 8mm (O) e o parafuso 5,0x50mm FLA (A).

RECOMENDACIÓN

Para conectar el móvil a la pared con el soporte (P), tornillo 4,0 x14mm CHT (H), el casquillo de 8 mm (O) y el 5,0 x50mm tornillo FLA (A).

RECOMMENDATION

To fix the furniture to the wall use the fixing bracket (P), the 4,0x14mm CHT (H) screw, the 8mm bushing (O) and the 5,0x50mm FLA screw (A).

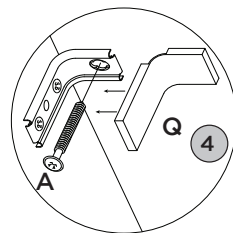
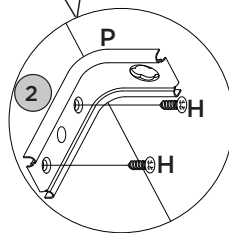
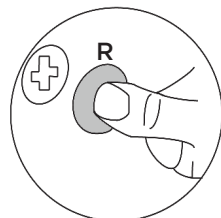

**Produto Concluído**  
**Producto terminado**  
**Finished Product**

