

HENNInd. e Com. de Móveis Henn
Mondai - SC - Brasil

☎ +55 49 3674.3500

📧 @moveishenn
www.henn.com.br**INSTRUÇÕES DE
MONTAGEM**INSTRUCCIONES DE MONTAJE
ASSEMBLY INSTRUCTIONS**Aéreo Canto Reto 01 Porta Requite |
Aire Esquina Recto 01 Puerta Requite |
Aerial Corner Challenge 01 Door Requite**

C634-128 Nature

C634-217 Nature/Areia HP

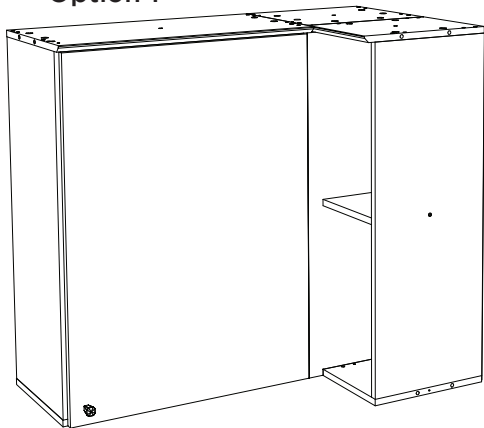
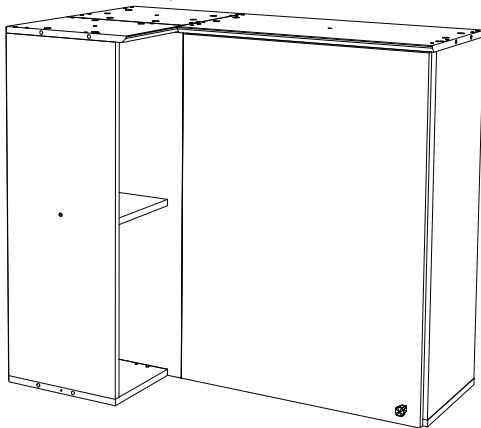
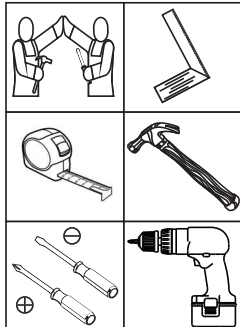
**Opção 1
Opción 1
Option 1****Opção 2
Opción 2
Option 2****Requisitos para montagem
Requisitos para la montaje
Assembly Requirements****Imagens meramente ilustrativas,
não acompanha o produto.
Imágenes ilustrativas, no incluidas
con el producto.
Illustrative images, not included
with the product.****AVISO**

Para limpeza de seu móvel, use uma flanela seca ou umedecida, e não utilize produtos químicos que possam danificar seu produto.

SISTEMA DE MONTAGEM

O sistema de montagem dos produtos, funciona de acordo com a ordem crescente dos números indicados no desenho. Ex: 01, 02, 03, 04... até a conclusão da montagem.

ASSISTÊNCIA TÉCNICA

Para solicitação de Assistência Técnica você consumidor deverá entrar em contato com o Lojista o qual você realizou a compra deste produto e solicitar a assistência técnica das peças avariadas. A garantia abrange todas as peças, partes e componentes que eventualmente venham apresentar defeito de fabricação no prazo de 03 (três) meses, contando a partir da entrega do produto ao consumidor, mediante nota fiscal de compra. Se houver qualquer alteração na estrutura do produto ou ocorrer defeito por negligência do montador/consumidor em relação a instrução de montagem e manuseio, não será fornecido assistência técnica gratuita.

ADVERTENCIA

Para limpieza de su móvil, use una flanela seca o húmeda, y no utilice productos químicos que puedan dañar su producto.

SISTEMA DE MONTAJE

El sistema de montaje de los productos funciona de acuerdo con el orden creciente de los números indicados en el dibujo. Ej.: 01, 02, 03, 04... hasta la conclusión del montaje.

ASISTENCIA TÉCNICA

Para solicitar Asistencia Técnica, el consumidor debe comunicarse con el Comercio que usted realizó la compra de este producto y solicita asistencia técnica para las partes dañadas. La garantía cubre todas las partes, piezas y componentes que eventualmente puedan presentar defecto de fabricación en el plazo de 03 (tres) meses, contados a partir de la entrega del producto al consumidor, mediante factura de compra. Si se produce algún cambio en la estructura del producto o se produce un defecto por negligencia del montador/consumidor en relación con las instrucciones de montaje y manipulación, no se prestará asistencia técnica gratuita.

NOTICE

To clean your furniture, use a dry or wet cloth, and do not use chemicals that may damage your product.

ASSEMBLY SYSTEM

The products' assembly system works according to the increasing order of the indicated numbers. For example: 01, 02, 03, 04 ... to the end of the assembly.

TECHNICAL ASSISTANCE

To request Technical Assistance, the consumer must contact the retailer from whom you purchased this product and request technical assistance for the damaged parts. The warranty covers all parts, parts and components that may eventually present a manufacturing defect within a period of 03 (three) months, counting from the delivery of the product to the consumer, by means of a purchase invoice. If there is any change in the structure of the product or defect occurs due to negligence of the assembler/consumer in relation to the assembly and handling instruction, free technical assistance will not be provided.

ACESSÓRIOS | ACCESORIOS | ACCESSORIES

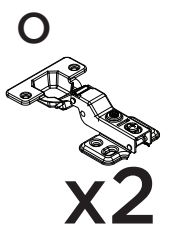
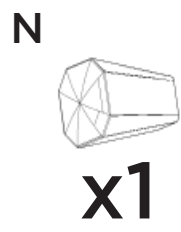
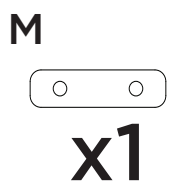
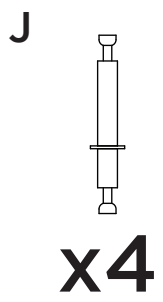
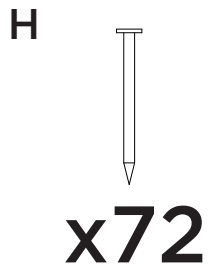
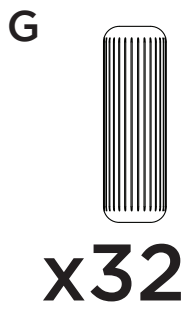
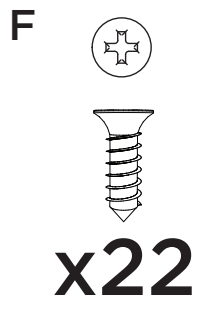
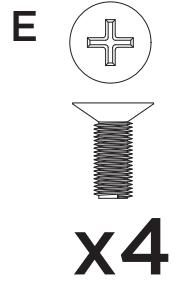
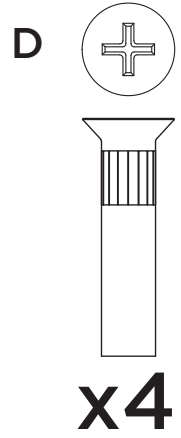
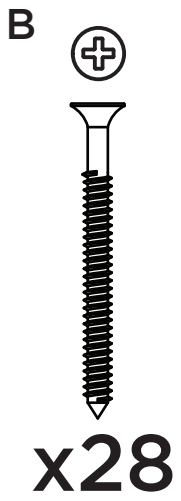
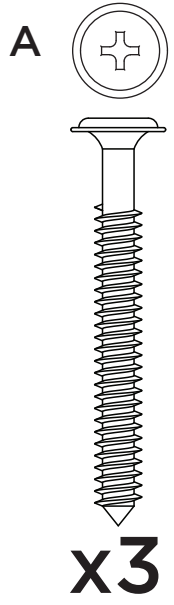

Parafusos em escala
Tornillos escalados
Scaled screws **1:1**

ACESSÓRIOS | ACCESORIOS | ACCESSORIES

P

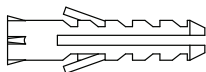

x3

Q

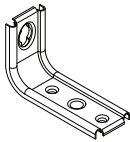

x3

R

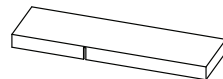

x3

S

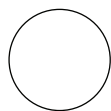

x30

T

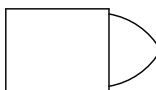

x2

U

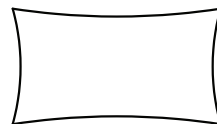

x2



Os parafusos (D/E) devem ser usados somente quando este módulo for acoplado a outro módulo componível Henn.



Los tornillos (D/E) se debe utilizar sólo cuando el módulo está conectado a otro módulo componible Henn.



Screws (D/E) are to be used only when this module is mated to another Henn buildable module.

LISTA DE PEÇAS | LISTA DE PIEZAS | LIST OF PIECES

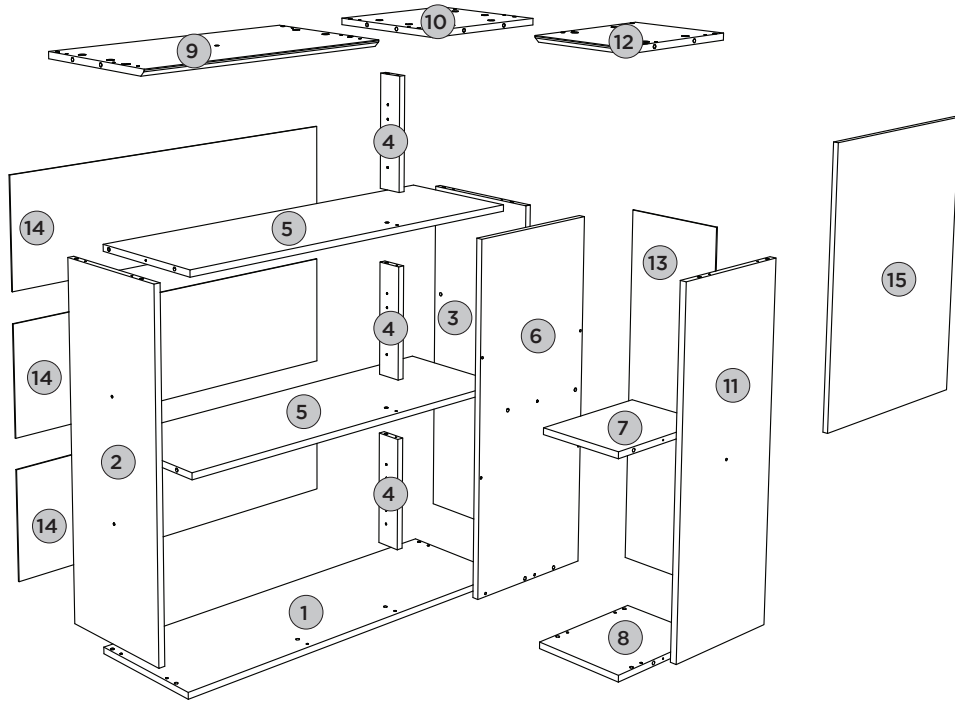

Item	Caixa Caja Box	Qty Ctd Qty	Descrição Descripción Description	Dimensões (mm) Dimensions (mm) Dimensions (mm)		
				Comprimento Largo Length	Largura Ancho Width	Espessura Grosor Thickness
1	1/1	01	BASE BASE BASE	940	295	15
2	1/1	01	LATERAL ESQUERDA LATERAL IZQUIERDA LEFT SIDE	800	295	15
3	1/1	01	FUNDO 15MM FONDO 15MM 15MM BOTTOM	800	295	15
4	1/1	03	PILASTRA DA PORTA PUERTA PILASTRA DOOR PILASTER	256	60	15
5	1/1	02	PRATELEIRA ESTANTE SHELF	909	295	15
6	1/1	01	FRENTE FIXA FRENTE FIJA FIXED FRONT	815	333	15
7	1/1	01	PRATELEIRA NICHU ESTANTERIA DE NICHU NICHE SHELF	293	208	15
8	1/1	01	BASE NICHU NICHU BASE BASE NICHE	295	223	15
9	1/1	01	TAMPO MAIOR TAPA MAYOR TOP SURFACE	618	322	15
10	1/1	01	TAMPO MENOR TAPA MAYOR TOP SURFACE	322	295	15
11	1/1	01	LATERAL DIREITA NICHU NICHU LADO DERECHO RIGHT SIDE NICHE	800	295	15
12	1/1	01	TAMPO NICHU TAPA NICHU NICHE TOP	322	238	15
13	1/1	01	FUNDO MENOR FONDO MENOR MINOR FUND	824	235	3
14	1/1	03	FUNDO FONDO BOTTOM	933	273	3
15	1/1	01	PORTA PUERTA DOOR	813	597	15



PASSO 1

ITM/C634-

PEÇAS REQUERIDAS

2	LATERAL ESQUERDA	x1
3	FUNDO 15MM	x1
4	PILASTRA DA PORTA	x3

ACESSÓRIOS REQUERIDOS

G		14
U		

FERRAMENTAS NECESSÁRIAS

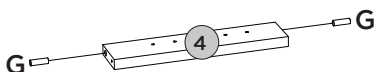
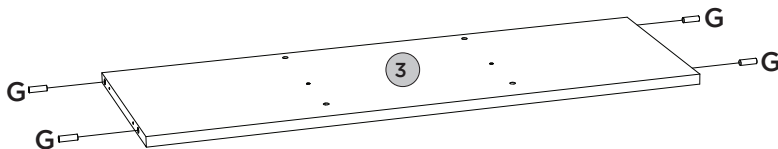
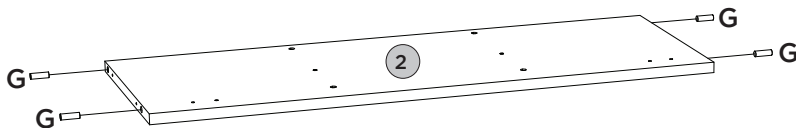
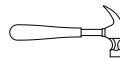

Utilizar o sachê de cola (U) em todas as cavilhas (G) do produto.

Con el pegamento sobre (U) en todos los pernos (G) producto.

Use the glue sachet (U) on all the pegs (G) of the product.



PASSO 2

ITM/C634-

PEÇAS REQUERIDAS

5	PRATELEIRA	x2
7	PRATELEIRA NICHU	x1
11	LATERAL DIREITA NICHU	x1

ACESSÓRIOS REQUERIDOS

G		16
U		

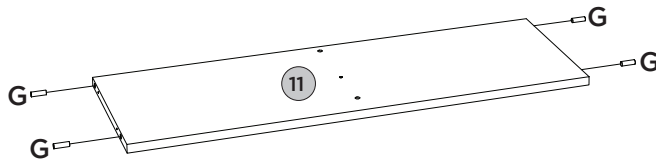
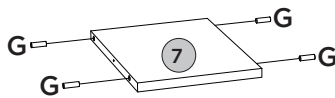
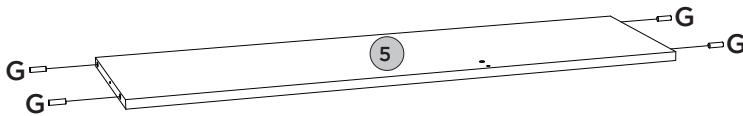

FERRAMENTAS NECESSÁRIAS



PEÇAS REQUERIDAS

1	BASE	x1
2	LATERAL ESQUERDA	x1
3	FUNDO 15MM	x1
4	PILASTRA DA PORTA	x3
5	PRATELEIRA	x2

ACESSÓRIOS REQUERIDOS

B		11
U		

FERRAMENTAS NECESSÁRIAS

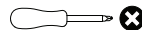

Opção 1 Opción 1 Option 1

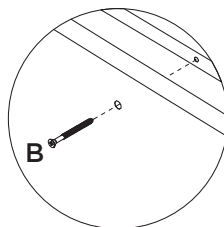
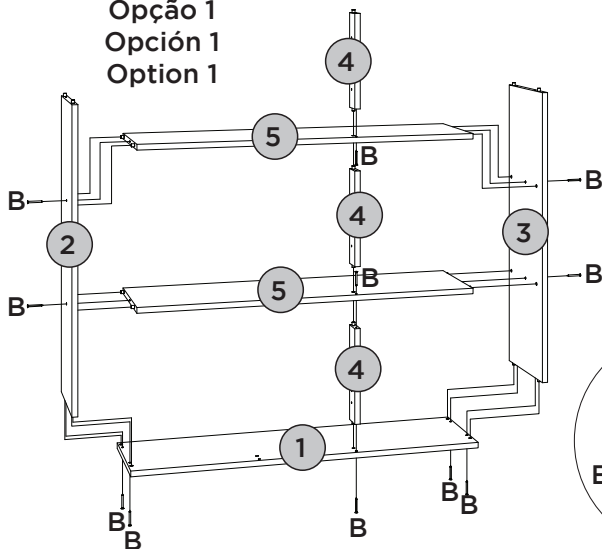

Opção 2 Opción 2 Option 2

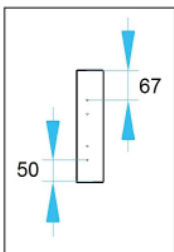
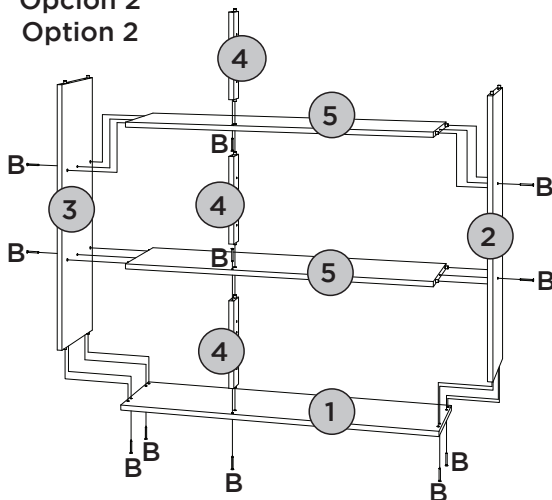

Peça (04) com o lado da pinção de 50mm para baixo.

Parte (04) con el lado del orificio de 50mm hacia abajo.

Part (04) with the side of the pinhole of 50mm down.



PASSO 4

ITM/C634-

PEÇAS REQUERIDAS

6	FRENTE FIXA	x1
7	PRATELEIRA NICHU	x1
8	BASE NICHU	x1

ACESSÓRIOS REQUERIDOS

B		02
G		02
U		

FERRAMENTAS NECESSÁRIAS

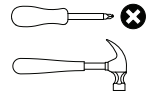

Opção 1 Opción 1 Option 1

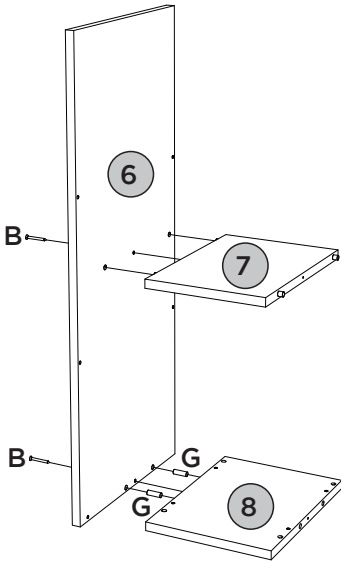

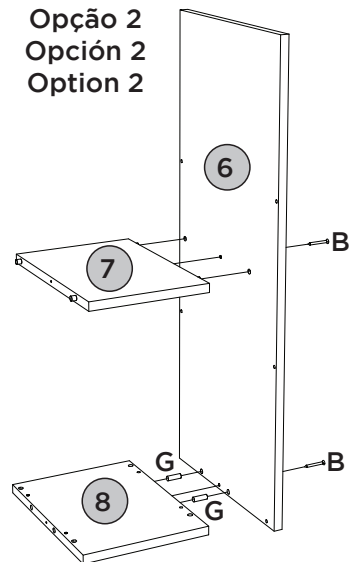

Opção 2 Opción 2 Option 2



PEÇAS REQUERIDAS

9	TAMPO MAIOR	x1
10	TAMPO	x1

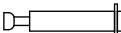
ACESSÓRIOS REQUERIDOS

J		02
K		04

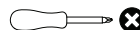
FERRAMENTAS NECESSÁRIAS

Opção 1
Opción 1
Option 1

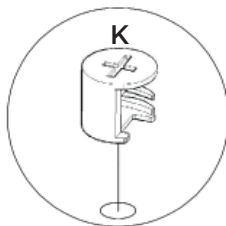
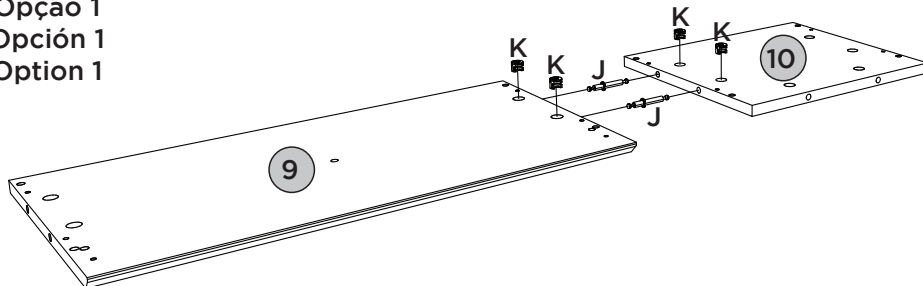



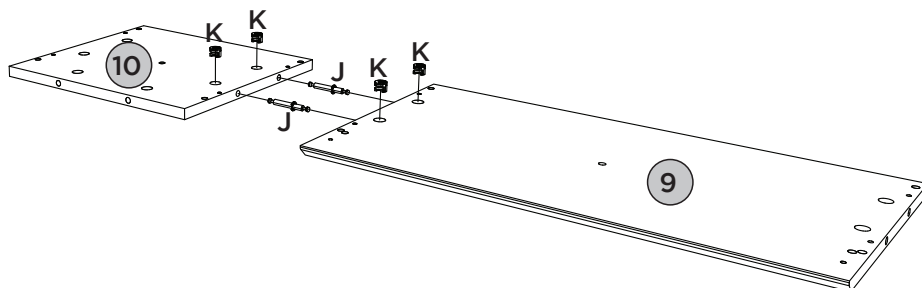



Opção 2
Opción 2
Option 2

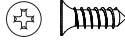

ACESSÓRIOS REQUERIDOS

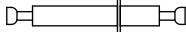
FERRAMENTAS NECESSÁRIAS

B		10	K		02
F		02	L		01
J		02	U		

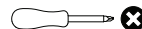

Opção 1

Opcción 1

Option 1

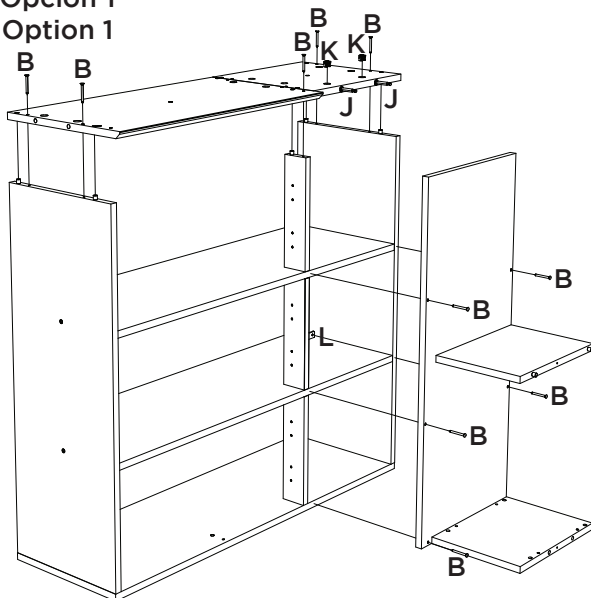

Na opção do Nicho, recomenda-se apertar as ferragens J e K antes de fixar a peça 06.

En la opción de nicho, se recomienda para apretar los accesorios J y K antes de fijar la pieza 06.

In the Niche, it is recommended to tighten the hardware J and K before securing part 06.

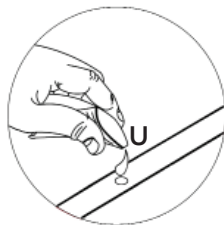
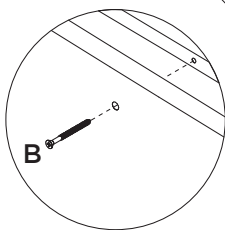
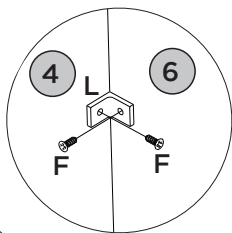

Opção 2
Opcción 2
Option 2

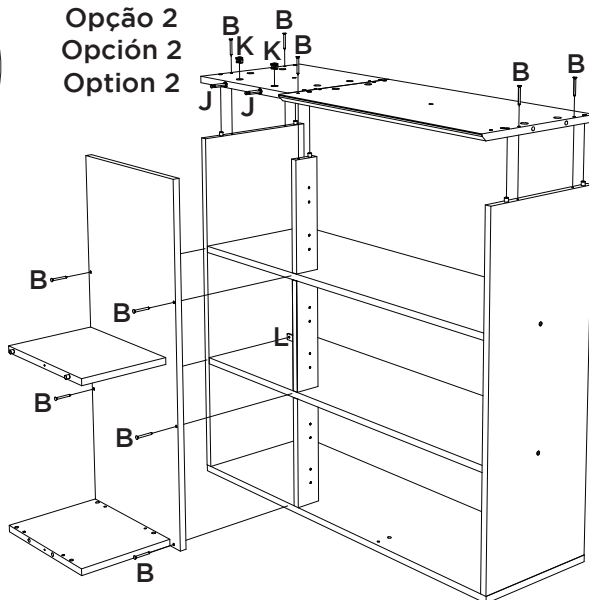



PASSO 7

ITM/C634-

PEÇAS REQUERIDAS

11	LATERAL DIREITA NICHOS	x1
12	TAMPO NICHOS	x1

ACESSÓRIOS REQUERIDOS

B		05
K		02
U		

FERRAMENTAS NECESSÁRIAS

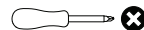

Opção 1
Opción 1
Option 1

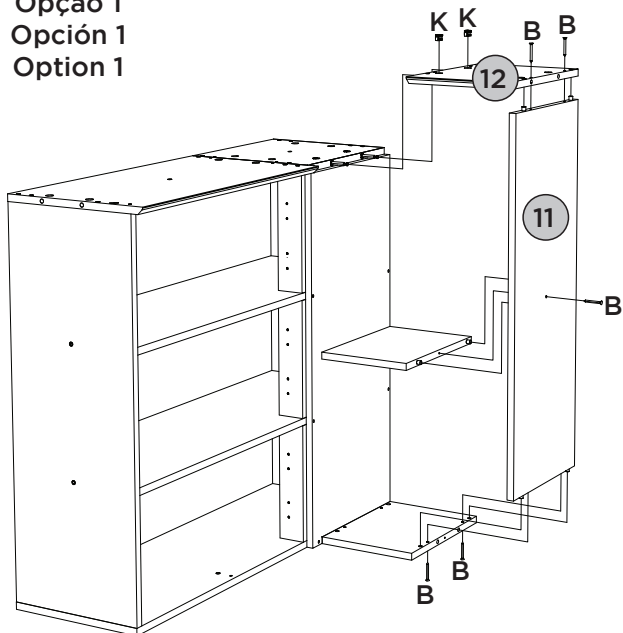

Opção 2
Opción 2
Option 2

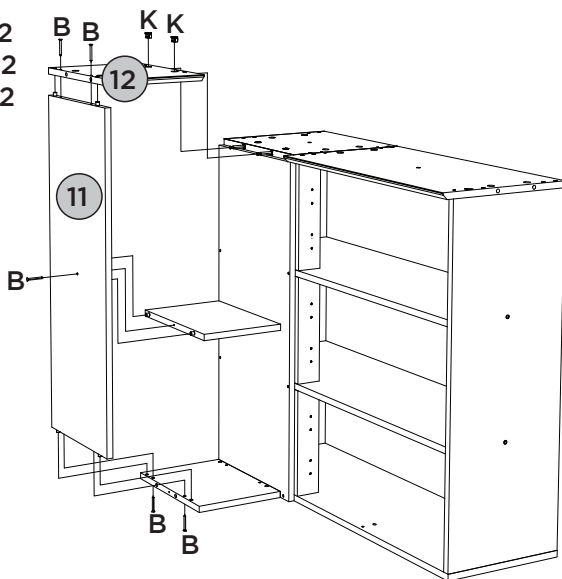





PASSO 8

ITM/C634-

PEÇAS REQUERIDAS

13	FUNDO MENOR	x1
14	FUNDO	x3

ACESSÓRIOS REQUERIDOS

F		02
H		72
I		16
M		01

FERRAMENTAS NECESSÁRIAS

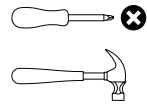

Opção 1
Opción 1
Option 1

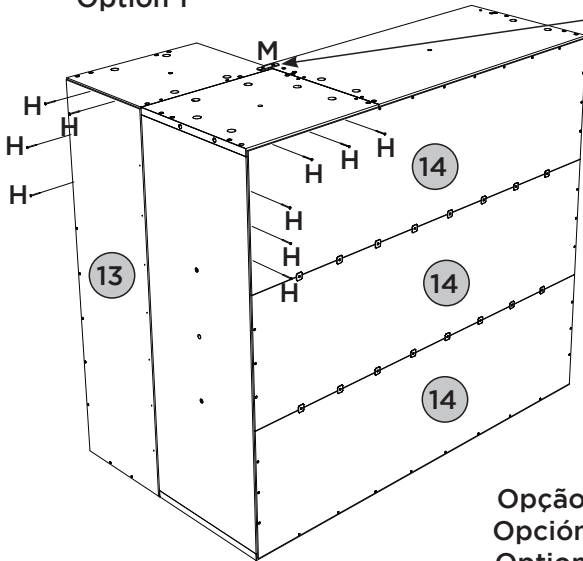

Fixar os pregos a uma distância de 100mm de um para outro.

Fixar las uñas a un distancia de 100mm uno a otro.

Fix the nails at a distance of 100mm from one to the other

Opção 2
Opción 2
Option 2

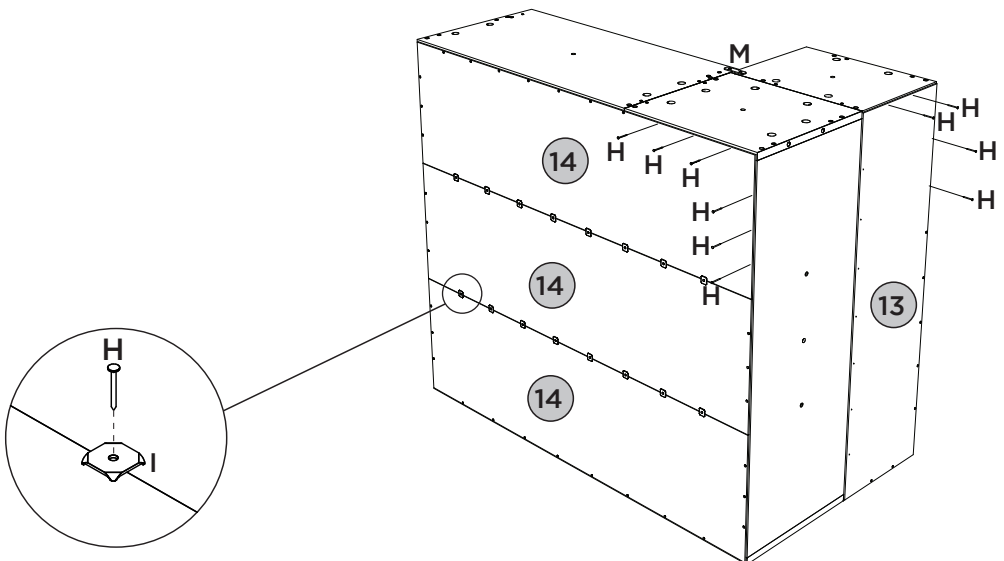



PASSO 9

ITM/C634-

PEÇAS REQUERIDAS

15	PORTA	x1
----	-------	----

ACESSÓRIOS REQUERIDOS

F		04
O		02



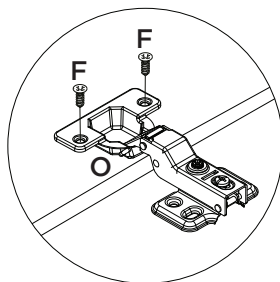
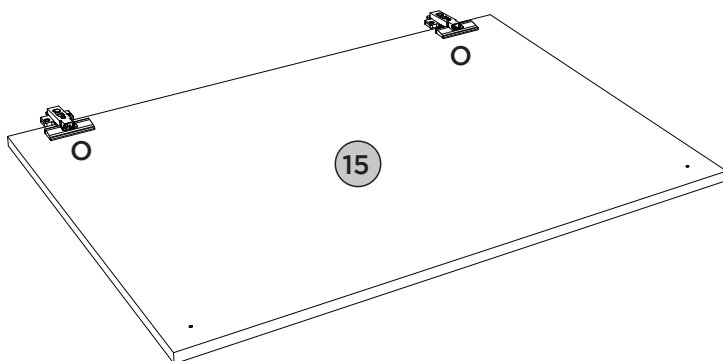
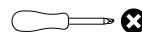

FERRAMENTAS NECESSÁRIAS

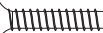

PEÇAS REQUERIDAS

15	PORTA	x1
----	-------	----

ACESSÓRIOS REQUERIDOS

C			01
F			08
N			01

FERRAMENTAS NECESSÁRIAS

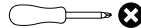

Para porta (15): Defina para o modo de perfuração.

Faça a furação passante para fixar o puxador (N).

Opção 1 Opción 1 Option 1

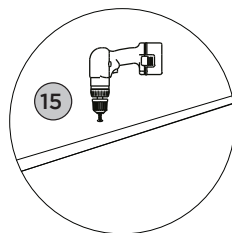
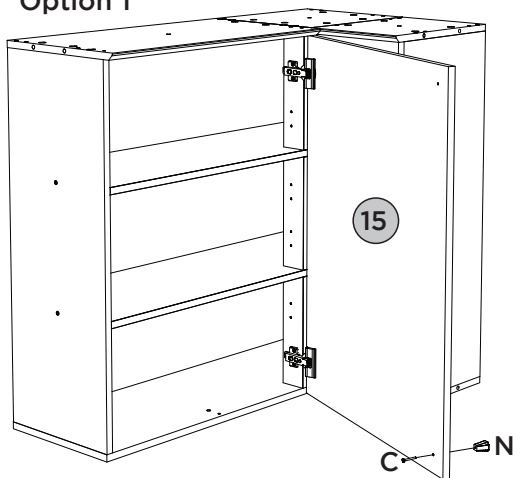

Opção 2 Opción 2 Option 2

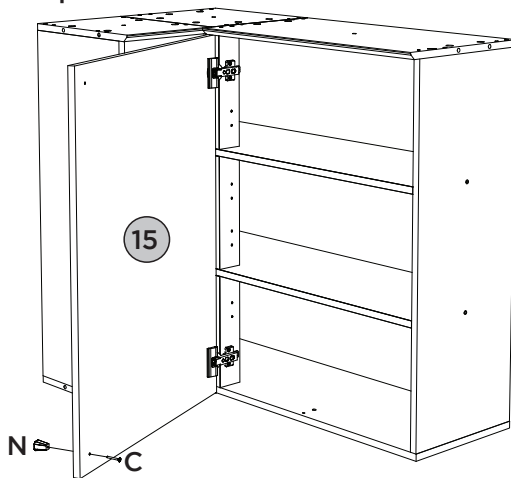
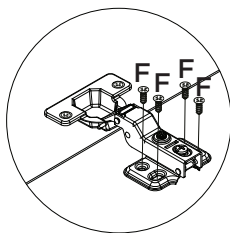

ACESSÓRIOS REQUERIDOS

A		03
F		06
P		03
Q		03
R		03
S		30
T		02

FERRAMENTAS NECESSÁRIAS



OU

Para parede: Ajustar no modo perfuração
Para peças (2, 3 e 9): Usar torque 5

Pesos máximos recomendados com carga distribuída
Peso máximo recomendado con la carga distribuida
Recommended maximum weight with distributed load.

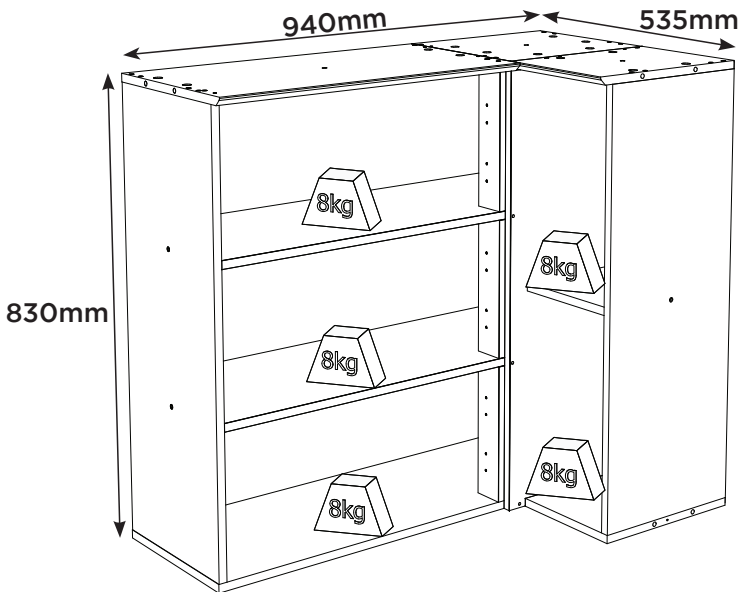

PERFECT CORRECTION
CORRECCIÓN PERFECTA

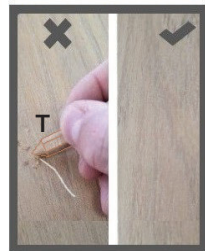

RECOMENDAÇÃO

Para fixar o móvel na parede usar o suporte de fixação (Q), o parafuso 4,0x14mm CHT (F), a Bucha 8mm (P) e o parafuso 5,0x50mm FLA (A).

RECOMENDACIÓN

Para conectar el móvil a la pared con el soporte (Q), tornillo 4,0x14mm CHT (F), el casquillo de 8 mm (P) y el 5,0 x50mm tornillo FLA (A).

RECOMMENDATION

To fix the furniture to the wall use the fixing bracket (Q), the 4,0x14mm CHT (F) screw, the 8mm bushing (P) and the 5.0x50mm FLA screw (A).

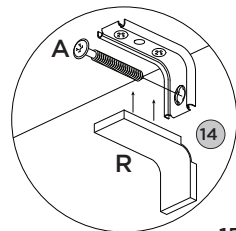
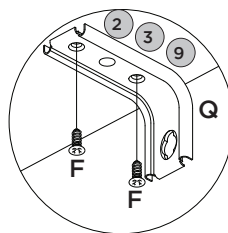
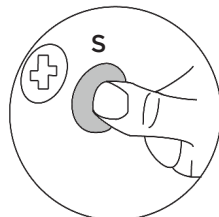

Produto Concluído
Producto terminado
Finished Product

