

HENNInd. e Com. de Móveis Henn
Mondai - SC - Brasil

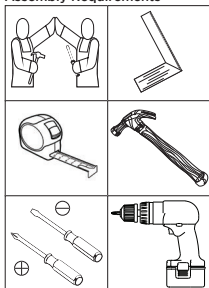

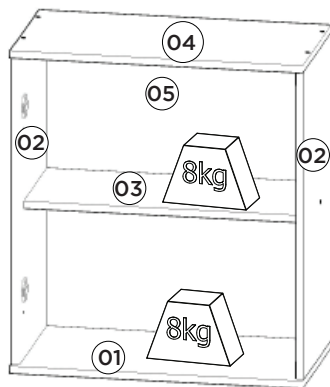

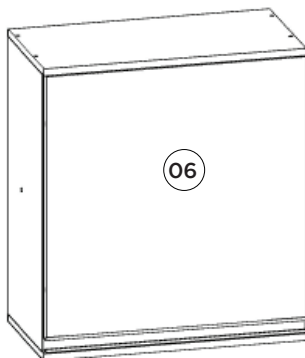



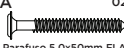
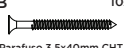
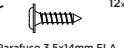
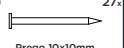

☎ +55 49 3674.3500

 @moveishenn
www.henn.com.br
INSTRUÇÕES DE MONTAGEM**INSTRUCCIONES DE MONTAJE
ASSEMBLY INSTRUCTIONS****Aéreo 01 Porta 600mm Connect | Aéreo 01 Puerta 600mm Connect | Aerial 01 Door 600mm Connect**
Referência/Cor
 c C53-35 Duna/Cristal
 c C53-42 Fendi

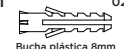
Requisitos para montagem
Requisitos para la montaje
Assembly Requirements

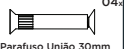
Imagens meramente ilustrativas
Imágenes meramente ilustrativas
Images for illustration only

Peso máximos recomendados com carga distribuída
Peso máximo recomendado con la carga distribuída
Recommended maximum weight with distributed load.
Lista de Peças | Lista de piezas | List of parts

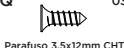
Item	Caixa Caja Box	Qty Ctd Qty	Descrição Descripción Description	Medidas (mm) Dimensiones (mm) Size (measurements) (mm)
01=04	1/1	01	Base tampo Base cubierta Base top	600x310x15
02	1/1	02	Lateral Direita Esquerda Lateral Derecha Izquierda Right Side Left	645x295x15
03	1/1	01	Prateleira Estante Shelf	568x250x15
04=01	1/1	01	Base tampo Base cubierta Base top	400x310x15
05	1/1	01	Fundo Fondo Bottom	592x334x3
06	1/1	01	Porta Puerta Door	612x595x15

Ferragens | Herrajes | Hardware

A  02, J  10, C  12, D  27, E  12, F  02, G  02, H  01.	Parafuso 5,0x50mm FLA. Tornillo 5,0x50mm FLA. Screw 5,0x50mm FLA.	Parafuso 3,5x40mm CHT. Tornillo 3,5x40mm CHT. Screw 3,5x40mm CHT.	Parafuso 3,5x14mm FLA. Tornillo 3,5x14mm FLA. Screw 3,5x14mm FLA.	Prego 10x10mm Clavo 10x10mm Nail 10x10mm	Cavilha 8x25mm Cinta 8x25mm Dowel 8x25mm	Calço metal médio 0mm Calzón de metal medio 0mm Shim metal middle 0mm	Dobradica metal 35mm Colo Baixo Bisagra de metal 35mm Colo Bajo Metal hinge 35mm Colo Low	Puxador MOV 595mm Tirador MOV 595mm MOV 595mm Handle
I  02, J  02, K  02, L  04, M  02, N  01, O  10, P  05.	Bucha plástica 8mm Bucha de plástico 8mm 8mm plastic bushing	Suporte de fixação Soporte de fijación Mounting bracket	Proteção para cantoneira Angulo de protección Protection angle	Parafuso União 30mm Tornillo Unión 30mm Union Screw 30mm	Batente PVC para Porta Parada de PVC para Puerta PVC Door Stop	Sachê de cola Bolsa de pegamento Glue Bag	Adesivo tapa parafuso 10mm Adhesivo tapon de tornillo 10mm Bolt cover adhesive 10mm	Fixador de fundos Fijador de fondos Bottom fixer
Q  03.	Parafuso 3,5x12mm CHT. Tornillo 3,5x12mm CHT. Screw 3,5x12mm CHT.							

O parafuso (L) deve ser usada somente quando este módulo for acoplado a outro módulo componível Henn.

El tornillo (L) se debe utilizar sólo cuando el módulo está conectado a otro módulo componible Henn.

The screw (L) should be used only when this module is attached to another Henn modular module.

RECOMENDAÇÃO

Para fixar o móvel na parede usar o suporte de fixação (J), o parafuso 3,5x14mm FLA (C), a Bucha 8mm (I) e o parafuso 5,0x50mm FLA (A).

RECOMENDACIÓN

Para conectar el móvil a la pared con el soporte (J), tornillo 3,5 x14mm FLA (C), el casquillo de 8 mm (I) y el 5,0 x50mm tornillo FLA (A).

RECOMMENDATION

To fix the furniture to the wall use the fixing bracket (J), the 3.5x14mm FLA (C) screw, the 8mm bushing (I) and the 5.0x50mm FLA (A).

1º

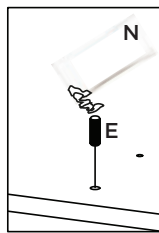
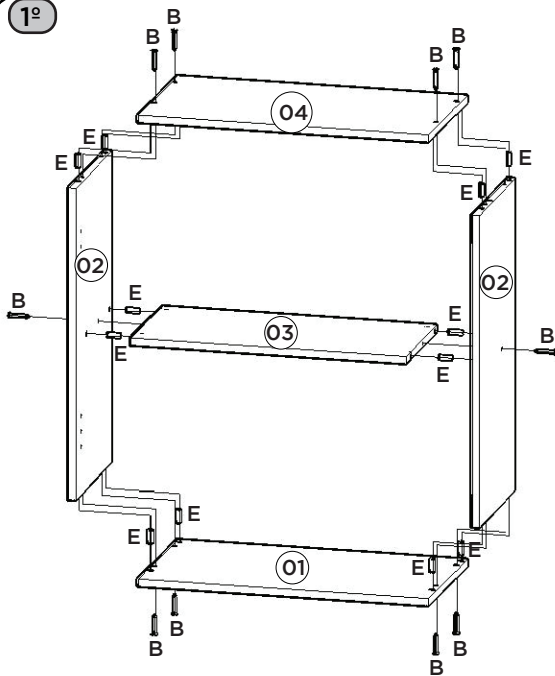

Utilizar o sachê de cola (N) em todas as cavilhas (E) do produto.

Con el pegamento sobre (N) en todos los pernos (E) producto.

Use the glue sachet (N) on all the pegs (E) of the product.

AVISO

Para limpeza de seu móvel, use uma flanela seca ou umedecida, e não utilize produtos químicos que possam danificar seu produto.

SISTEMA DE MONTAGEM

O sistema de montagem dos produtos, funciona de acordo com a ordem crescente dos números indicados no desenho. Ex: 01, 02, 03, 04... até a conclusão da montagem.

ADVERTENCIA

Para limpieza de su móvil, use una franela seca o húmeda, y no utilice productos químicos que puedan dañar su producto.

SISTEMA DE MONTAJE

El sistema de montaje de los productos funciona de acuerdo con el orden creciente de los números indicados en el dibujo. Ej.: 01, 02, 03, 04... hasta la conclusión del montaje.

2º

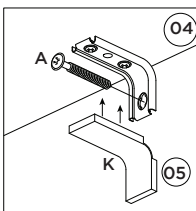
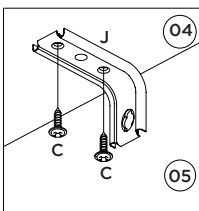
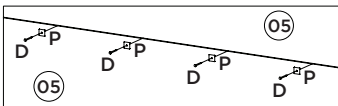
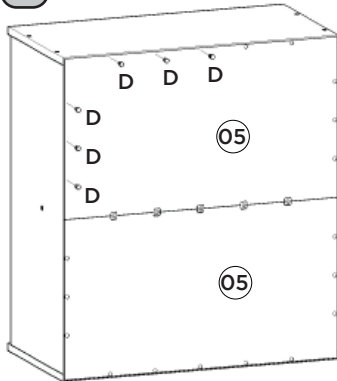

3º

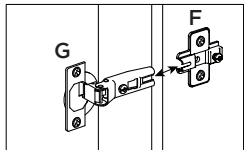
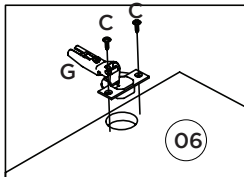
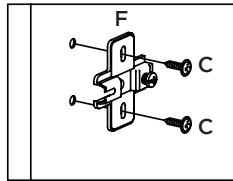

Video: Instalar e regular Dobradiças

Video: Instale y ajuste las bisagras

Video: Install and adjust hinges

NOTICE

To clean your furniture, use a dry or wet cloth, and do not use chemicals that may damage your product.

ASSEMBLY SYSTEM

The products' assembly system works according to the increasing order of the indicated numbers. For example: 01, 02, 03, 04 ... to the end of the assembly.

