

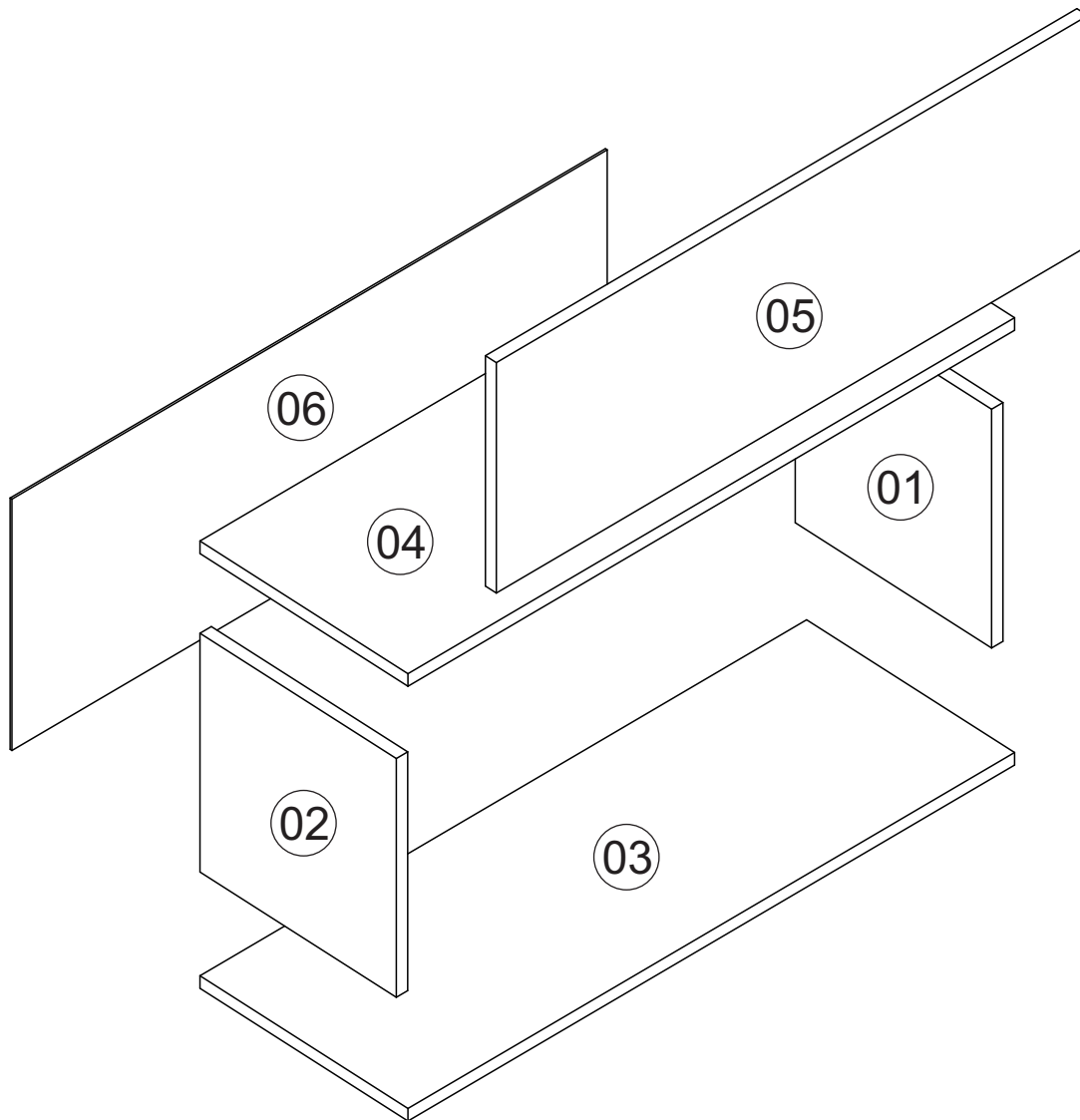

Rodovia SC-492 - Km 10 - B. Industrial  
 89905-000 - Bandeirante - SC  
 Fone: (49) 3622-4549  
 e-mail: mxmoveis@mxmoveis.com.br

**Ref. AGL01**

**Aéreo 800 Basic**  
**Armario 800**  
**Air 800**  
**Cozinha/Cocina**  
**GLORIA**

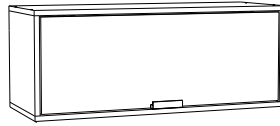

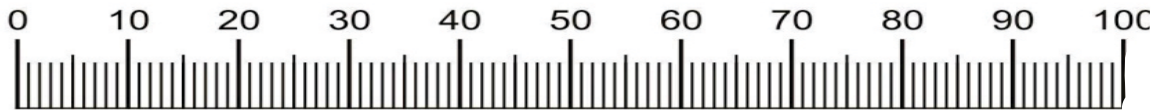
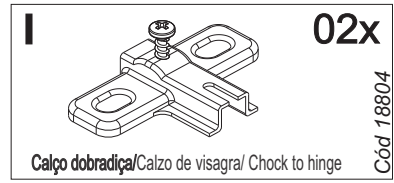
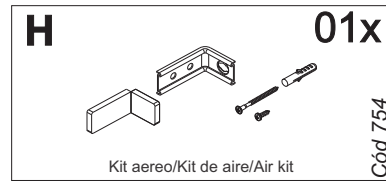
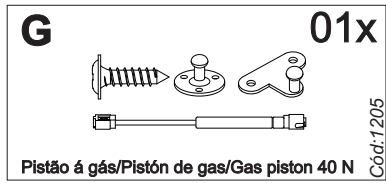
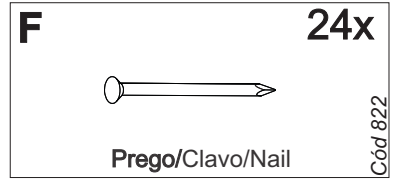
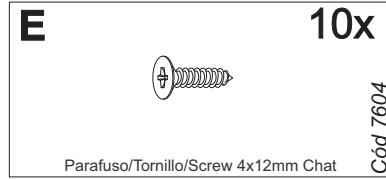
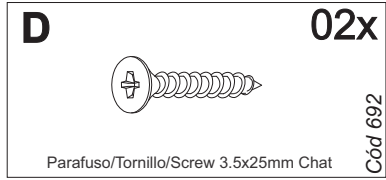
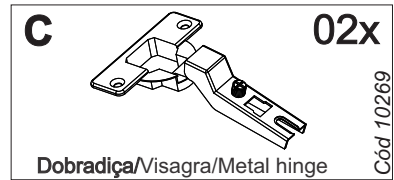
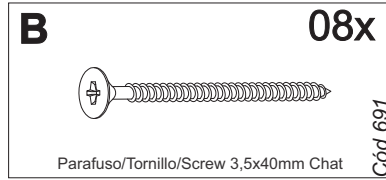

Nº	CÓDIGO CODE ASSISTÊNCIA ATTENDANCE	NOME DA PEÇA/DESCRIPCIÓN PIEZAS/DESCRIPTION PARTS	MEDIDAS (mm) MEASURES (mm)	QTD.	CASTANHO CASTANHO
01	AGL01.17.00	Lateral externa direita/Lateral derecha/Right side	285x300x15	01	263410
02	AGL01.18.00	Lateral externa esquerda/Lateral izquierda/Left side	285x300x15	01	263374
03	AGL01.01.00	Base Inferior/Base/Shelf	800x300x15	01	263371
04	AGL01.05.00	Base superior/Base superior/Shelf	800x300x15	01	263372
05	AGL01.25.00	Porta/Puerta/Door	762x277x15	01	263375
06	AGL01.13.00	Forro/Revés/botton	786x301x2.5	01	260547

# Ferragens/Herrajes/Hardware

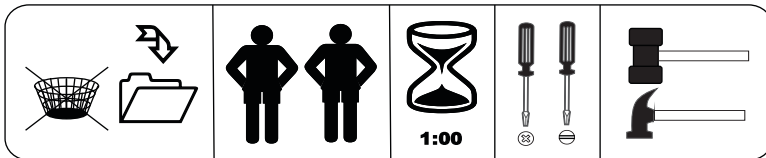

Medidas em mm  
Measures in mm  
Meduras en mm



 **Giz para madeira**  
Produto para ser aplicado em caso de riscos na superfície.

 **Giz para madeira**  
Product to be applied in case of scratches on the surface.

 **Giz para madeira**  
Producto para ser aplicado en caso de rayas en la superficie.

## Pré-Montagem/Preparación Piezas/ Pre-assembly

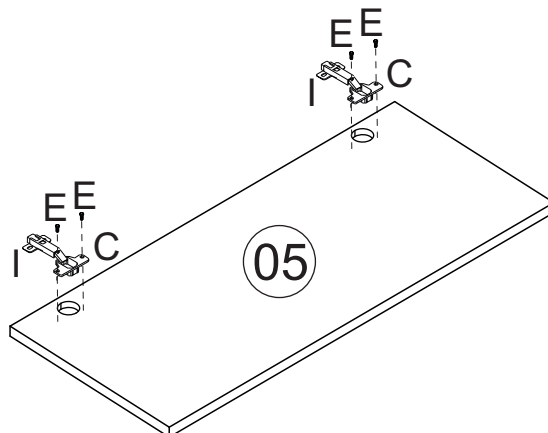

**01** Montagem/Montaje/Assembly

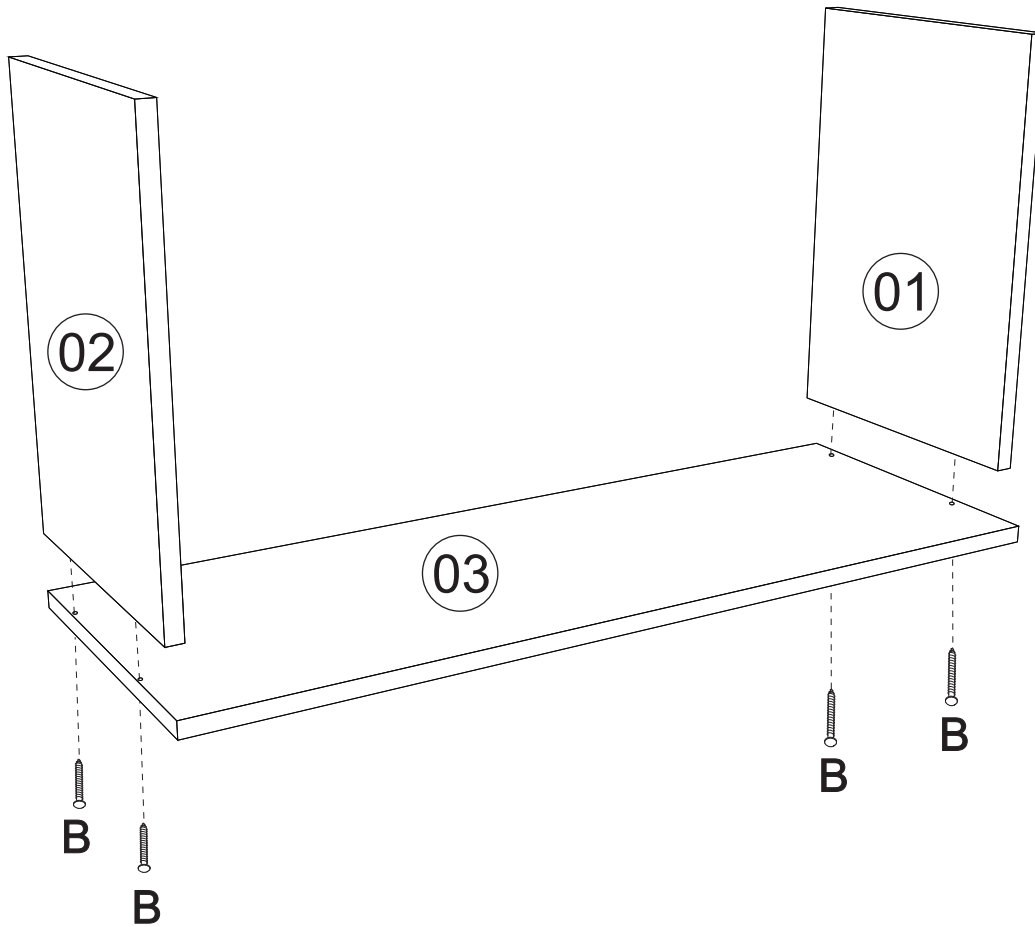

**02** Montagem/Montaje/Assembly

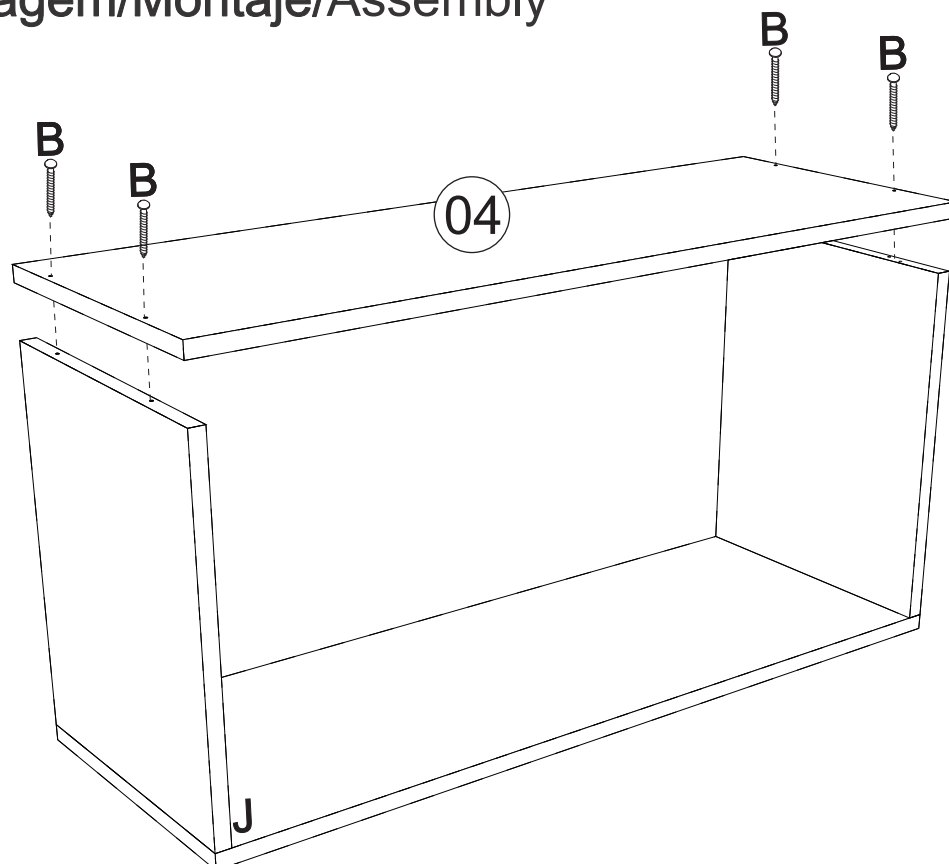

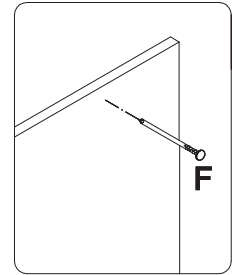
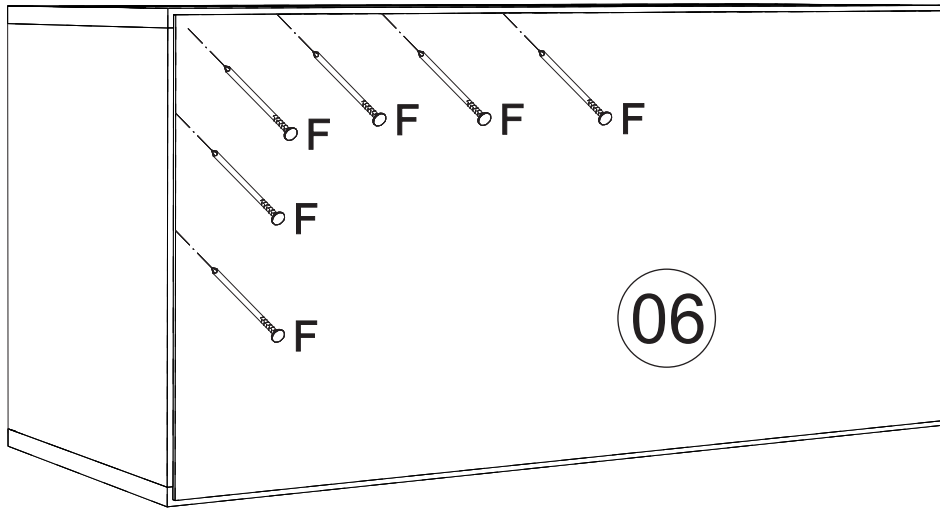
**03****Montagem/Montaje/Assembly**

- \*Colocar um prego (F) a cada 100mm
- \*Colocar un clavo cada (F) 100mm
- \*Place a nail every (F) 100mm

**04****Montagem/Montaje/Assembly**

Obs: Centralizar o puxador na porta.  
 Nota: Centre la manija en la puerta.  
 Note: Center the handle on the door.

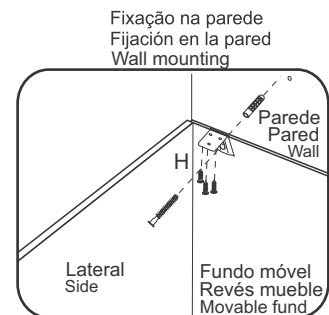
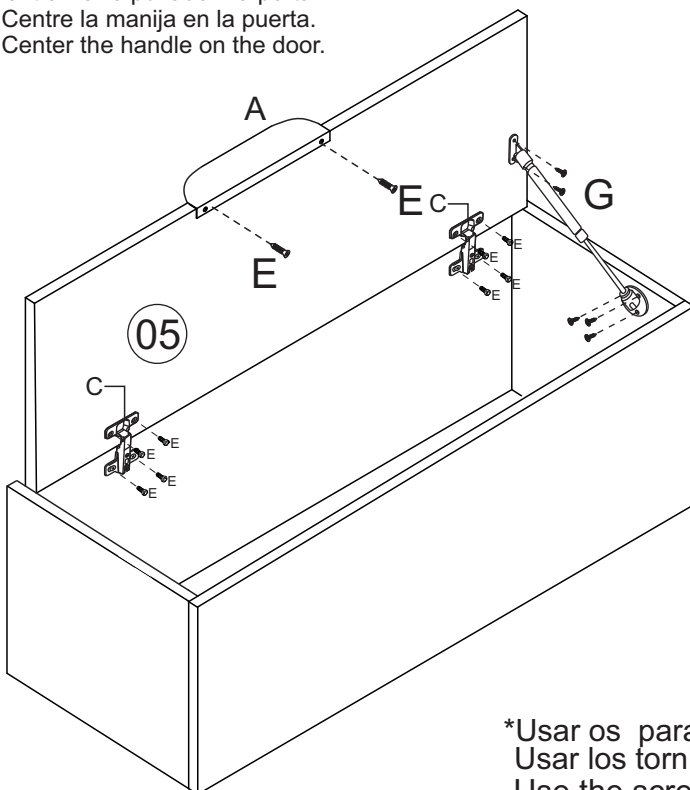

- \*Fixar a cantoneira na parte interna do móvel.
- Fijar la pieza «G» en el interior del mueble.
- \*Attach the corner bracket to the inside of the furniture.

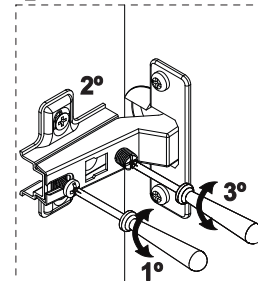
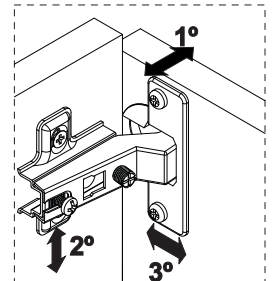
**1°****2°**

- \*Usar os parafusos (D) para unir este módulo a outro.
- Usar los tornillos (D) para unirse este modulo a otro.
- Use the screws (D) to join this module to another.