

AE2080

DATA/FECHA/DATE: 08/03/2020
 REVISÃO/REVISIÓN/REVISION: 03

INSTRUÇÕES DE MONTAGEM
INSTRUCCIONES DE MONTAJE
ASSEMBLY'S INSTRUCTIONS
 WWW.ARTINMOVEIS.COM.BR

ART  MÓVEIS









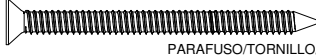

Soluções Criativas para o seu lar

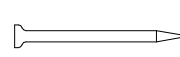
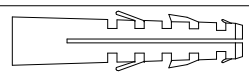
Rua Joni José Bozzeto, 300 - Bairro Tamandaré
 Garibaldi | RS | CEP: 95720-000 | Fone / Fax: 54.3464.7071

AÉREO COM 2 PORTAS SUN
AEREO CON 2 PUERTAS SUN
WALL CABINET WITH 2 DOORS SUN

LISTA DE PEÇAS/LISTA DE PIEZAS/FURNITURE PIECES LIST

COD	DESCRIÇÃO/DESCRIPCIÓN/DESCRIPTION	DIM/DIM/DIM	QTD
01	LATERAL/LATERAL/SIDE	484x274x15	2
02	TAMPO/TAPA/TOP	904x274x15	2
03	PRATELEIRA/ESTANTE/SHELF	904x258x15	1
04	PORTA/PUERTA/DOOR	448x448x15	2
05	COSTA/FONDO/BACK	920x470x03	1

REF	DESCRIÇÃO/DESCRIPCIÓN/DESCRIPTION	QTD
A	 CAVILHA CLAVIA WOOD DOWEL Ø6X30	12
B	 PARAFUSO/TORNILLO/SCREW Ø3,5X40	08
C	 PARAFUSO/TORNILLO/SCREW Ø3,5X14	20
D	 PREGO CLAVO NAIL 10X10	40
E	 BUCHA PLÁSTICA CASQUILLO BUSHING	02
F	 PARAFUSO/TORNILLO/SCREW Ø5X50	02
G	 PROTEÇÃO P/ SUPORTE CANTONEIRA PROTECCIÓN ANGLE BRACKET	02
H	 SUPORTE FIXAÇÃO SOPORTE DE FIJACIÓN FIXING SUPPORT	02
I	 DOBRADIÇA CANECO Ø26 ALTA - CALÇO 12 BISÁGRA HINGE	04
J	 COLA PEGAMENTO GLUE	01
K	 ADESIVO TAPA FURO ADHESIVO STICKER	08
L	 ETIQUETA ART IN MOVEIS ETIQUETA ART IN MOVEIS ADHESIVE ART IN MOVEIS	01
M	 PUXADOR TIRADOR PULL	02

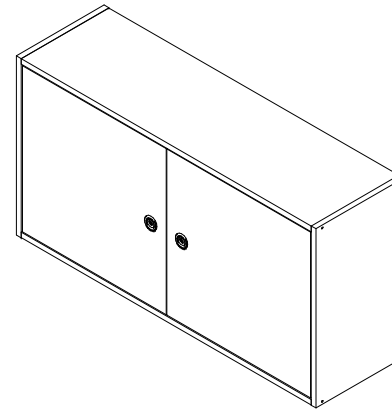
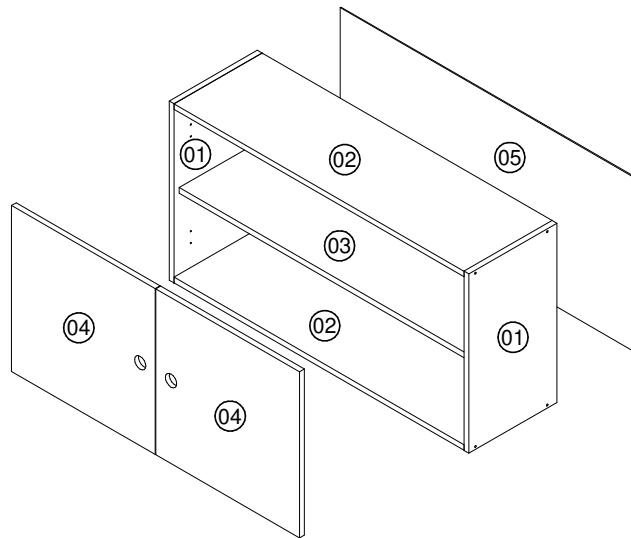

FERRAMENTAS NECESSÁRIAS:
HERRAMIENTAS NECESARIAS:
NECESSARY TOOLS:



"IMPORTANTE LER COM ATENÇÃO E GUARDAR PARA EVENTUAIS CONSULTAS".
"IMPORTANTE LEER CON ATENCIÓN Y GUARDAR PARA EVENTUALES CONSULTAS".
"IMPORTANT TO READ CAREFULLY AND SAVE FOR ANY QUERIES".

INSTRUÇÕES DE MONTAGEM
INSTRUCCIONES DE MONTAJE
ASSEMBLY'S INSTRUCTIONS

RECOMENDAÇÕES:

01 - Examine completamente todas as peças do móvel antes de iniciar o trabalho.

02 - Recomenda-se montar o móvel conforme este Manual de Montagem.

03 - É de responsabilidade do montador seguir as instruções do Manual de Montagem, que são fundamentais para garantir a estrutura do móvel.

04 - Certifique-se de que todos os acessórios utilizados na montagem (parafusos, porcas, ponteiros) estejam fixados o suficiente, totalmente atarraxados, evitando que venham a provocar ferimentos.

LIMPEZA:

01 - Pano levemente umedecido com água, seguido de pano seco.

02 - Não utilizar produtos químicos ou abrasivos.

GARANTIA:

01 - 3 meses para defeitos ou vícios de origem.

ADVERTÊNCIAS:

01 - Esteja ciente do risco de chama aberta e outras fontes de calor, tais como aquecedores elétricos, aquecedores a gás etc. nas proximidades do produto.

02 - Não utilize o produto se alguma parte estiver quebrada, rasgada ou faltando. Utilizar somente peças de reposição aprovadas pelo fabricante.

RECOMENDACIONES:

01 - Examine completamente todas las piezas del mueble antes de empezar el montaje.

02 - Recomienda-se montar el mueble de acuerdo con este Manual de Montaje.

03 - Es de responsabilidad del montador seguir las instrucciones del Manual de Montaje, que son fundamentales para asegurar la estructura del mueble.

04 - Asegure-se de que todos los accesorios utilizados en el montaje (tornillos, tuercas, ponteras) estén fijados el suficiente, totalmente roscados, evitando que vengam a provocar lesiones.

LIMPIEZA:

01 - Paño levemente humedecido con agua, siguiendo de paño seco.

02 - No utilizar productos químicos o abrasivos.

GARANTÍA:

01 - 3 meses para defectos o vicios de origen.

ADVERTENCIAS:

01 - Tenga en cuenta el riesgo de llama abierta y otras fuentes de calor, tales como calentadores eléctricos, calentadores de gas, etc. en las proximidades del producto.

02 - No utilice el producto si alguna parte esté rota, o perdida. Utilizar sólo piezas de repuesto aprobadas por el fabricante.

RECOMMENDATIONS:

01 - Check completely all the furniture's pieces before start to assemble it.

02 - It is recommended to assemble this furniture according to this Assembly's Manual.

03 - It is the assembler's responsibility to follow the instructions of this Assembly's Manual, which are essential to ensure the furniture's structure.

04 - Ensure that all the accessories used in the assembly (bolts, nuts, tips) are well and enoughly fixed, completely threaded, avoiding injuries from happening.

CLEANSING:

01 - Cloth slightly moistened with water.

02 - Do not use chemicals or abrasives products.

WARRANTY:

01 - 3 months due to manufacture defects.

WARNINGS:

01 - Be aware of the risk of open flame and other sources of heat, such as electric heaters, gas heaters etc. around the product.

02 - Do not use the product if any part is broken, torn or missing. Only use replacement parts approved by the manufacturer.

AE2080

Instruções de Montagem

Instrucciones de Montaje
Assembly's Instructions

ART  MÓVEIS

Soluções Criativas para o seu lar

