

MU500 - MULTIUSO

Manual de Montagem
 Assembly Instructions
 Instrucción de Montaje

decibal[®]
 móveis

Produto Montado
 Producto final
 Assembled

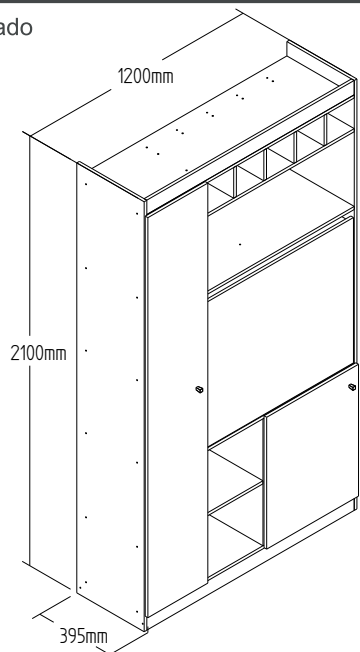

1°

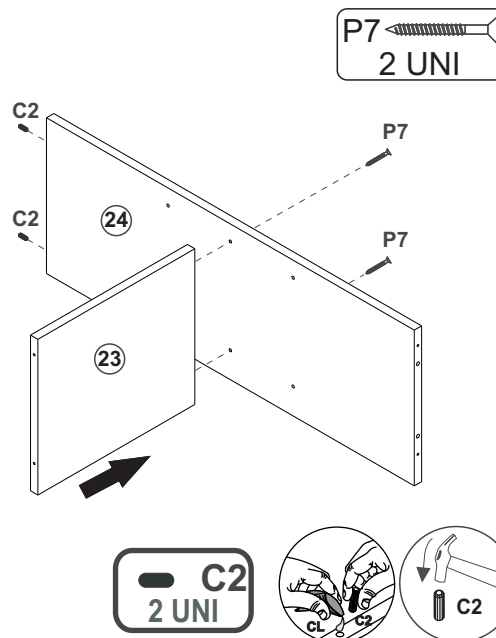

2°

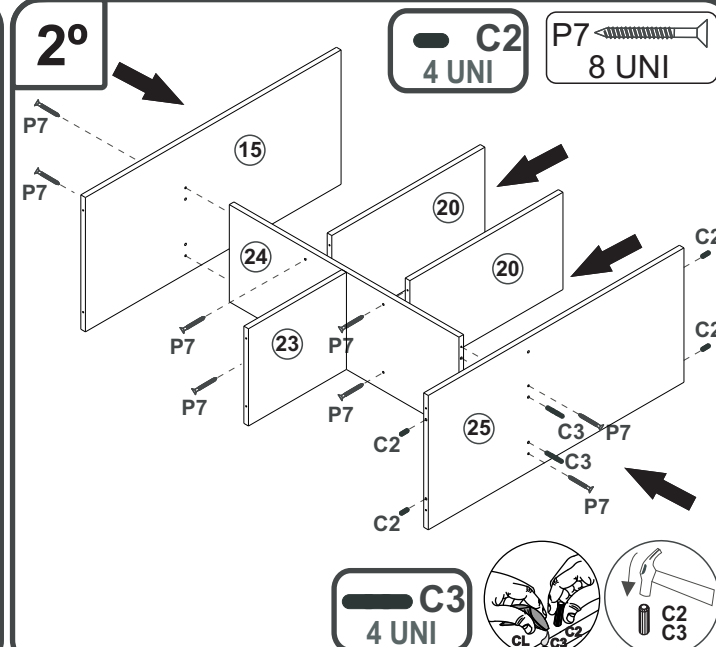

3°

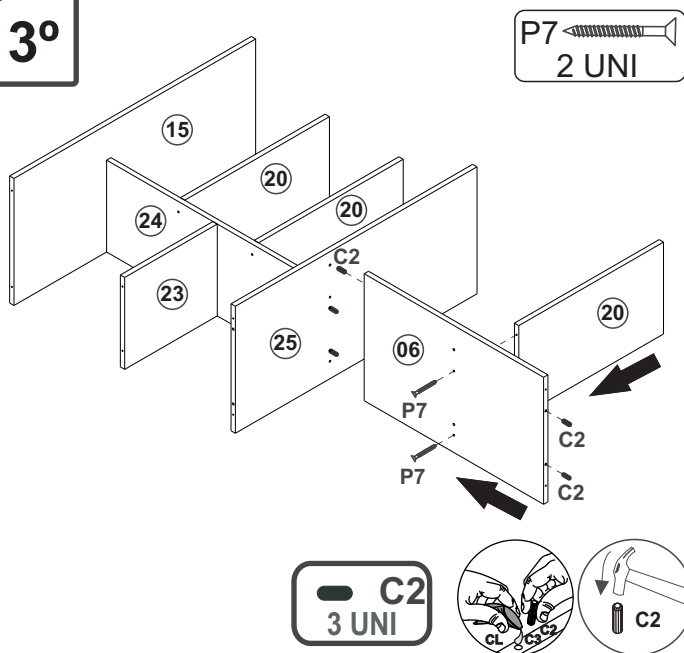

4°

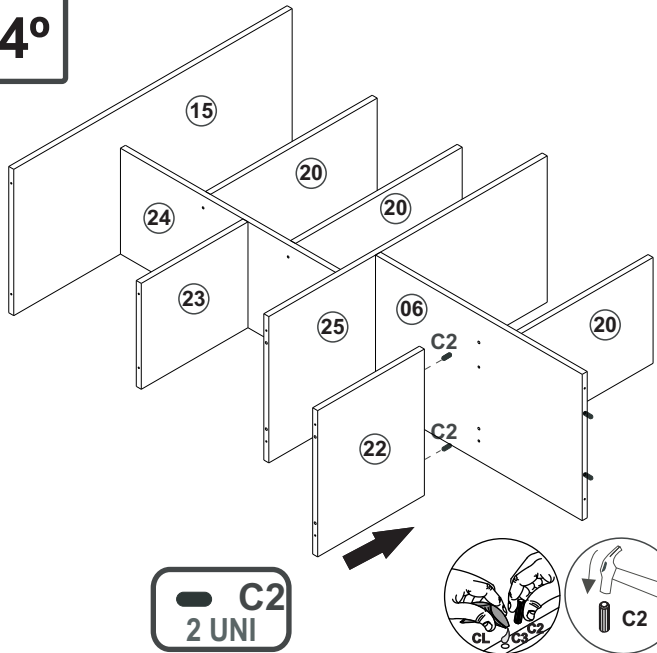

5°

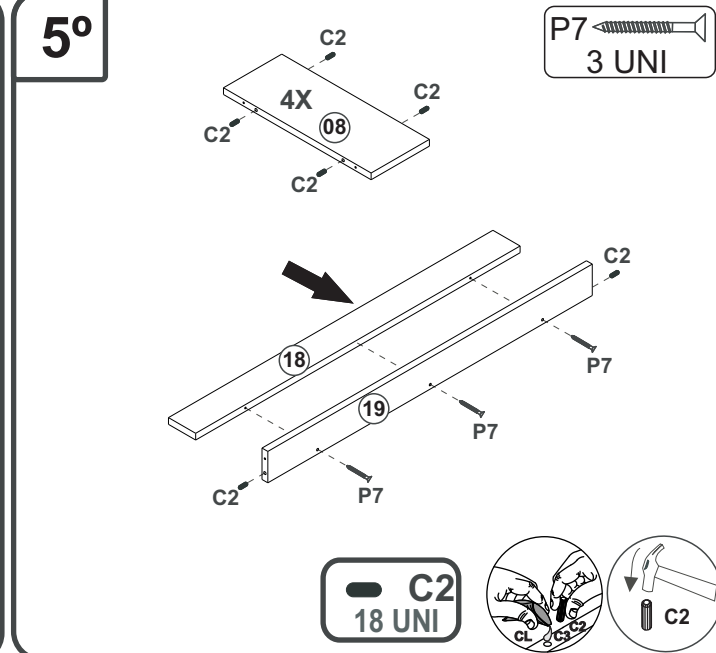

MU500 - MULTIUSO

Manual de Montagem
 Assembly Instructions
 Instrucción de Montaje



10°

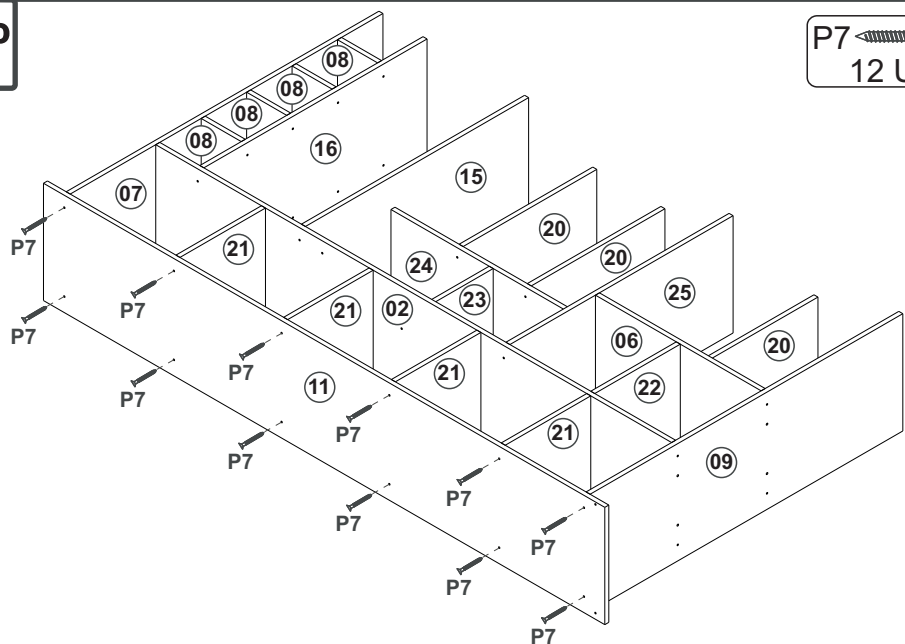

P7 12 UNI

11°

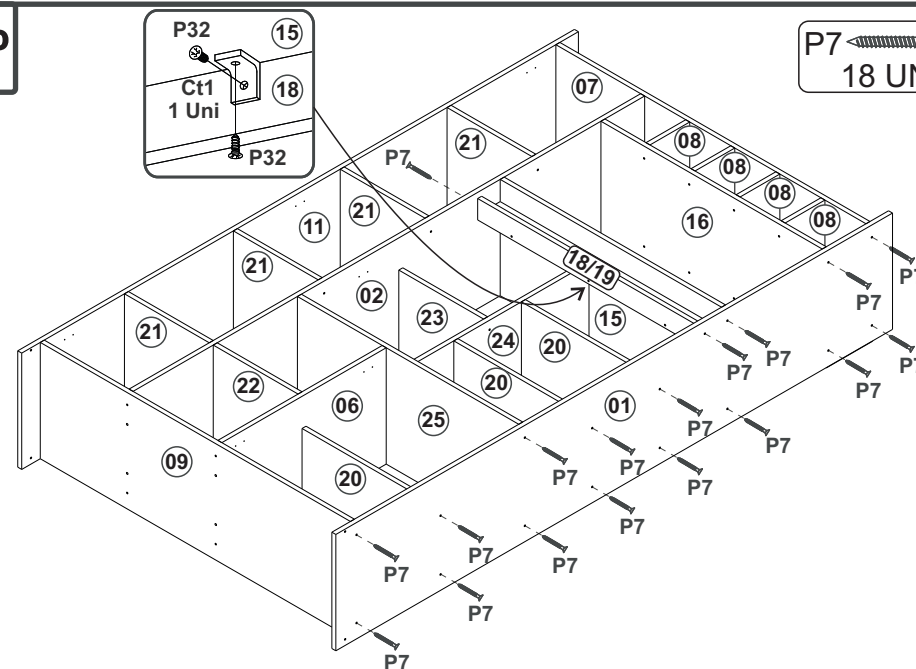

P7 18 UNI

12°

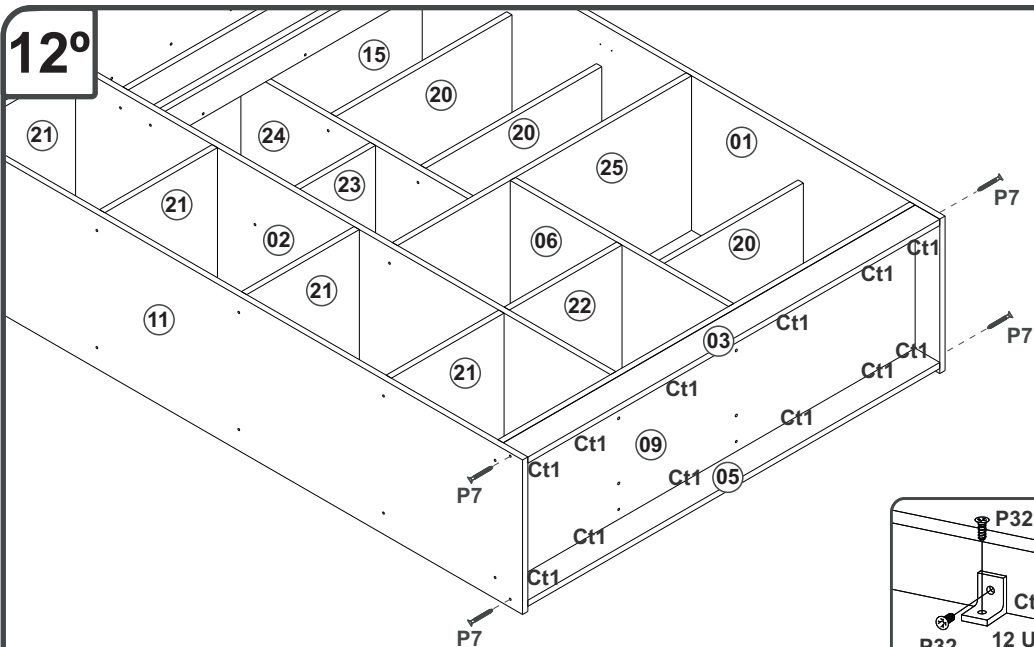

P32 12 Uni

13°

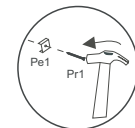
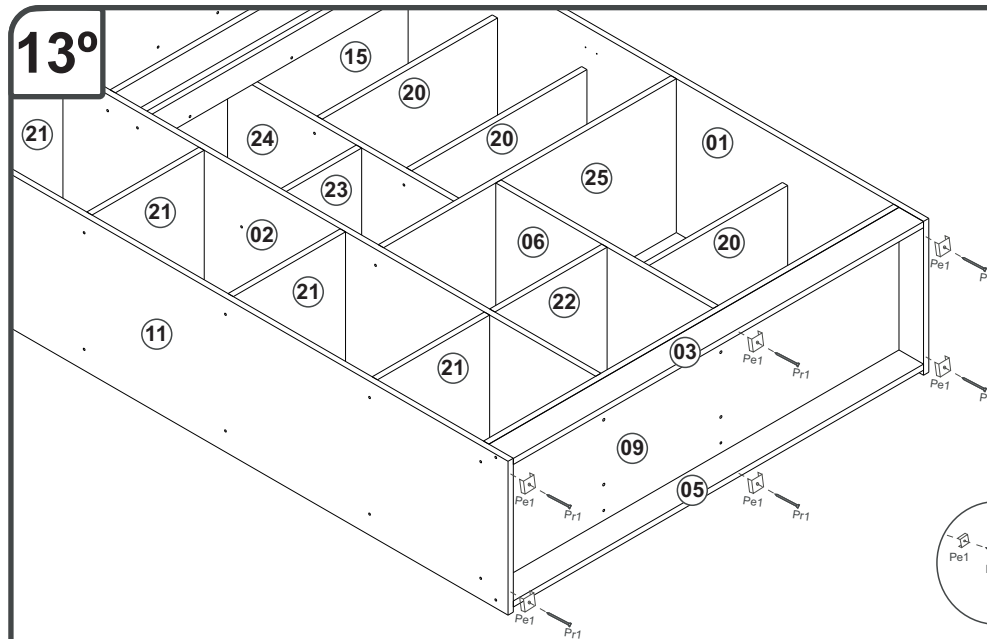

MU500 - MULTIUSO

Manual de Montagem
 Assembly Instructions
 Instrucción de Montaje



14°

COSTA/REVÉS/BACK

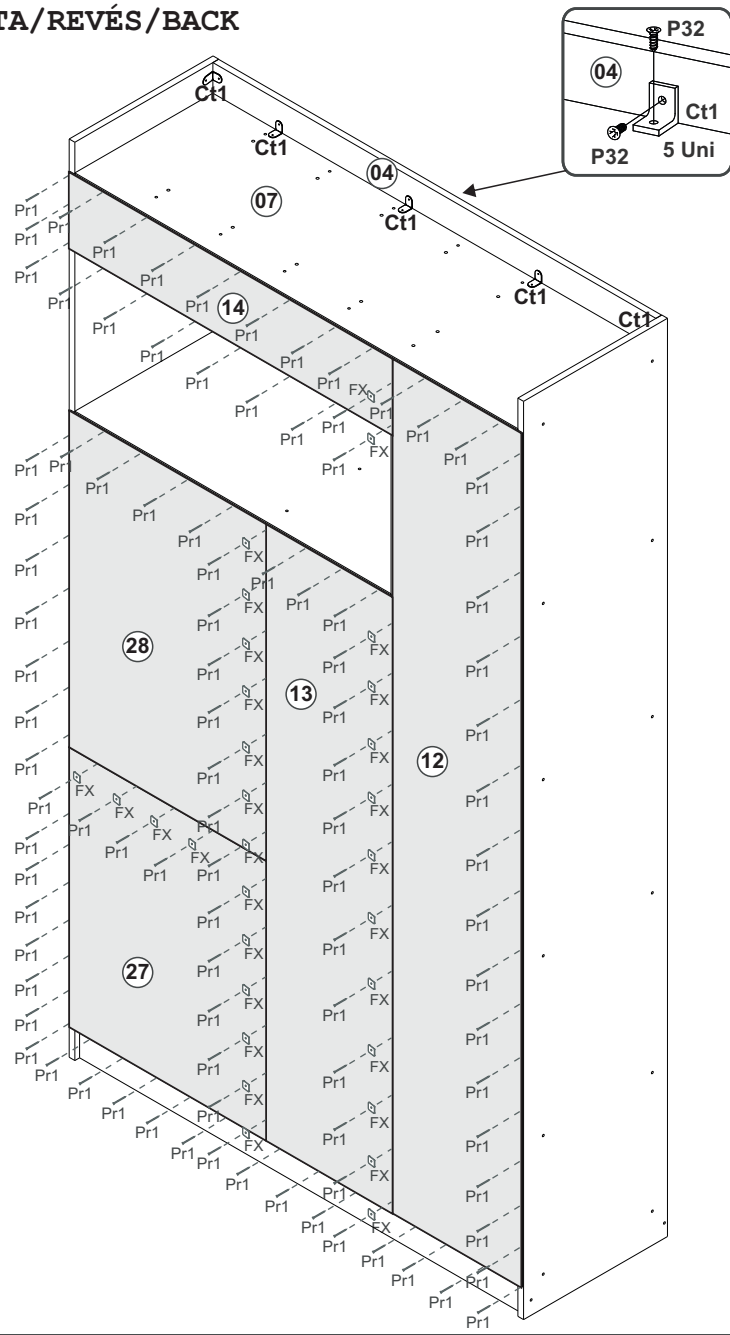
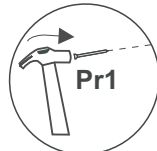

15°

FIXAÇÃO NA PAREDE/ FIJACIÓN EN LA PARED / FIXING ON THE WALL

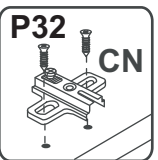
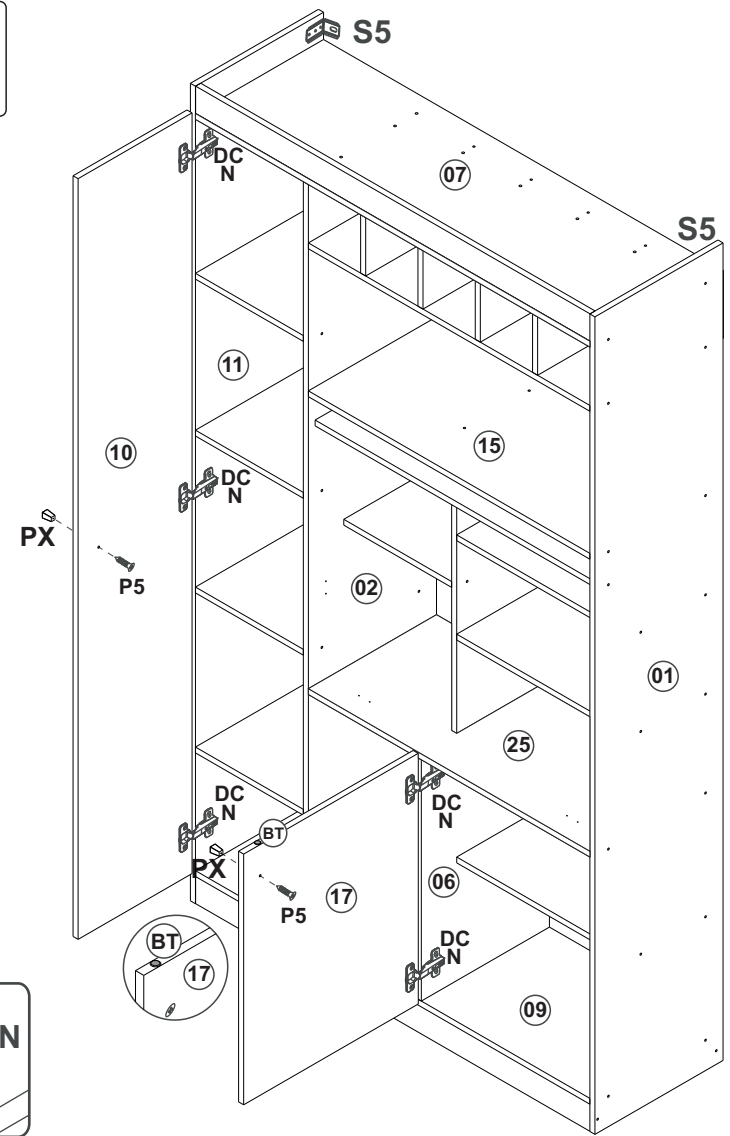
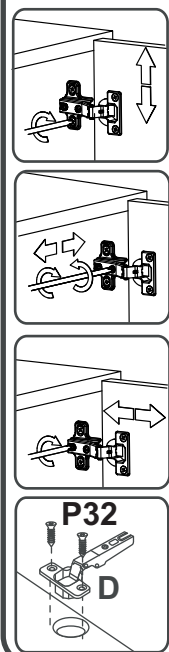
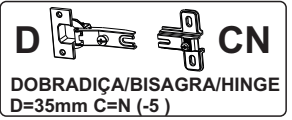
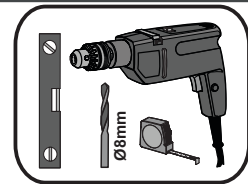
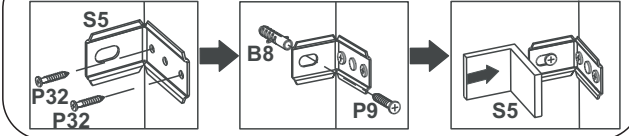

MU500 - MULTIUSO

Manual de Montagem
 Assembly Instructions
 Instrucción de Montaje



16°

D **C8**

DOBRADIÇA/BISAGRA/HINGE D=35mm C=8

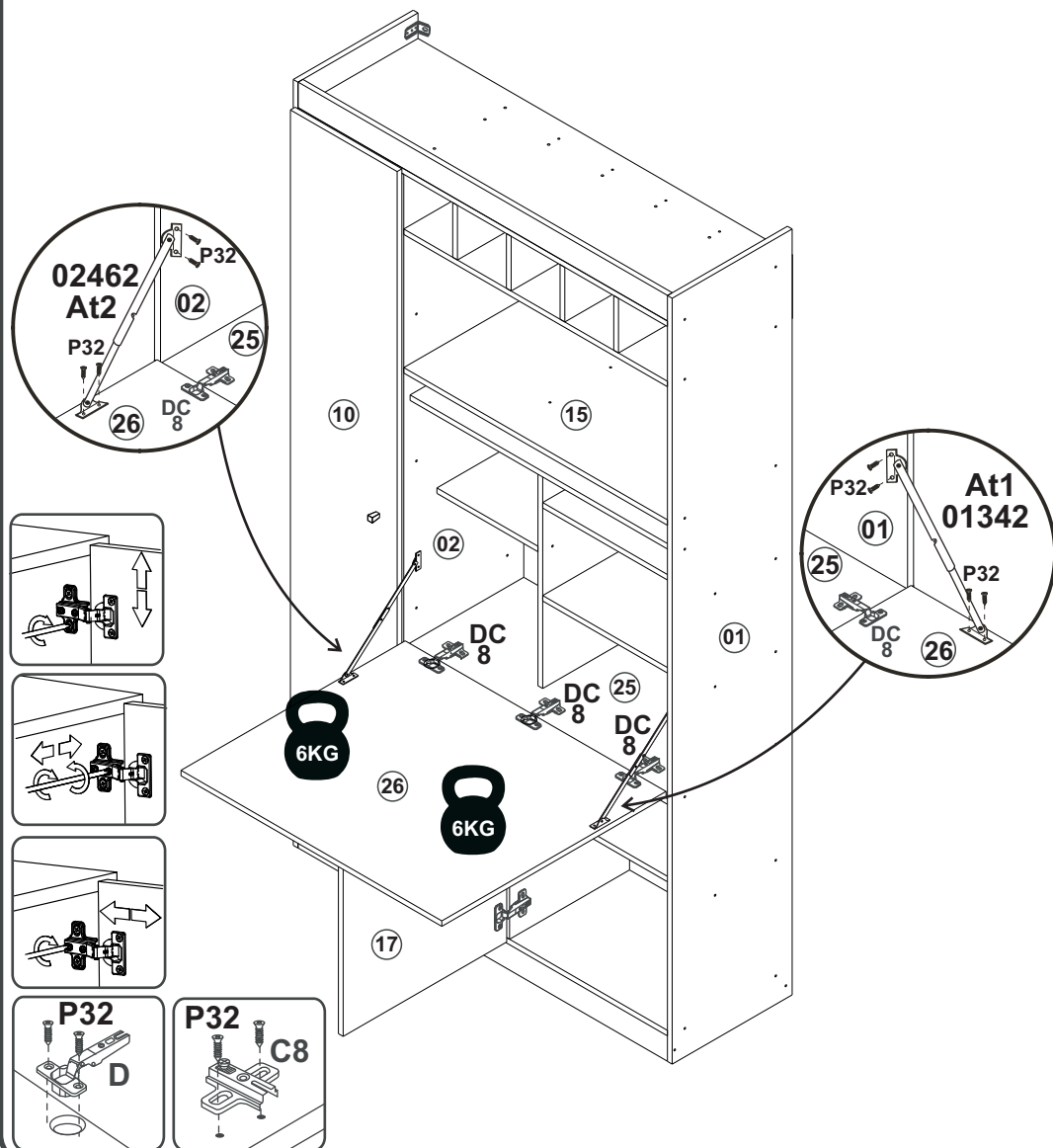

PESO SUPORTADO/PESO SOPORTADO/ WEIGHT SUPPORTED

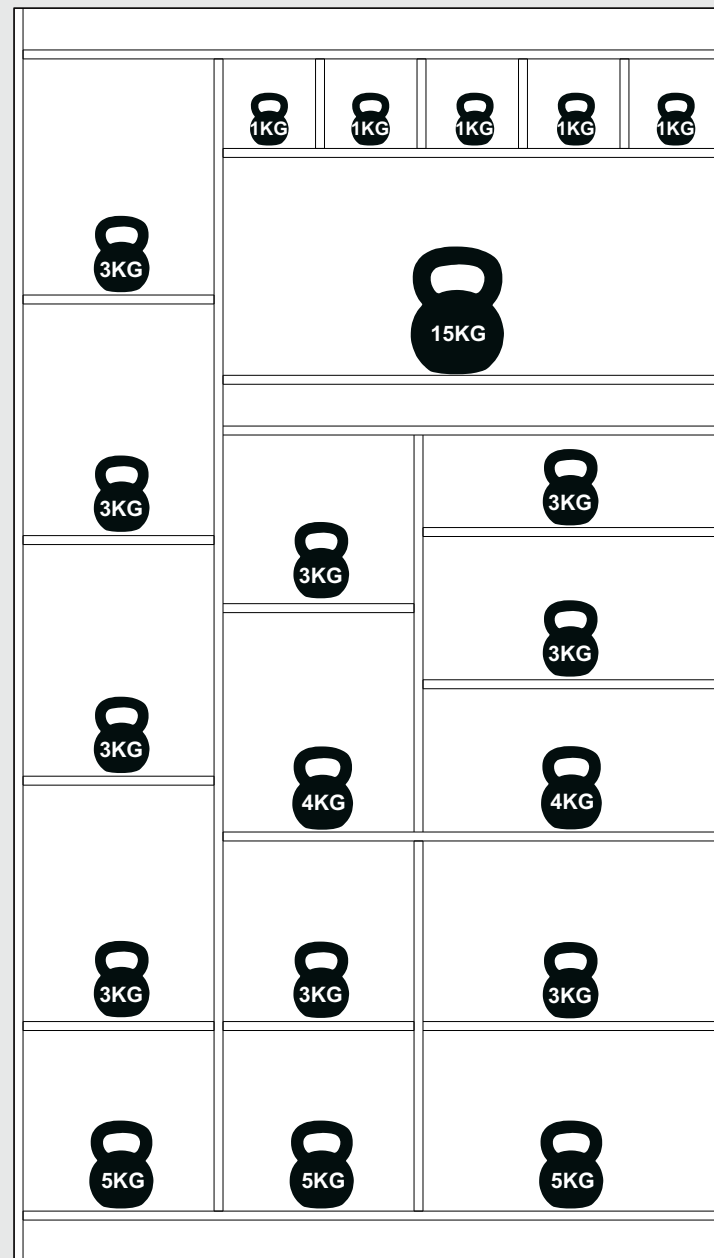

MU500 - MULTIUSO





Manual de Montagem Assembly Instructions Instrucción de Montaje

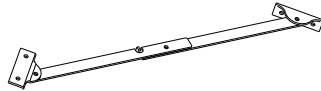

Relação de Peças/ Relación de Piezas/Parts List

Nº	CÓDIGO/CODE	DESCRIÇÃO/DESCRIPCIÓN/DESCRIPTION	QTD/CANT	VOL.
1	0559557	LATERAL DIR/LATERAL/SIDE	2100X380X15MM	1
2	0559559	DIVISORIA MAIOR/DIVIDER	1930X380X15MM	1
3	0559562	RODAPÉ FRT/ZÓCALO/BASEBOARD	1170X70X15MM	1
4	0559563	RODA FORRO/WHEEL LINING/RUEDA DE FORRO	1170X70X15MM	1
5	0559574	RODAPÉ TRS/ZÓCALO/BASEBOARD	1170X70X15MM	1
6	0559561	DIVISORIA MENOR/DIVIDER	620X380X15MM	1
7	0559558	BASE SUP	1170X380X15MM	1
8	0559577	DIVISORIA ADEGA/DIVIDER	380X150X15MM	4
9	0559556	BASE INF	1170X380X15MM	1
10	0559573	PORTA MAIOR /PUERTA/DOOR	1954X338X15MM	1
11	0559575	LATERAL ESQ/LATERAL/SIDE	2100X380X15MM	1
12	0559578	COSTA MAIOR/REVÉS/BACK	1954X340X3,2MM	1
13	0559579	COSTA INT/REVÉS/BACK	1410X334X3,2MM	1
14	0559582	COSTA SUP MAIOR/REVÉS/BACK	855X175X3,2MM	1
15	0559565	PRATELEIRA/ESTANTE/SHELF	835X380X15MM	1
16	0559576	PRAT ADEGA/ESTANTE/SHELF	835X380X15MM	1
17	0559564	PORTA INF/PUERTA/DOOR	644X518X15MM	1
18	0559566	TRAVESSA TRS/TRAVIESA/TRVERSE	835X70X15MM	1
19	0559567	TRAVESSA FRT/TRAVIESA/TRVERSE	835X70X15MM	1
20	0559572	PRAT MAIOR SUP/ESTANTE/SHELF	500X275X15MM	3
21	0559569	PRAT MENOR/ESTANTE/SHELF	380X320X15MM	4
22	0560449	PRAT EXT/ESTANTE/SHELF	380X320X15MM	1
23	0559571	PRAT MENOR SUP/ESTANTE/SHELF	320X275X15MM	1
24	0559570	DIV SUP MAIOR/DIVIDER	750X275X15MM	1
25	0559560	PRAT MAIOR/ESTANTE/SHELF	835X380X15MM	1
26	0559568	PORTA SUP/PUERTA/DOOR	826X710X15MM	1
27	0559580	COSTA INF/REVÉS/BACK	640X520X3,2MM	1
28	0559581	COSTA SUP MENOR/REVÉS/BACK	770X520X3,2MM	1

Escala (N/A)

LEGENDA	DESCRIÇÃO/DESCRIPCIÓN/DESCRIPTION	CÓDIGO	QUANT.
At1	 ARTICULADOR/ARTICULATOR	01342 DIR	01
At2	 ARTICULADOR/ARTICULATOR	02462 ESQ	01
PX	 PUXADOR/PEGADOR/HANDLE (PUX PONT REF 160)	12199 CHAMPAGNE	02
BT	 SILICONE/TAPON SILICONA/STOPPER 13X14mm	10101	01
B8	 BUCHA/BUJE/BUCHING	01311	02

www.decibal.com.br

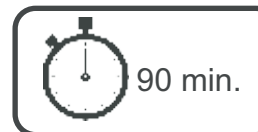

ATENÇÃO!!!! montadores e consumidores

* Para limpar o móveis utilize somente um pano úmido (umedecido em água pura ou água com sabão neutro). Depois, passe um pano seco. Evite a umidade excessiva.
* Evite usar álcool, água sanitária, detergente e outros produtos químicos, mesmo diluídos em água. Não utilize produtos abrasivos de nenhuma espécie

ATENCIÓN!!!! montadores e consumidores

* Para limpiar el mueble utilice solamente un paño húmedo (humedecido con agua limpia o con un jabón suave). A continuación, utilice un paño seco. Evite el exceso de humedad.
* Evite uso de alcohol, hipoclorido solución basada, detergente y otros productos químicos, mismo diluídos en agua. No utilice productos abrasivos de ningún tipo.

ATTENTION!!!! assemblers and consumers

* To clean the furniture, use only a damp cloth (humidify it only in pure water or water and neutral soap). After, use a dry cloth. Avoid excessive humidity.
* Avoid using alcohol, bleach, detergent and other chemical products, even diluted in water. Do not use any kind of abrasive cleaning agents to clean the furniture.
* The use of such products may jeopardize the final characteristics of the furniture.

ATENÇÃO!!!! montadores e consumidores

* Ajustar o torque da parafusadeira para não danificar as peças escareando o parafuso *

ATENCIÓN!!!! montadores e consumidores

* Ajuste el torque del destornillador para no dañar las piezas avallanando el tornillo *

ATTENTION!!!! assemblers and consumers









* Adjust the torque of the screwdriver so as not to damage the parts by countersinking the screw *

MU500 - MULTIUSO

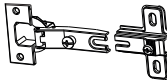
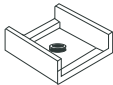
Escala (1:1)

LEGENDA	DESCRIÇÃO/DESCRIPCIÓN/DESCRIPTION	CÓDIGO	QUANT.
P7	 PARAFUSO/TORNILLO/SCREW 4X45	01318	87
Pr1	 PREGO/CLAVO/NAIL 10X10	01330	140
C2	 CAVILHA/TARUGO/DOWEL 6X30 MM	01211	50
P32	 PARAFUSO/TORNILLO/SCREW 4X14(CAB FLAG)	12412	80
C3	 CAVILHA/TARUGO/DOWEL 6X50 MM	01212	04
P5	 PARAFUSO/TORNILLO/SCREW 3,5X25	09955	02
P9	 PARAFUSO/TORNILLO/SCREW 6X50	03827	02

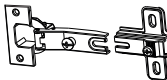
Escala (N/A)

LEGENDA	DESCRIÇÃO/DESCRIPCIÓN/DESCRIPTION	CÓDIGO	QUANT.
CL	 COLA/PEGAMENTO/GLUE	01213	01
Ct1	 CANTONEIRA/PIEZA L/SHEET	03077	18
DC N	 DOBRADIÇA/BISAGRA/HINGE D=35mm C=N (-5)mm	03493	05
Pe1	 PÉ/PATA/FOOT	01367	06
S5	 SUPORTE AÉREO/APOYO AÉREO/AIR SUPPORT AVELA 11191	03828	02
ET	 ETIQUETA LOGO DECIBAL/LABEL DECIBAL	01312	01
FX	 FIXADOR COSTA/FIJADOR FONDO/FIXER COAST	01331	30
DC 8	 DOBRADIÇA/BISAGRA/HINGE D=35mm C=8mm	04043	03
AD	 ADESIVO/ADHESIVO/ADHESIVE 15mm	NATURALLE 09963	58

Ferramenta necessárias
Necessary tools
Herramientas necesarias

