

AC4005 - KIT COZINHA

Manual de Montagem
 Assembly Instructions
 Instrucción de Montaje

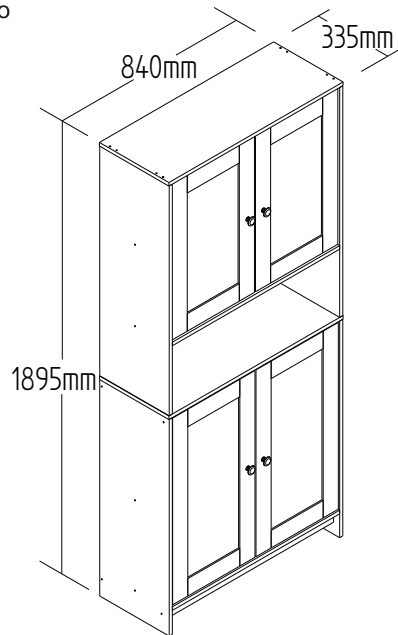

Produto Montado
 Producto final
 Assembled



1º

- P7** 04 UN
- C2** 04 UN
- B** 04 UN

2º

- P7** 02 UN
- C2** 01 UN
- B** 02 UN

3º

- P7** 06 UN
- C2** 05 UN
- B** 06 UN

4º

- P12** 12 UN
- Ct1** 06 UN

- Pr1** 06 UN

- Pe1** 06 UN

5º

- FX** 06 UN
- Pr1** 33 UN
- P1** 05 UN

AC4005 - KIT COZINHA

Manual de Montagem
 Assembly Instructions
 Instrucción de Montaje

decibal®

6°

P7
04 UN

C2
08 UN

B
04 UN

7°

P7
04 UN

C2
04 UN

10°

P12
20 UN

Ct1
10 UN

8°

P7
02 UN

C3
04 UN

9°

FX
12 UN

Pr1
47 UN

P12

Ct1

AC4005 - KIT COZINHA

Manual de Montagem
 Assembly Instructions
 Instrucción de Montaje



11°

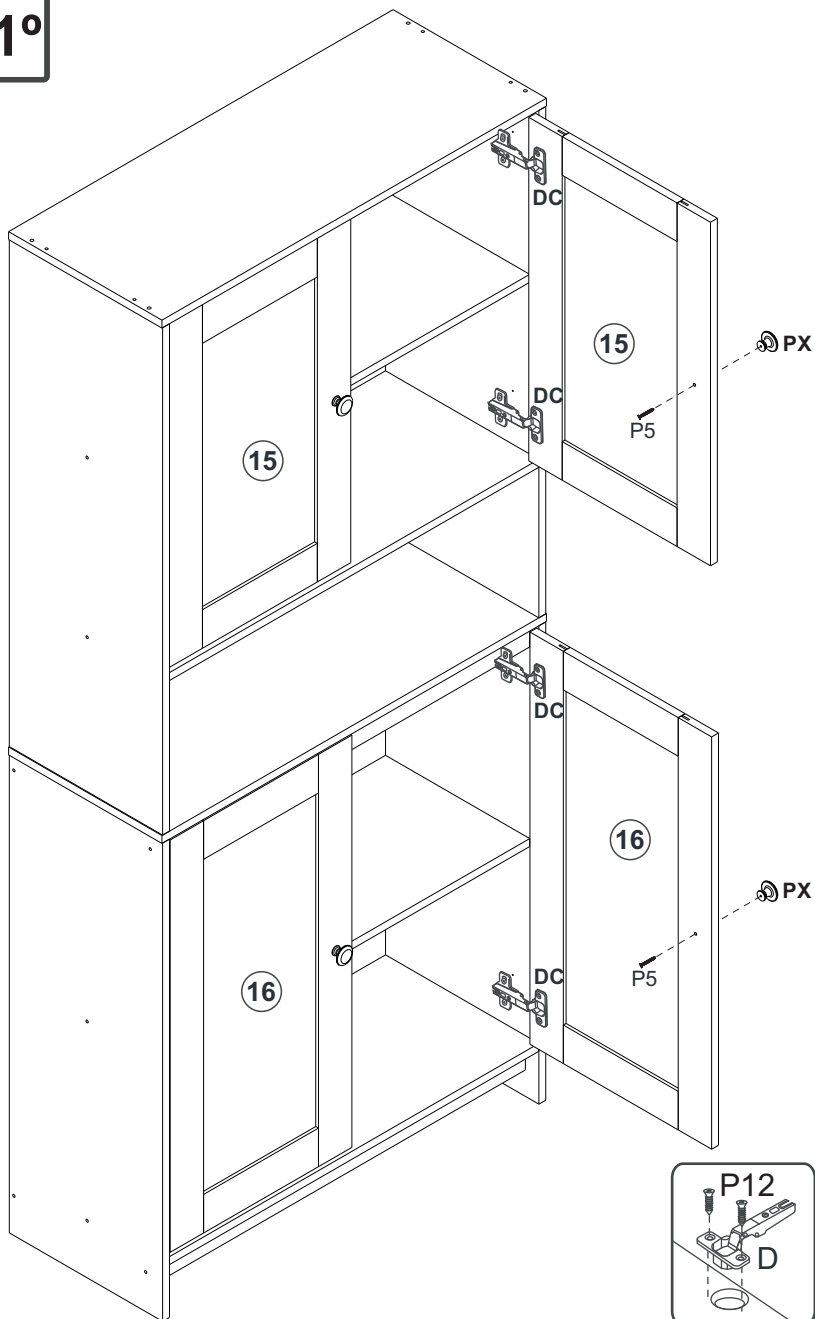

- P12
32 UN
- Dc1
08 UN
- P5
04 UN
- PX
04 UN

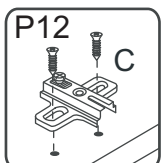
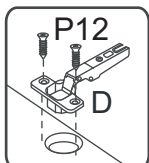
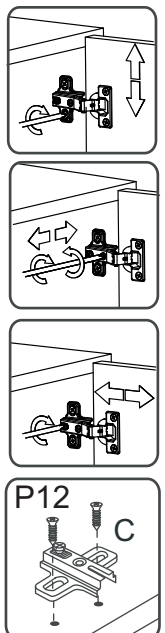

12°

PESO SUPORTADO/PESO SOPORTADO/ WEIGHT SUPPORTED

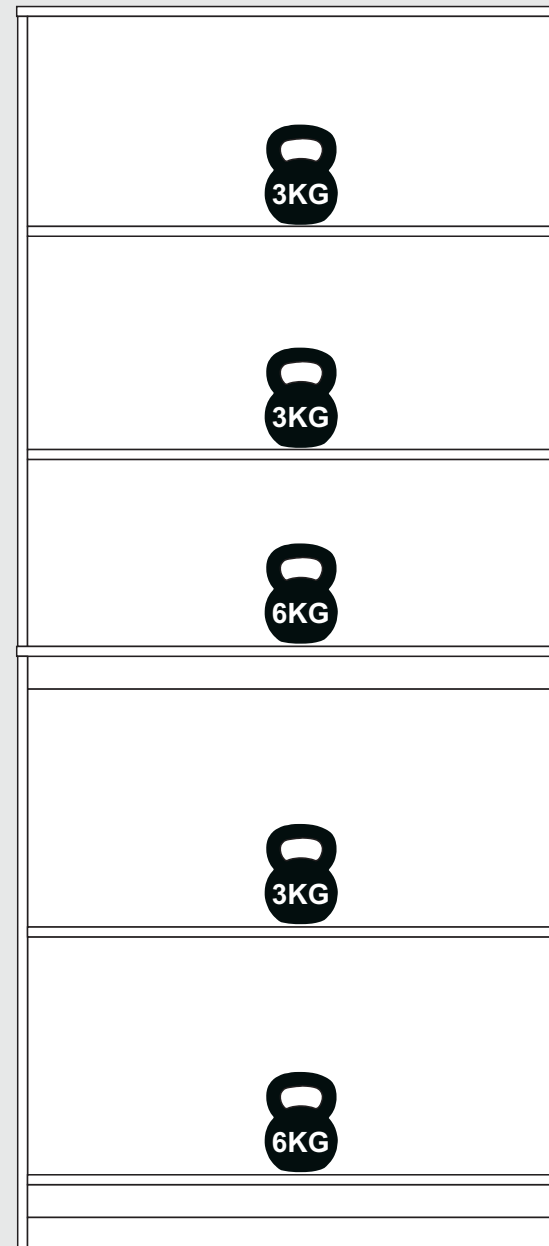

AC4005 - KIT COZINHA

Manual de Montagem
Assembly Instructions
Instrucción de Montaje

decibal[®]
móveis

Relação de Peças/ Relación de Piezas/Parts List

N°	CÓDIGO/CODE	DESCRIÇÃO/DESCRIPCIÓN/DESCRIPTION	QTD/CANT	VOL.
1	0565887	BASE INF 807X335X15MM	1	1
2	0565882	TAMPO/TAPA/TOP 840X335X15MM	1	1
3	0565881	BASE SUP 840X335X15MM	1	1
4	0565891	PRATELEIRA/ESTANTE/SHELF 807X315X15MM	1	1
5	0565890	BASE MEIO SUP 807X335X15MM	1	1
6	0565883	LATERAL DIR SUP/LATERAL/SIDE 960X335X15MM	1	1
7	0565884	LATERAL ESQ SUP/LATERAL/SIDE 960X335X15MM	1	1
8	0565888	TRAVESSA FRONTAL/PLATTER/PLATO 807X50X15MM	1	1
9	0565903	TRAVESSA INF/PLATTER/PLATO 807X50X15MM	1	1
10	0565903	RODAPÉ TRS/ZÓCALO/BASEBOARD 807X100X15MM	1	1
11	0565892	PRATELEIRA SUP/ESTANTE/SHELF 807X315X15MM	1	1
12	0565889	TRAVESSA TRS/PLATTER/PLATO 807X50X15MM	1	1
13	0565886	LATERAL ESQ INF/LATERAL/SIDE 905X335X15MM	1	2
14	0565885	LATERAL DIR INF/LATERAL/SIDE 905X335X15MM	1	2
15	0565905	PORTA DE VIDRO/PUERTA/DOOR 650X397X15MM	2	2
16	0565904	PORTA MOLDURA/PUERTA/DOOR 780X397X15MM	2	2
17	0565900	COSTA MENOR SUP/REVÉS/BACK 831X340X2, 8MM	2	2
18	0565901	COSTA INF/REVÉS/BACK 831X382X2, 8MM	2	2
19	0565902	COSTA MEIO/REVÉS/BACK 831X307X2, 8MM	1	2

ATENÇÃO!!!! montadores e consumidores

* Ajustar o torque da parafusadeira para não danificar as peças escareando o parafuso *

ATENCIÓN!!!! montadores e consumidores

* Ajuste el torque del destornillador para no dañar las piezas avallanando el tornillo *

ATTENTION!!!! assemblers and consumers

* Adjust the torque of the screwdriver so as not to damage the parts by countersinking the screw

Ferramenta necessárias
Necessary tools
Herramientas necesarias

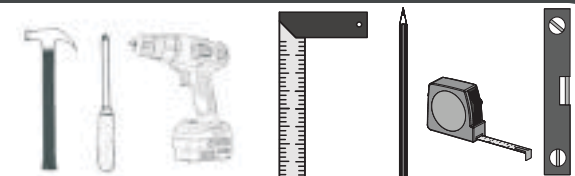

60 min.



2 montador
2 ajustador
2 Fitter

www.decibal.com.br

ATENÇÃO!!!! montadores e consumidores

* Para limpar o móveis utilize somente um pano úmido (umedecido em água pura ou água com sabão neutro). Depois, passe um pano seco. Evite a umidade excessiva.

* Evite usar álcool, água sanitária, detergente e outros produtos químicos, mesmo diluídos em água. Não utilize produtos abrasivos de nenhuma espécie

ATENCIÓN!!!! montadores e consumidores

* Para limpiar el mueble utilice solamente un paño húmedo (humedecido con agua limpia o con un jabón suave). A continuación, utilice un paño seco. Evite el exceso de humedad.

* Evite uso de alcohol, hipoclorídrico solución basada, detergente y otros productos químicos, mismo diluídos en agua. No utilice productos abrasivos de ningún tipo.

ATTENTION!!!! assemblers and consumers

* To clean the furniture, use only a damp cloth (humidify it only in pure water or water and neutral soap). After, use a dry cloth. Avoid excessive humidity. *Avoid using alcohol, bleach, detergent and other chemical products, even diluted in water. Do not use any kind of abrasive cleaning agents to clean the furniture.



The use of such products may jeopardize the final characteristics of the furniture.

AC4005 - KIT COZINHA









Manual de Montagem
Assembly Instructions
Instrucción de Montaje

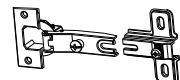

Escala (1:1)

LEGENDA	DESCRIÇÃO/DESCRIPCIÓN/DESCRIPTION	CÓDIGO	QUANT.
P7	 PARAFUSO/TORNILLO/SCREW 4X45	01318	22
Pr1	 PREGO/CLAVO/NAIL 10X10	01330	86
C2	 CAVILHA/TARUGO/DOWEL 6X30 MM	01211	23
B	BUCJA/BUJE/BUCHING 	02734	16
C3	 CAVILHA/TARUGO/DOWEL 6X50 MM	01212	04
P5	 PARAFUSO/TORNILLO/SCREW 4X25	01317	04
P12	 PARAFUSO/TORNILLO/SCREW 3,5X13	09927	64
P1	 PARAFUSO/TORNILLO/SCREW 3,5X12	01328	05

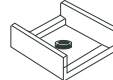
Escala (N/A)

LEGENDA	DESCRIÇÃO/DESCRIPCIÓN/DESCRIPTION	CÓDIGO	QUANT.
CL	 COLA/PEGAMENTO/GLUE	01213	01
Ct1	 CANTONEIRA/PIEZA L/SHEET	03077	16
DC	 DOBRADIÇA/BISAGRA/HINGE D=26mm C=12mm	01657	08
PX	 PUXADOR/PEGADOR/HANDLE	07388	04
ET	 ETIQUETA LOGO DECIBAL/LABEL DECIBAL	01312	01
FX	 FIXADOR COSTA/FIJADOR FONDO/FIXER COAST	01331	18
BT	BATENTE SILICONE/ TOPE DE SILICONA/ SILICONE STOPPER 	02924	04
Pe1	 PÉ/PATA/FOOT	01367	06
AD	 ADESIVO/ADHESIVO/ADHESIVE	15MM	16

Medida em mm

