

Quiditá

Essência da qualidade

Móveis Quiditá
Bento Gonçalves - RS
Rodovia BR-470 KM 202 - Cep 95710-000
Fone: 0xx (54) 3458-1001
www.quiditamoveis.com.br

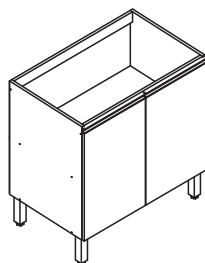

8005

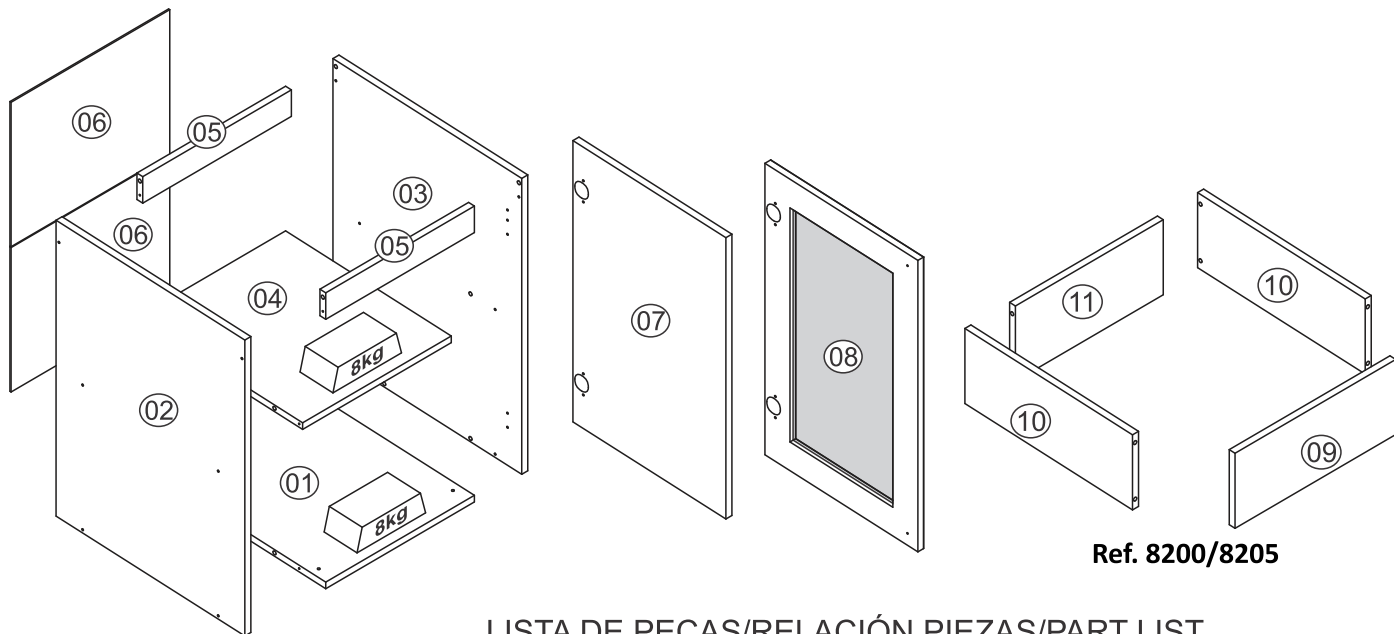

Ref. 8200/8205

LISTA DE PEÇAS/RELACIÓN PIEZAS/PART LIST

Ref. 8000/8200

| Nº | Código Code | Descrição/Descripción/Description | Dimensão (mm) Dimensiones (mm) Measures (mm) | Qtde. Cantidad Quantity |
|----|-------------|--|--|-------------------------------|
| 01 | 800001 | Base/Base/Base | 370 x 490 x 15 | 01 |
| 02 | 800003 | Lateral esquerda/Left side/L teral izquierda | 670 x 490 x 15 | 01 |
| 03 | 800002 | Lateral direita/Right side/Lateral derecha | 670 x 490 x 15 | 01 |
| 04 | 800004 | Prateleira/Repisa/Shelf | 370 x 430 x 15 | 01 |
| 05 | 800005 | Travessa/Traverse/Travessaño | 370 x 60 x 15 | 02 |
| 06 | 800006 | Costa/Revés/Back | 395 x 327 x 3 | 01 |
| 07 | 800008 | Porta/Puerta/Door (Ref. 8000) | 637 x 397 x 15 | 01 |
| 08 | Q01306 | Porta/Puerta/Door (Ref. 8200) | 660 x 397 x 15 | 01 |

Ref. 8005/8205

| Nº | Código Code | Descrição/Descripción/Description | Dimensão (mm) Dimensiones (mm) Measures (mm) | Qtde. Cantidad Quantity |
|----|-------------|--|--|-------------------------------|
| 01 | 800501 | Base/Base/Base | 770 x 490 x 15 | 01 |
| 02 | 800003 | Lateral esquerda/Left side/L teral izquierda | 670 x 490 x 15 | 01 |
| 03 | 800002 | Lateral direita/Right side/Lateral derecha | 670 x 490 x 15 | 01 |
| 04 | 800502 | Prateleira/Repisa/Shelf | 770 x 430 x 15 | 01 |
| 05 | 800503 | Travessa/Traverse/Travessaño | 770 x 60 x 15 | 02 |
| 06 | 800504 | Costa/Revés/Back | 395 x 327 x 3 | 01 |
| 07 | 800008 | Porta/Puerta/Door (Ref. 8005) | 637 x 397 x 15 | 02 |
| 08 | Q01306 | Porta/Puerta/Door (Ref. 8205) | 660x 397 x 15 | 02 |

Ref. 8205





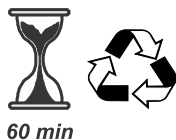
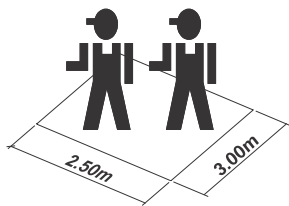



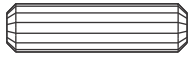

| | | | | |
|----|--------|---|----------------|----|
| 09 | 810502 | Rodapé frontal/Front baseboard/Zócalo delantero | 400 x 170 x 15 | 01 |
| 10 | 810501 | Rodapé lateral/Side baseboard/Zócalo lateral | 435 x 170 x 15 | 02 |
| 11 | 810503 | Rodapé traseiro/Back baseboard/Zócalo de atras | 368 x 170 x 15 | 01 |





FERRAMENTAS NECESSÁRIAS
HERRAMIENTAS NECESARIAS
NECESSARY TOOLS/





60 min

FERRAGENS/HERRAJES/HARDWARE

| | | | |
|---|--|---|--|
| A |  | Ø4,0x40mm | 12 |
| B |  | Cavilha/Tarugo/Dowel Ø8x30mm | 12 |
| C |  | Ø3,5x14mm | 40 |
| D |  | Ø3,0x25mm | 02 |
| E |  | Ø6,0x60mm | 04 |
| F |  | Ø5,0x50mm Ref. 8000/8005 | 04 |
| G |  | Prego/Clavo/Nail 10x10 | 28 |
| H |  | Bucha/Cojinete/Bush 8mm | 04 |
| I |  | | 04 |
| J |  | Garra metálica/Pieza fijación revés/ Back claw 13x13 | 05 |
| K |  | Sache cola/Pegamento/Glue | 01 |
| L |  | Dobradiça/Bisagra Hinge 35mm | Ref. 8000/8205 Ref. 8010/8210 02 04 |

| | | | |
|---|--|--|------------------------------------|
| M |  | Tapa furo/Tapa agujero/Hole sticker 12mm | 12 |
| N |  | Puxador perfil/Tirador/ Handle 397mm | Ref. 8000 Ref. 8005 01 02 |
| O |  | Puxador/Tirador/Handle | Ref. 8205 Ref. 8210 01 02 |
| Q |  | | 04 |

ROD400 - 8200/8205

| | | | |
|---|--|---------------------------------|----|
| B |  | Cavilha/Tarugo/Dowel Ø8x30mm | 08 |
| C |  | Ø3,5x14mm | 32 |
| P |  | | 16 |

1

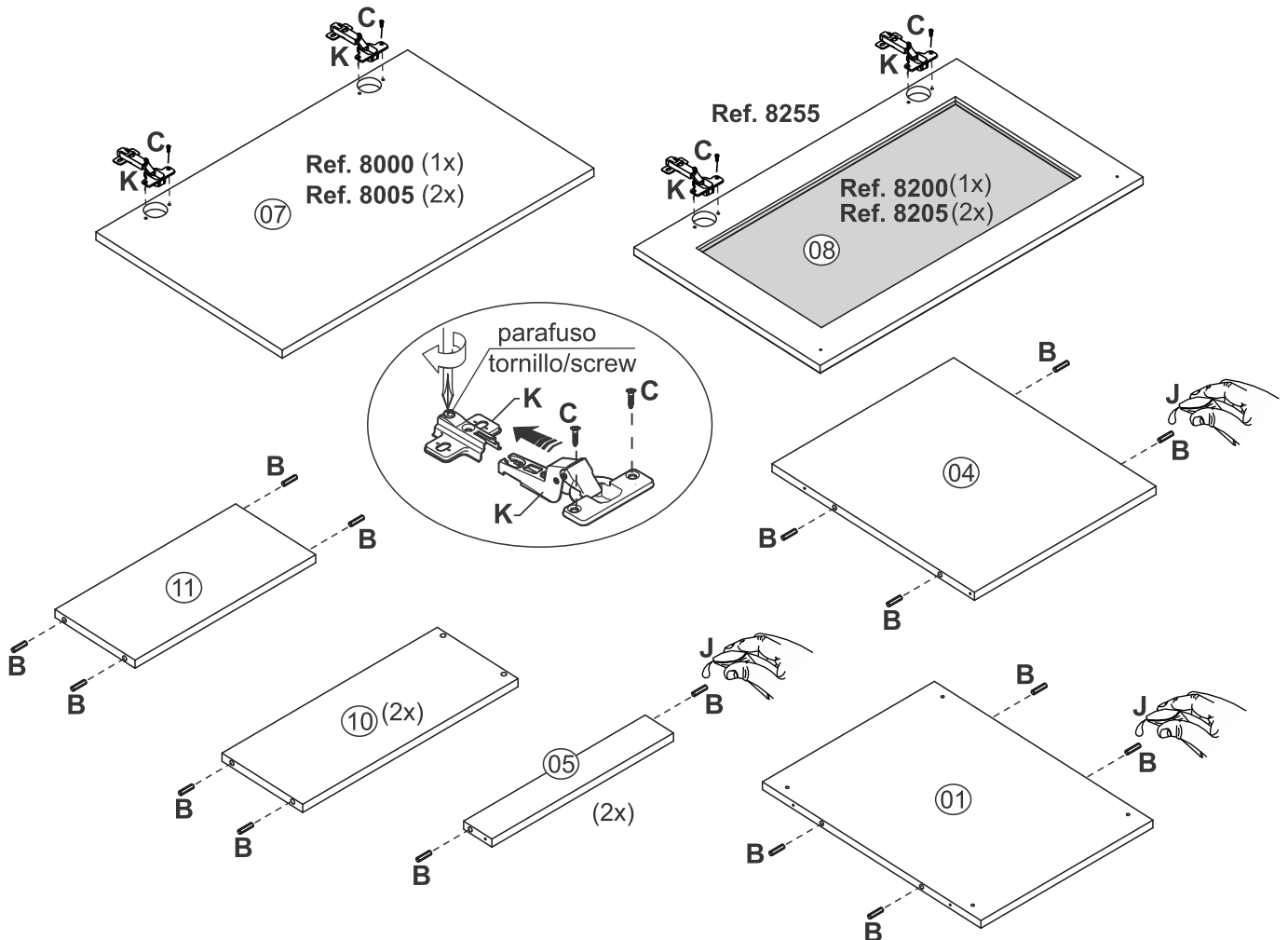

**2 Ref. 8000/8005
Ref. 8200/8205**

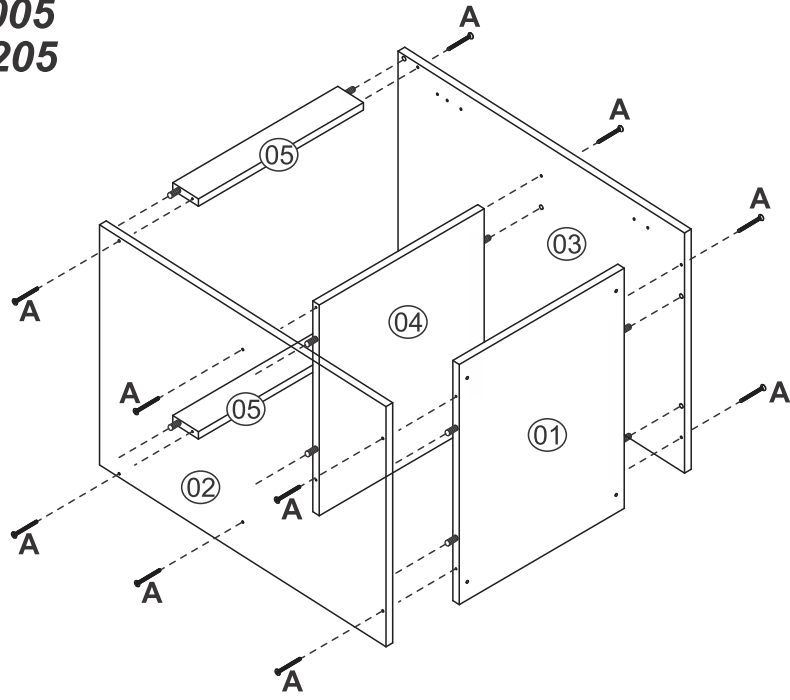

3 - Ref. 8000/8005

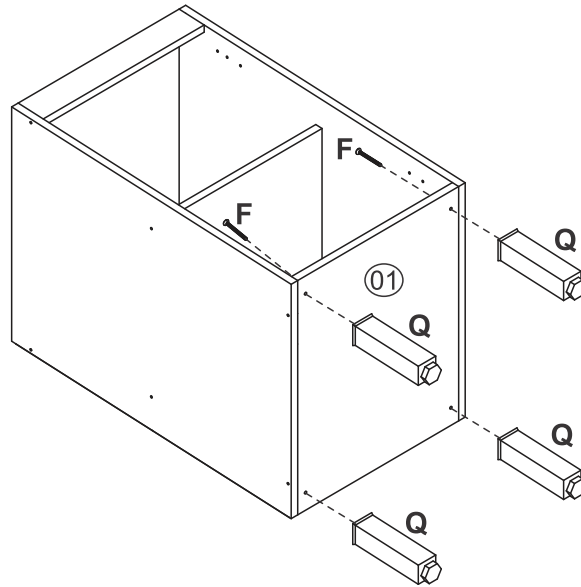

3 - Ref. 8200/8205

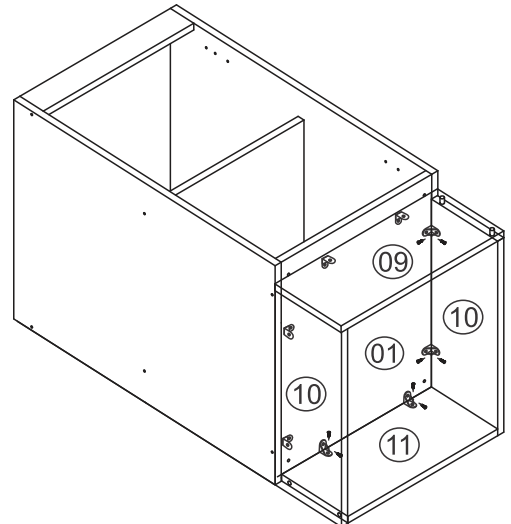
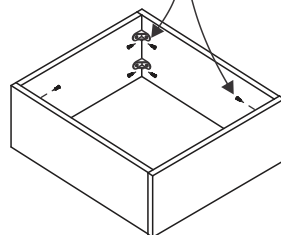
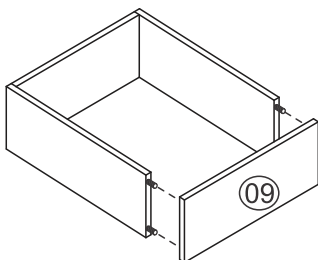
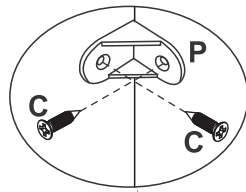
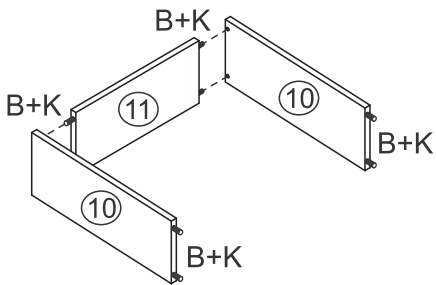

4

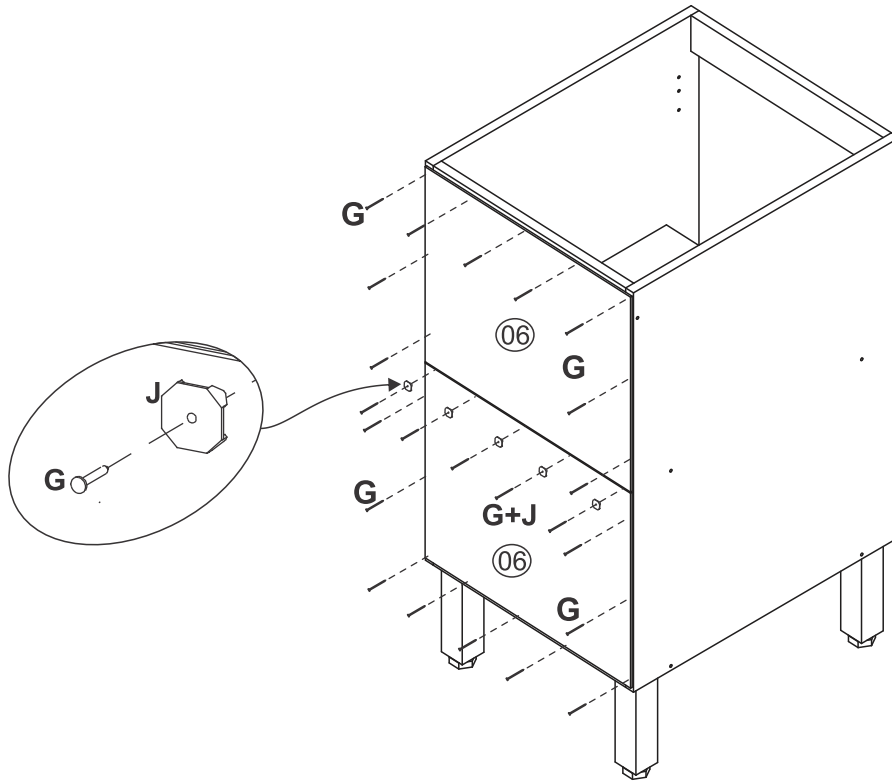

5 Fixação na parede - opcional
Fixing in the wall - optional
Fijación en pared - opcional

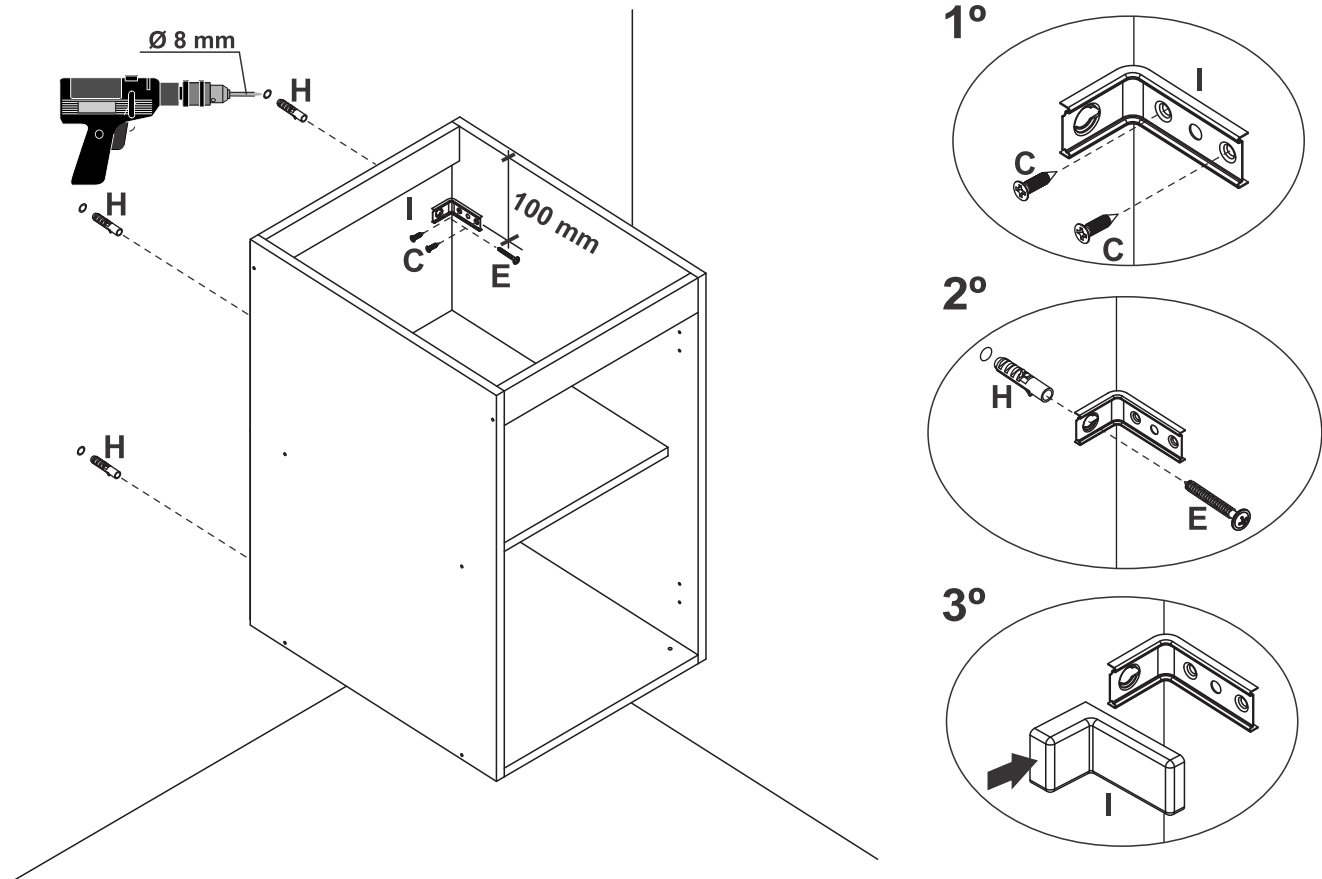

6 Posição de fixação do calço da dobradiça
 Hinge base fixing position
 Posición de fijación de la base de la bisagra

Ref. 8000/8005

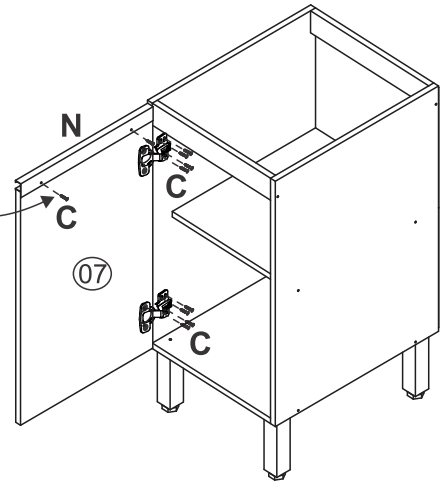
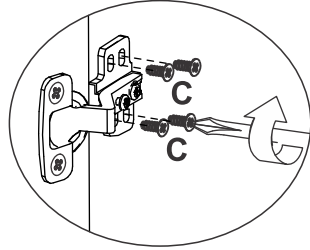
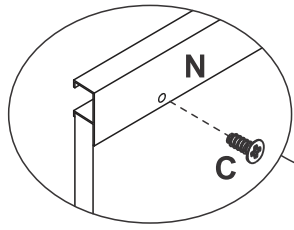
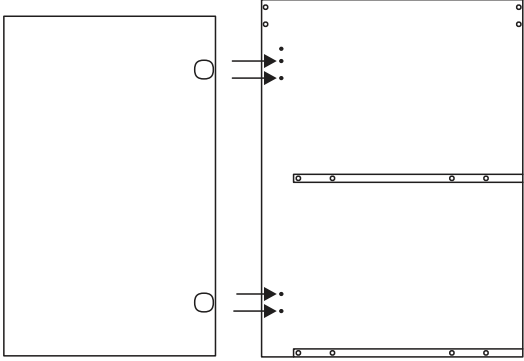

Ref. 8200/8205

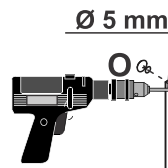
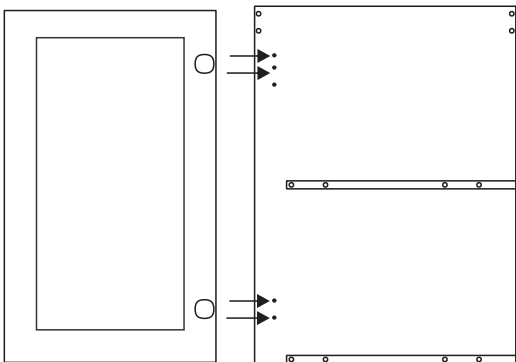

Ref. 8200/8205
 A porta pode ser
 direita ou esquerda.
 The door can be
 right or left.
 La puerta puede ser
 derecha o izquierda.

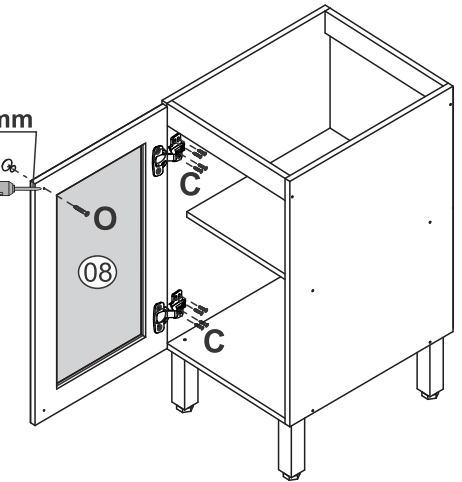

7

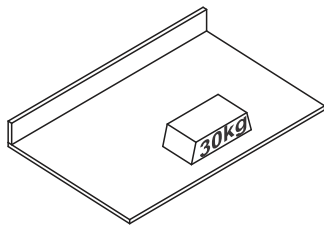
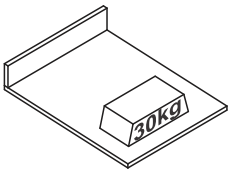





Ref. 8080

Ref. 8085

Tampos vendidos separadamente
 Tops sold separately
 Las tapas se venden por separado

FERRAGENS/HERRAJES/HARDWARE

| | | 8080 | 8085 |
|---|--|------|------|
| A |   Ø4,0x40mm | 02 | 03 |
| B |   Ø3,5x14mm | 08 | 16 |
| P |  | 04 | 08 |

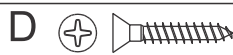

Ø3,0x25mm
 União de módulos
 Unión de módulos
 Union of modules

