

MANUAL DE MONTAGEM

ASSEMBLY INSTRUCTIONS / INSTRUCCIONES DE ARMADO

ARMÁRIO MULTIUSO LIMEIRA ALTO
 LIMEIRA high multiuse cabinet
 Armario multiuso LIMEIRA ALTO

Código **3265** | Revisão 14

Português
 English
 Español

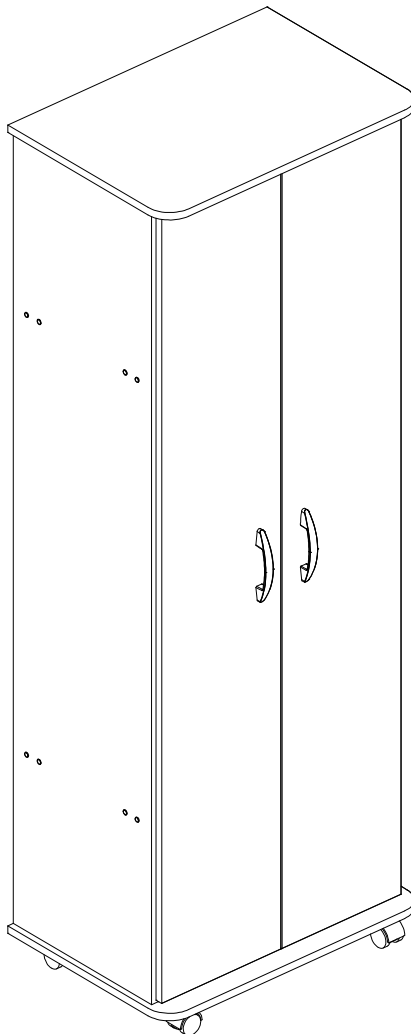

VOCÊ VAI PRECISAR DE / YOU WILL NEED / USTED NECESITARÁ

Ferramentas não fornecidas / Tools not supplied / Herramientas no incluidas

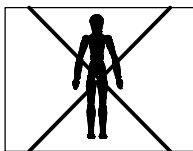

1 Pessoa
 1 Person
 1 Persona

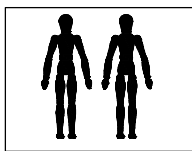

2 Pessoas
 2 People
 2 Personas

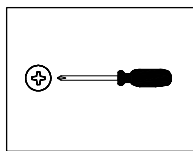

Chave Phillips
 Screwdriver Phillips
 Destornillador cruz

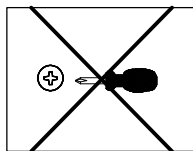

Chave Phillips Menor
 Small screwdriver Phillips
 Destornillador cruz menor

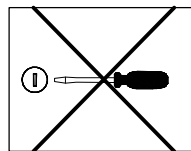

Chave fenda
 Screwdriver slotted
 Destornillador plano

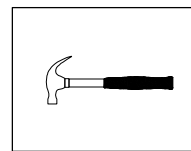

Martelo
 Hammer
 Martillo

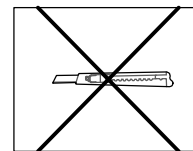

Estilete
 Stylet
 Estilete



Furadeira
 Drill machine
 Taladro

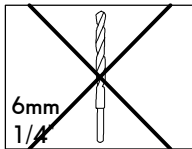

Broca
 Drill bit
 Taladro

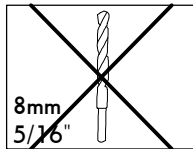

Broca
 Drill bit
 Taladro

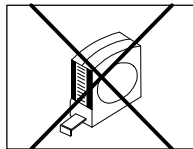

Trena
 Measuring tape
 Cinta de medición

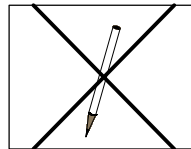







Lápis
 Pencil
 Lápiz

NOTAS: A separação dos acessórios antes de iniciar a montagem facilitará a mesma. Em caso de dúvida no tamanho dos parafusos e cavilhas, utilize a régua ao final da página 2.

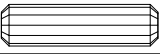
NOTES: The separation of the accessories before you start the assembly will facilitate the same. In case of doubt on the size of the screws and bolts, use the ruler to bottom of page 2.

NOTAS: La separación de los accesorios antes de comenzar el armado facilitará el mismo. En caso de duda sobre el tamaño de los tornillos y taquetes, utilice la regla al pie de página 2.

IDENTIFICAÇÃO DOS ACESSÓRIOS/ IDENTIFICATION OF ACCESSORIES/ IDENTIFICACIÓN DE ACCESORIOS

A6		Perfil "H" / "H" profile / Perfil "H"	-	1
C2		Puxador / Handle / Tirador	96 mm	2
D5		Calço dobradiça / Hinge shim / Bisagra de calce	-	6
E		Cavilha / Wooden dowel / Taquete	8x30 mm	16
E3		Suporte de prateleira / Shelf bracket / Suporte de repisa	8x7 mm	24
F6		Dobradiça curva / Metal hinge curve / Esquina de bisagra metálica	26 mm	6
G		Parafuso estrutural / Structural screw / Tornillo estructural	5,0x50 mm	8
H		Chave allen / Allen key / Liave allen	3 mm	1
H6A		Rodizio 40 / Caster / Rueda	-	4
I		Tampa parafuso estrutural / Structural screw cover / Tapa tornillo estructural	-	8
J		Haste minifix simples / Simple minifix screw / Tornillo minifix simple	-	4
L		Tambor minifix / Drum lock / Tambor minifix	12 mm	4
M		Tapa furo adesivo / Bore patch adhesive / Tapones adhesivo	-	4
N		Prego / Nail / Clavo	10 x10	46
O		Parafuso chato / Flat head screw / Tornillo de cabeza plana	4,5x45 mm	4
S		Parafuso panela / Pan head screw / Tornillo de pan	3,5x14 mm	40
T		Parafuso flangeado / Flanged head screw / Tornillo de cabeza flangeada	3,5x25 mm	4
Z		Tapa furo plástico / Plastic hole plugs / Tapones plásticos	8 mm	8



IDENTIFICAÇÃO DAS PEÇAS / PARTS IDENTIFICATION/ IDENTIFICACIÓN DE LAS PIEZAS

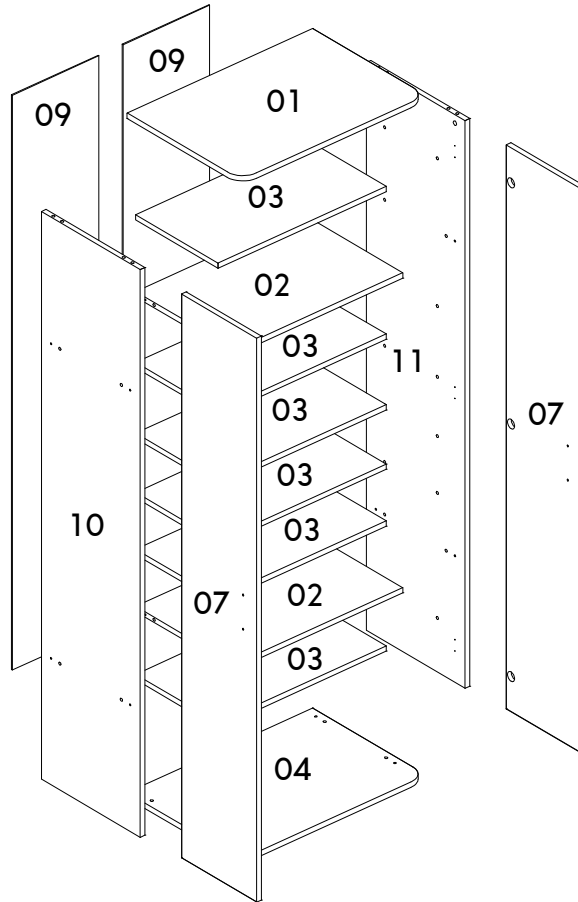

Número / Number / Número	Medidas / Measures / Medidas		Qtd. / Qty. / Qtd.
	cm	inches	
01	59,6 x 41,5 x 1,5	23" 1/2 x 16" 3/8 x 5/8	1
02	54 x 36 x 1,5	21" 1/4 x 14" 1/8 x 5/8	2
03	54 x 30 x 1,5	21" 1/4 x 11" 3/4 x 5/8	6
04	59,6 x 41,5 x 1,5	23" 1/2 x 16" 3/8 x 5/8	1
07	158,8 x 27,4 x 1,5	62" 1/2 x 10" 3/4 x 5/8	2
09	161,8 x 27,8 x 0,3	63" 3/4 x 11" x 1/8	2
10	159,8 x 36 x 1,5	62" 7/8 x 14" 1/8 x 5/8	1
11	159,8 x 36 x 1,5	62" 7/8 x 14" 1/8 x 5/8	1

01

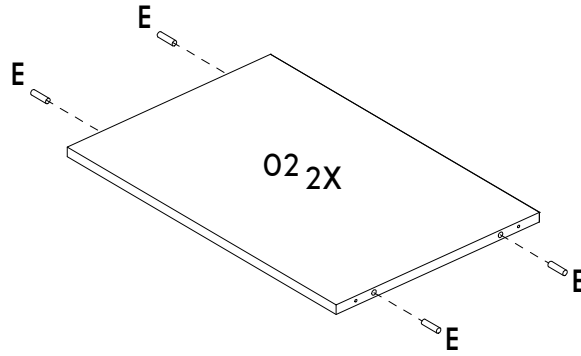
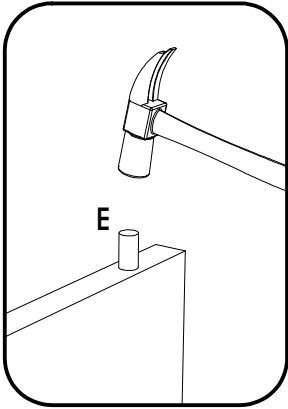

02

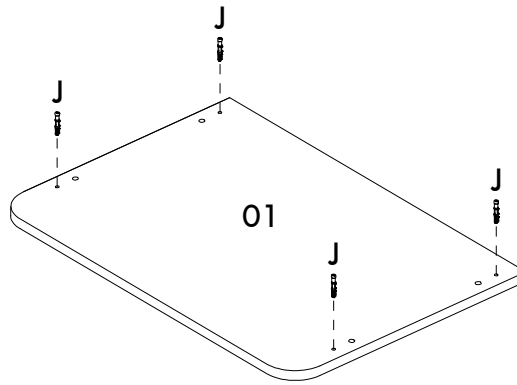
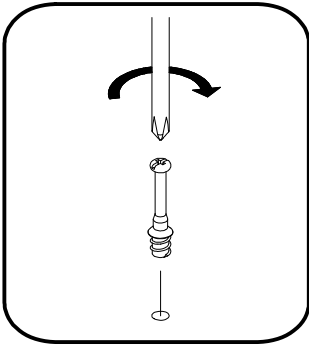

03

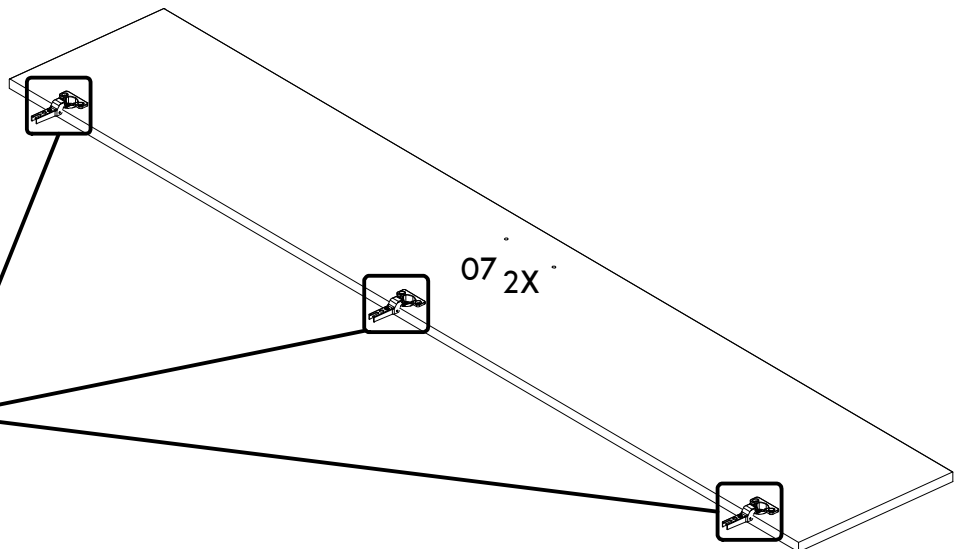
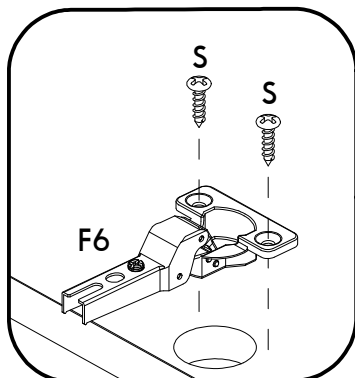

04

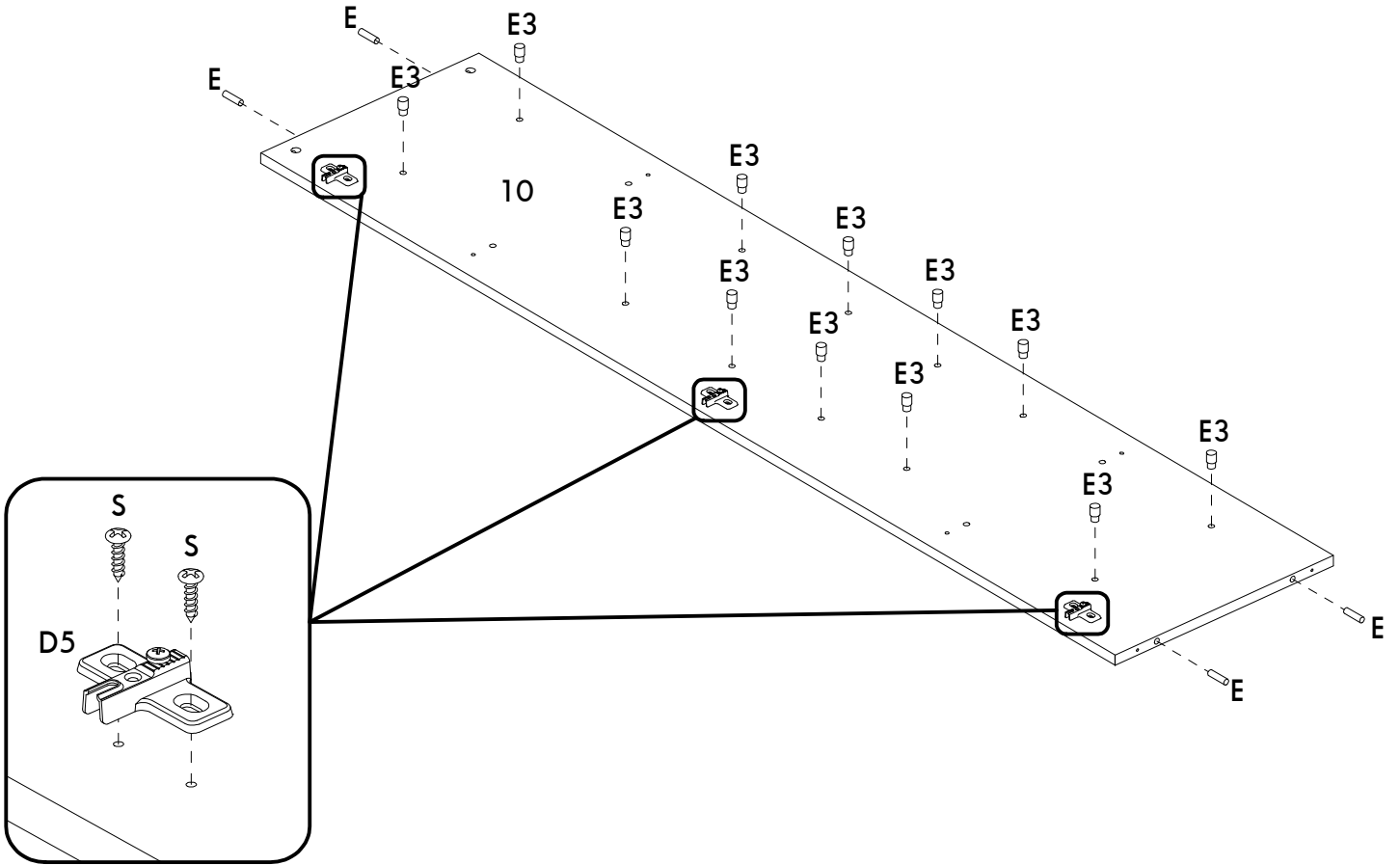

05

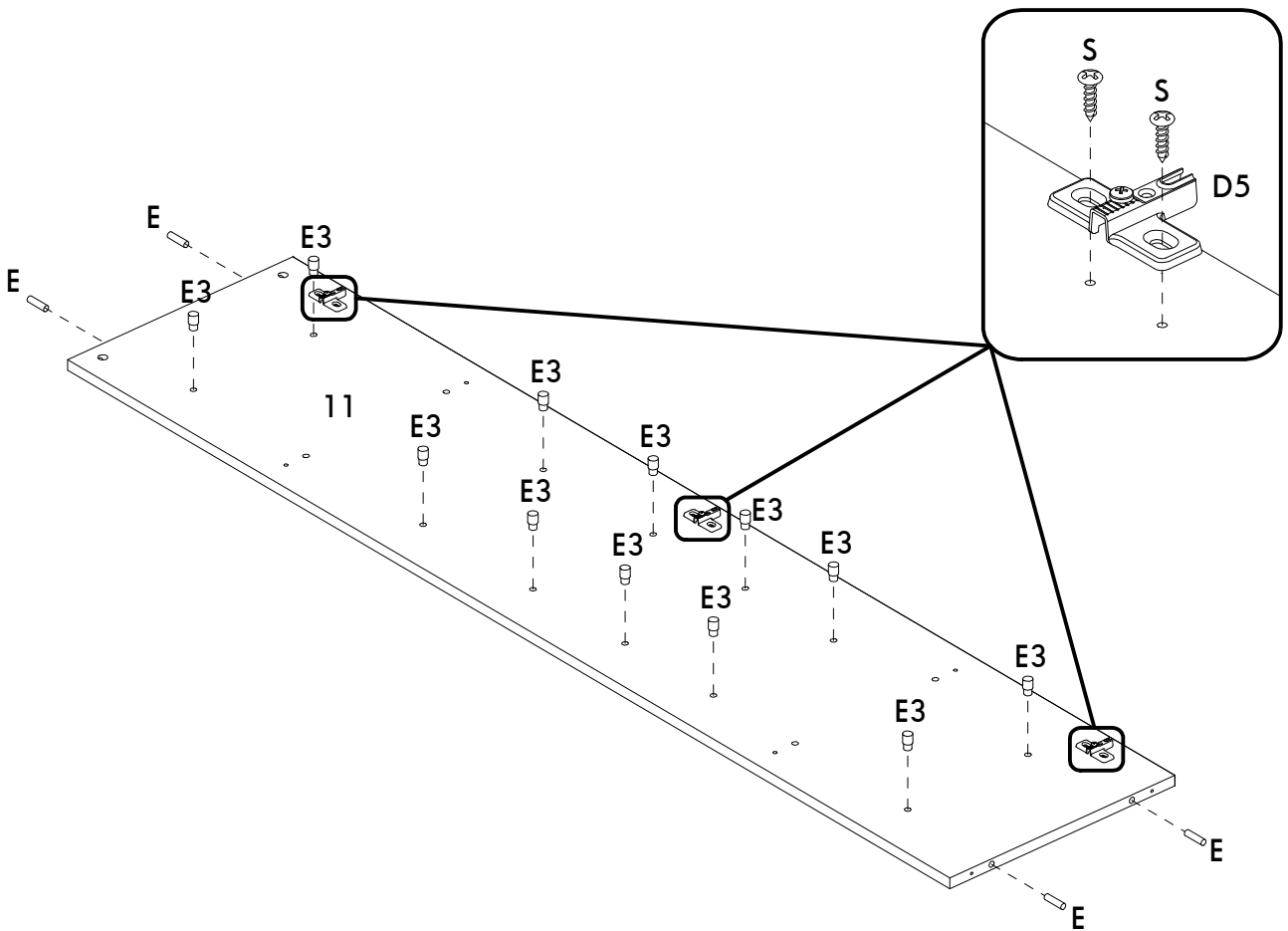

07

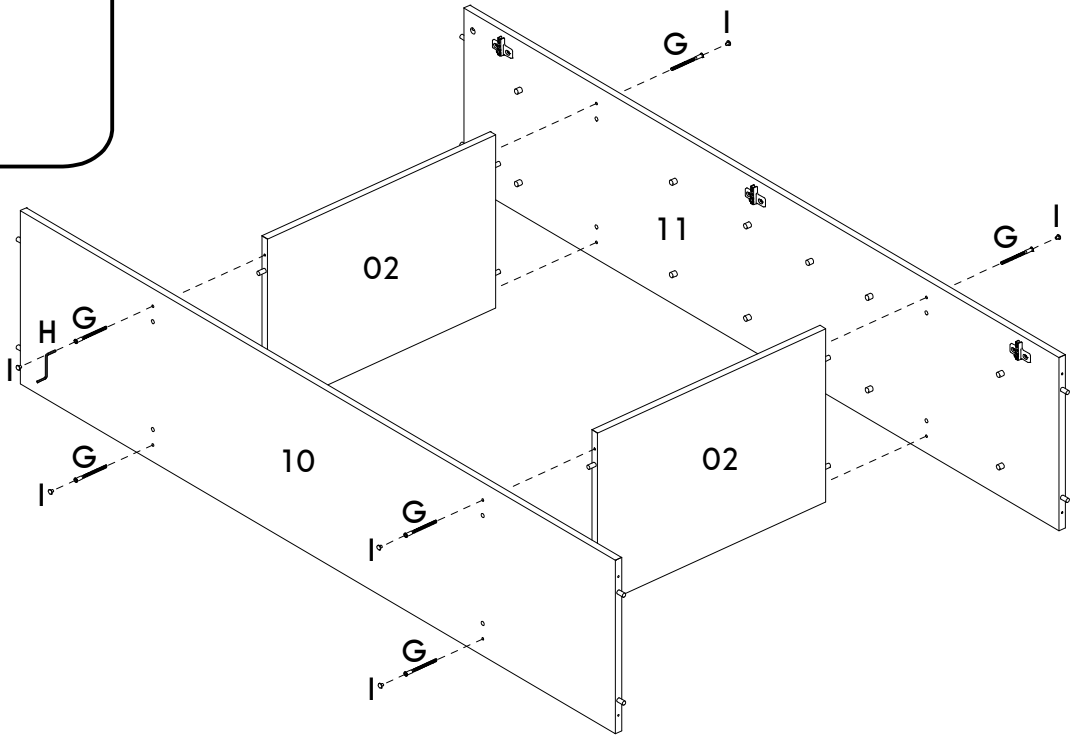
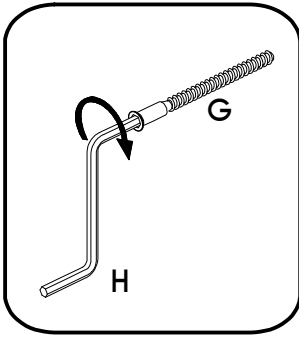

08

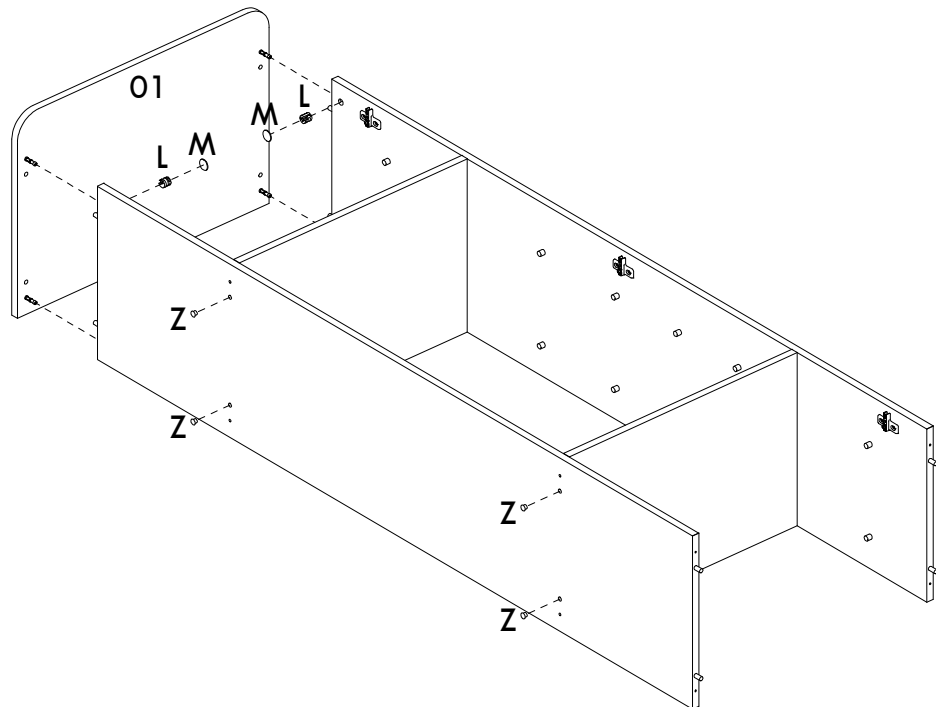
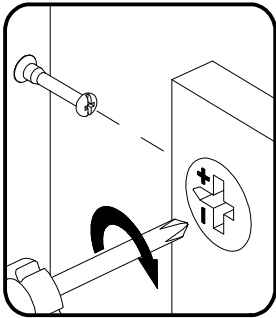

09

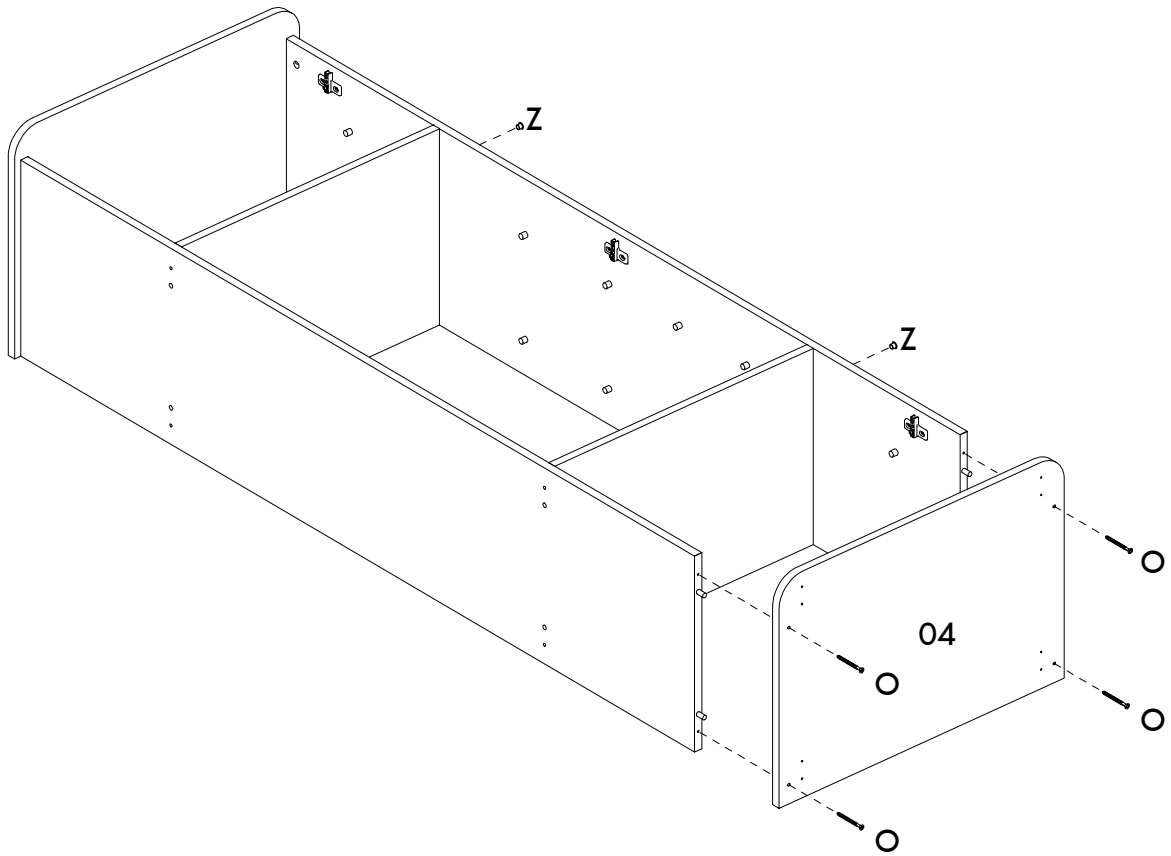

10

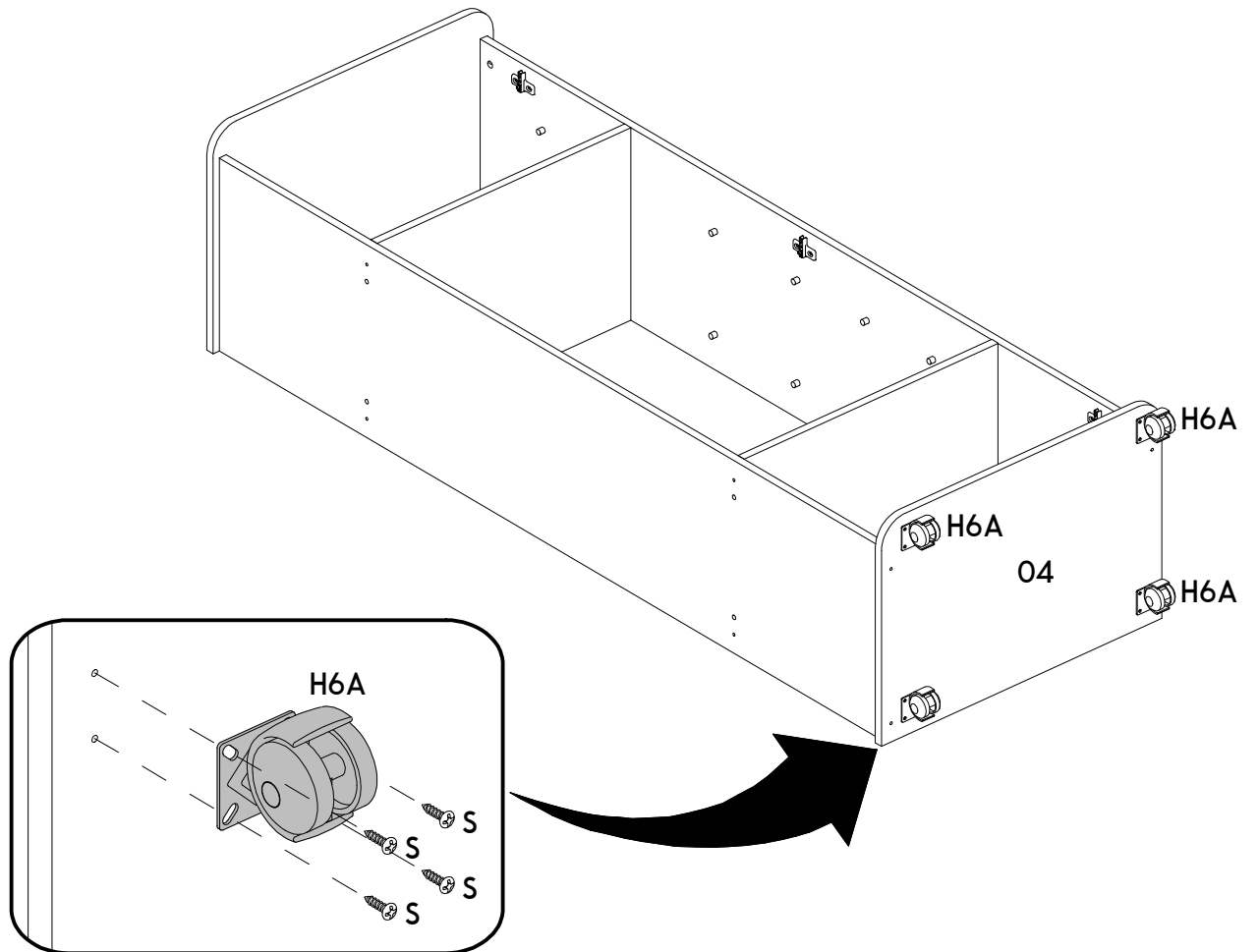

11

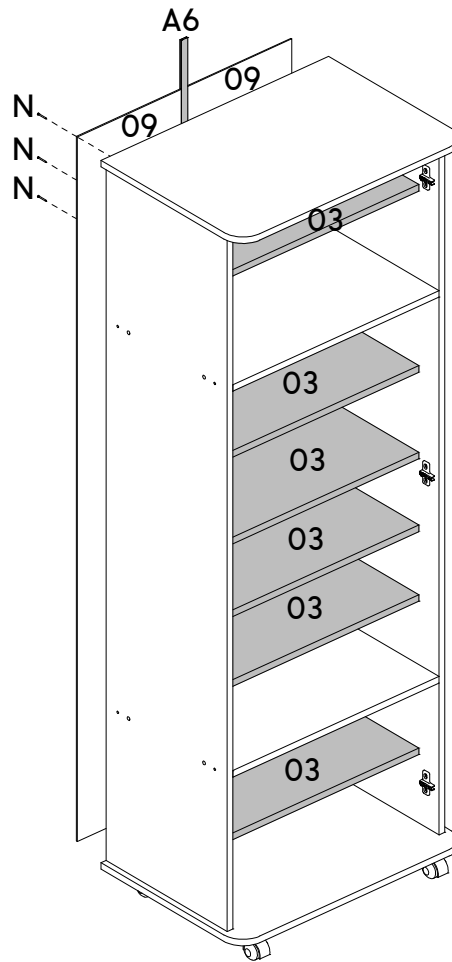

12

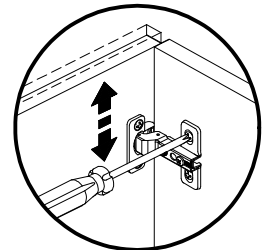
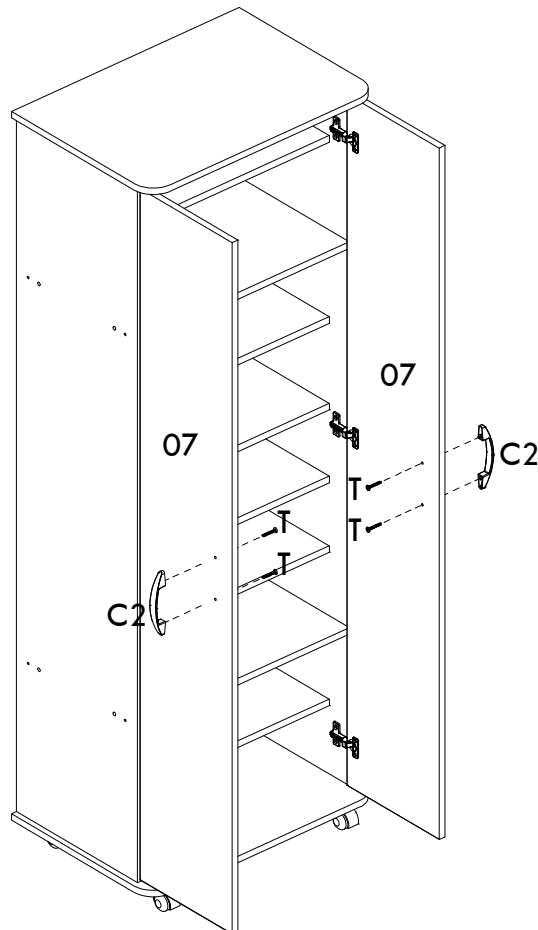

Regulagem Vertical
Ajuste Vertical
Vertical Adjustment

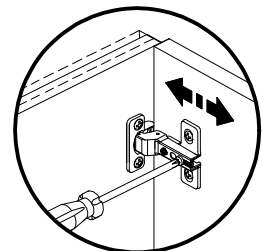

Regulagem Profundidade
Ajuste Profundidad
Depth Adjustment

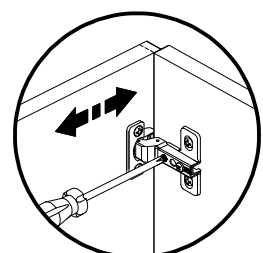

Regulagem Horizontal
Ajuste Horizontal
Horizontal Adjustment

13

PESO MÁXIMO RECOMENDADO SENDO ESTE DISTRIBUÍDO UNIFORMEMENTE
MAXIMUM RECOMMENDED WEIGHT BEING THIS EVENLY DISTRIBUTED / PESO MÁXIMO RECOMENDADO SIENDO ESTE UNIFORMEMENTE DISTRIBUIDO

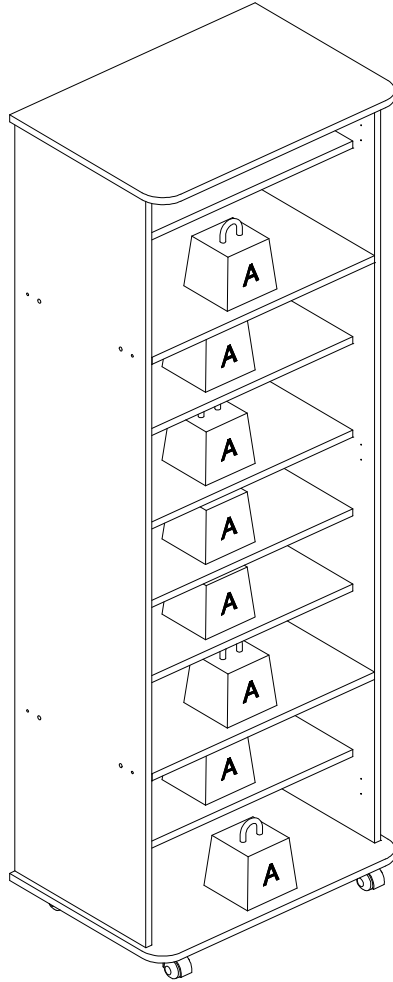

	KG	LB
A	7	15