

ARMÁRIO CLEAN - 2 PORTAS

Cabinet **Clean** - 2 doors
Armario **Clean** - 2 puertas

Código **3452** | Revisão 04

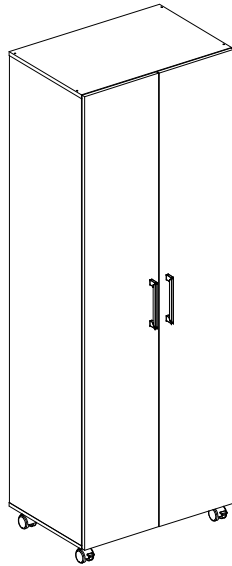

PESO MÁXIMO SUPORTADO PELAS PEÇAS, SENDO ESTE DISTRIBUÍDO UNIFORMEMENTE.

Maximum weight supported by parts, being this evenly distributed.
Peso máximo soportado por las partes, siendo esta distribuido uniformemente.

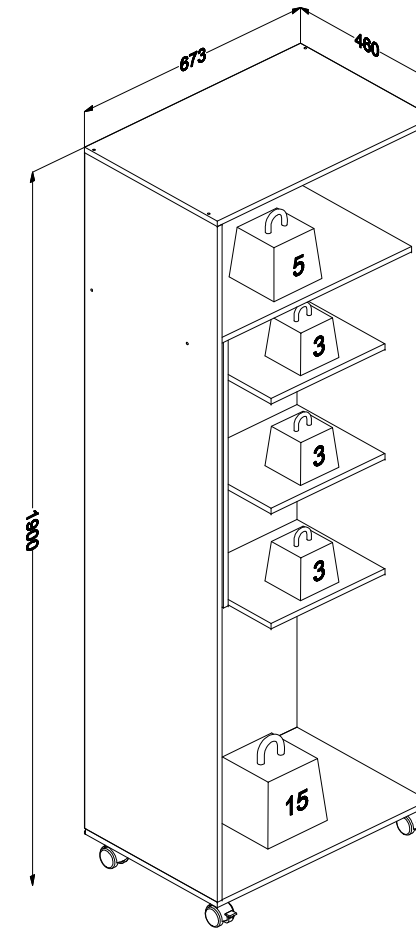

Você vai precisar de/ You will need / Usted necesitará

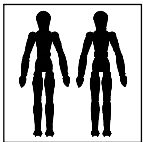

2 Pessoas
2 people
2 personas

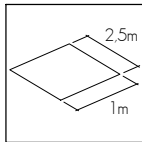

Espaço recomendado para montagem
Recommended space for assemble
Espacio recomendado para el armado

Ferramentas não inclusas Tools not included / Herramientas no incluidas

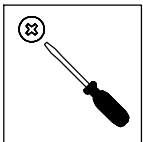

Chave Philips
Screwdriver
Destornillador cruz



Martelo
Hammer
Martillo

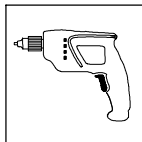

Furadeira
Drill machine
Taladro

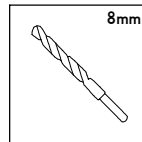

Broca
Drill bit
Taladro











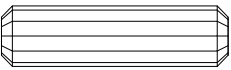

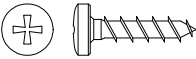
* PESO EM KG/ Weight in Kg/ Peso en Kg
DIMENSÕES EM MM/ Dimensions in mm/ Dimensiones en mm

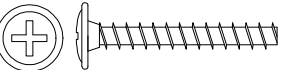
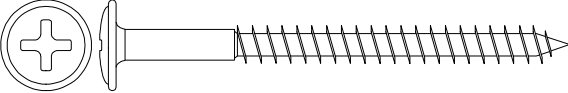
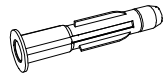
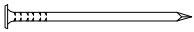
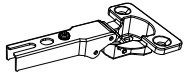
IDENTIFICAÇÃO DOS ACESSÓRIOS/ IDENTIFICATION OF ACCESSORIES/ IDENTIFICACIÓN DE ACCESORIOS

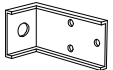
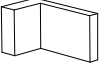
NOTAS: A separação dos acessórios antes de iniciar a montagem facilitará a mesma. Os parafusos e cavilhas estão na escala real. Em caso de dúvida na identificação, coloque o acessório sobre a imagem.

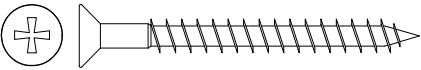
NOTES: The separation of the accessories before you start the assembly will facilitate the same. The screws and dowels are in real scale. In case of doubts about the identification, place the accessory on the image.

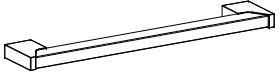
NOTAS: La separación de los accesorios antes de comenzar el armado facilitará el mismo. Los tornillos y taquetes son en escala real. En caso de dudas sobre la identificación, coloque el accesorio en la imagen.

| | | | | | | | | | |
|----|---|---|-----------|----|----|---|--|---|----|
| D |  | Cavilha Wooden Dowel Pin | 8x30 mm | 26 | 13 |  | Rodízio Caster Ruedas | - | 02 |
| E |  | Parafuso panela Pan head screw Tornillo de pan | 3,5x14 mm | 42 | 14 |  | Rodízio com trava Caster with lock Ruedas con bloqueo | - | 02 |
| F |  | Parafuso flangeado Flanged head screw Tornillo de cabeza flangeada | 3,5x25 mm | 04 | | | | | |
| G |  | Parafuso flangeado Flanged head screw Tornillo de cabeza flangeada | 5,0x60 mm | 04 | | | | | |
| H |  | Bucha expansiva Bushing Tapón | 8x50 mm | 04 | | | | | |
| I |  | Prego Nail Clavo | 10 x10 | 50 | | | | | |
| J |  | Dobradiça reta Straight hinge Bisagra recta | 26 mm | 06 | | | | | |
| K |  | Calço dobradiça Hinge shim Bisagra de calce | 5 mm | 06 | | | | | |
| L |  | Suporte "L" Support "L" Soporte "L" | - | 04 | | | | | |
| M |  | Capa Cover Cubierta | - | 04 | | | | | |
| Q |  | Tapa furo adesivo Bore patch adhesive Tapones ashesivo | - | 10 | | | | | |
| R |  | Parafuso chato Flat head screw Tornillo de cabeza plana | 4,5x45 mm | 19 | | | | | |
| 10 |  | Perfil "H" Profile "H" Perfil "H" | 1805 mm | 01 | | | | | |
| 11 |  | Puxador Handle Tirador | 160 mm | 02 | | | | | |
| 12 |  | Suporte Aramado Support Soporte | - | 01 | | | | | |

IDENTIFICAÇÃO DAS PEÇAS/ PARTS IDENTIFICATION/ IDENTIFICACIÓN DE LAS PIEZAS

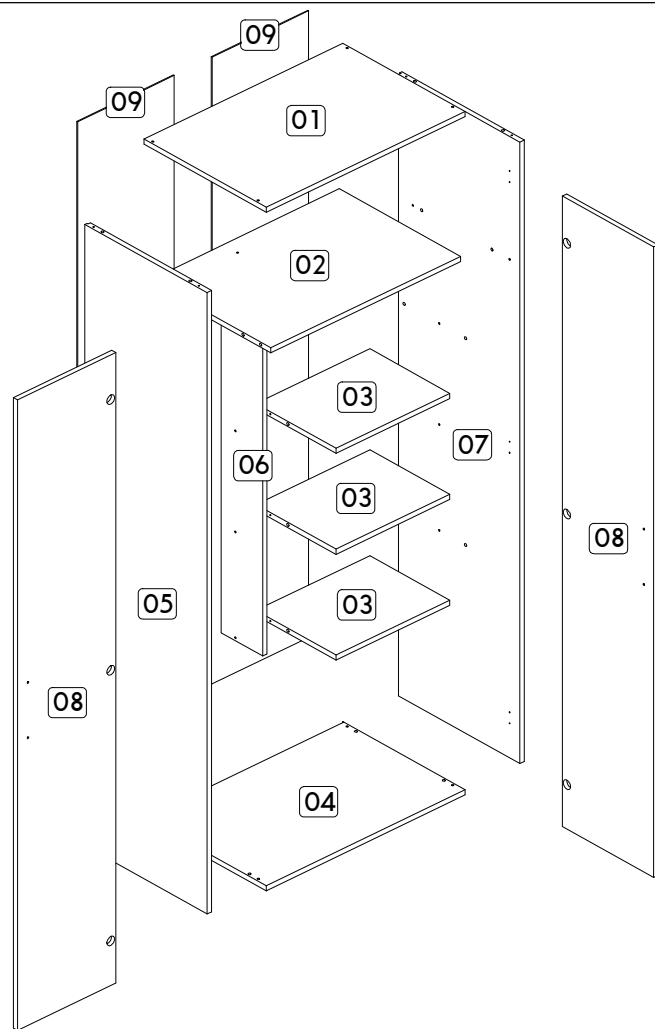

| Nº | DESCRIÇÃO - DESCRIPTION - DESCRIPCIÓN | MEDIDAS-MEASURES - MEDIDAS (mm) | QTD. |
|----|--|------------------------------------|------|
| 01 | Base superior - Top base - Base superior | 673 x 445 x 15 | 01 |
| 02 | Prateleira maior - Bigger shelf - Repisa mayor | 642 x 384 x 15 | 01 |
| 03 | Prateleira menor - Smaller shelf - Repisa menor | 354 x 295 x 15 | 03 |
| 04 | Base inferior - Bottom base - Base inferior | 673 x 445 x 15 | 01 |
| 05 | Lateral esquerda - Left side - Lateral izquierda | 1800 x 445 x 15 | 01 |
| 06 | Divisão - Division - División | 900 x 151 x 15 | 01 |
| 07 | Lateral direita - Right side - Lateral derecha | 1800 x 445 x 15 | 01 |
| 08 | Porta - Door - Puerta | 1826 x 332 x 15 | 02 |
| 09 | Costa - Back - Fondo | 1815 x 325 x 3 | 02 |

PRÉ-MONTAGEM/ PRE-ASSEMBLE/ PRE ARMADO

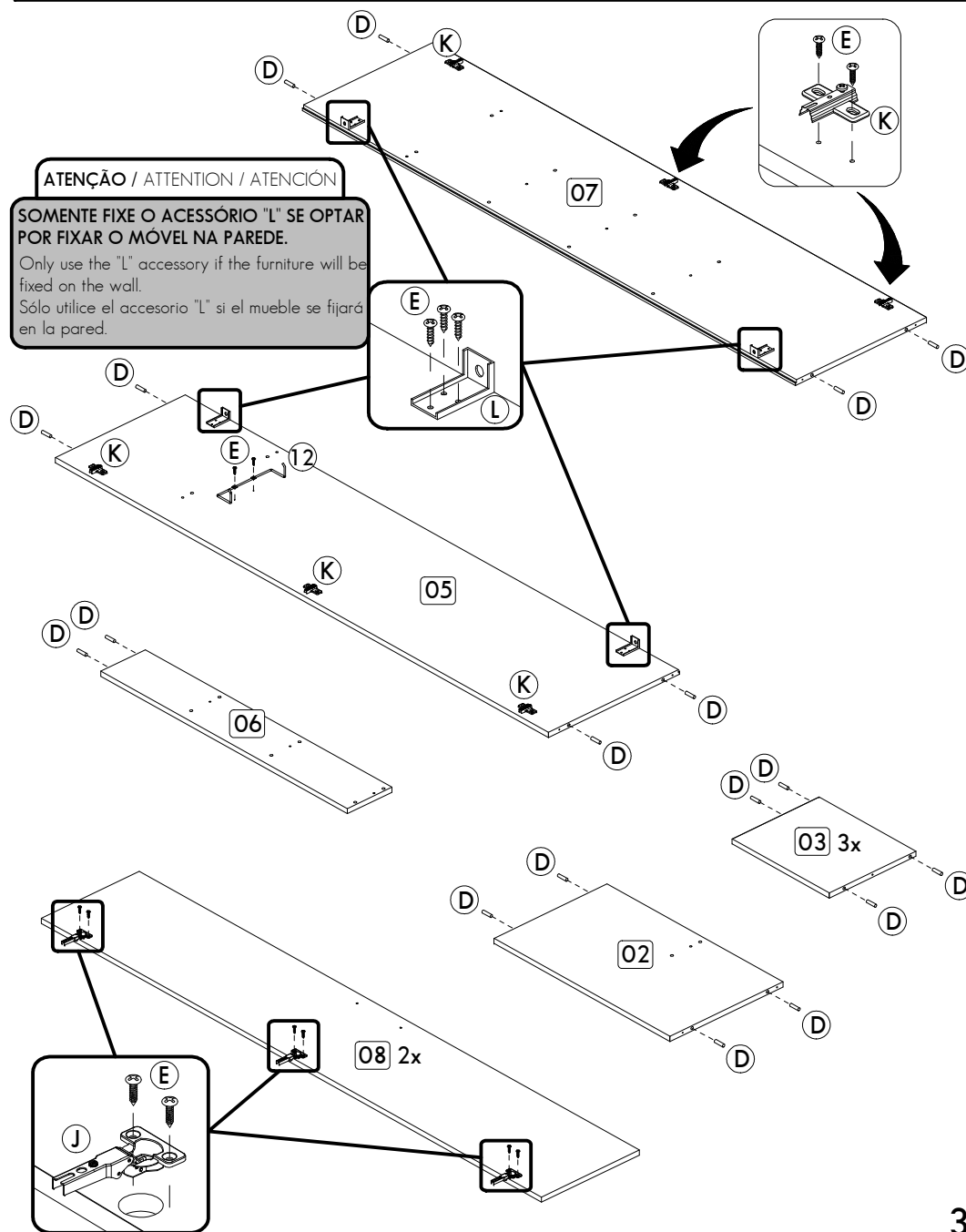

Passo/ Step/ Paso 01

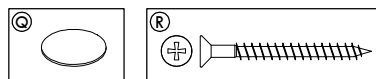
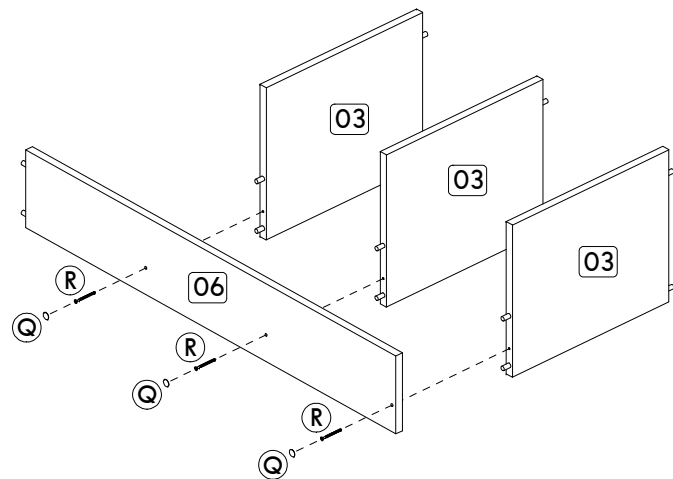

Passo/ Step/ Paso 02

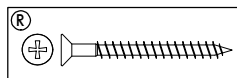
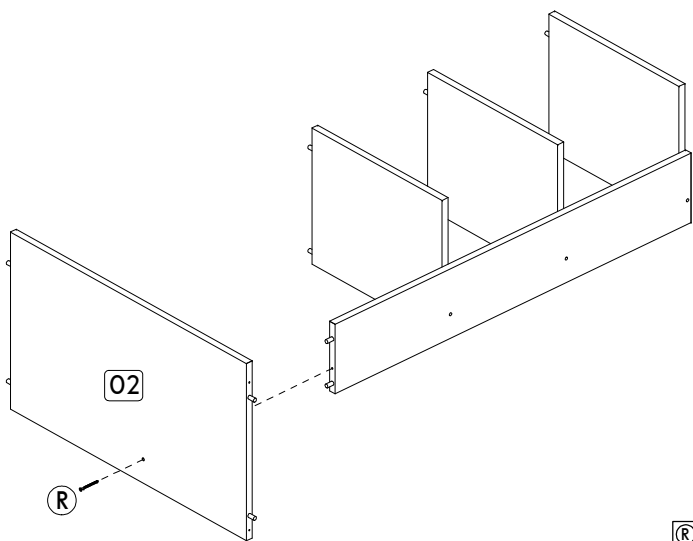

Passo/ Step/ Paso 03

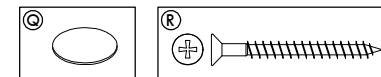
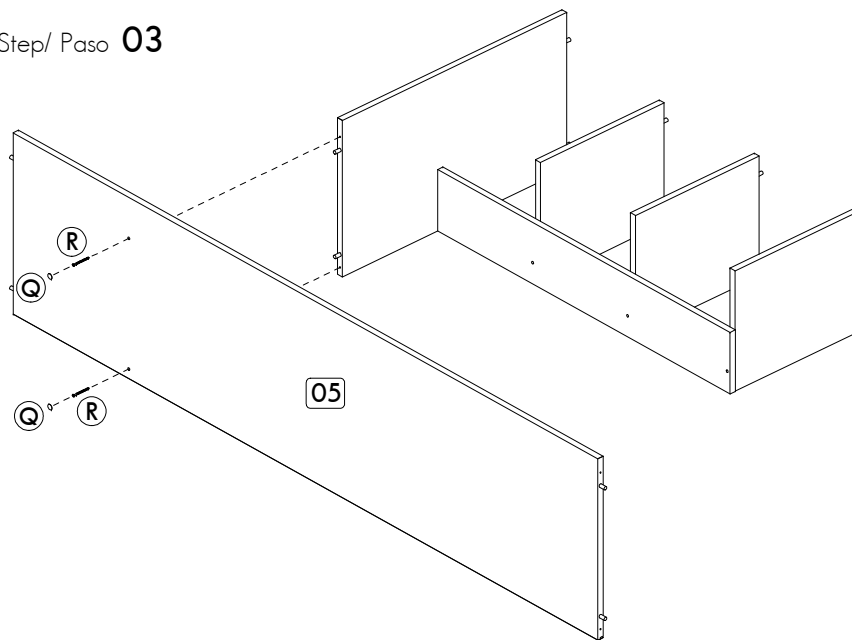

Passo/ Step/ Paso 04

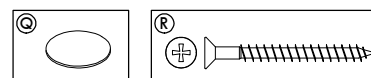
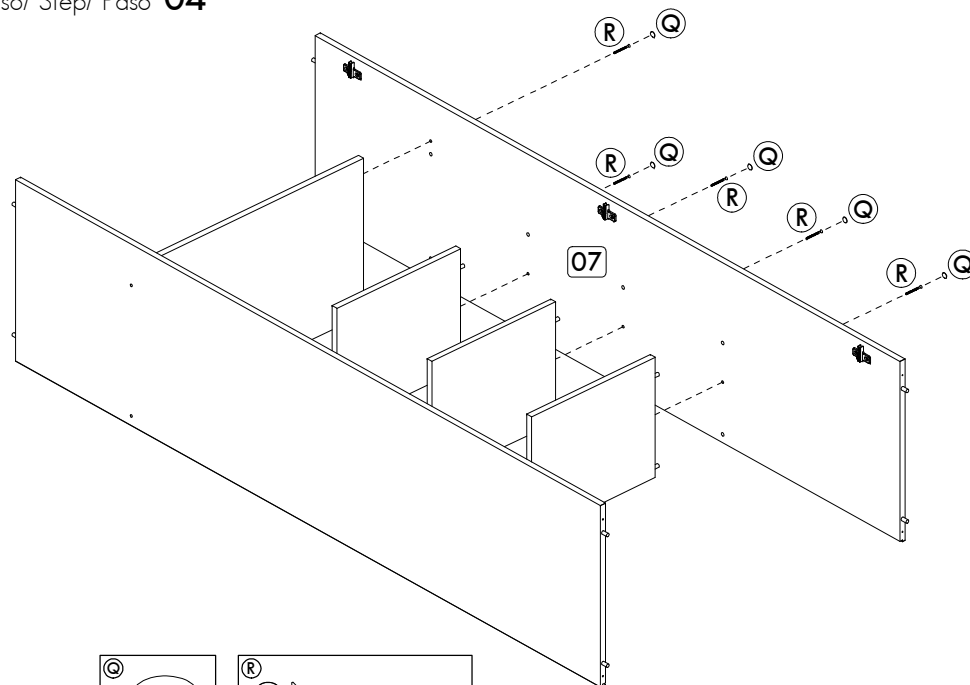

Passo/ Step/ Paso 05

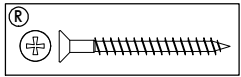
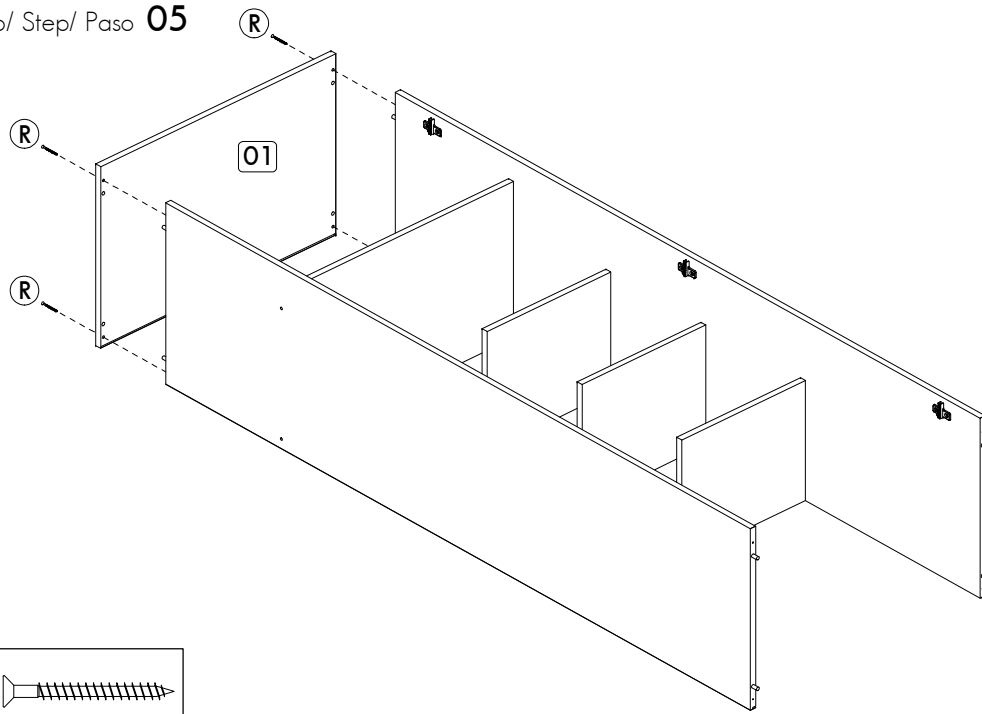

Passo/ Step/ Paso 06

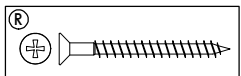
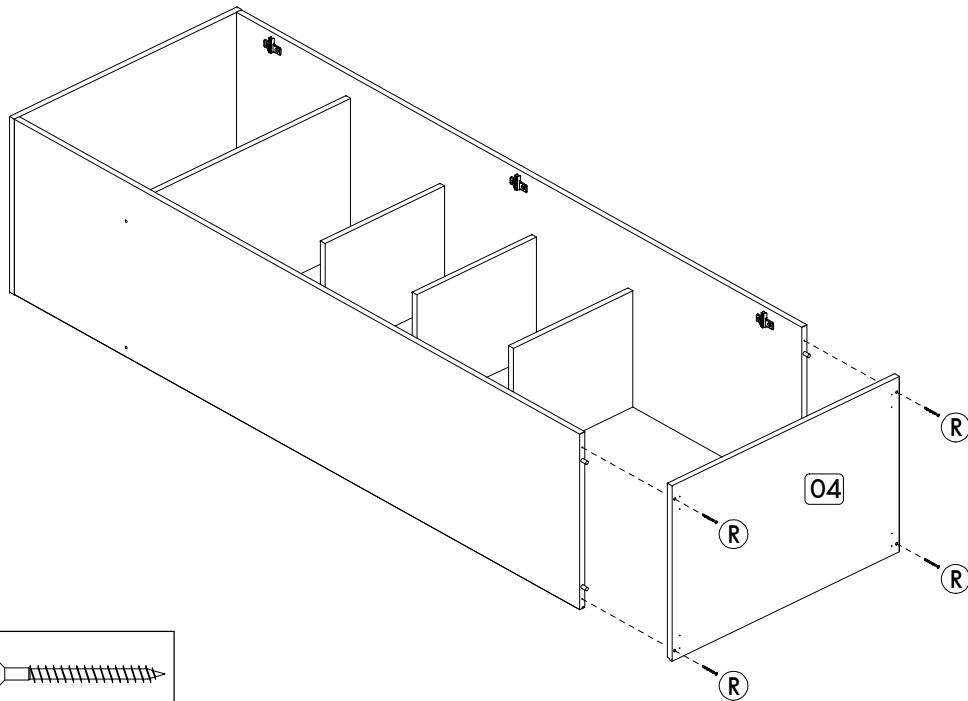

Passo/ Step/ Paso 07

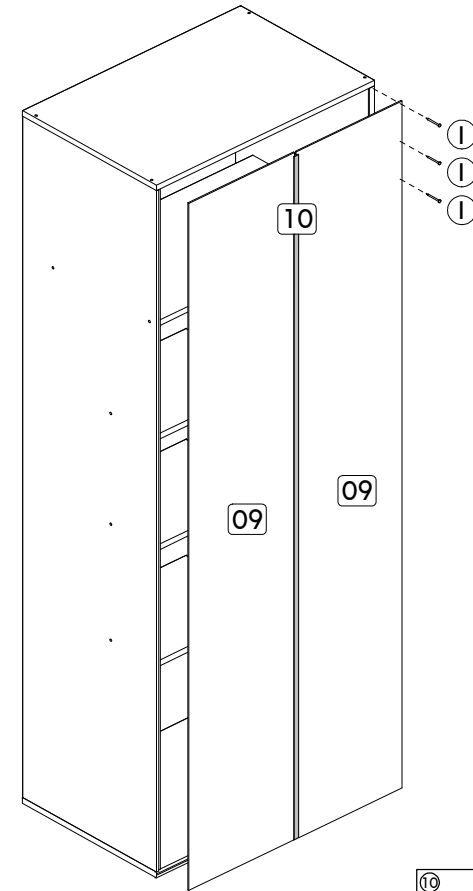

ATENÇÃO / Attention / Atención

SE VOCÊ OPTOU EM FIXAR O MÓVEL NA PAREDE, SIGA O PASSO 08. CASO CONTRÁRIO SIGA O PASSO 09.

SI EL MUEBLE SE FIJA EN LA PARED, SIGA EL PASO 08, SI NO, IR AL PASO 09.
IF THE FURNITURE WILL BE FIXED ON THE WALL, PLEASE FOLLOW THE STEP 08, IF DONT, GO TO STEP 09.

Passo/ Step/ Paso 08

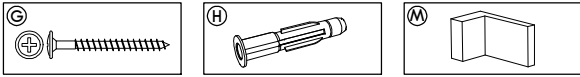
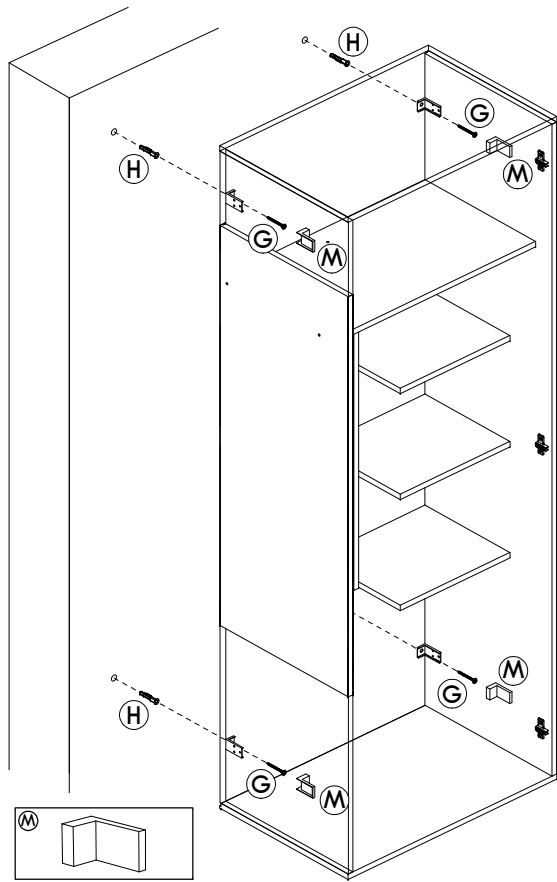

Passo/ Step/ Paso 09

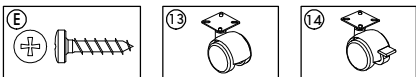
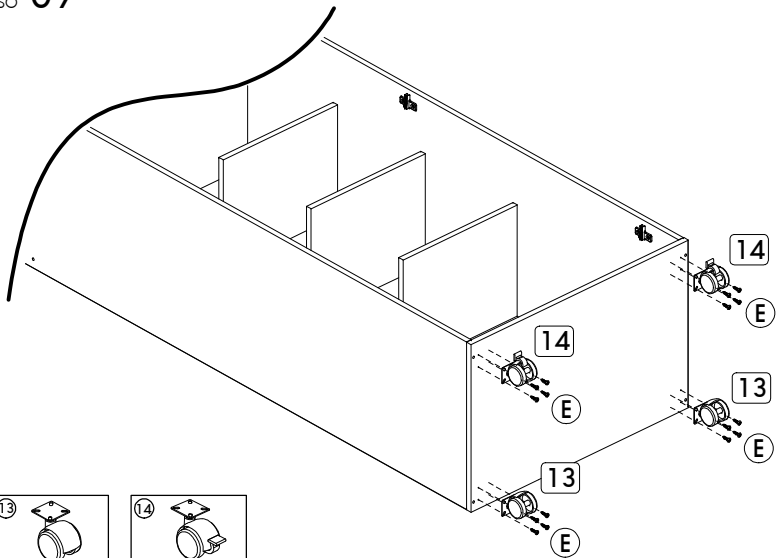

Passo/ Step/ Paso 10

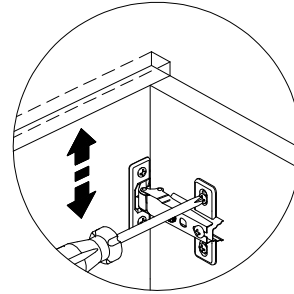

Regulagem Vertical
Vertical Adjustment
Ajuste Vertical

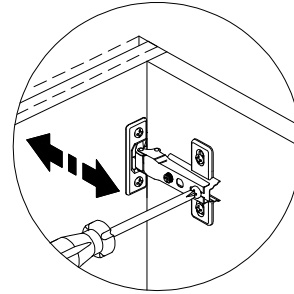

Regulagem Profundidade
Depth Adjustment
Ajuste Profundidad

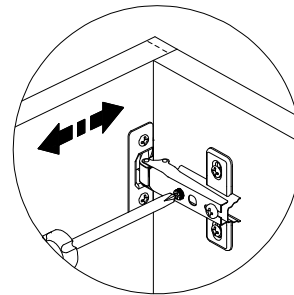

Regulagem Horizontal
Horizontal Adjustment
Ajuste Horizontal

