



JCM
movelaria

Multiuso Mucuri

Mucuri Mult-Use Cabinet

Armario Multiuso Mucuri



Indicamos que a montagem dos produtos seja realizada com parafusadeira eléctrica e por um montador profissional.

We recommend that the product assembly be performed with a cordless screwdriver and by a professional furniture assembler.

Se recomienda que el montaje de los productos sea realizado con un destornillador eléctrico y por un montador de muebles profesional.









AVISO: Não nos comprometemos pelo mal-uso, montagem e fixação do produto à parede. Portanto, não somos responsáveis por danos e quedas do produto, eletrônicos e pertences neles contidos. É importante o uso de brocas e ferramentas compatíveis na montagem.
 ATENTION: We are not responsible for misuse, assembly and wall fixation. Therefore, we are not responsible for damages and falls caused to the product, electronics and belongings therein. It is important to use suitable drills and tools for the assembly.
 ATENCIÓN: No nos responsabilizamos del mal uso, montaje y fijación del producto a la pared. Por lo tanto, no somos responsables de daños y caídas del producto, electrónicos y objetos que contiene. Es importante el uso de taladros y herramientas compatibles con el montaje.

Dica: Para evitar possíveis avarias, use a embalagem do produto como apoio durante a montagem.

Tip: To avoid damages, use the product packaging as base during the assembly.

Pista: Para evitar daños, use el envase del producto como apoyo durante el montaje.

RELAÇÃO DE FERRAGENS | HARDWARE LIST | LISTADO DE HERRAJES

BATENTE 2 FUROS	(A)	2-HOLE STOP	(A)	DETENDER 2 AGUJEROS	(A)		01
CALÇO DOBRADICA 5mm	(B)	5mm MOUNTING PLATE	(B)	BASE BISABRA 5mm	(B)		06
CANTONEIRA 04 FUROS	(C)	4-HOLE ANGLE BRACKET	(C)	ÁNGULO REFUERZO 4 AGUJEROS	(C)		03
CAVILHA 6x30 / 6x30 DOWEL	(D)	6x30 DOWEL	(D)	CLAVIJA 6x30	(D)		04
DOBRADICA RETA 26mm	(E)	26mm STRAIGHT HINGE	(E)	BISAGRA RECTA 26mm	(E)		06
KIT FECHADURA C/ CHAVE	(F)	LOCK AND KEY KIT	(F)	KIT DE CERRADURA Y LLAVE	(F)		01
PARAFUSO CHP CHA BC 3,5x12	(G)	3.5x12 SCREW	(G)	TORNILLO 3.5x12	(G)		46
PARAFUSO CHP FLA BC 3,5x14	(H)	3.5x14 SCREW	(H)	TORNILLO 3.5x14	(H)		08
PARAFUSO CHP FLA BC 3,5x30	(I)	3.5x30 SCREW	(I)	TORNILLO 3.5x30	(I)		04
PARAFUSO ESTR CHA PHI ZP 5x40	(J)	5x40 SCREW	(J)	TORNILLO 5x40	(J)		20
PINO SUPORTE PRATELEIRA 6x8	(K)	6x8 SHELF SUPPORT	(K)	SOPORTE ESTANTE 6x8	(K)		12
PREGO 8x8 C/C	(L)	8x8 NAIL	(L)	CLAVO 8x8	(L)		35
PUXADOR MULTIUSO 128mm	(M)	128mm HANDLE	(M)	TIRADOR 128mm	(M)		02
TRINCO METÁLICO	(N)	METALLIC LATCH	(N)	PESTILLO METÁLICO	(N)		01
PÉ	(O)	FOOT	(O)	PATA	(O)		04
PARAFUSO 3,5x12 FLANGEADO	(P)	3.5x12 FLANGED SCREW	(P)	TORNILLO 3,5x12 FLANGEADO	(P)		16
PARAFUSO 4x20	(Q)	4x20 SCREW	(Q)	TORNILLO 4x20	(Q)		02

RELAÇÃO DE PEÇAS | PARTS LIST | LISTADO DE PARTES

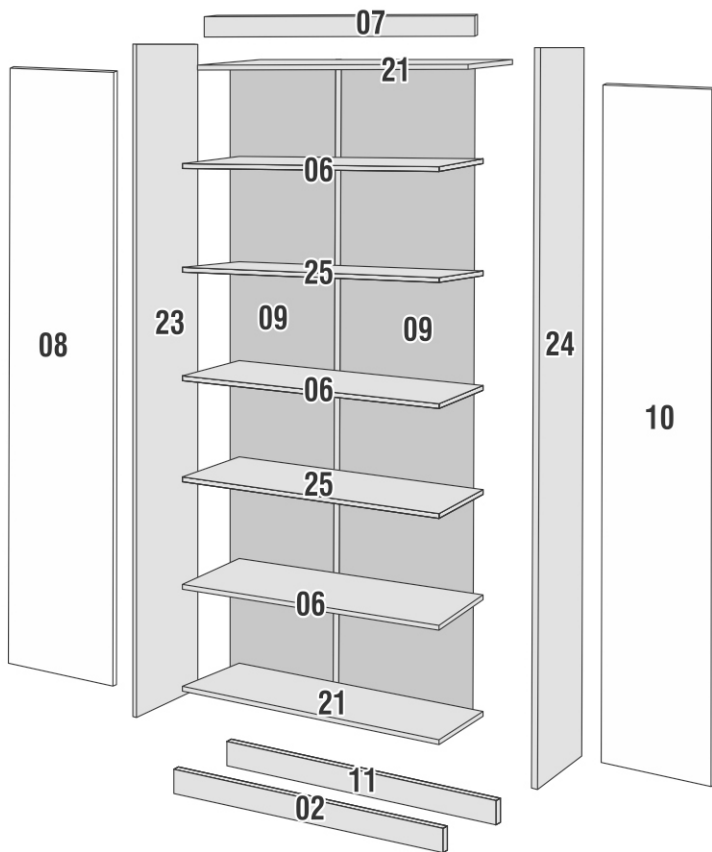

Prateleira Fixa
Fixed Shelf
Estante Fijo 2Pc



Prateleira Solta
Removable Shelf
Estante Removible 3Pc

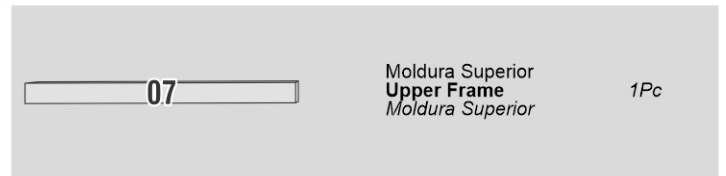

Moldura Superior
Upper Frame
Moldura Superior 1Pc



Porta Esquerda
Left Door
Puerta Izquierda 1Pc

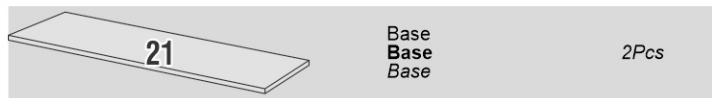

Base
Base
Base 2Pcs

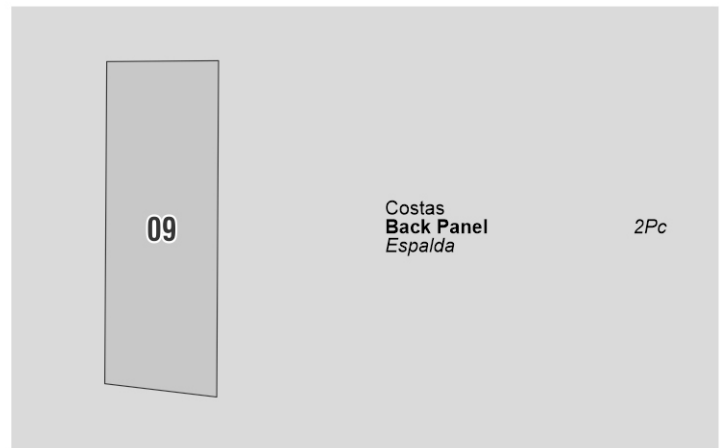

Costas
Back Panel
Espalda 2Pc



Rodapé Frontal
Front Baseboard
Rodapié Frontal 1Pc

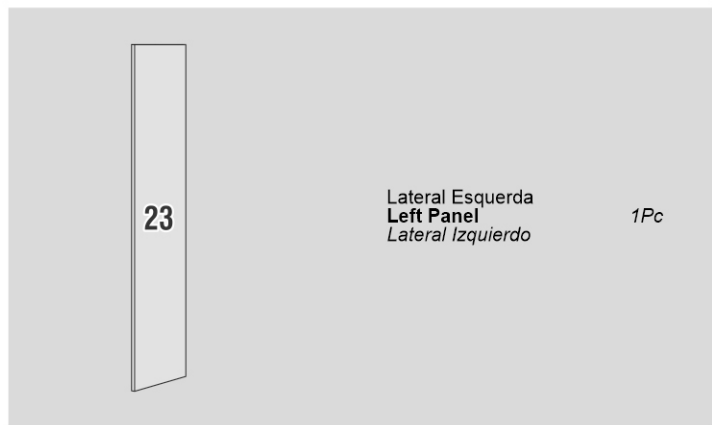

Lateral Esquerda
Left Panel
Lateral Izquierdo 1Pc



Porta Direita
Right Door
Puerta Derecha 1Pc



Lateral Direita
Right Panel
Lateral Derecho 1Pc

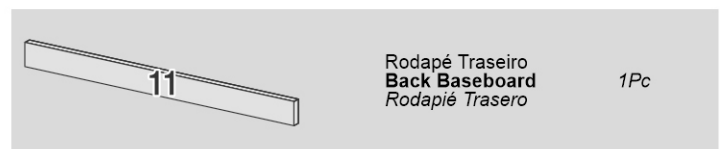

Rodapé Traseiro
Back Baseboard
Rodapié Trasero 1Pc

Passo 01 PARAFUSE AS PEÇAS 21 E 25 NA PEÇA 23 COM PARAFUSO 5X40 (J).
Step 01 SCREW PARTS 21 AND 25 INTO PART 23 WITH 5X40 SCREW (J).
 Paso 01 ATORNILLE LAS PARTES 21 Y 25 A LA PARTE 23 CON TORNILLO 5X40 (J).

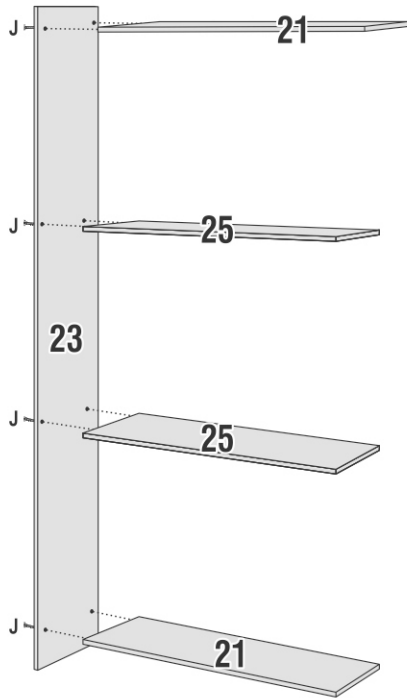

Passo 02 PARAFUSE A PEÇA 02 E 11 NA PEÇA 23 COM PARAF. 5x40 (J) 3 CAVILHA 6x30 (D);
Step 02 SCREW PARTS 02 AND 11 INTO PART 03 WITH 5x40 SCREW AND 6x30 DOWEL (D).
 Paso 02 ATORNILLE LAS PARTES 02 Y 11 A LA PARTE 03 CON TORNILLO 5x40 (J) Y CLAVIJA 6x30 (D).

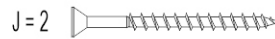

Passo 03 PARAFUSE A PEÇA 24 NAS PEÇAS 21, 02, 25 E 11 COM PARAF. 5x40 (J) E CAVILHA 6x30 (D).
Step 03 SCREW PART 24 INTO PARTS 21, 02, 25 AND 11 WITH 5x40 SCREW AND 6x30 DOWEL (D).
 Paso 03 ATORNILLE LA PARTE 24 A LAS PARTES 21, 02, 25 Y 11 CON TORNILLO 5x40 (J) Y CLAVIJA 6x30 (D).

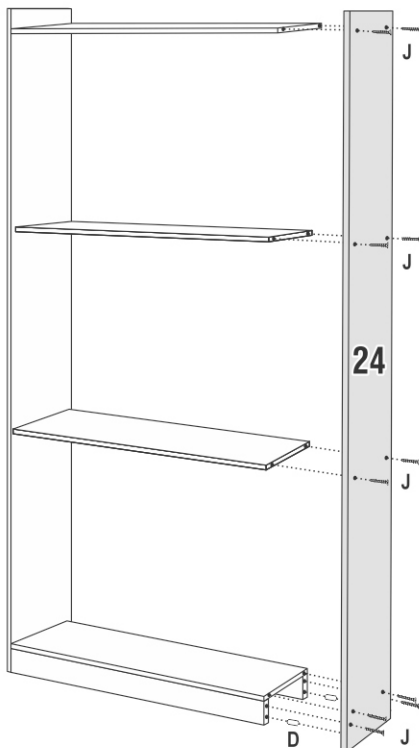

Passo 04 PREGUE AS COSTAS COM PREGO 8x8 (L) E PARAFUSE OS PÉS (P) COM PARAF. 3,5x12 FLANGEADO (Q).
Step 04 NAIL THE BACK WITH 8x8 NAIL (L) AND SCREW FEET (P) WITH 3,5x12 FLANGED SCREW (Q).
 Paso 04 CLAVE LA TRASERA CON CLAVO 8x8 (L) Y ATORNILLE PATAS (P) CON TORNILLO 3,5x12 FLANGEADO (Q).

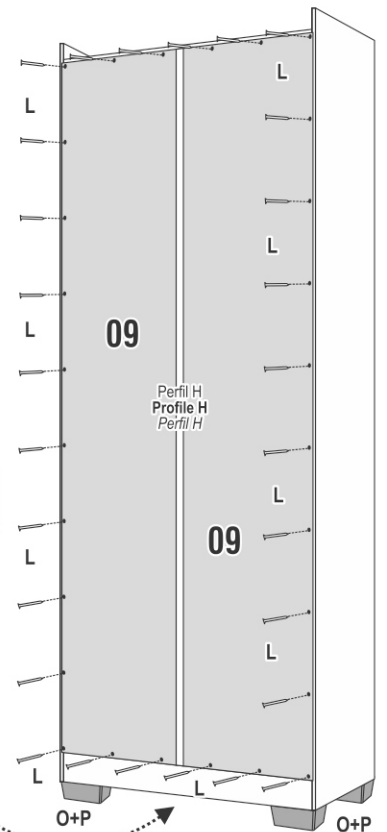
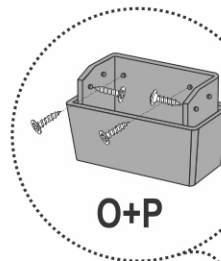

Passo 05 FIXAR A PEÇA 07 COM CANTONEIRA 4 FUROS(C) E PARAFUSO 3,5x12(G).
 Step 05 ATTACH PART 07 WITH 4-HOLE ANGLE BRACKET AND 3,5x12 SCREW(G).
 Paso 05 FIJE LA PARTE 07 CON ÁNGULO REFUERZO 4 AGUJEROS(C) Y TORNILLO 3,5x12(G)

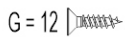
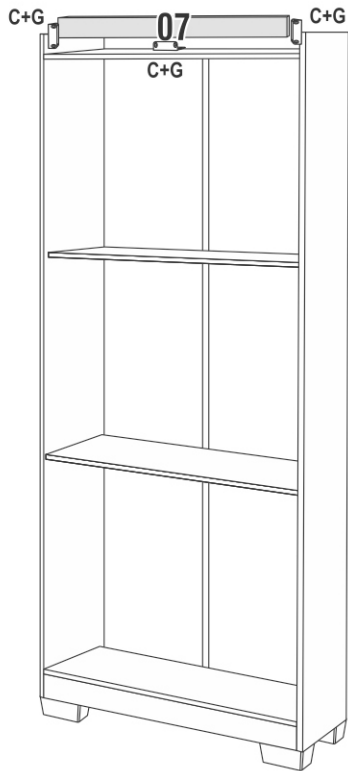

Passo 06 MONTE AS PRATELEIRAS 6 COM PINO SUPORTE 6x8(K).
 Step 06 INSERT SHELVES 6 WITH 6x8 SHELF SUPPORT(K).
 Paso 06 PONGA LOS ESTANTES 6 CON SOPORTE ESTANTE 6x8(K).

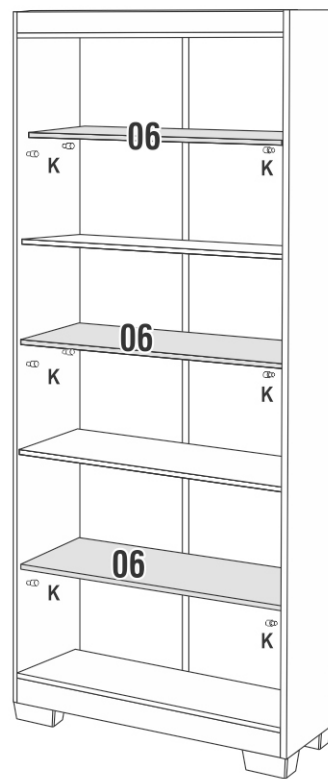

Passo 07 LEVANTE O MÓVEL E COLOQUE AS PORTAS USANDO TODAS OS FERRAGENS ABAIXO.
 Step 07 LIFT THE PIECE AND PLACE THE DOORS USING ALL HARDWARE PARTS BELOW.
 Paso 07 ERGA EL MUEBLE Y PONGA LAS PUERTAS USANDO TODOS LOS HERRAJES ABAJO.

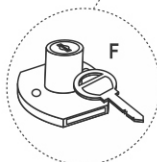
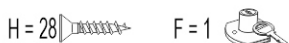
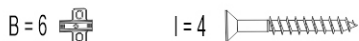
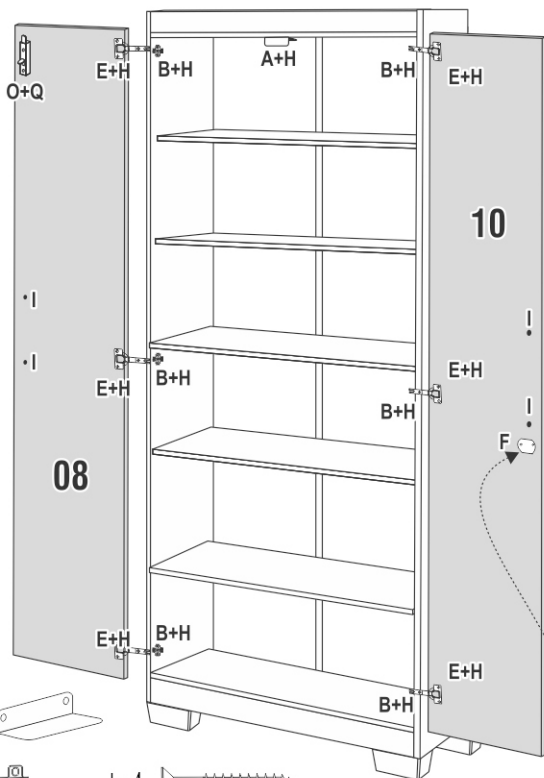

Passo 08 PRODUTO MONTADO.
 Step 08 PRODUCT ASSEMBLED.
 Paso 08 PRODUCTO MONTADO.

