

# ME-4110

## Instruções de Montagem Instrucciones de Montaje

Acesse Vídeos de Montagens  
[www.tecnomobili.ind.br](http://www.tecnomobili.ind.br)

**tecnomobili**

Estrada RSC 453, Km s/n° | Garibaldi | RS  
CEP: 95720-000 | Fone / Fax: 54.3464.2050  
sac@moveisvideira.com.br

### Notas especiais:

- 01** - Examine completamente todas as peças do móvel antes de iniciar o trabalho.  
**02** - Recomenda-se montar o móvel conforme este Manual de Montagem.  
**03** - É de responsabilidade do montador seguir as instruções do Manual de Montagem, que são fundamentais para garantir a estrutura do móvel.  
**04** - Para limpeza utilizar somente pano úmido e sabão neutro.

### Notas especiales:

- 01** - Examine completamente todas las piezas del mueble antes de iniciar el trabajo.  
**02** - Se recomienda montar el mueble conforme el Manual de Esamblaje.  
**03** - Es de responsabilidad del montador seguir las instrucciones del Manual de Esamblaje, que son fundamentales para garantizar la estructura del mueble.  
**04** - Para limpieza solamente usar trapo húmedo y jabón neutro.

### Certificado de garantia:

A garantia dos produtos fabricados pela Móveis Videira LTDA, abrange eventuais defeitos/vícios de fabricação, no prazo estabelecido pelo Código de Defesa do Consumidor, em seu artigo 26,II, o qual prevê a garantia legal de 90 (noventa) dias.

Revisão: 05  
Data: 26/11/2015

### Ferramentas | Herramientas

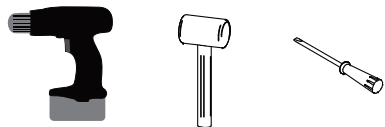



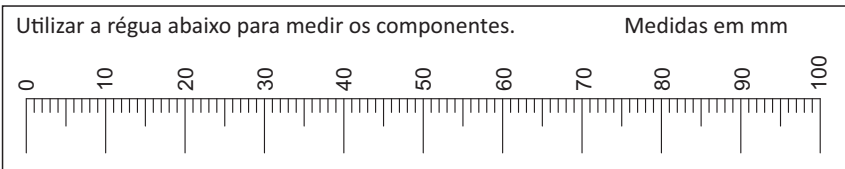





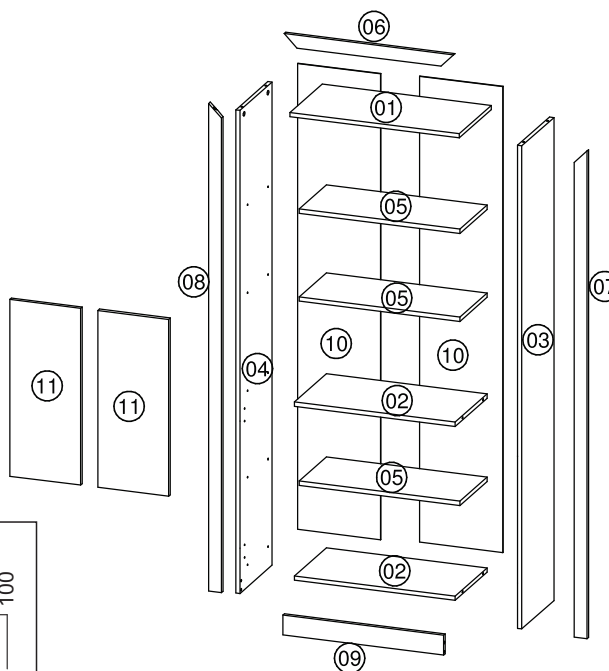







30 min.



### Lista de peças / Lista de piezas

CÓD	DESCRIÇÃO	QTD	M. PRIMA	DIMENSÕES
01	Tampo	1	MDP 15mm	300 x 598 x 15mm
02	Base	2	MDP 15mm	300 x 568 x 15mm
03	Lateral Direita	1	MDP 15mm	1694 x 300 x 15mm
04	Lateral Esquerda	1	MDP 15mm	1694 x 300 x 15mm
05	Prateleira Móvel	3	MDP 15mm	255 x 568 x 15mm
06	Travessa	1	MDP 15mm	599 x 45 x 15mm
07	Travessa Direita	1	MDP 15mm	1710 x 45 x 15mm
08	Travessa Esquerda	1	MDP 15mm	1710 x 45 x 15mm
09	Rodapé	1	MDP 15mm	70 x 568 x 15mm
10	Costa	2	Chapa Dura 3mm	1634 x 294 x 3mm
11	Porta	2	MDP 15mm	620 x 250 x 15mm

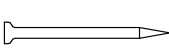
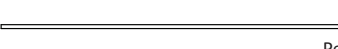

REF	DESCRIÇÃO	QTD
A	 Cavilha 8 x 30mm	04
B	 Parafuso 3,5 x 14mm CF	20
C	 Parafuso 3,5 x 16 CC	08
D	 Parafuso 3,5 x 30CP	02
E	 34x7mm Parafuso minifix	12
F	 15x12mm Tambor minifix	16
G	 38x38mm Minifix haste dupla	02
H	 22x17x12mm Suporte angular	10
I	 40x20x21mm Puxador Ponto	02
J	 Adesivo Tapafuro	04
K	 14x4mm Sapata	04
L	 80x48x31mm Dobradiça	04
M	 14x8x5mm Suporte de prateleira	12
N	 22x3mm Prego 10 x 10CC	45
O	 Perfil 1609mm	01
P	 50x25x25mm Sapata Retangular	04
Q	 Parafuso 3,5x40CC	08

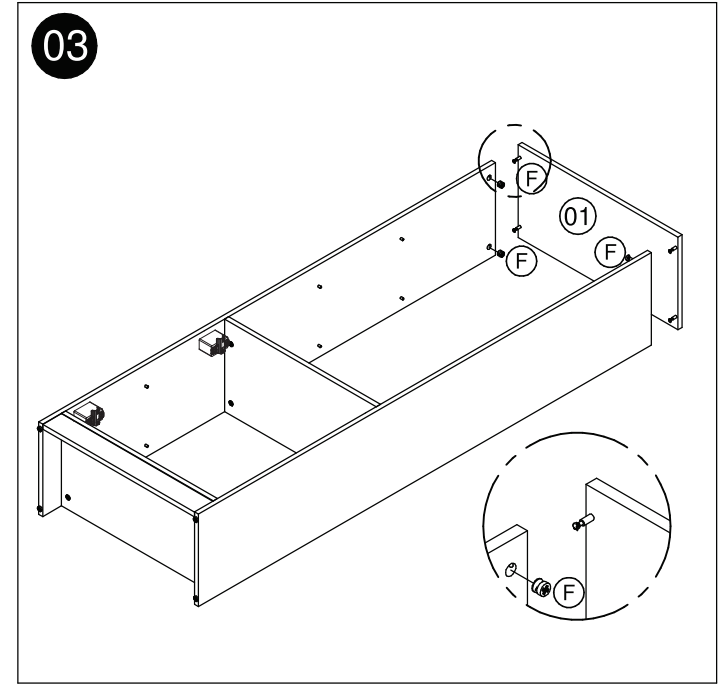
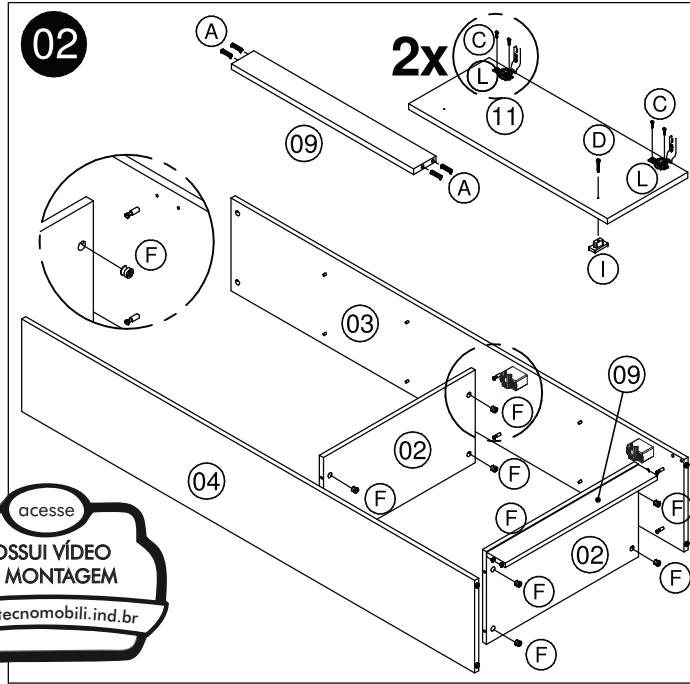
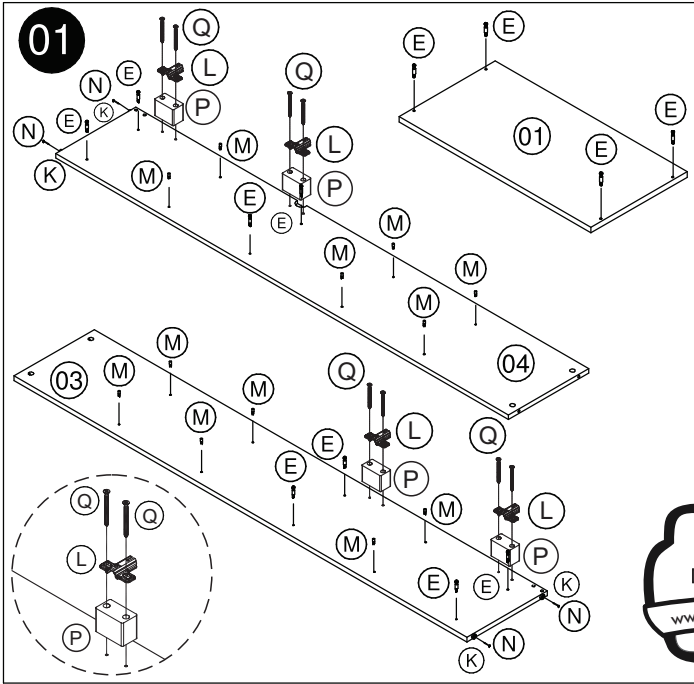

acesse  
**POSSUI VÍDEO DE MONTAGEM**  
[www.tecnomobili.ind.br](http://www.tecnomobili.ind.br)

