

# Balcão Tamburato 2 Portas

## Credenza Tamburato 2 Puertas

### Executive 2 Doors Cabinet

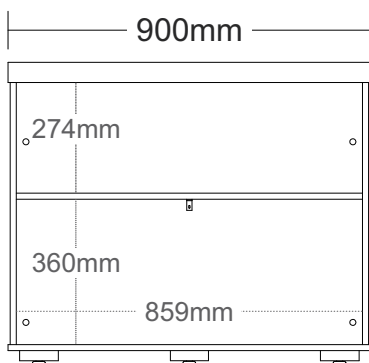
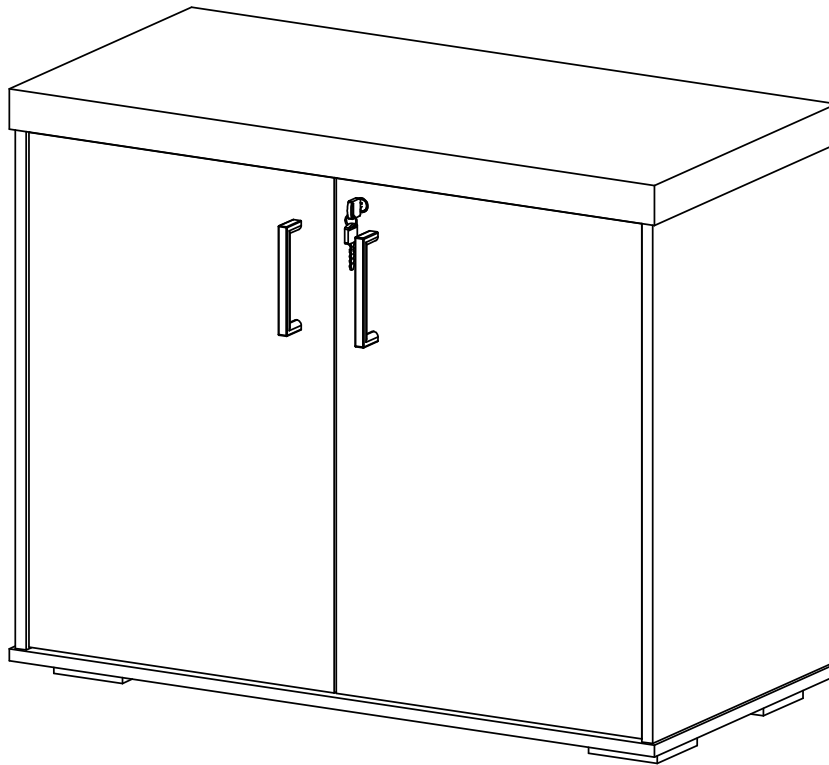

Frente  
Frente / Front

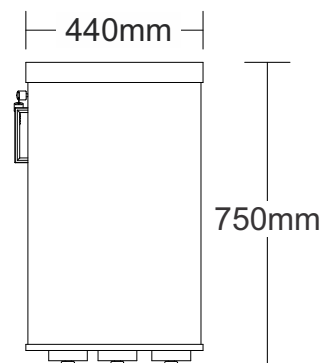

Lateral  
Lado / Side

**ARTANY**<sup>®</sup>  
Arte em Home Office

Conheça outros produtos da nossa empresa no site: [www.artany.com.br](http://www.artany.com.br)

Conozca otros productos en el sitio: [www.artany.com.br](http://www.artany.com.br)

Know another products in: [www.artany.com.br](http://www.artany.com.br)

- Siga atentamente todas as instruções de montagem;
- Monte seu produto no local ou próximo de onde será colocado. Movimentações do produto já montado, podem avariá-lo;
- Faça a montagem em uma superfície limpa e plana. Aconselhamos usar a própria embalagem de papelão para forrar o chão;
- Verifique se as quantidades de peças e acessórios estão de acordo com o manual de montagem;
- Compare atentamente os furos de cada peça com a ilustração do manual;
- Utilize as ferramentas indicadas. Só utilize parafusadeira se tiver conhecimento e habilidade. O uso inapropriado pode danificar peças e/ou acessórios;
- Se o produto necessitar fixação na parede, tenha cuidado para não atingir fios e canos ao furar a parede.

**Obs:** Caso necessite solicitar peças de reposição, por favor, utilize os códigos dos mesmos.

- Siga con atención todas las instrucciones de armado.
- Arme su mueble en un lugar cerca donde será instalado. Mover el producto ya montado puede perjudicarlo.
- Haga el montaje en una superficie limpia y plana. Aconsejamos usar el propio embalaje de cartón para forrar el suelo.
- Asegúrese de que las cantidades de piezas y accesorios coincidan con el manual de montaje.
- Compare cuidadosamente los agujeros de cada pieza con la ilustración del manual.
- Utilice las herramientas indicadas. Sólo utilice atornillador automático si tiene conocimiento y habilidad. El uso inapropiado puede dañar piezas y/o accesorios.
- Si el producto necesita fijación en la pared, tenga cuidado de no alcanzar cables y tuberías al perforar la pared.

**OBS:** Si necesita solicitar piezas y / o accesorios de repuesto, por favor, utilice los códigos de los mismos.

- Follow carefully the assembly instructions.
- Assemble your furniture in a place near where it will be installed. Moving the assembled product can harm it.
- Make the assembly on a clean and flat surface. We recommend using the cardboard box to cover the floor.
- Make sure the quantities of parts and accessories match the assembly manual.
- Carefully compare the holes in each piece with the illustration in the manual.
- Use the indicated tools. Only use an automatic screwdriver if you have knowledge and skill. Improper use can damage parts and/or accessories.
- If the product needs fixing on the wall, be careful and don't reach cables and pipes when drilling the wall.

**NOTE:** If you need to request spare parts and/or accessories, please use the codes according of this instruction manual.

## CONSERVAÇÃO E LIMPEZA

### MANTENIMIENTO Y LIMPIEZA / MAINTENANCE AND CLEANING

Não expor o produto ao sol, altas temperaturas e umidade, mantendo-o em local seco e arejado. Para a limpeza, utilizar um pano seco e macio. Não é necessário o uso de materiais abrasivos ou álcool.

*No exponga el producto al sol, altas temperaturas y la humedad. Mantener en local seco y ventilado. Para limpiar, utilice un paño suave y seco. No es necesario el uso de materiales abrasivos o alcohol.*

*Do not expose the product to sunlight, high temperatures and humidity. Keep it in a dry and ventilated place. To clean it, use a soft and dry cloth. It is not necessary to use abrasive materials or alcohol.*

## Garantia

Este certificado de Garantia é uma vantagem adicional oferecida ao consumidor, porém para que o mesmo tenha validade é imprescindível que seja apresentada a NOTA FISCAL de compra do produto e o número do lote (ver etiqueta).

Com este produto, a **Artany** tem como objetivo atender plenamente o proprietário-consumidor, proporcionando a garantia na forma aqui estabelecida, pelo período de 2 anos a partir da data da nota fiscal de compra. A **Artany** restringe a sua responsabilidade à substituição gratuita das peças defeituosas, em caso de defeitos ou avarias devidamente constatados como sendo de fabricação, durante a vigência desta garantia.

A **Artany** declara a garantia nula e sem efeito se o produto for alterado, adulterado, molhado ou consertado e ainda pela prática de montagem inadequada. Também será considerada nula em casos de força maior, como aqueles causados por agentes da Natureza (chuvas, incêndios, excesso de umidade...).

Para exercer seus direitos de comprador é importante que antes de montar seu produto você leia com atenção as instruções de cada passo do manual de montagem que acompanha o móvel.



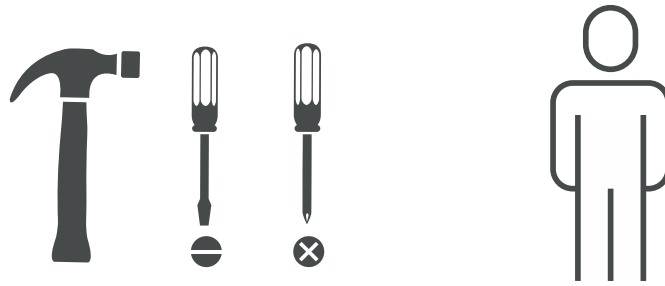

Caso o produto não esteja em conformidade, entre em contato com a loja onde efetuou a compra ou com o nosso Serviço de Atendimento ao Cliente através do fone (41) 3556 1500 ou do e-mail [assistencia@artany.com.br](mailto:assistencia@artany.com.br), e faça sua reclamação, apontando os defeitos técnicos observados, que teremos o maior prazer em atendê-lo. Para agilizar o seu atendimento, tenha sempre em mãos o manual de montagem com os respectivos números das peças defeituosas conforme descritas no manual.

FERRAMENTAS **NÃO** FORNECIDAS, MAS NECESSÁRIAS  
PARA A MONTAGEM DO PRODUTO

HERRAMIENTAS **NO** SUMINISTRADAS, PERO NECESARIAS PARA EL MONTAJE DEL PRODUCTO  
TOOLS **NOT** SUPPLIED, BUT NECESSARY FOR THE ASSEMBLY

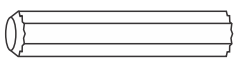
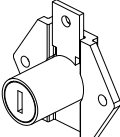
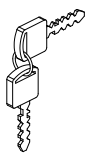
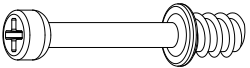

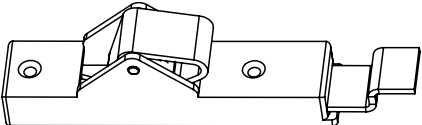
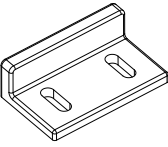
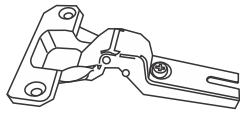
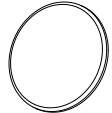
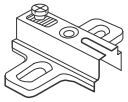
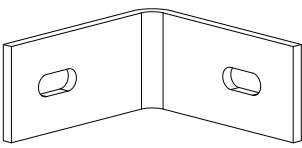
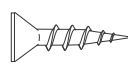
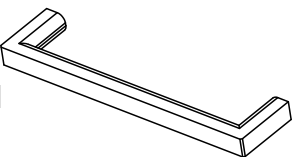
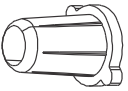
LISTA DE MATERIAIS  
LISTA DE MATERIALES  
HARDWARE LIST

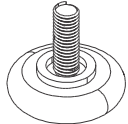
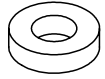
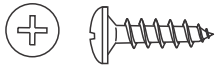
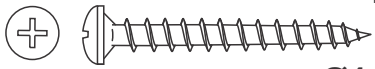
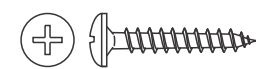
A		Cavilha Tarugo / Dowel Ø6x30mm	12x	I				
B		Minifix Minifix / Minifix Ø7x32mm	10x	I		Arruela Arandela Washer		1x
C		Tambor Tambor Minifix Cam Ø15x12mm	10x	J				1x
D		Batente Solapa Metal stop	2x	K		Dobradiça Bisagra Hinge		4x
E		Tapa furo adesivo Adhesivo Hole Cover Ø18mm	8x	K		Calço Dobradiça Cuña de bisagra Hinge shim		
F		Cantoneira Cantonera Corner Brace 26x26mm	1x	K		Parafuso Tornillo Screw Ø4x16mm CC		16x
G		Puxador Tirador Handle 128mm	2x	L		Bucha sapata Buje pata Foot bushing		5x
G		Parafuso Tornillo Screw	4x	M		Sapata Pata Foot		5x
H		Arruela Arandela Washer	2x	N		Parafuso Tornillo Screw Ø4,0x14mm CP		8x
				O		Parafuso Tornillo Screw Ø4,0x35mm CP		14x
				P		Parafuso Tornillo Screw Ø4,0x20mm CP		2x

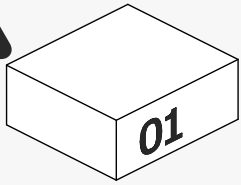

O número na borda da peça corresponde ao manual.  
Para remover, use um pano com álcool em gel ou álcool 70%.

El número que aparece en el borde de la pieza corresponde al manual.  
Para retirarlo, utilice un paño con alcohol en gel o alcohol al 70%.

The number on the edge of the piece corresponds to the assembly guide.  
To remove it, use a cloth with alcohol gel or 70% alcohol.

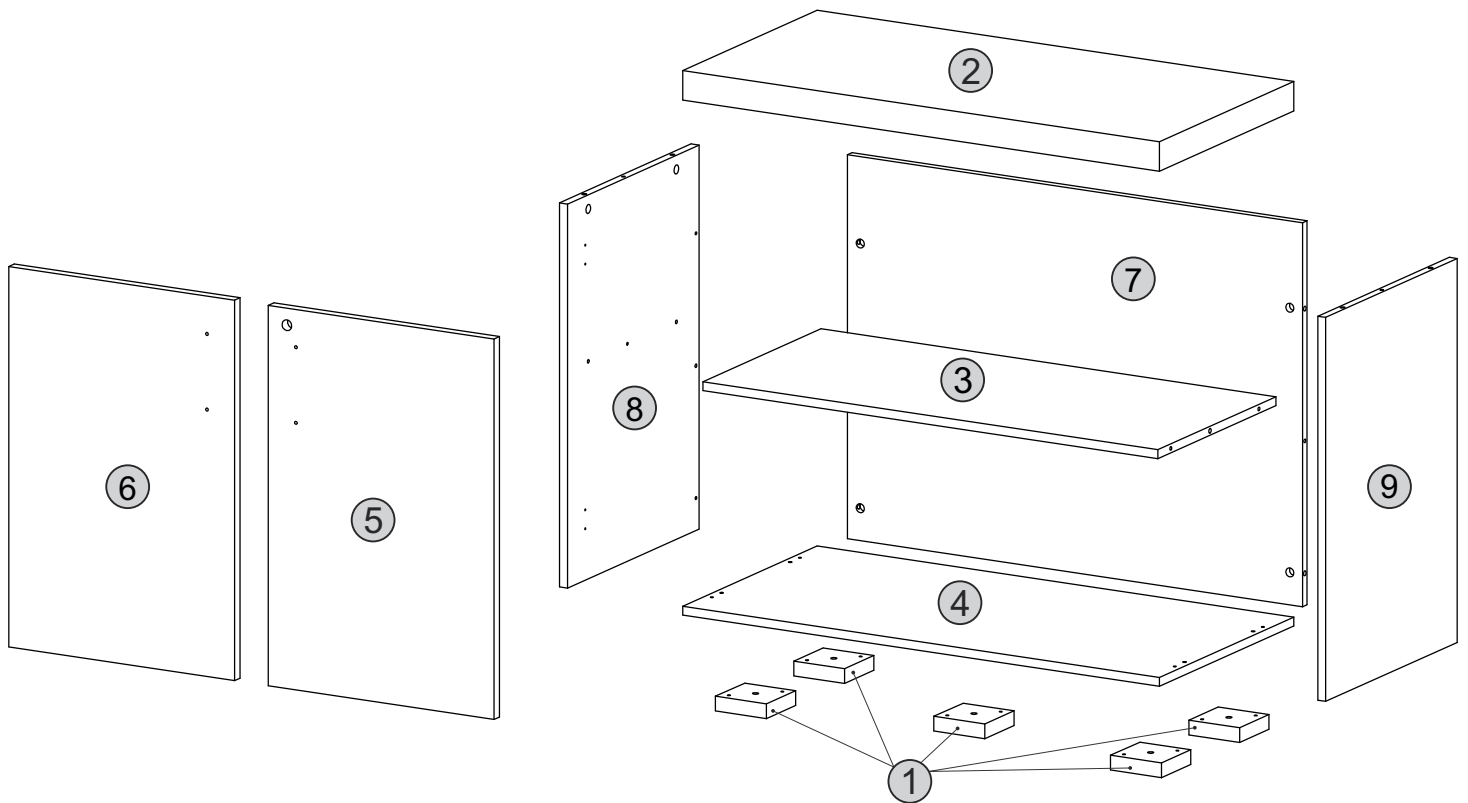

Descrição	Descripción	Description	Qty
1-Pé (96x96x25mm)	1-Pies	1-Foot	5
2-Tampo (900x440x50mm)	2-Tapa	2-Top	1
3-Prateleira (859x386x15mm)	3-Anaquele	3-Shelf	1
4-Base (900x440x15mm)	4-Base	4-Base	1
5-Porta direita (644x426x18mm)	5-Puerta Derecha	5-Right Door	1
6-Porta esquerda (644x426x18mm)	6-Puerta Izquierda	6-Left Door	1
7-Traseira (859x650x15mm)	7-Trasero	7-Back	1
8-Lateral esquerda (650x430x15mm)	8-Lado Izquierdo	8-Left Side	1
9-Lateral direita (650x430x15mm)	9-Lado Derecho	9-Right Side	1

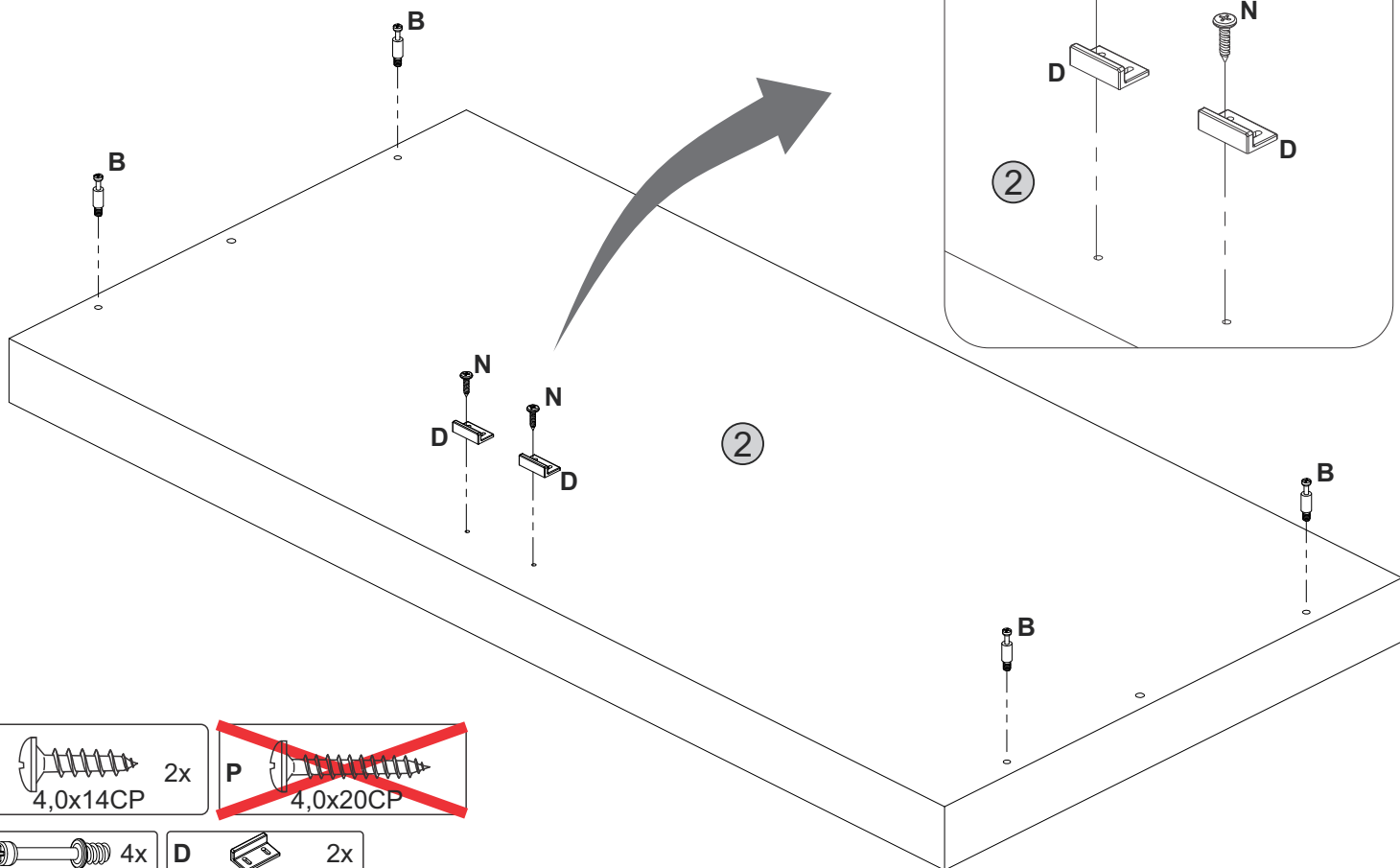
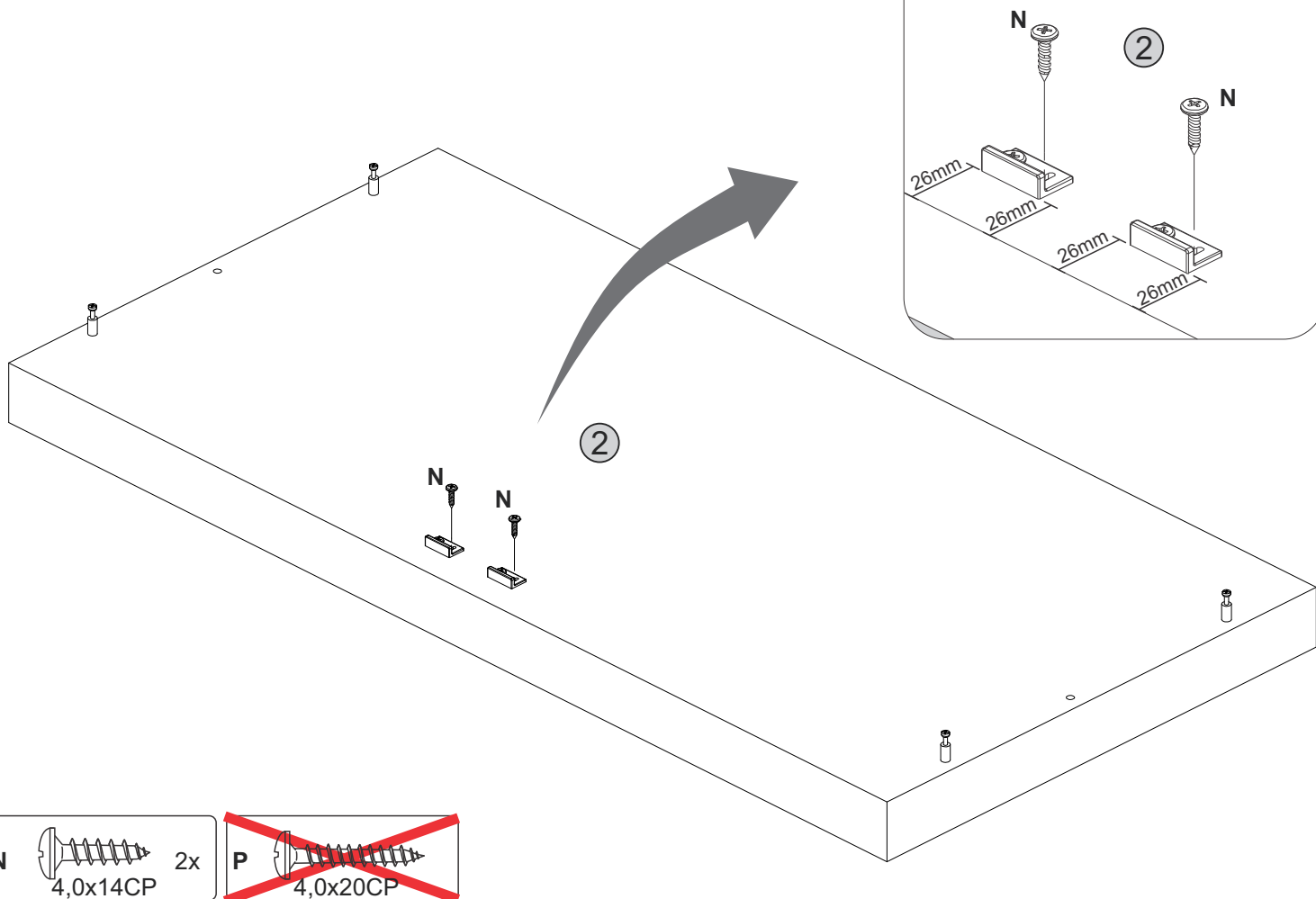
**1****2**

3

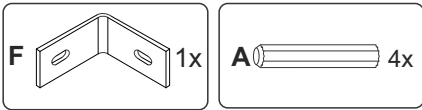
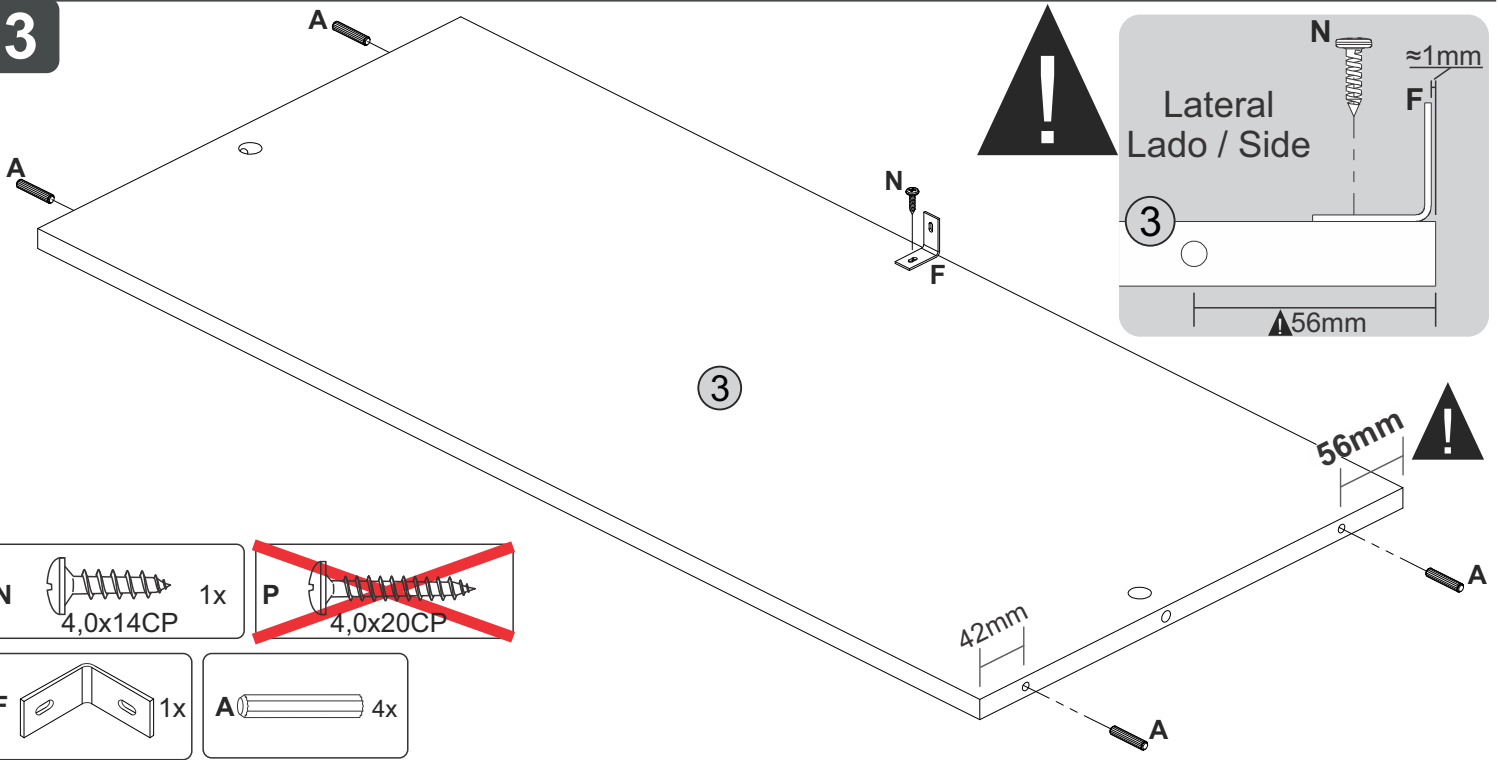

4

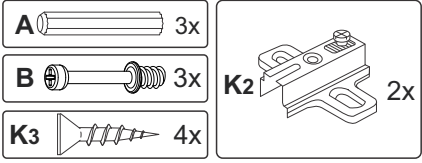
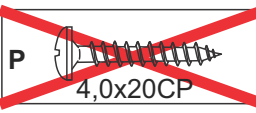
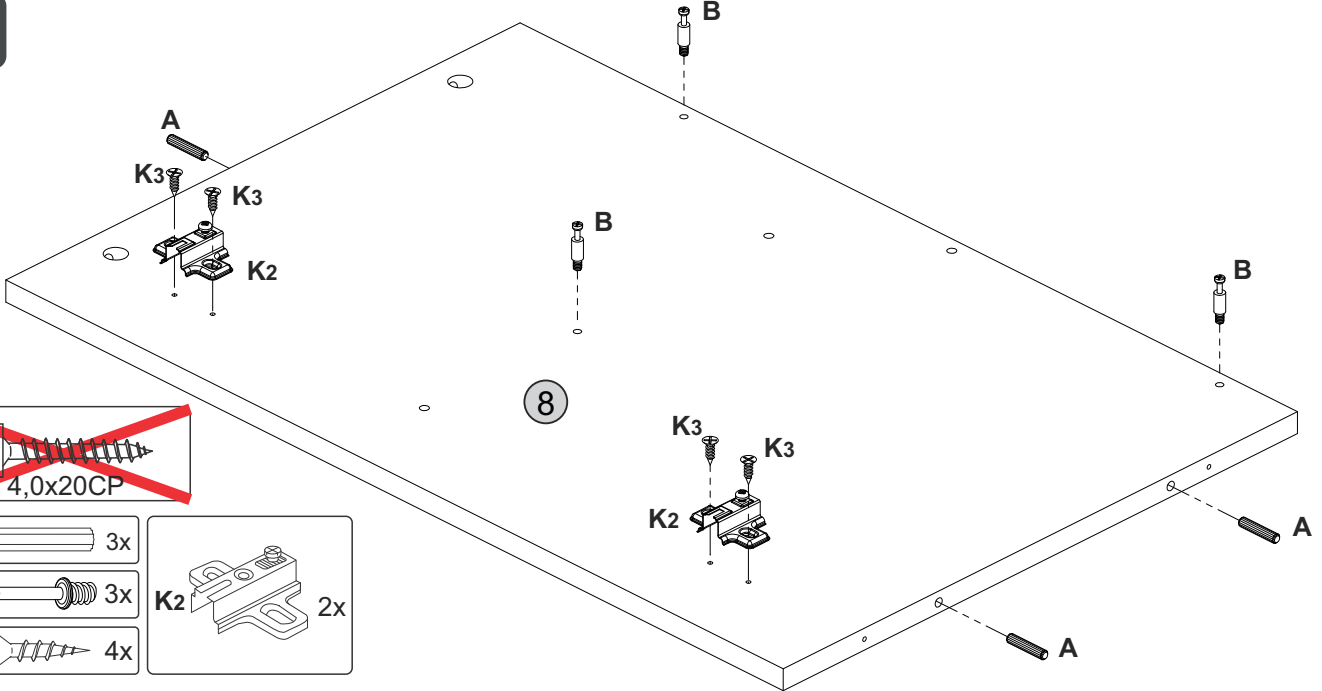



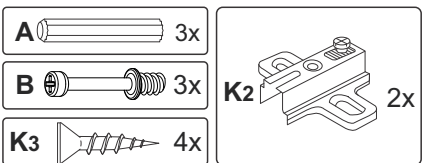
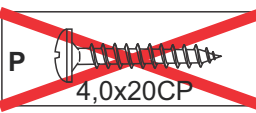
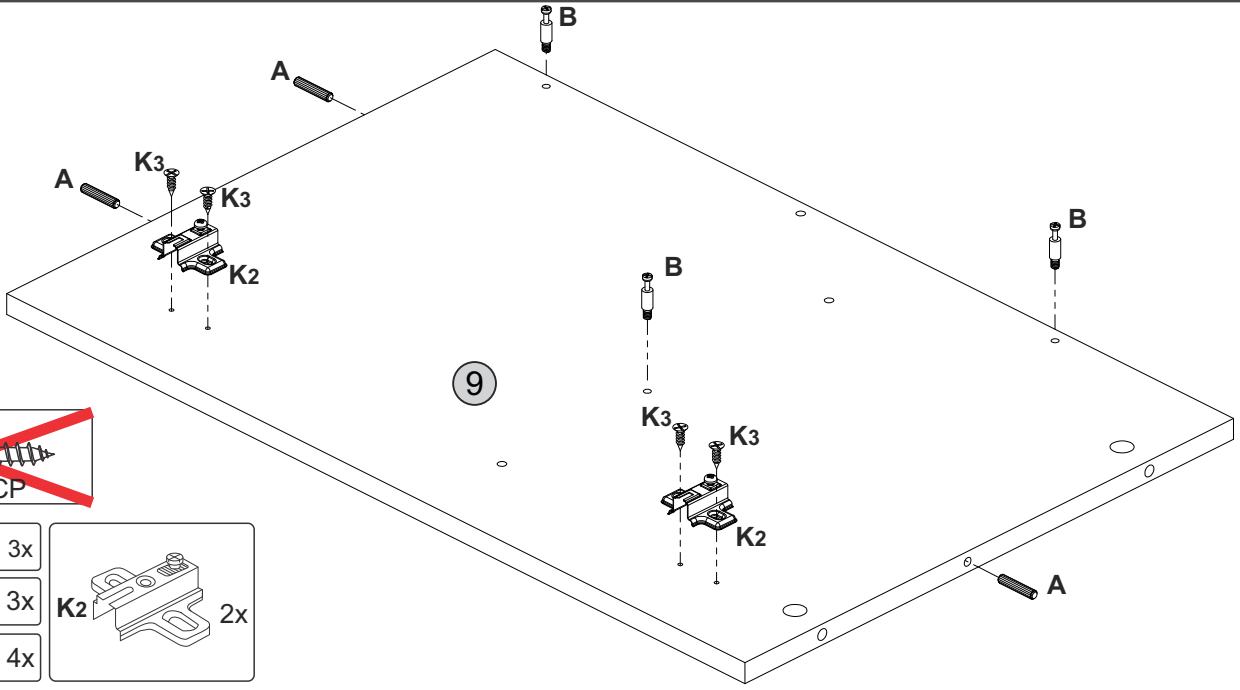

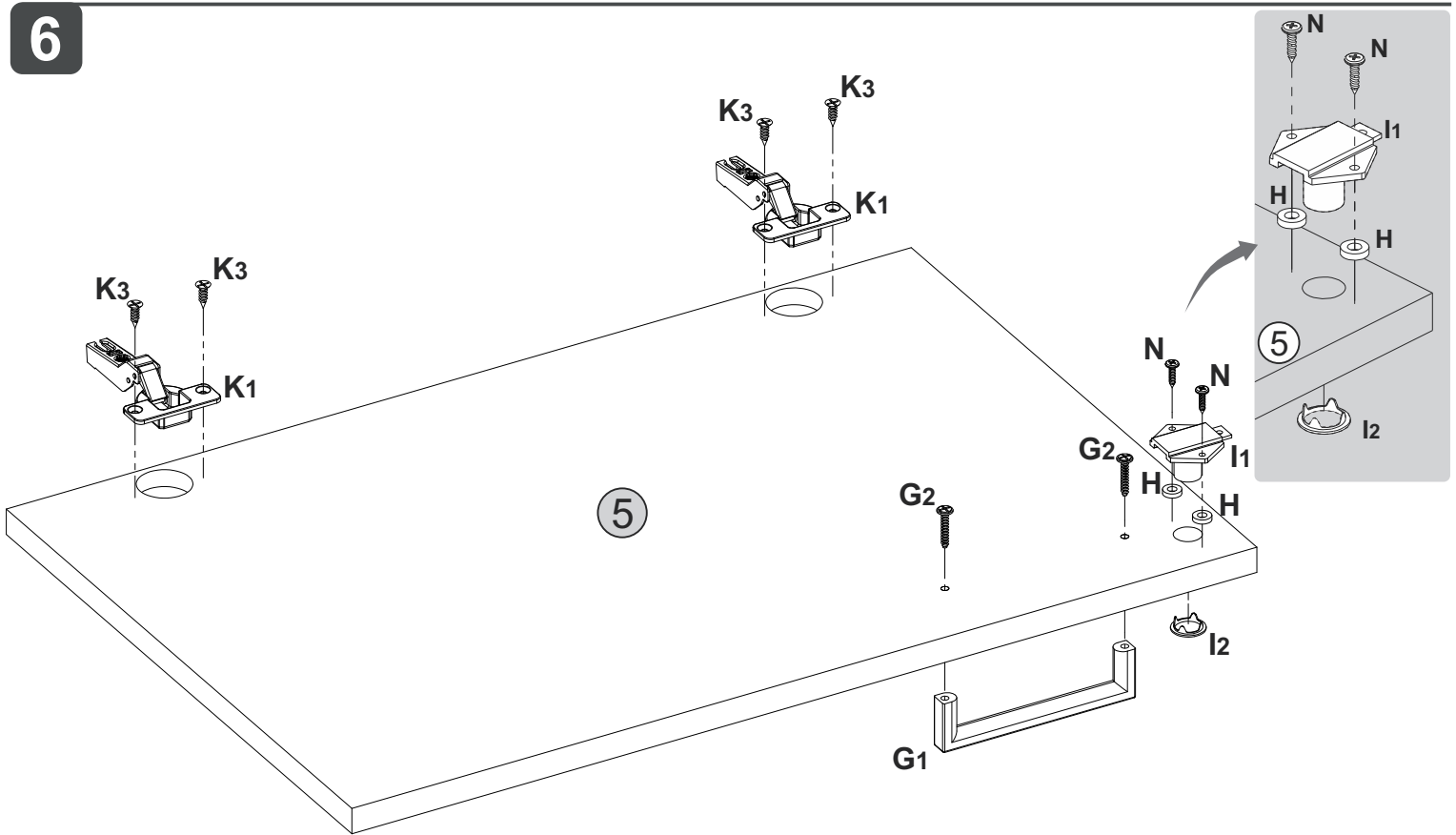

5







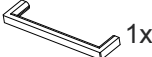
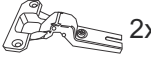

6

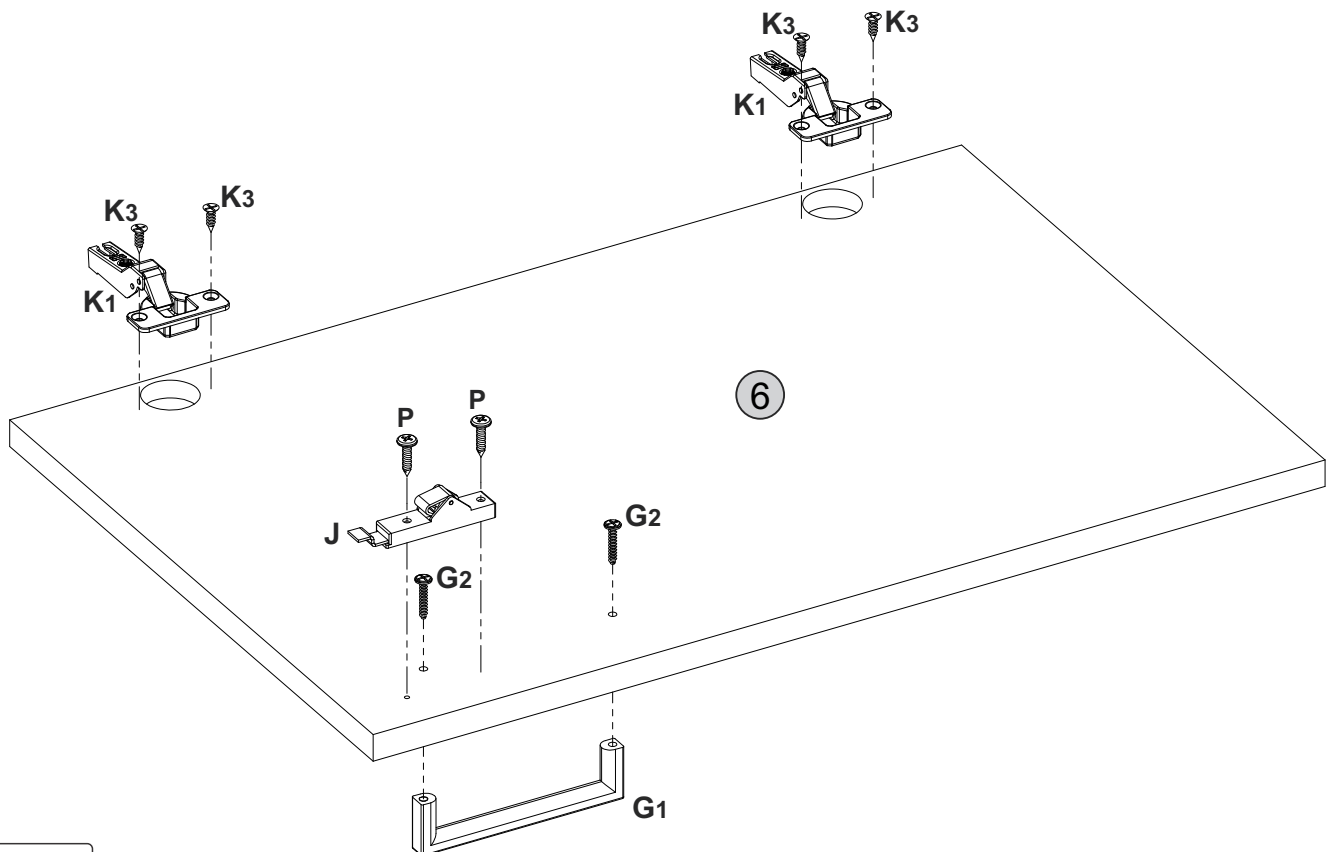

N	 2x	H	 2x	G2	 2x	K3	 4x	<del>P</del>	<del> 4,0x20CP</del>
I1	 1x	I2	 1x	G1	 1x	K1	 2x		

7



P	 2x 4,0x20CP	G2	 2x	K3	 4x
J	 1x	G1	 1x	K1	 2x

8

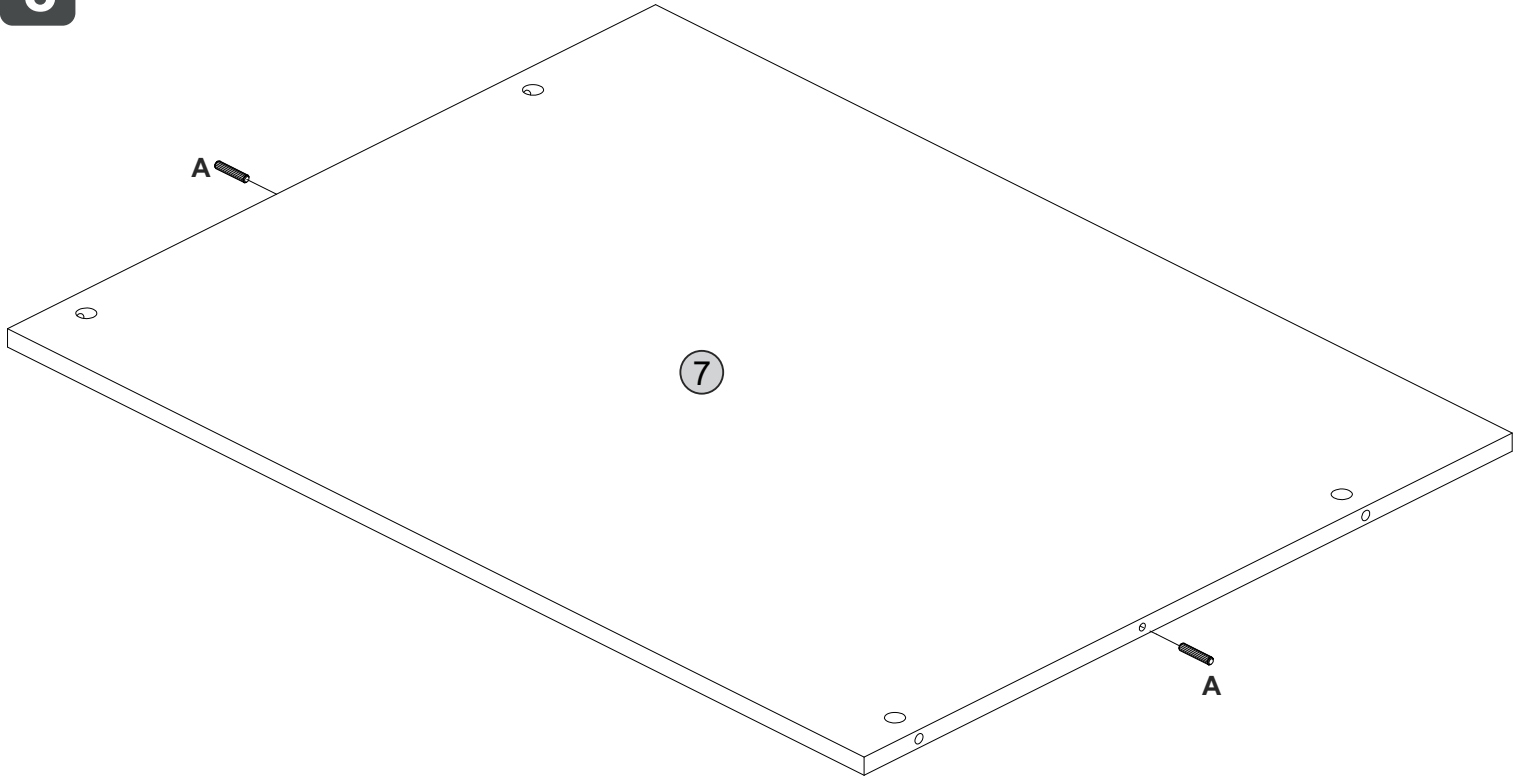

A  2x

9

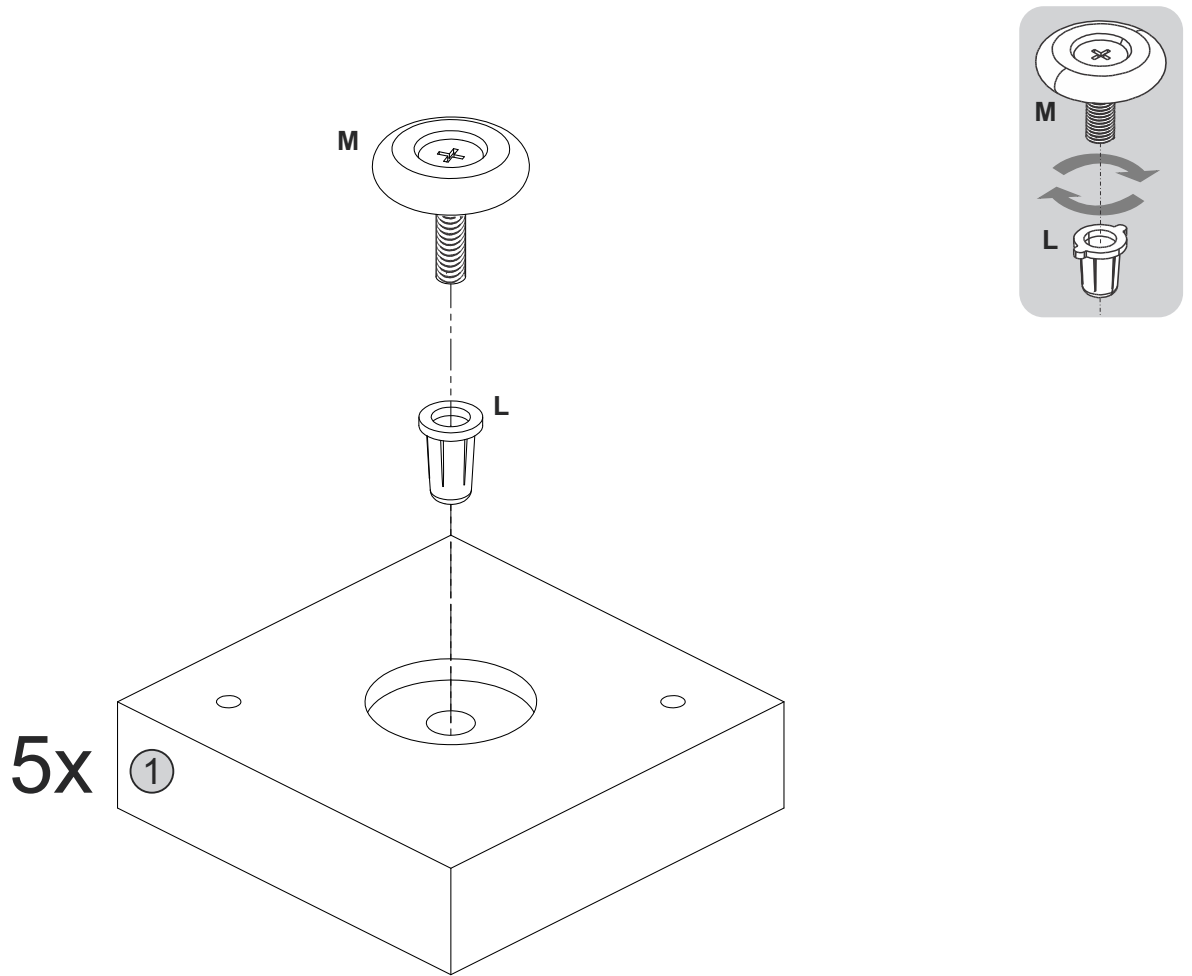

5x

L  5x M  5x



10

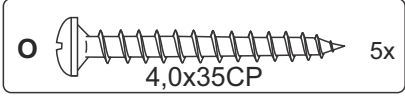
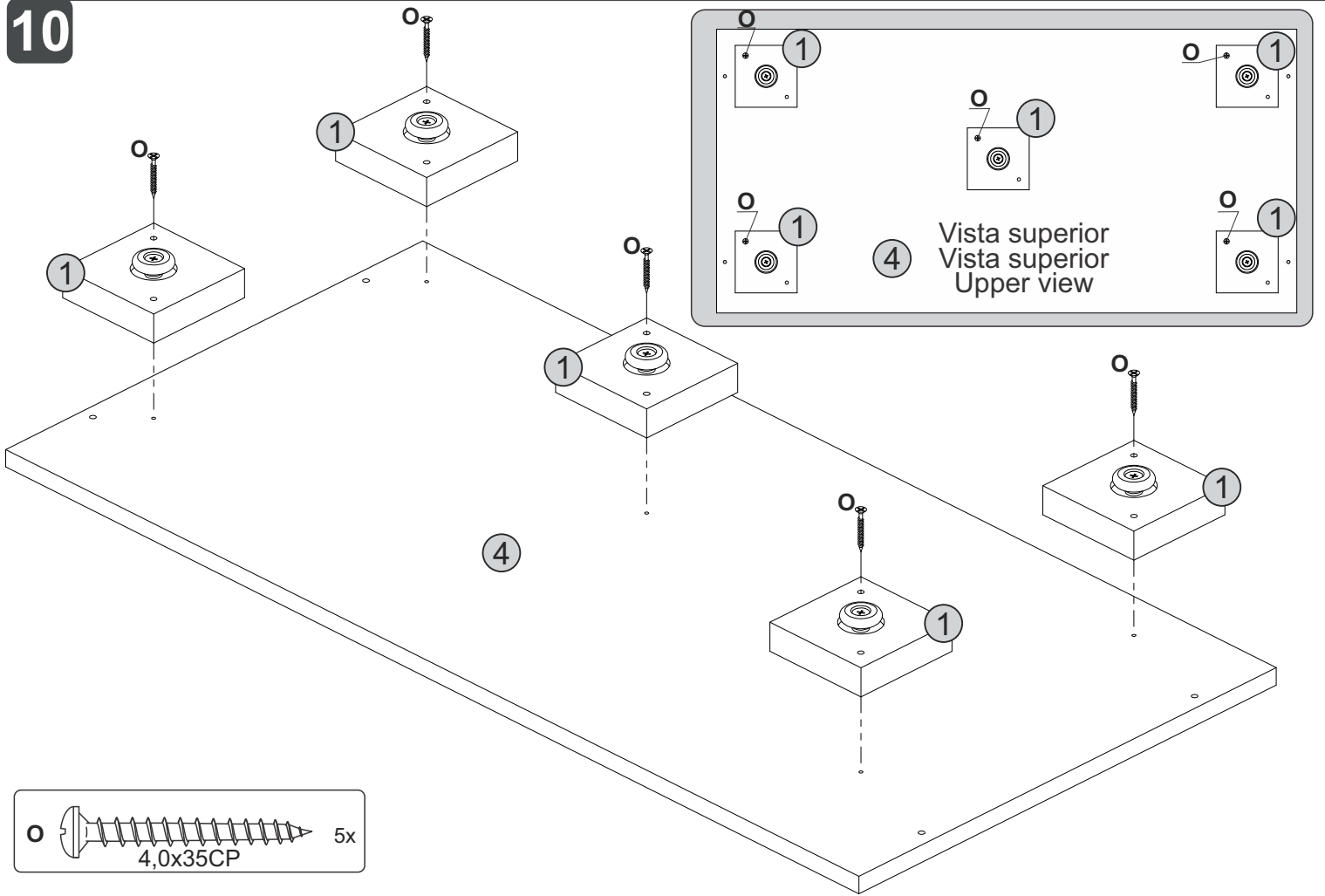

11

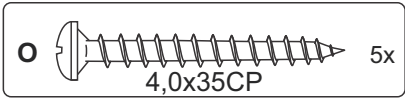
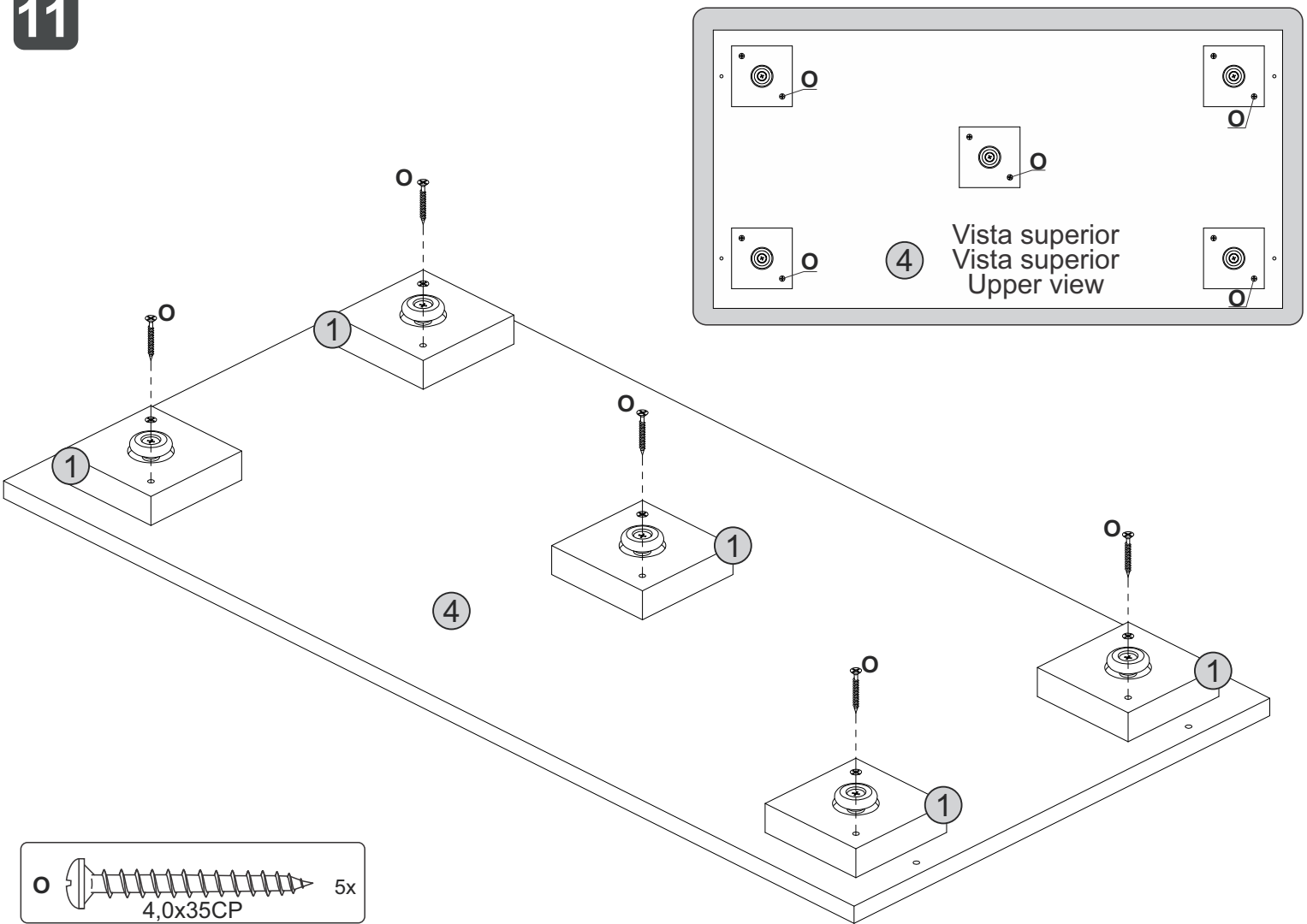

12

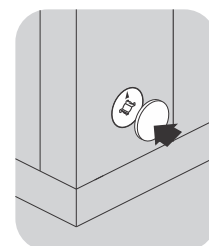
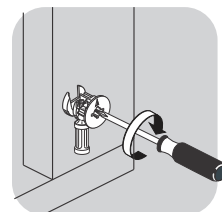
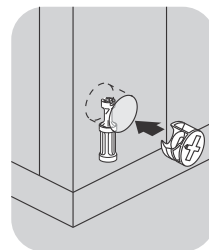
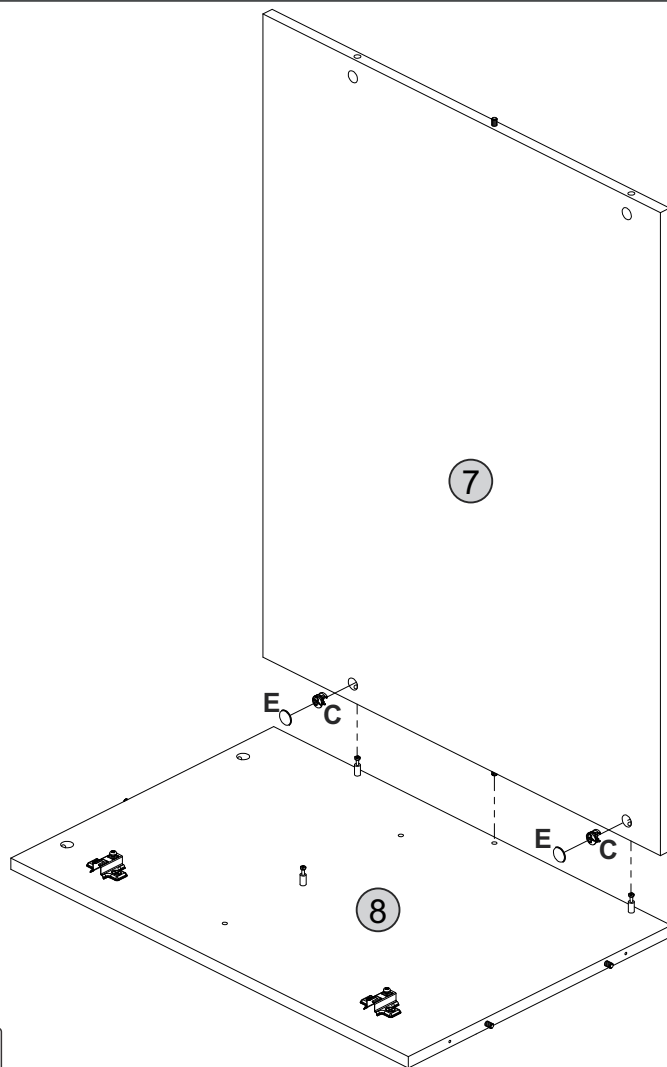

C  2x E  2x

13

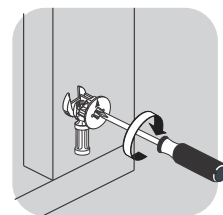
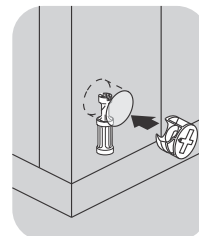
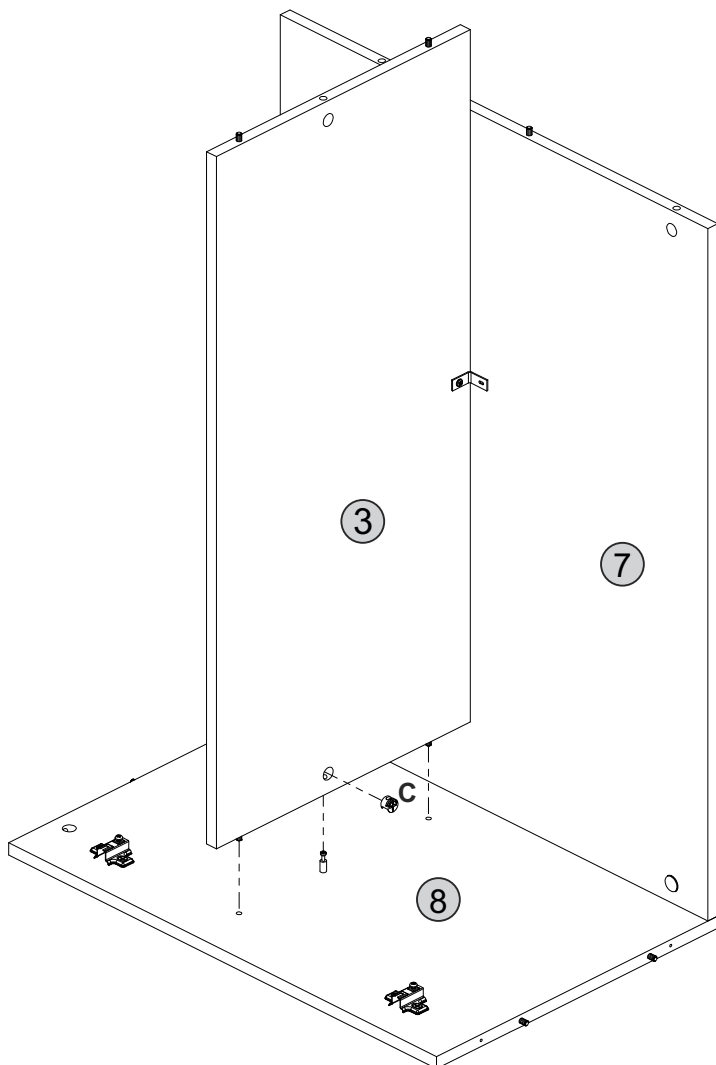

C  1x

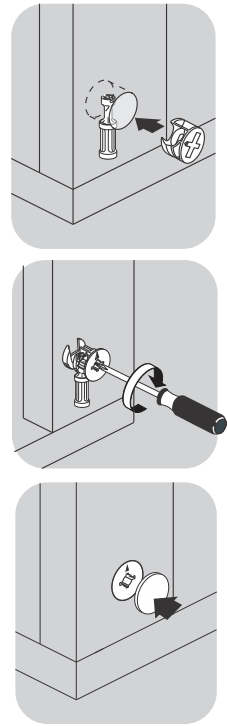
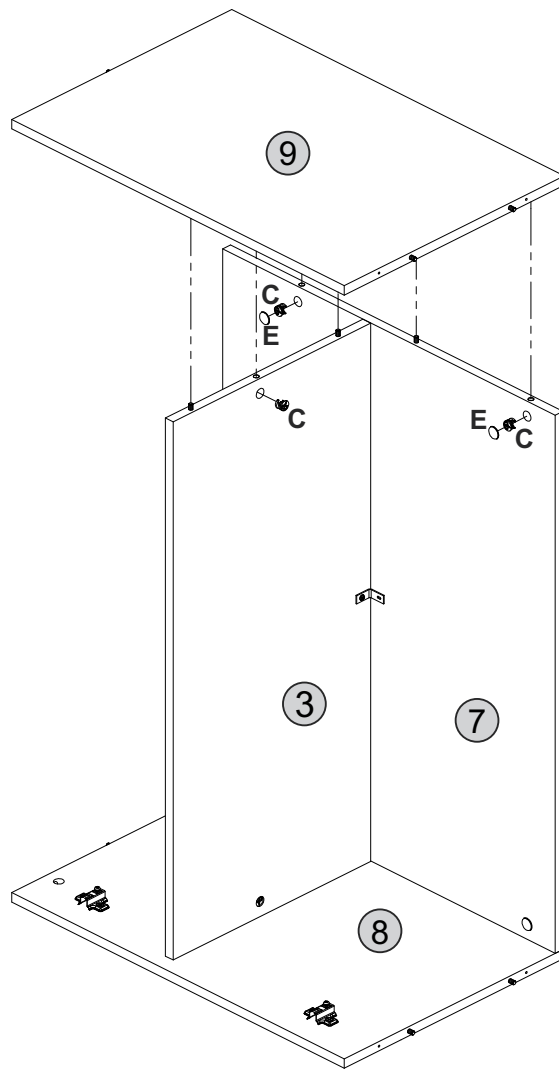

14

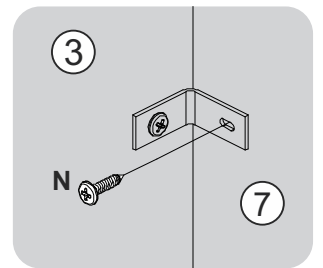
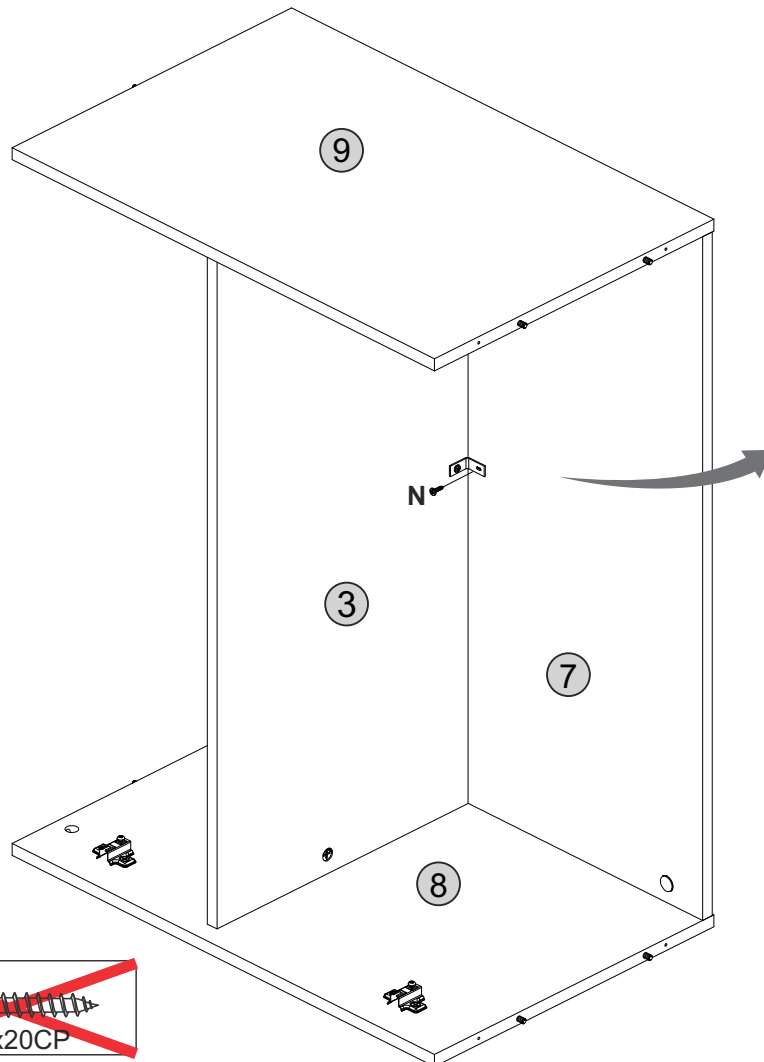

C  3x E  2x

15



N  1x ~~P ~~ 1x

4,0x14CP 4,0x20CP

16



Vire com cuidado.  
Gire con cuidado.  
Turn carefully.

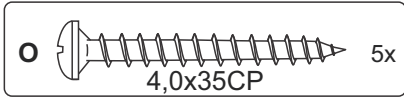
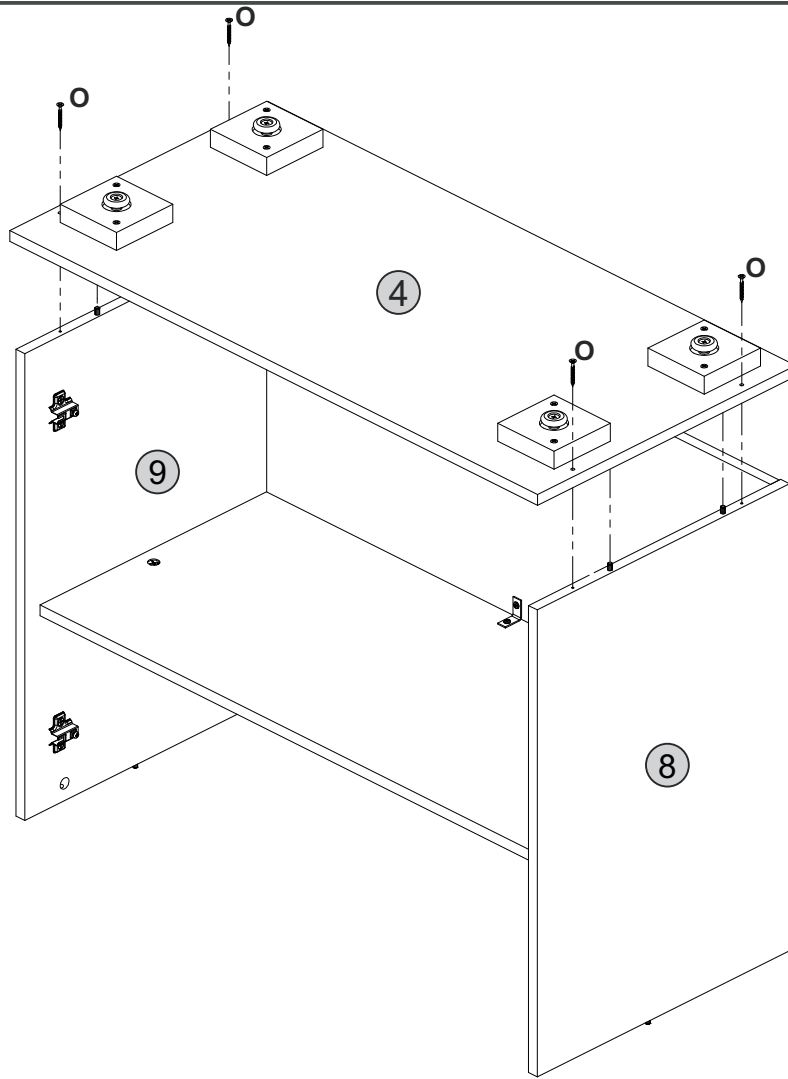

17



Vire com cuidado.  
Gire con cuidado.  
Turn carefully.

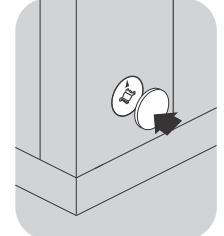
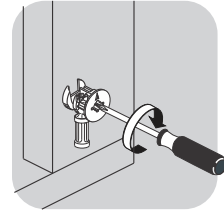
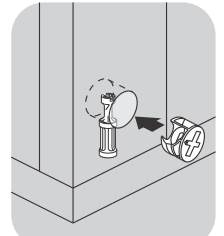
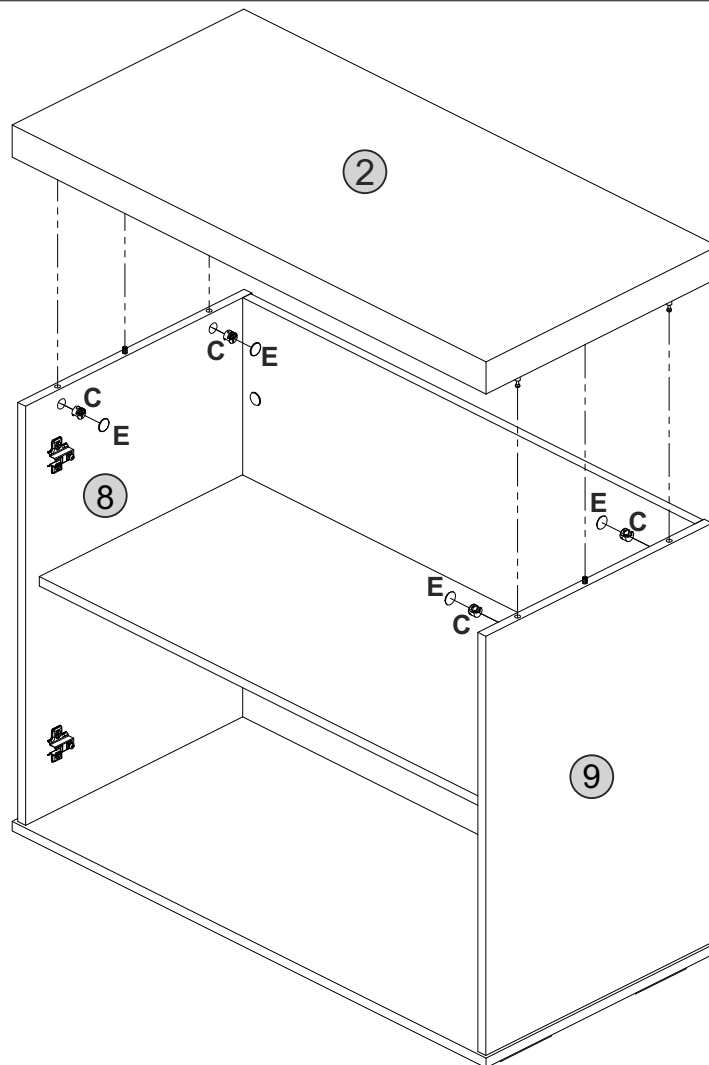

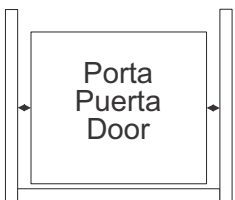
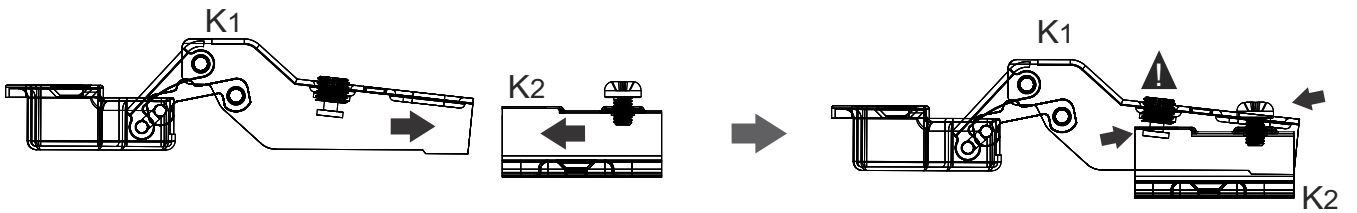
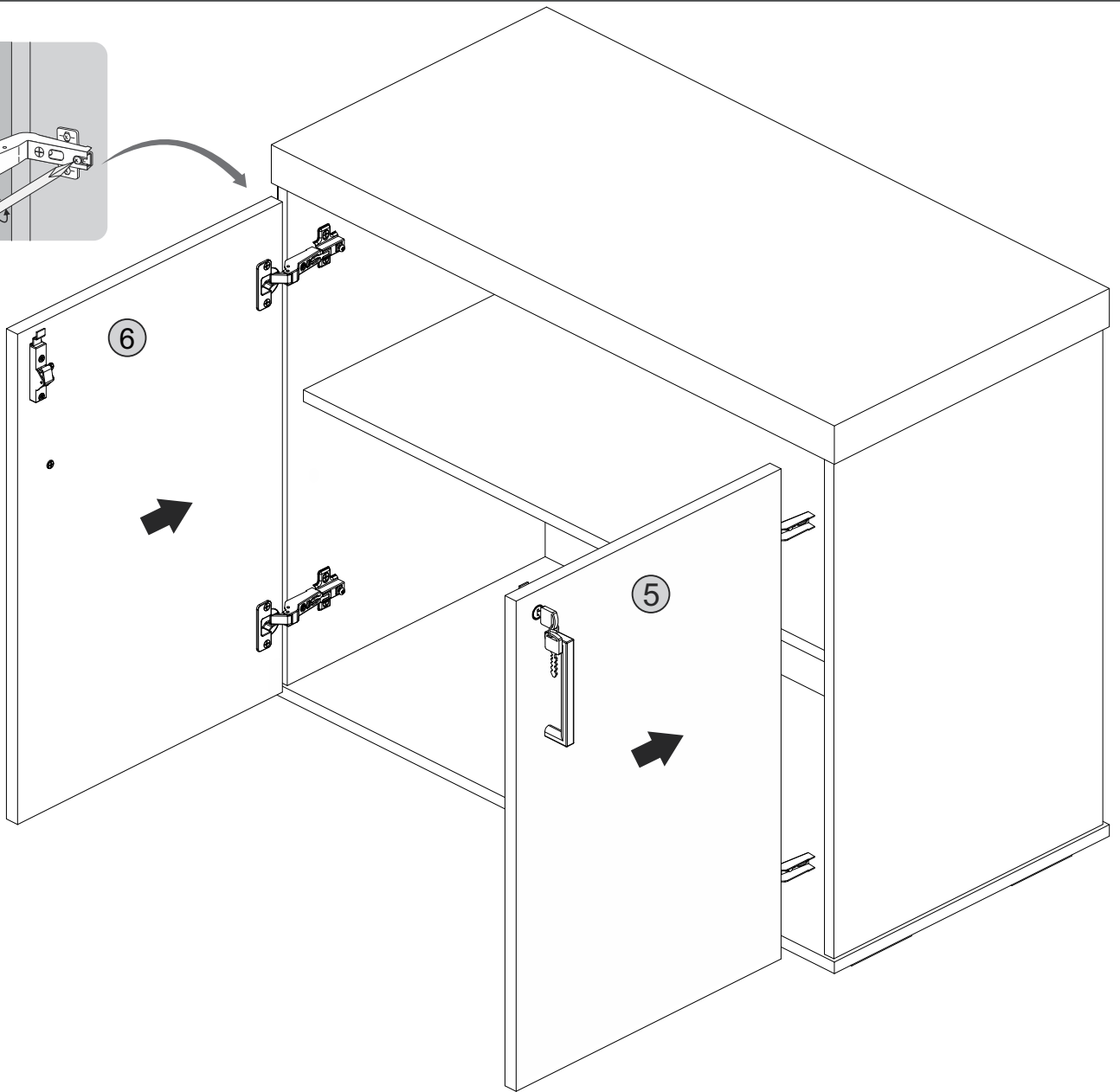
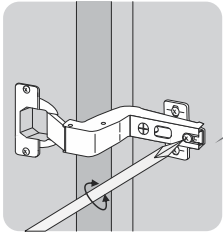

Porta  
Puerta  
Door

Ajuste de largura  
Ajuste de ancho  
Width adjustment



Porta  
Puerta  
Door

Ajuste interno  
Ajuste interno  
Internal adjustment



Porta  
Puerta  
Door

Ajuste de profundidade  
Ajuste de profundidad  
Depth adjustment

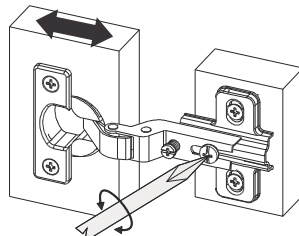
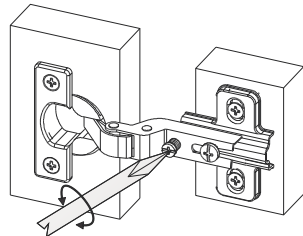
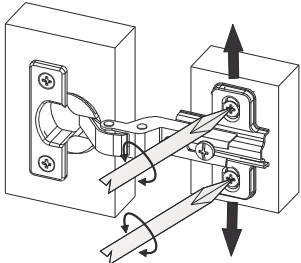

**!** Ajuste as portas com o piso plano.  
Ajustar las puertas en una superficie plana.  
Adjust the doors in a flat floor.

Como fechar a porta  
Cómo cerrar la puerta  
How to close the door

Aberto  
Abrir  
Open

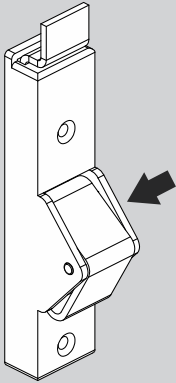

Fechado  
Cerrado  
Closed

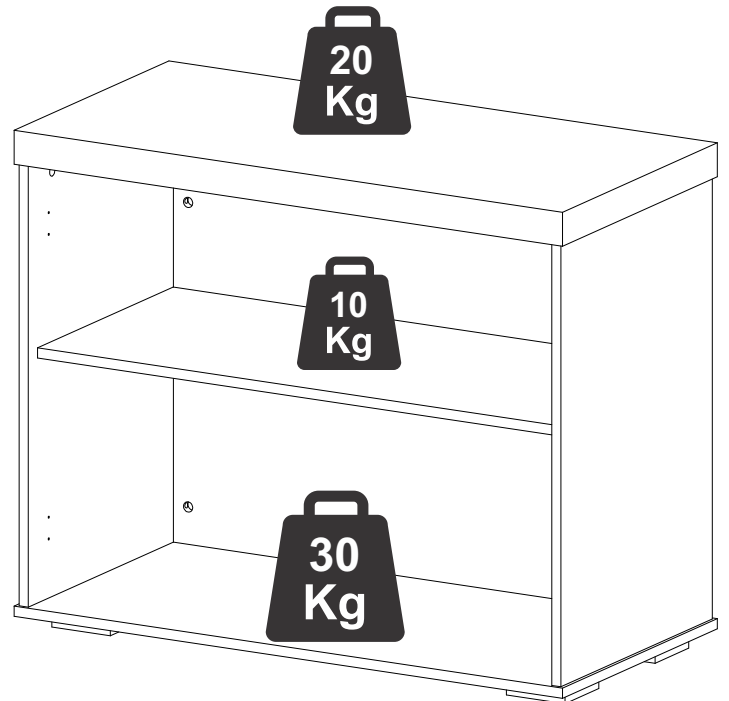
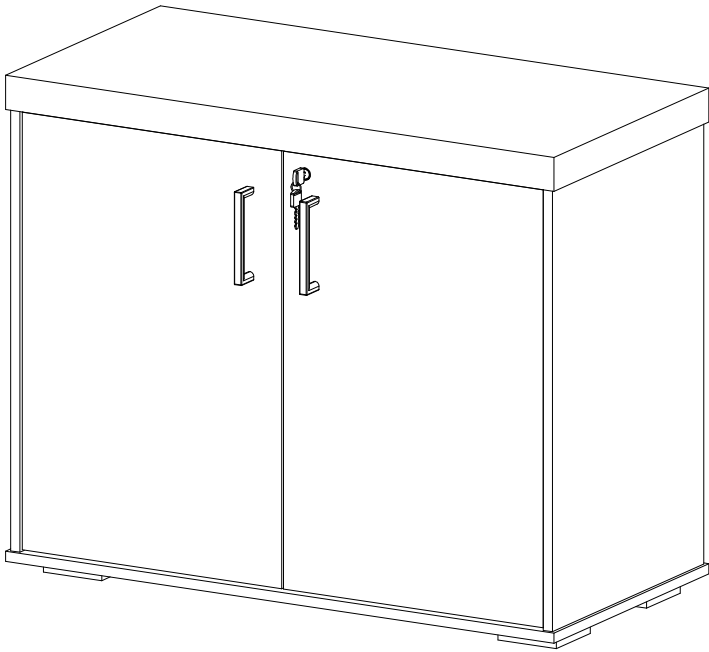
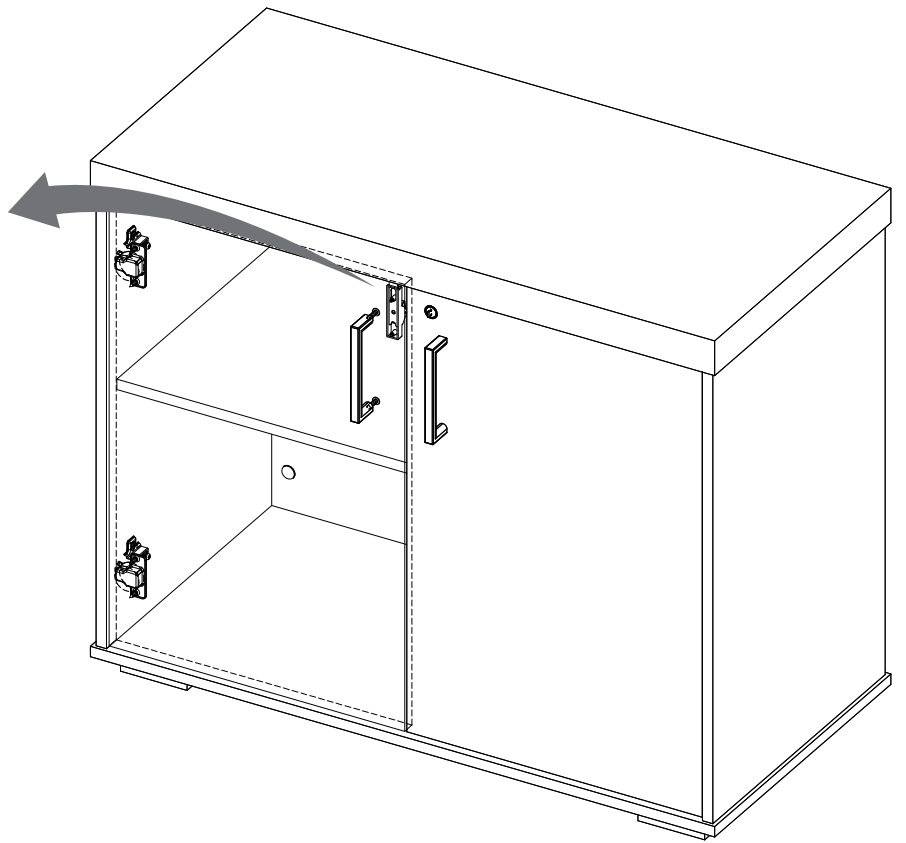
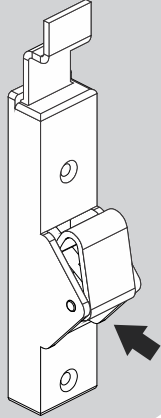

# Obrigado

POR SUA CONFIANÇA EM NOSSO TRABALHO!



Esperamos que sua experiência de compra, montagem e instalação tenha sido perfeita!

Desejamos que seu móvel possa tornar seu Home Office, casa ou escritório, um ambiente muito mais agradável e organizado, fazendo seu trabalho, estudo ou descanso ser muito mais proveitoso!

## APROVEITE SEU MÓVEL ARTANY!

Se tiver alguma dúvida, sugestão ou comentário, pode entrar em contato no nosso WhatsApp (41) 99242-8497, telefone (41)3556-1550, ou email [artany@artany.com.br](mailto:artany@artany.com.br)



Gostou? Compartilhe este momento e marque a gente!



@artanymoveis



# ARTANY®

Arte em Home Office