

1º PASSO: PREGAR AS SAPATAS NOS PÉS

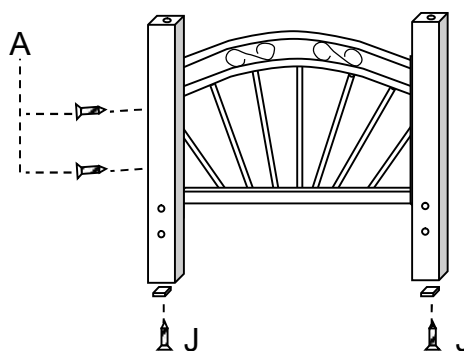

2º PASSO: UNIR O FRONTÃO E OS PÉS FORMANDO AS CABECEIRAS



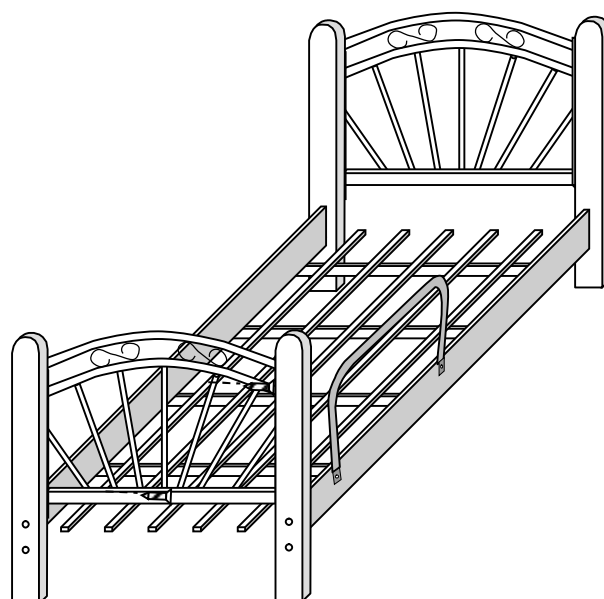
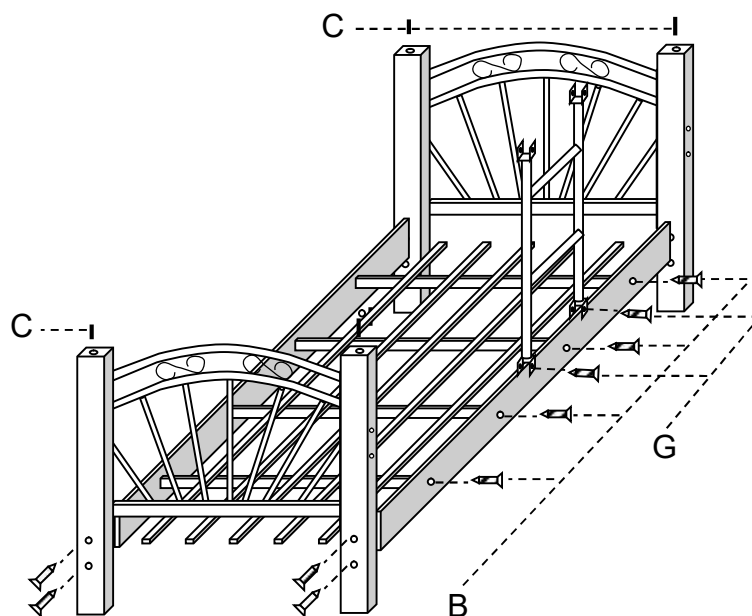

3º PASSO: MONTAR OS ESTRADOS COM AS BARRAS LATERAIS NO CHÃO

4º PASSO: PARAFUSAR AS BARRAS UNINDO AS CABECEIRAS E AS PESEIRAS

5º PASSO: PARAFUSAR A ESCADINHA E A GRADE DE PROTEÇÃO

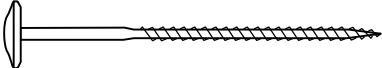
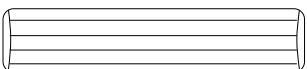
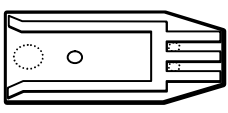
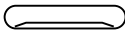

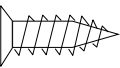
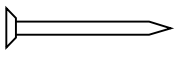
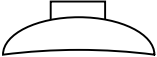
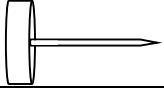
OBSERVAÇÃO: PROTEJA SEMPRE AS PEÇAS PARA NÃO RISCAR

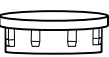
CÓD	DESENHO	QTD	NOME (ONDE USAR)
A		16	PARAFUSO ALLEN TAMPINHA ¼" X 77 PRETO
B		16	PARAFUSO PHS 4,5 X 50 FLANGEADO
C		4	CAVILHA 15 X 60
D		16	SUORTE SARRAFO
E		32	TAMPINHA CPL
F		16	PARAFUSO PHS TAMPINHA ¼" X 90
G		6	PARAFUSO 4 X 16
H		40	PREGO 8 X 8 – FIXAR AS RIPAS
I		16	PORCA MEIA LUA
J		4	SAPATA COM PREGO 30 x 15 x 6
K		16	PORCA SEXTAVADA
L		4	PONTEIRA 3/4" INTERNA – ACABAMENTO ESCADINHA
M		2	PONTEIRA 7/8" INTERNA – ACABAMENTO PROTEÇÃO

COD. PEÇA	QTD	DESCRIÇÃO DE PEÇAS	
1	4	PÉ	MDF 800 x 70 x 55
2	4	FRONTÃO	TUBO 850 x 530 x 35
3	4	BARRA	MDF 1900 x 130 x 20
4	8	SARRAFO	EUCALÍPITO 810 x 45 x 22
5	10	RIPA	PINUS 1850 x 70 x 10

**FERRAMENTAS NECESSÁRIAS
NÃO FORNECIDAS**
