

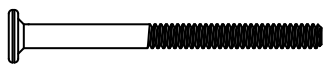







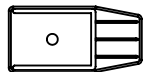

ESQUEMA DE MONTAGEM - BELICHE PEQUIM

Pág 1

CÓD	DESENHO	QTD	NOME (ONDE USAR)
A		16	PARAFUSO 1/4" x 110
B		16	PORCA MEIA LUA
C		17	PARAFUSO 7 x 110
D		16	PARAFUSO 4.5 X 50
E		16	SUPORTE DE SARRAFO
F		8	PREGO 8 X 8
G		32	PREGO 12 X 12
H		4	CAVILHA 15 X 60
I		4	SAPATA DOMINÓ
J		18	PARAFUSO 4.0 X 25

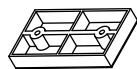
**PESO MÁXIMO SUPORTADO:
120Kg**

LISTA DE PEÇAS

Nº PEÇA	CÓD. IND.	DESCRIÇÃO	QTD.	DIMENSÕES (mm)		
				COMP.	LARG.	ESP.
1	4274	FRONTÃO SUPERIOR	04	845	170	15
2	4244	FRONTÃO INFERIOR	04	845	100	15
3	4232	PÉ INFERIOR	04	800	75	75
4	4231	PÉ SUPERIOR	04	800	75	75
5	4280	PAINEL	04	865	175	06
6	0379	BARRA	04	1900	130	20
7	2999	SARRAFO	08	900	45	22
8	3481	RIPA	08	1850	70	09
9	4279	PROTEÇÃO	01	1300	130	15
10	4276	LAT. MAIOR DA ESCADA	01	1220	80	15
11	4277	LAT. MENOR DA ESCADA	01	930	80	15
12	4278	DEGRAU DA ESCADA	02	450	80	15

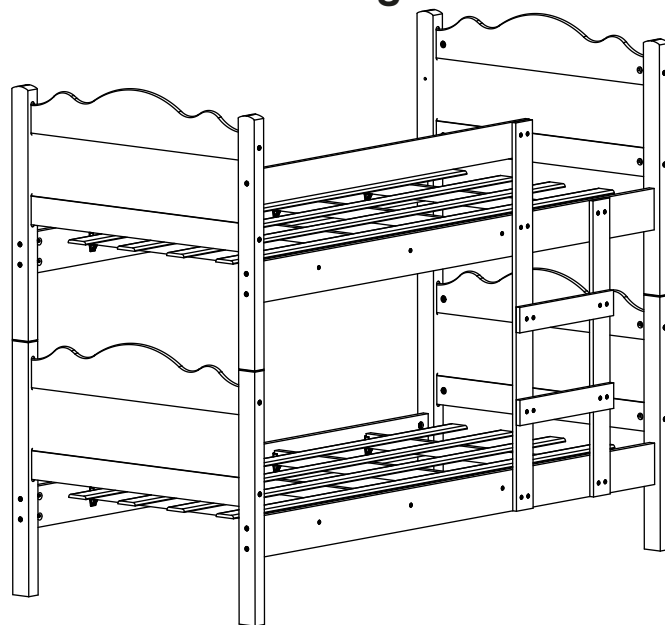

PRODUTO MONTADO: 2020 X 1600 X 950

ATENÇÃO

- 1-Ler e observar atentamente toda instrução antes de iniciar a montagem.
- 2-A montagem do produto deverá ser feita em superfície limpa e plana. Aconselhamos utilizar a embalagem para forrar o chão a fim de não danificar o produto.
- 3-Os parafusos devem ser apertados periodicamente.
- 4-Evitar batidas e contatos com objetos cortantes.

LIMPEZA

- 1-Pano levemente umedecido com água, seguido de pano seco.
- 2-Não utilizar produtos químicos ou abrasivos.



1 PESSOA



ESQUEMA DE MONTAGEM - BELICHE PEQUIM

Pág 2

ATENÇÃO SR. MONTADOR: PARA EVITAR AVARIAS AO PRODUTO QUANDO MONTADOS COM PARAFUSADEIRAS O MESMO DEVERÁ SER MONTADO COM TORQUE BAIXO.

