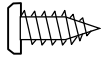
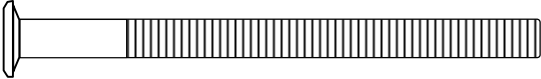
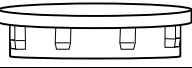
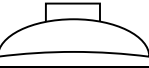
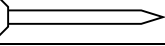
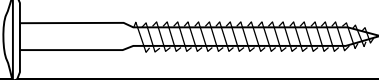
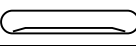
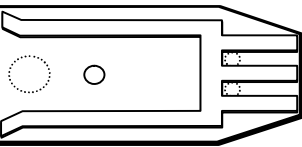

ESQUEMA DE MONTAGEM – CAMA CASAL SEVILHA (2 Volumes)

Pág 1

RELAÇÃO DE FERRAGENS (ESCALA 1 X 1)			
CÓD	DESENHO	QTD	NOME (ONDE USAR)
A		16	Paraf.4,0 x 14- PHS - Fixar os Painéis na Cabeceira e Peseira
B		08	Paraf.1/4" x 70- PHS - Fixa o Cabeceira e Peseira nas Barras
C		04	Ponteira 32X32X17 - Pés
D		08	Porca Meia Lua – Fixar as Barras na Cabeceira e Peseira
E		70	Prego 12 x 12 - Fixa Ripas
F		12	Paraf 4,5 x 50 - PHS – Fixa os Sarrafos
G		08	Tampinha de Acabamento
H		12	Selo de Barra plástica 60 x 32 x 30 – Fixa Sarrafos nas Barras Laterais

DESCRIÇÃO DE PEÇAS			
CÓDIGOS DAS PEÇAS	QTD	NOME	DETALHES
1	1	Cabeceira	Tubo 1025 x 1480 x 32 mm
2	1	Peseira	Tubo 610 x 1480 x 32 mm
3	2	Painel da Cabeceira	MDP 622 x 220 x 12 mm
4	2	Painel da Peseira	MDP 250 x 220 x 12 mm
5	2	Barra	MDF 1900 x 135 x 20 mm
6	6	Sarrafo	Eucalipto 1420 x 40 x 20 mm
7	10	Ripa	MDF 1850 x 70 x 10 mm

PESO MÁXIMO SUPORTADO:
240 KG

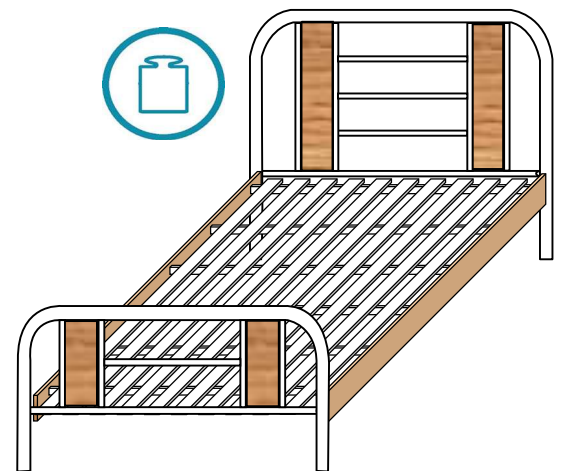

PRODUTO MONTADO

Ferramentas Necessárias
(Não Fornecidas)

DIMENÇÕES DO PRODUTO MONTADO 1020 X 1450 X 1870 MM

ATENÇÃO:

- 1-Ler e observar atentamente toda instrução antes de iniciar a montagem.
- 2-A montagem do produto deverá ser feita em superfície limpa e plana. Aconselhamos utilizar a embalagem para forrar o chão a fim de não danificar o produto.
- 3-Os parafusos devem ser apertados periodicamente.
- 4-Evitar batidas e contatos com objetos cortantes.

LIMPEZA:

- 1-Pano levemente umedecido com água, seguido de pano seco.
- 2-Não utilizar produtos químicos ou abrasivos.



1 PESSOA

ESQUEMA DE MONTAGEM – CAMA CASAL SEVILHA (2 Volumes)

Pág 2

MONTANDO PASSO A PASSO

1º PASSO: COLOCAR AS SAPATAS NOS PÉS E FIXAR OS PAINEIS NA CABECEIRA E PESEIRA



PARAF. 4,0 x 14
CÓD: A
QTD: 16

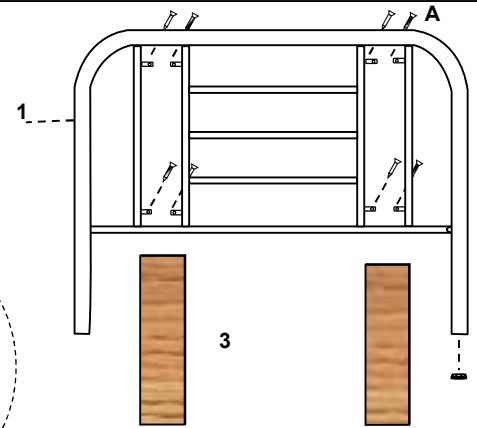
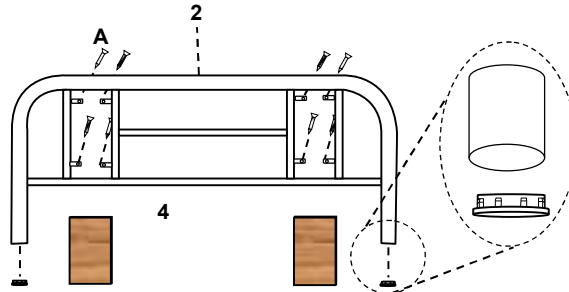

SAPATA
CÓD: C
QTD: 04



3º PASSO: PARAFUSAR AS BARRAS UNINDO CABECEIRA E PESEIRA

4º PASSO: FIXAR OS SARRAFOS NAS BARRAS

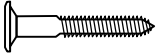
PARAFUSO 1/4" X 70
CÓD: B
QTD: 08



PARAFUSO 4,5 X 50
CÓD: F
QTD: 12

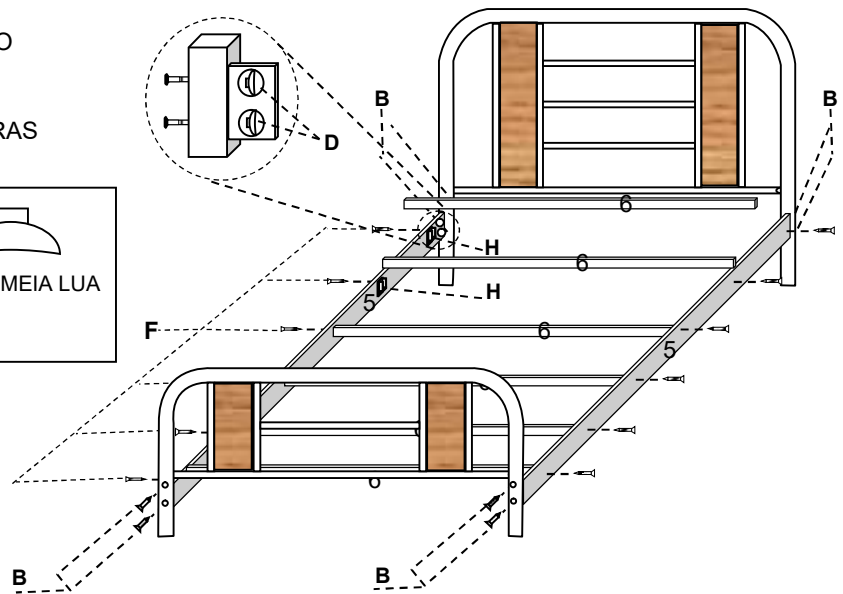

PORCA MEIA LUA
CÓD: D
QTD: 08

SELO DE BARRA
CÓD: H
QTD: 12

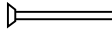

5º PASSO: FIXAR AS RIPAS E COLOCAR AS TAMPINHAS DE ACABAMENTO

PREGO 12 X 12
CÓD: E
QTD: 70

TAMPINHA DE ACABAMENTO
CÓD: G
QTD: 08

