



Rodovia SC-492 - Km 10 - B. Industrial
89905-000 - Bandeirante - SC
Fone: (49) 3622-4549
e-mail: mxmoveis@mxmoveis.com.br



Ref. CO008

Cômoda
Cômada
Oslo

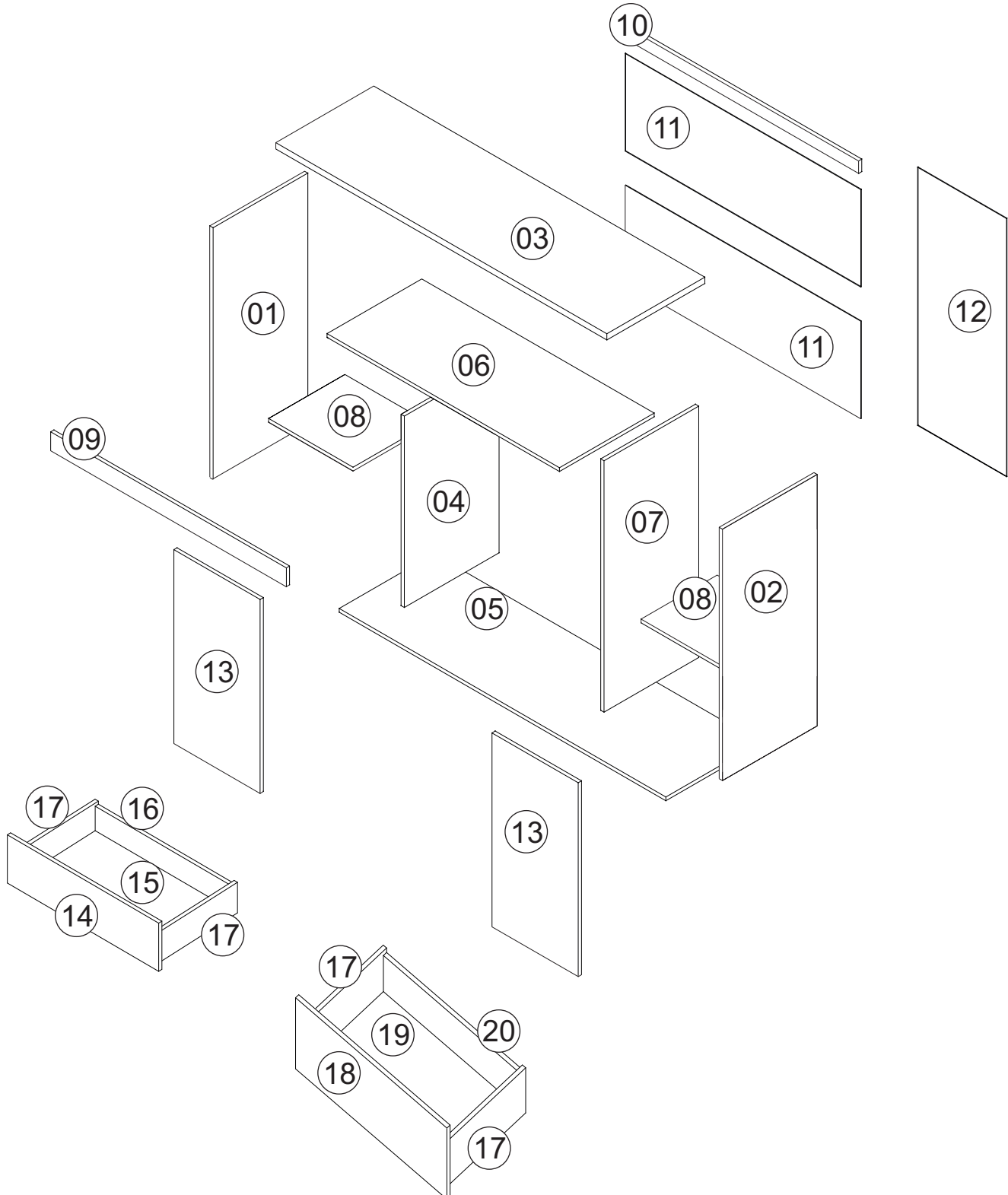

Nº	CÓDIGO	NOME DA PEÇA/DESCRIPCIÓN PIEZAS	MEDIDAS (mm)	QTD.	NOGAL	HAVANA	TAUPE	OFF WHITE	MARROCOS
01	CO008.18.00	Lateral externa esquerda/Lateral izquierda	1000x435x15	01	154167	103828	115129		188637
02	CO008.17.00	Lateral externa direita/Lateral derecha	1000x435x15	01	154168	91909	115111		188637
03	CO008.33.00	Tampo/Tapa	1520x460x25	01	176983	176847	176866		188615
04	CO008.22.01	Lateral interna/Lateral	761x435x15	01	167122	167117	167119		188635
05	CO008.01.00	Base inferior/Base inferior	1500x435x15	01	154145	89373	115133		183612
06	CO008.04.00	Base Sob gaveta/base cajón	1067x435x15	01	154171	89334	115107		188641
07	CO008.22.00	Lateral interna/Lateral	1000x435x15	01	154166	89368	115130		188636
08	CO008.02.00	Base interna/Base interna	388x350x15	02	87466	87466	87466		87466
09	CO008.12.00	Ripa envoltório/Ripa	1067x75x15	01	154169	89336	115109		188639
10	CO008.28.00	Ripa sustentação/Ripa	1067x50x15	01	87468	87468	87468		87468
11	CO008.13.01	Forro/Revés	1085x390x2,5	02	89375	89375	89375		89375
12	CO008.13.00	Forro/Revés	1027x408x2,5	01	89374	89374	89374		89374
13	CO008.25.00	Porta /Puerta	771x400x15	02	154147	89371		115131	188614
14	CO008.14.00	Frente gaveta/Frente cajón	674x190x15	04	172694	172704		172712	188613
15	CO008.34.00	Forro Gaveta/Revés cajón	626x355x2,5	04	87473	87473	87473		87473
16	CO008.29.00	Ripa traseira gaveta/Trasero cajón	616x100x12	04	89370	89370	89370		89370
17	CO008.15.00	Lateral gaveta/Lateral cajón	350x120x12	10	87470	87470	87470		87470
18	CO008.14.01	Frente gaveta/Revés cajón	402x221x15	01	172699	172708		172716	188640
19	CO008.34.01	Forro gaveta/Revés cajón	347x355x2,5	01	89369	89369	89369		89369
20	CO008.29.01	Ripa traseira gaveta/Trasero cajón	337x100x12	01	87471	87471	87471		87471

Ferragens/Herrajes

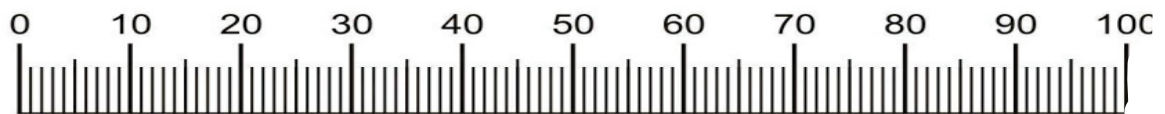
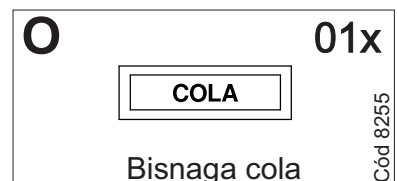
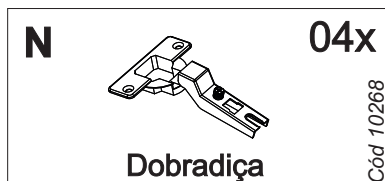
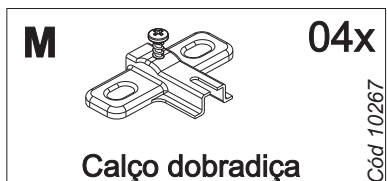
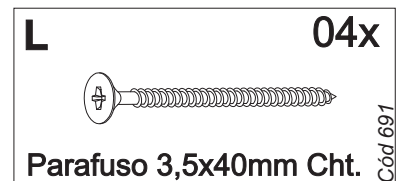
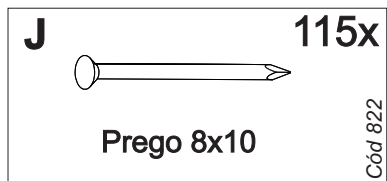
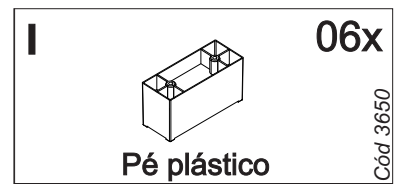
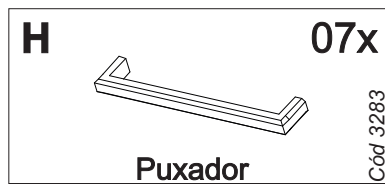
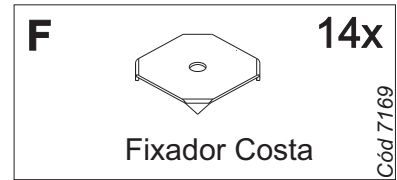
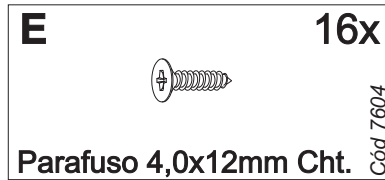
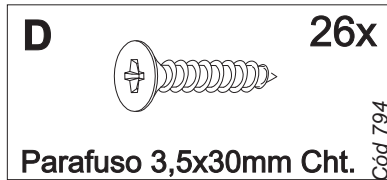
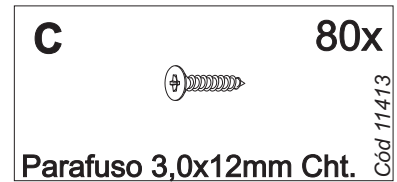
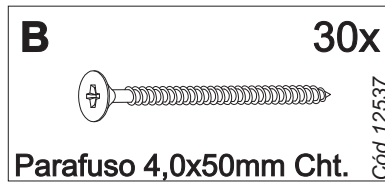
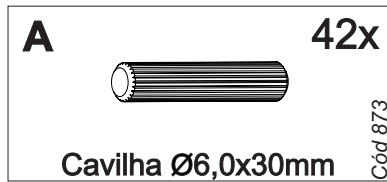

Medidas em mm

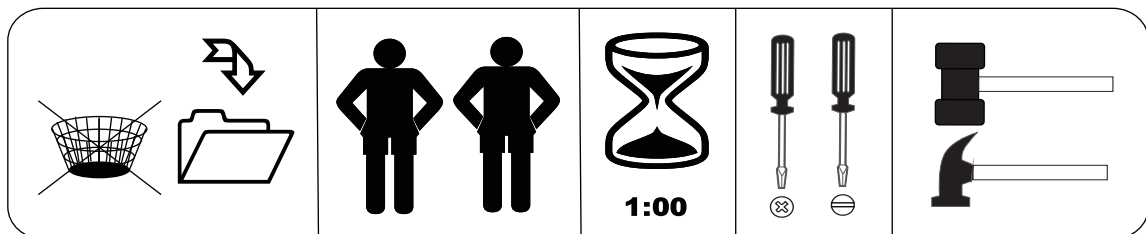

Produto para ser aplicado em caso de riscos na superfície

Pré-Montagem/Preparación Piezas

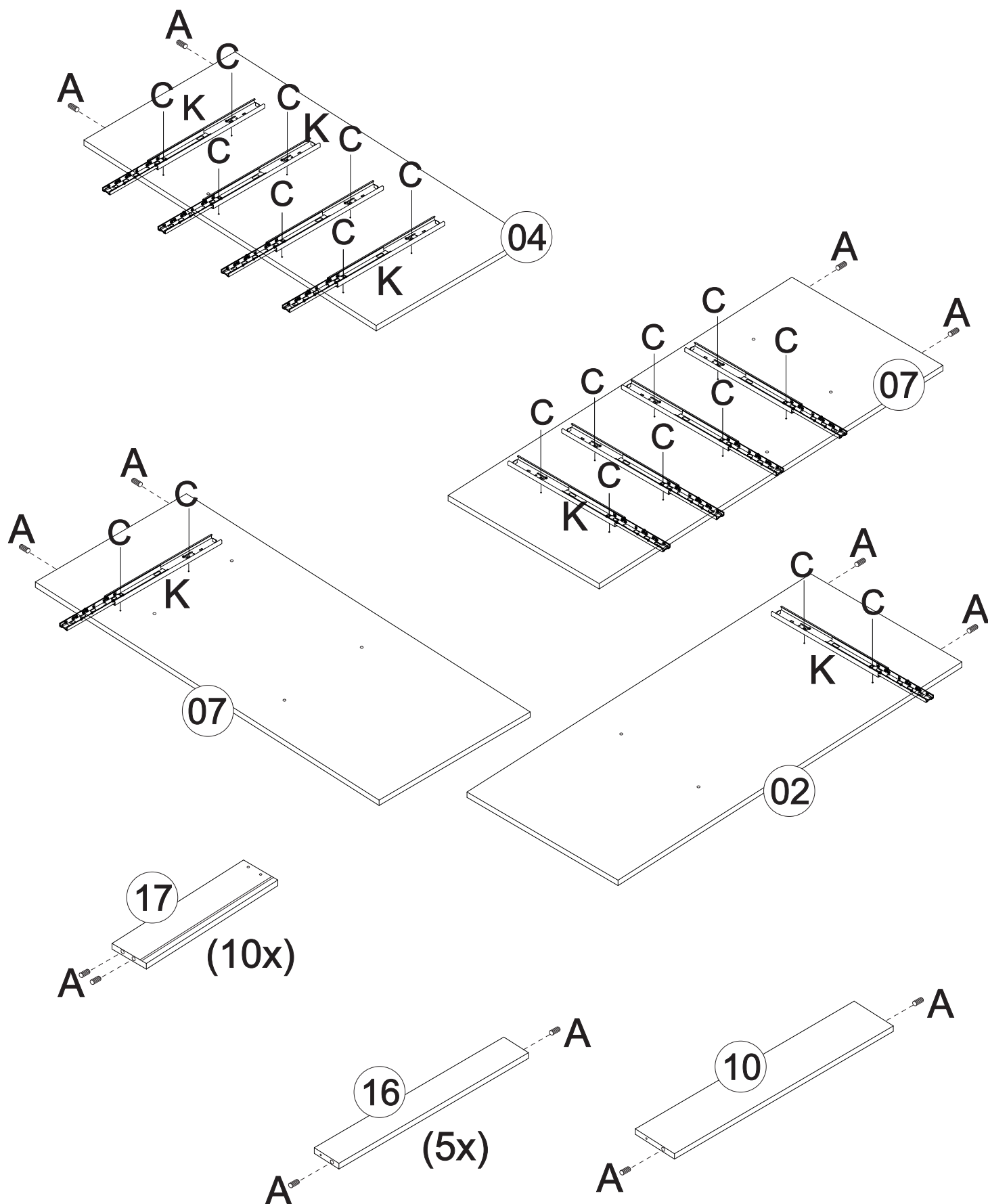

Montagem/Montaje

01

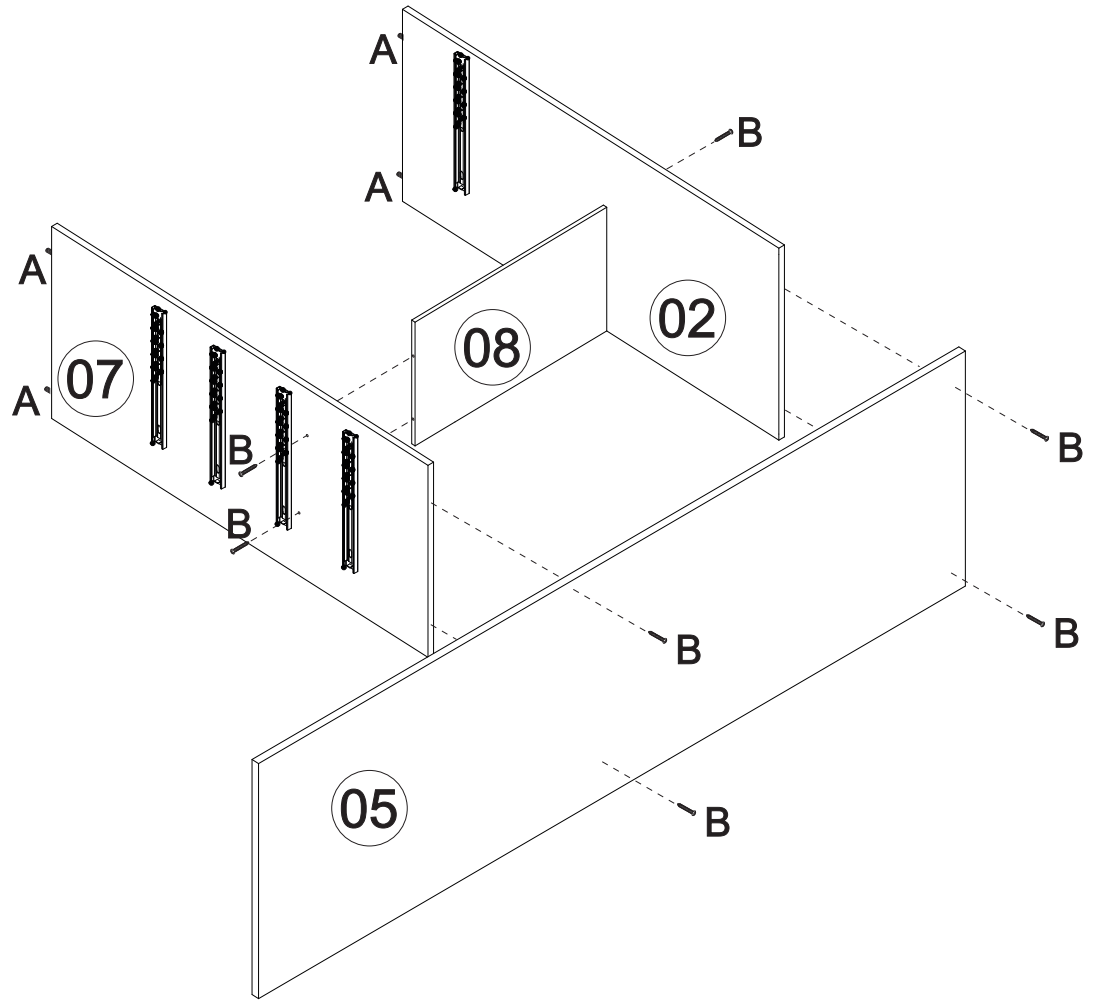

02

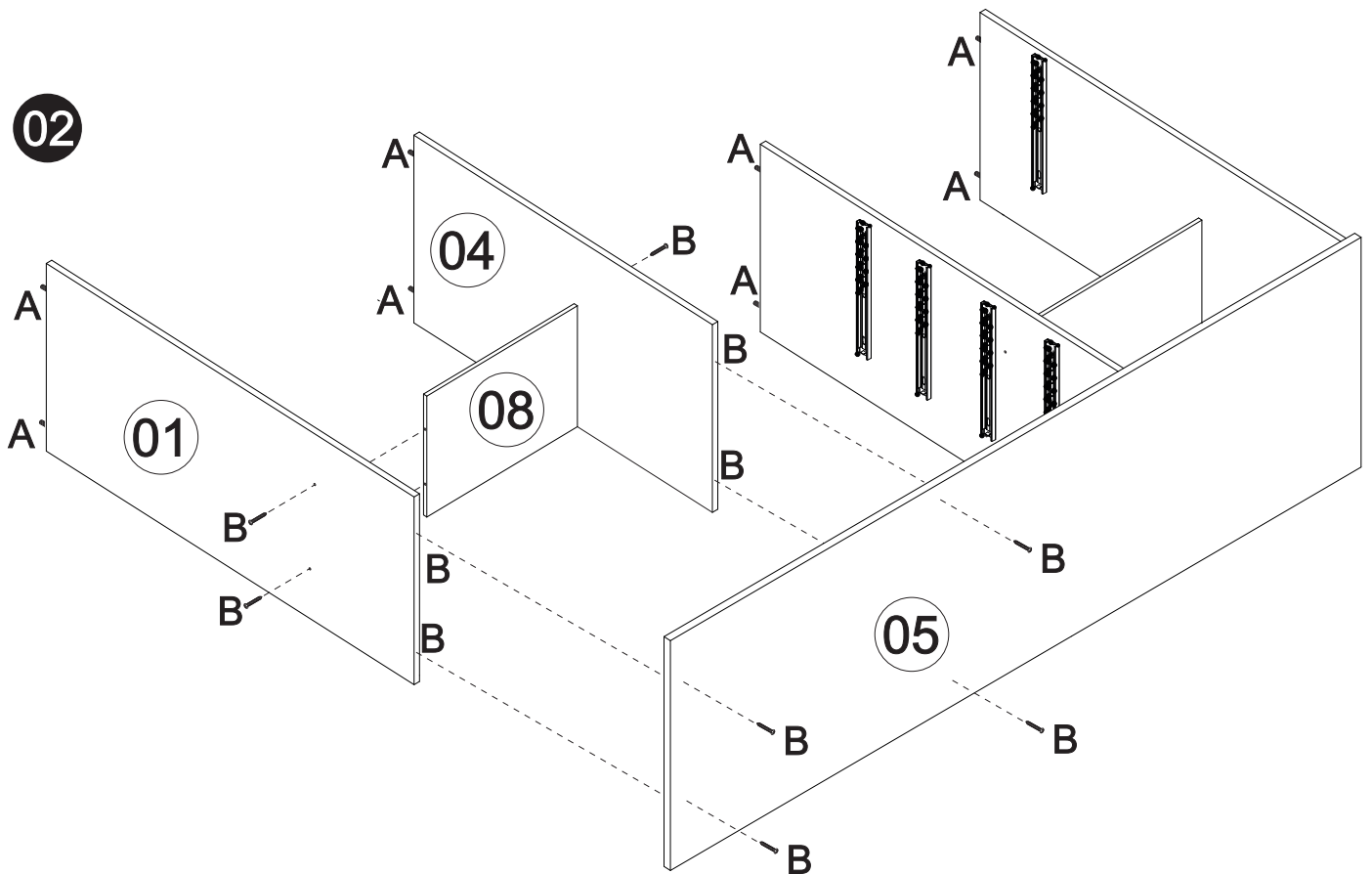

Montagem/Montaje

03

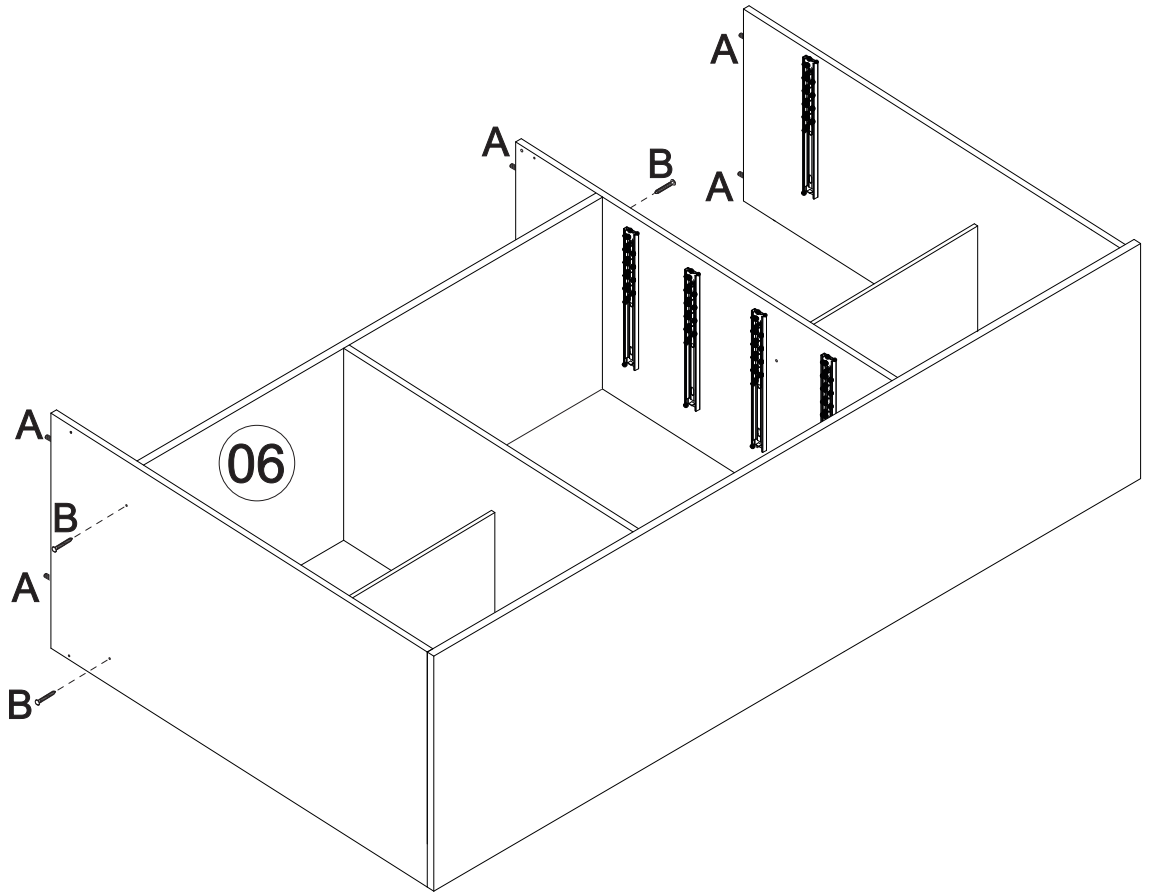

04

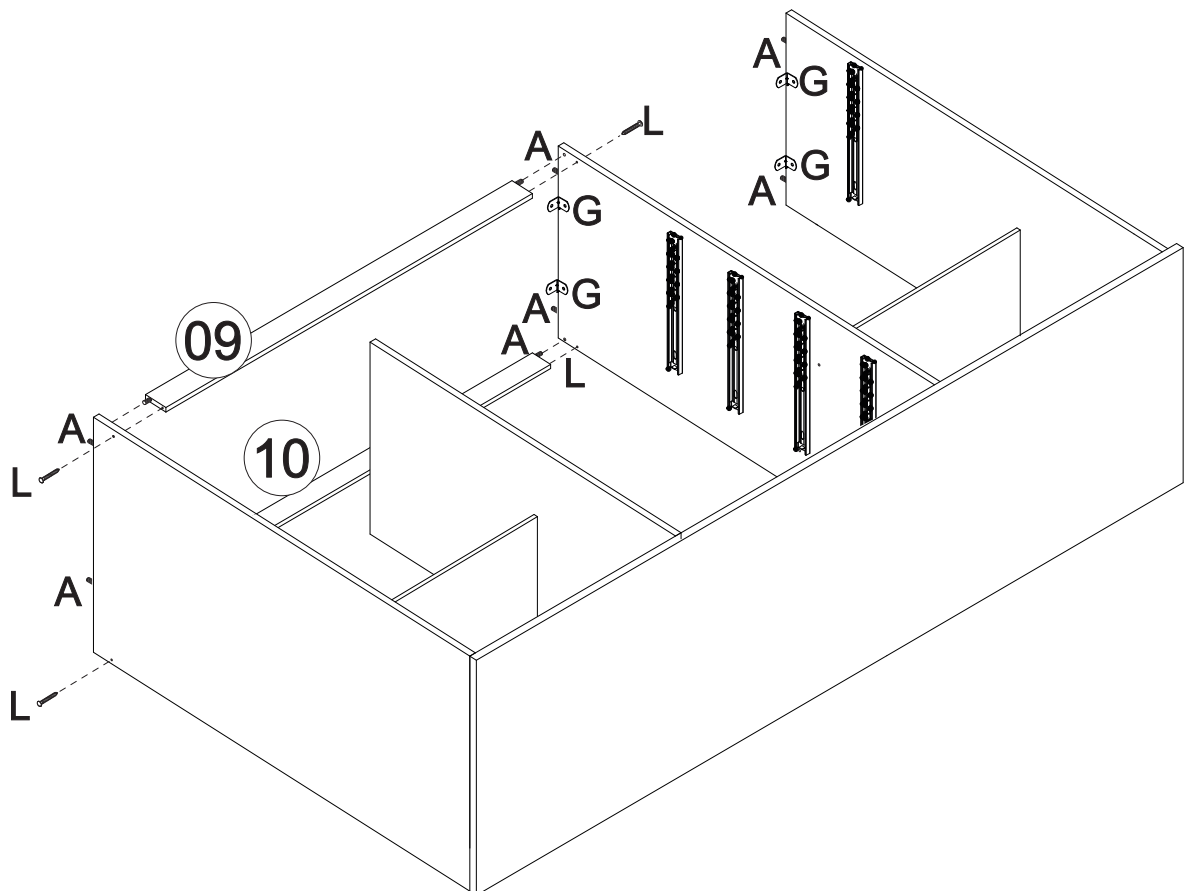

Montagem/Montaje

05

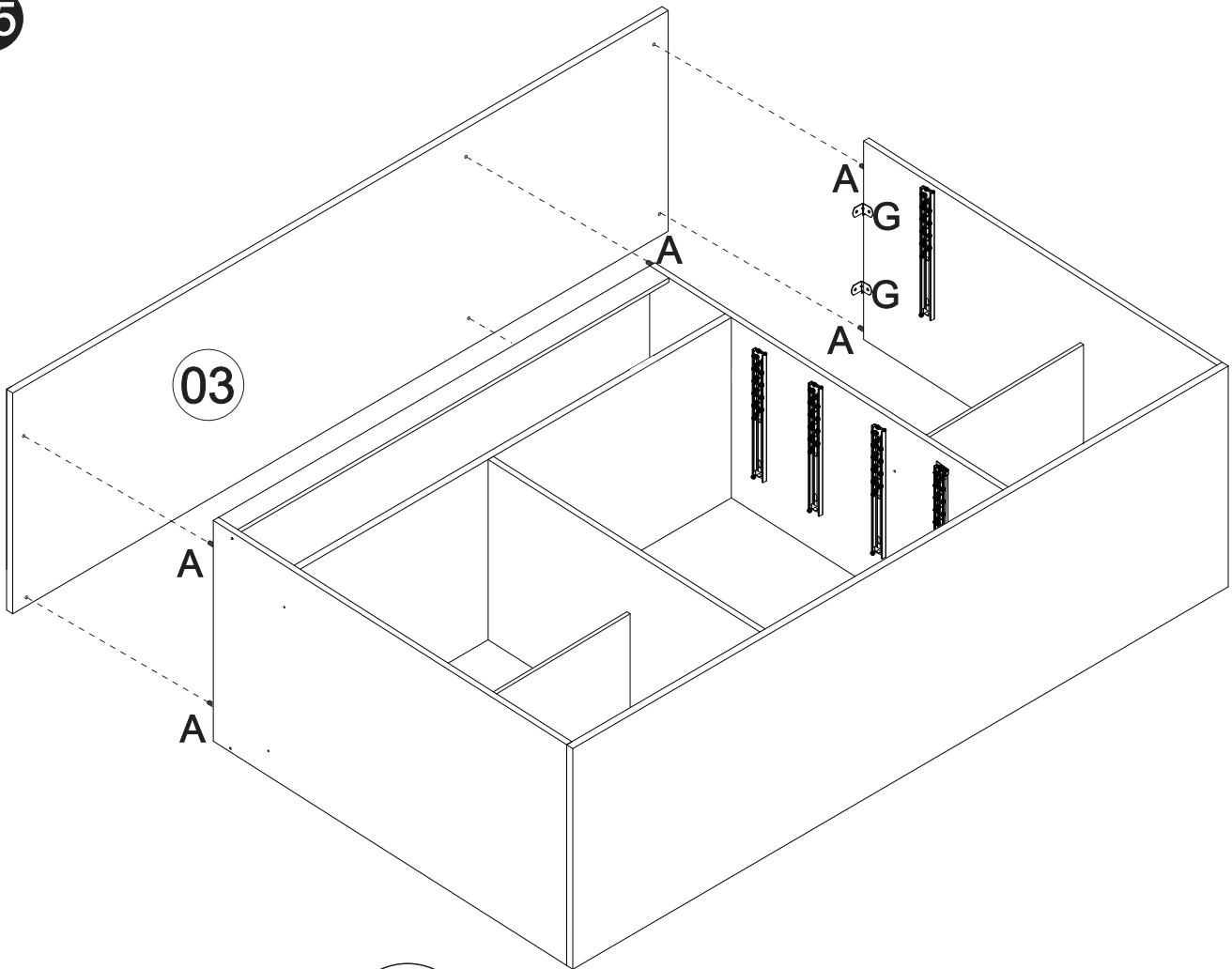

06

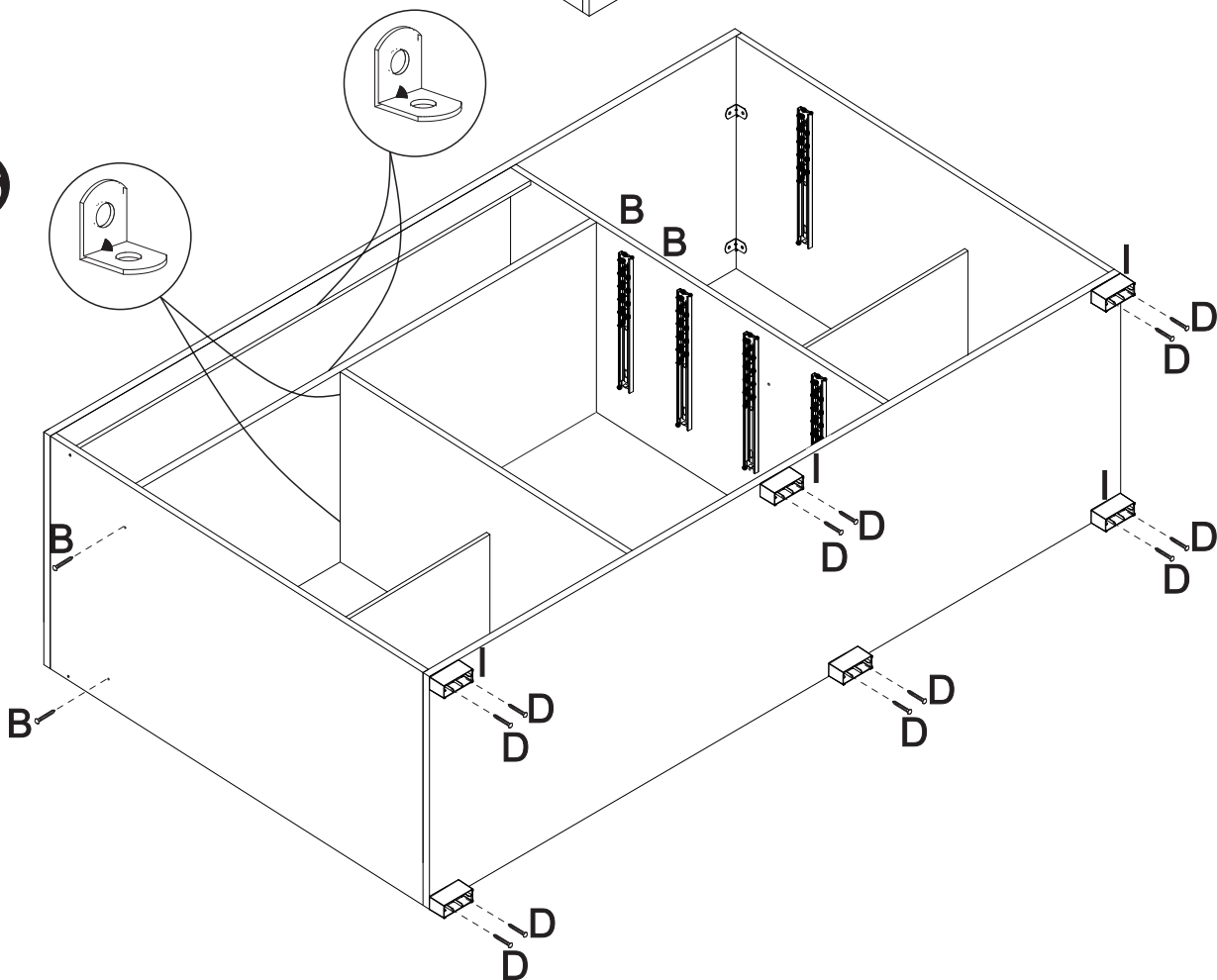

Montagem/Montaje

07

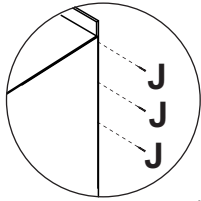

*Colocar um prego (J) a cada 100mm.

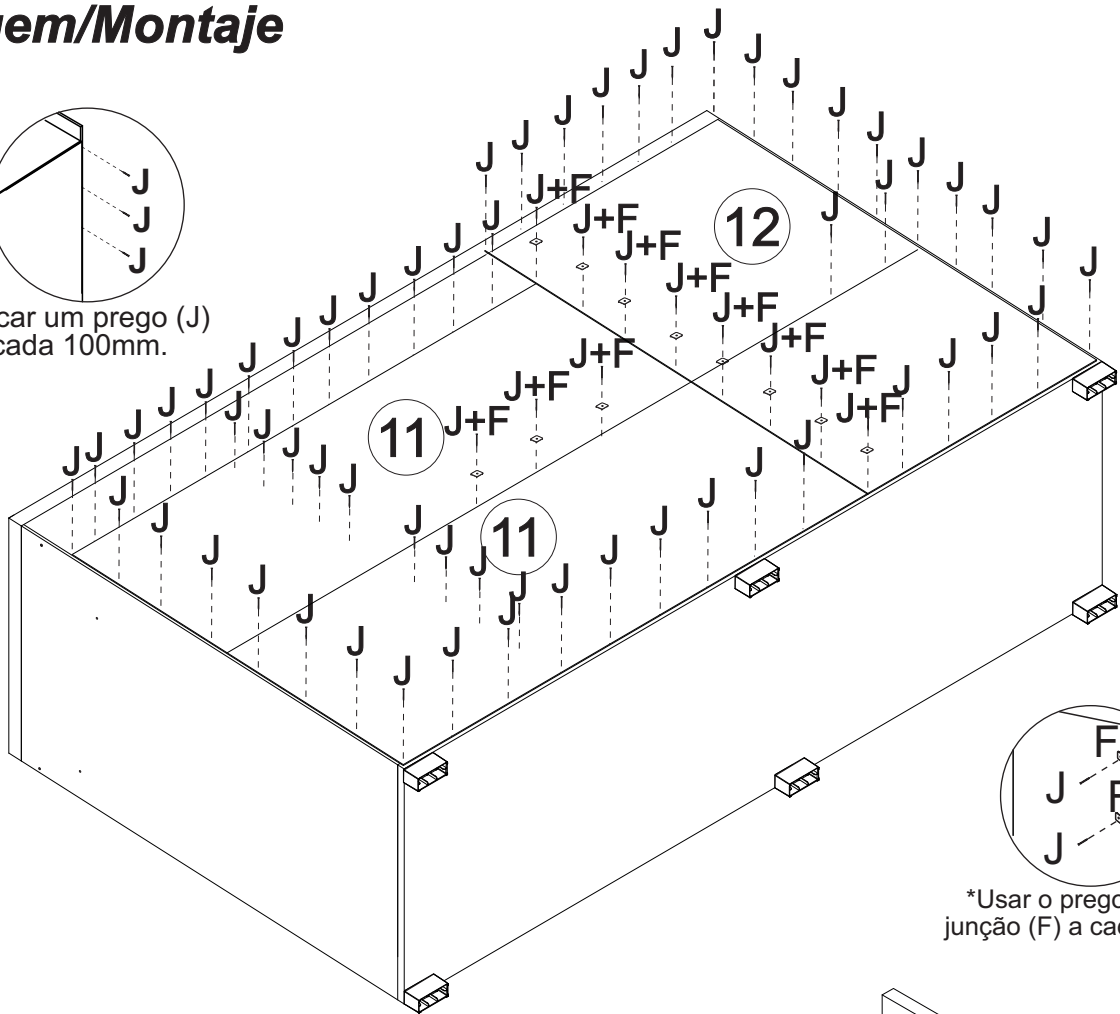

*Usar o prego (J) e a junção (F) a cada 100mm.

08 Montagem/Montaje

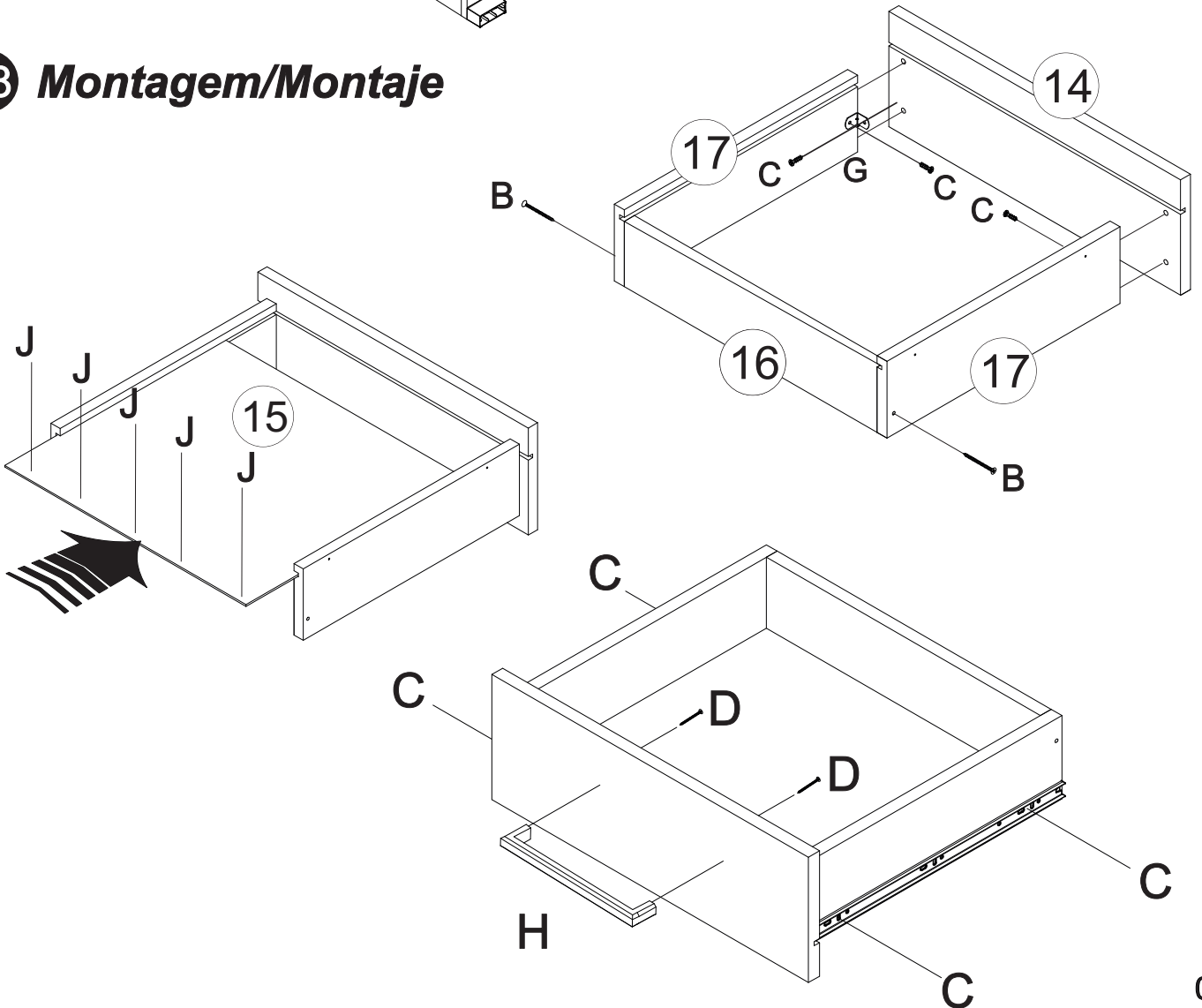

09

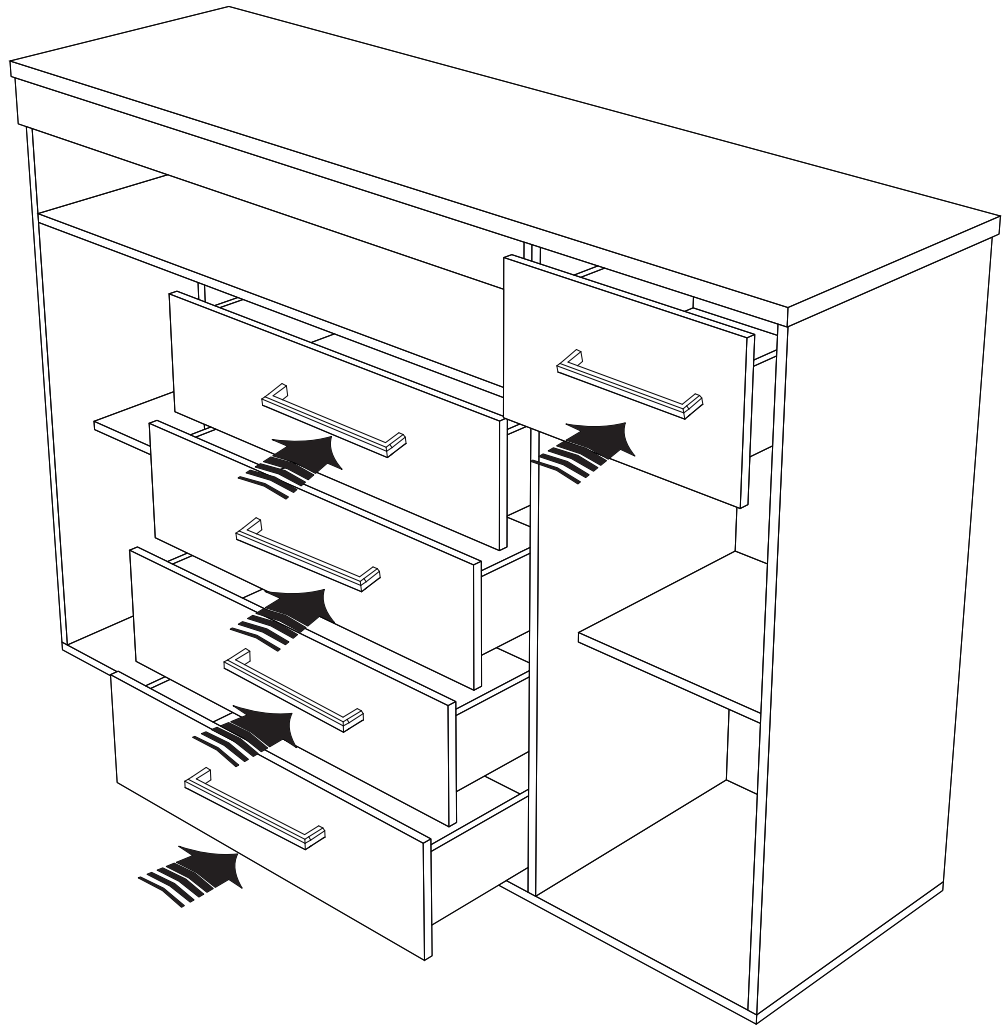

08

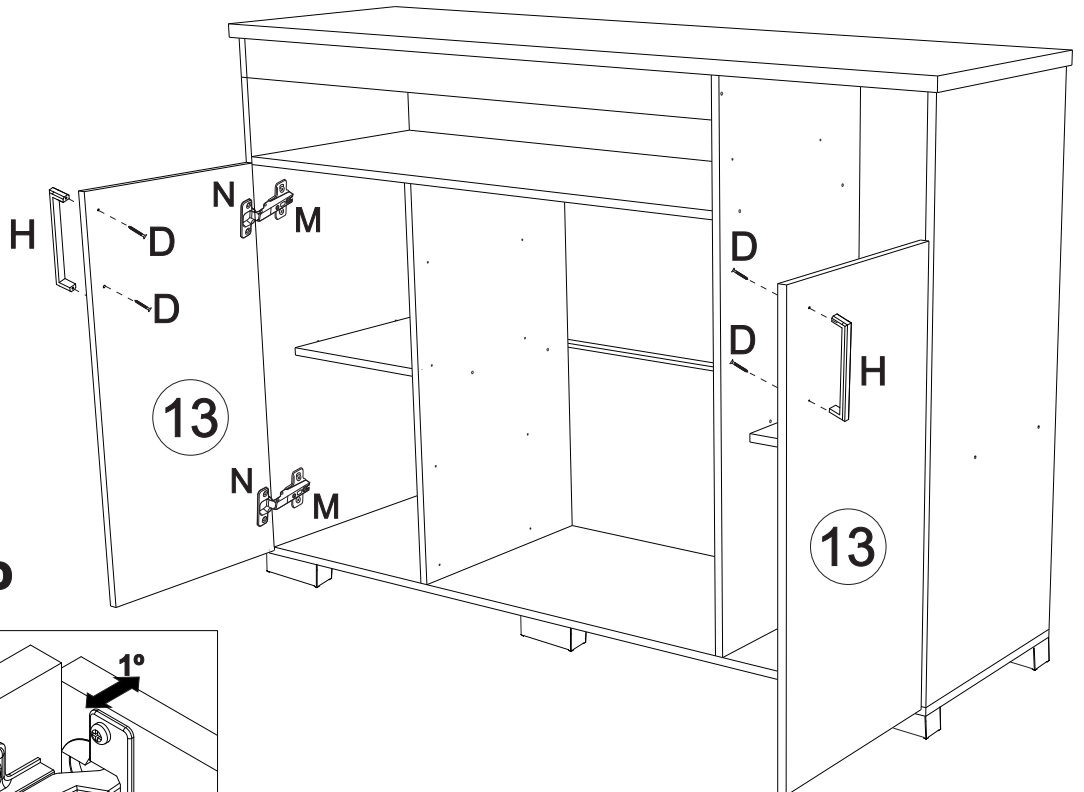
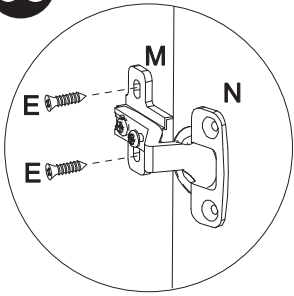

1°

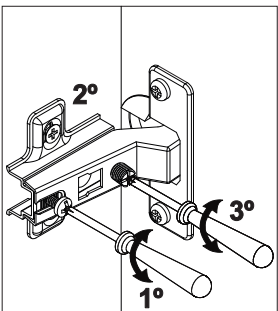

2°

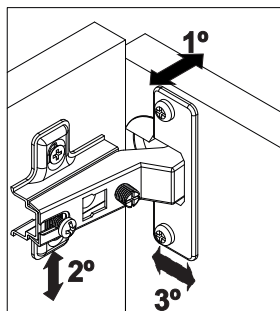

Montagem/Montaje

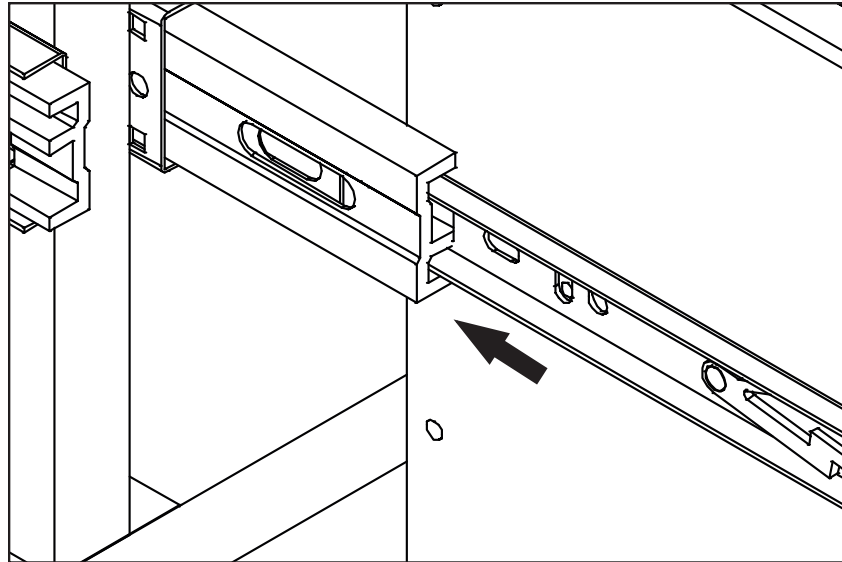

Para retirar parte da corrediça - para fixar nas laterais das gavetas - é necessário movimentar o aplicador de plástico que encontra-se no verso da mesma.

PASSO 1: Mover o aplicador para cima e segurar, ao mesmo tempo puxe a parte removível da corrediça. Segue exemplo:

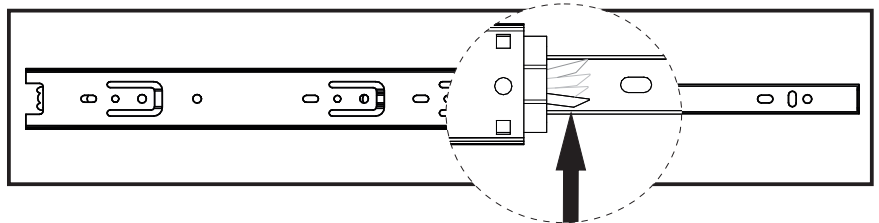

PASSO 2: Após fixo nas gavetas e nas laterais do móvel, encaixar a gaveta nas corrediças fixas nas laterais, empurrando-a.

Espaço livre na vertical: Retire a gaveta, desparafuse a corrediça na lateral direita e esquerda da gaveta. Regule conforme a necessidade e parafuse novamente. Coloque novamente a gaveta no móvel, caso a folga esteja correta favor retirar novamente a gaveta e aplicar mais (dois) 2 parafuso na corrediça, usando o furo fixo conforme desenho abaixo.

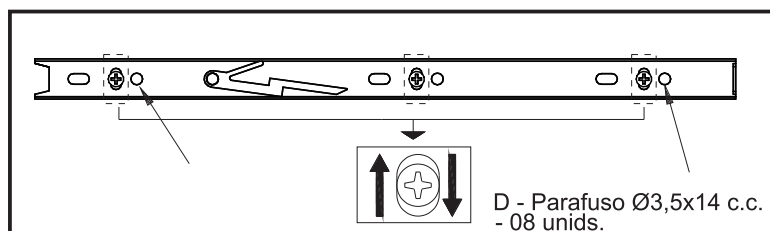

Espaço livre na horizontal: Retire a gaveta, desparafuse a corrediça na lateral do móvel, regule conforme a necessidade e parafuse novamente. Coloque novamente a gaveta no móvel, caso a folga esteja correta favor retirar novamente a gaveta e aplicar mais (dois) parafuso na corrediça, usando o furo fixo conforme desenho.

