

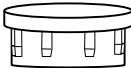

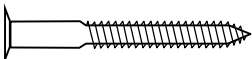







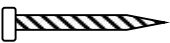

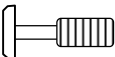
ESQUEMA DE MONTAGEM – CÔMODA SEVILHA C/ 4 GAVETAS (02 VOL)

Pág 1

INSTRUÇÃO DE MONTAGEM 1

RELAÇÃO DE FERRAGENS			
CÓD	DESENHO	QTD	NOME (ONDE USAR)
A		8	Ponteira 7/8" interna "Acabamento"
B		12	Paraf 4,5x50-Fixar as Laterais e as Gavetas.
C		32	Paraf 3,5 x 10 – Fixar as Corrediças
D		8	Paraf 4,0 x 25 – Fixar os Pés
E		30	Prego 8 x 8 – Pregar o Fundo
F		12	Parafuso mini-fixo – Unir Gavetas e Bases
G		12	Porca giro-fixo - Unir Gavetas e Bases
H		40	Cavilha 6x30 - Unir Gavetas e Bases
I		4	Arruela – Para Gaveta
J		4	Parafuso 3/16" x 5/8" – Para Gaveta
K		4	Espelho do Puxador – Para Gaveta
L		4	Puxador - Para Gaveta
M		4	Par de corrediça

RELAÇÃO DE PEÇAS DA CÔMODA			
CÓDIGOS PEÇAS	QTD	NOME	DETALHES
1	1	TAMPO SUPERIOR	630 x 430 x 15 mm
2	1	BASE (4 Furo passante)	630 x 430 x 15 mm
3	1	LATERAL ESQUERDA	815 x 430 x 15 mm
4	1	LATERAL DIREITA	815 x 430 x 15 mm
5	4	FRENTE DA GAVETA	552 x 200 x 15 mm
6	4	LATERAL ESQUERDA DA GAVETA	380 x 120 x 15 mm
7	4	LATERAL DIREITA DA GAVETA	380 x 120 x 15 mm
8	4	CONTRA FUNDO	532 x 120 x 15 mm
9	4	FUNDO DA GAVETA	515 x 392 x 2.8 mm
10	1	FUNDO DO CÔMODA	835 x 585 x 2.8 mm

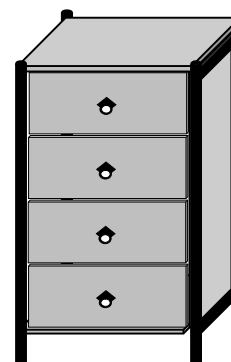

DIMENSÕES DO PRODUTO MONTADO: 990 X 650 X 470 MM



1 PESSOA



INSTRUÇÃO DE MONTAGEM 2

MONTANDO PASSO A PASSO

1º PASSO: COLOCAR AS CORREDIÇAS NAS LATERAIS DA CÔMODA E PARAFUSAR O TAMPO.

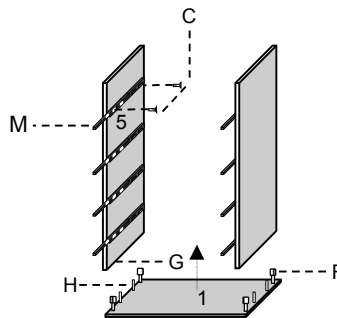
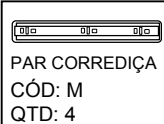
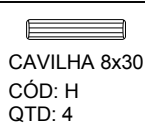
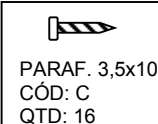
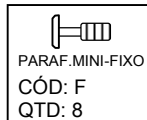

AS PEÇAS DA CÔMODA SÃO PRÉ MARCADAS E PRÉ FURADAS PARA FACILITAR A MONTAGEM

AS PORCAS GIROFIX QUE UNEM A BASE SUPERIOR NÃO VÃO TAPA FURO DE ACABAMENTO POIS AS GAVETAS TAMPAM

2º PASSO: VIRE O CRIADO PARA FIXAR A BASE
OBS: CUIDADO PARA NÃO RISCAR A CÔMODA

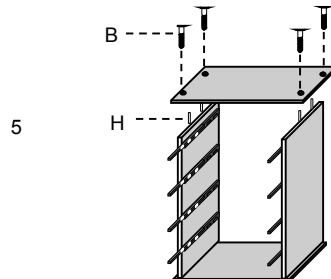
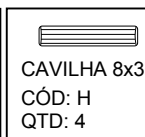
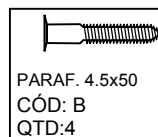

CUIDADO PARA NÃO RISCAR AS PEÇAS AO ENCAIXAR OS PARAFUSOS.

3º PASSO: COLOCAR PONTEIRAS DE ACABAMENTO E PARAFUSAR OS PÉS

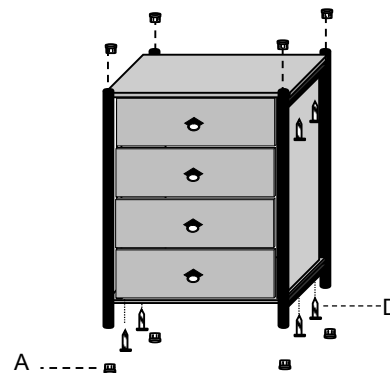
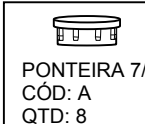
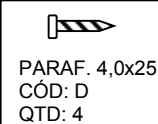

4º PASSO: MONTAGEM DAS GAVETAS.

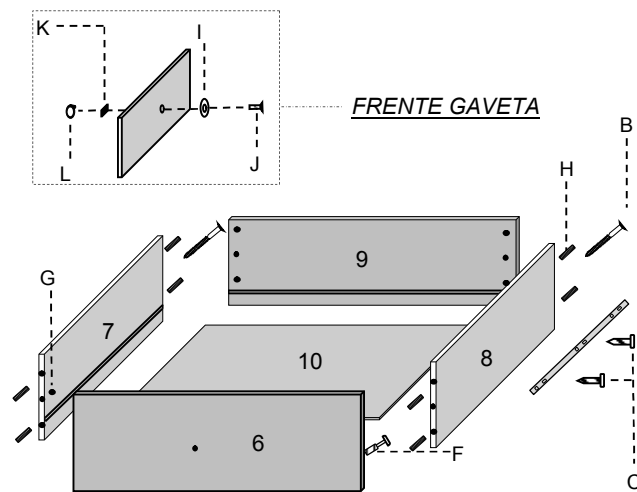
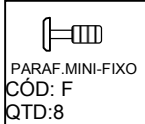
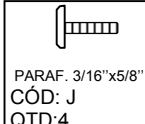
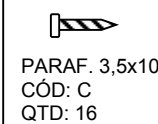
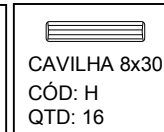
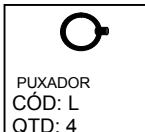
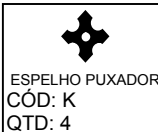

IMPORTANTE: PARA FACILITAR A MONTAGEM, FORRE O CHÃO COM O PAPELÃO DA EMBALAGEM, ASSIM PROTEGENDO AS PEÇAS PARA NÃO RISCAR