

ME-4146



Instruções de Montagem Assembly Instructions Instrucciones de Armado

Acesse Vídeos de Montagens
Access Mounting Videos
Acceder a los Vídeos de Montaje
www.tecnomobili.ind.br

tecnomobili

Estrada RSC 453, Km s/n° | Garibaldi | RS
CEP: 95720-000 | Fone / Fax: 54.3464.2050

sac@moveisvideira.com.br

Lista de Peças / List of pieces / Lista de piezas

Cód	DESCRIÇÃO	DESCRIPTION	DESCRIPCIÓN	QTD	RAW MATERIAL	DIMENSION
01	Tampo	Top	Tapa	1	MDP 15mm	1270x600x15
02	Travessa Frontal Tampo	Frontal Top Traverse	Traviesa Tapa Delante	1	MDP 15mm	1084x75x15
03	Costa	Back	Costa	1	MDP 15mm	1084x300x15
04	Lateral Direita	Right Side	Lateral Derecha	1	MDP 15mm	546x450x15
05	Lateral Esquerda	Left Side	Lateral Izquierda	1	MDP 15mm	546x450x15
06	Aplik	Aplik	Aplik	3	MDP 15mm	1082x30x15
07	Pé Dianteiro e Traseiro Esquerdo	Frontal Foot end Left Back	Pie Delante e Trasero Izquierdo	2	MDP 25mm	725x92x25
08	Pé Dianteiro e Traseiro Direito	Frontal Foot end Right Back	Pie Delante e Trasero Derecho	2	MDP 25mm	725x92x25
09	Apoio Lateral	Side Drawer	Apoyo Lateral	4	MDP 15mm	546x75x15
10	Base do Pé	Foot Base	Base de Pie	2	MDP 25mm	547x92x25

Notas Especiais:

01 -Examine completamente todas as peças do móvel antes de começar o trabalho.

02 -Recomenda-se montar o móvel conforme este Manual de Montagem.

03 -É de responsabilidade do montador seguir as instruções do Manual de Montagem, que são fundamentais para garantir a estrutura do móvel.

04 -Para limpeza, utilizar somente pano úmido e sabão neutro.

Special notes:

01 -Check all parts of the unit thoroughly before starting work.

02 -It is recommended to assemble the furniture according to this Installation Manual.

03 -It is the responsibility of the assembler to follow the instructions in the Assembly Manual, which are essential to ensure the structure of the furniture.

04 -For cleaning use only damp cloth and neutral soap.

Notas especiales:

01 -Examine completamente todas las piezas del mueble antes de iniciar el trabajo.

02 -Se recomienda montar el mueble conforme el Manual de Ensamblaje.





03 -Es de responsabilidad del montador seguir las instrucciones del Manual de Ensamblaje, que son fundamentales para garantizar la estructura del mueble.

04 -Para limpieza solamente usar trapo húmedo y jabón neutro.

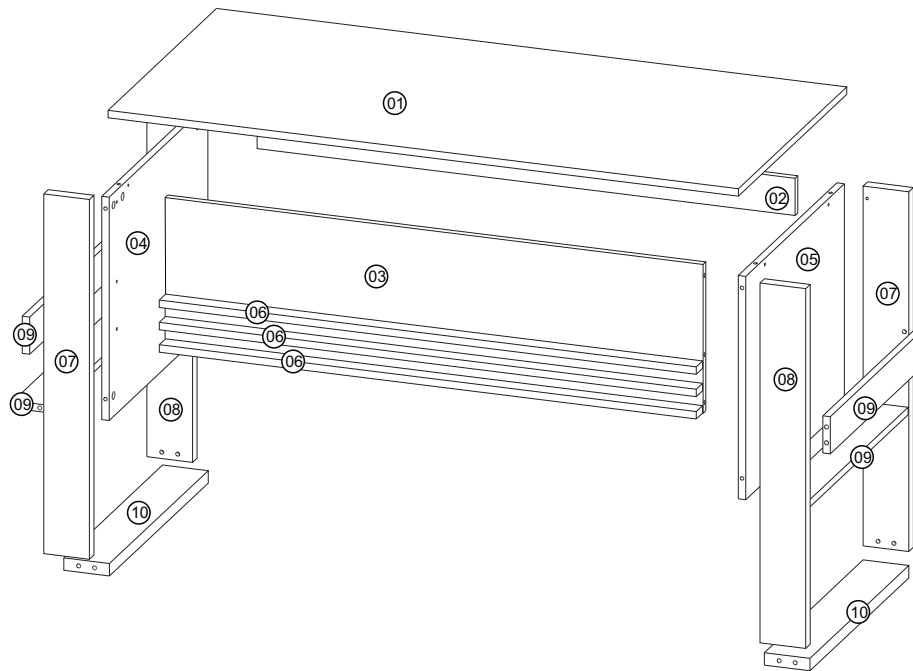
Guarante certificate:

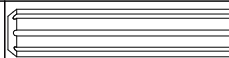
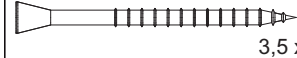
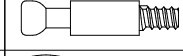
The guarantee of products manufactured by Móveis Videira LTDA covers any defects / manufacturing defects, within the period established by the Consumer Protection Code, in its Article 26, II, which provides for a legal guarantee of ninety (90) days.



REF	DESCRIÇÃO	QTD
A	 Cavilha 8 x 30mm	30
B	 3,5 x 35mm CC	09
C	 34 x 7mm	21
D	 15 x 12mm	21
E	 22 x 3mm	04
F	 14 x 4mm	04
G	 Adesivo Tapa Furo	23

Ferramentas | Tools | Herramientas

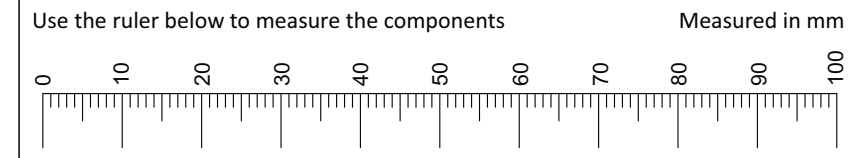
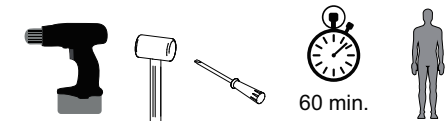

Revisão: 00
Data: 01/06/2019

01

