

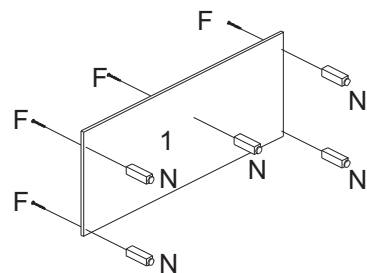











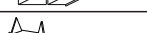

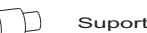

1° Passo



FERRAGENS

A		Parafuso 4 x 50
B		Prego 10 x 10
C		Puxador
D		Fixador de Fundo
E		Parafuso 3,5 x 25
F		Parafuso 4 x 40
G		Suporte Prateleira Movel
H		Parafuso 4,5 x 25
I		Dobradiça
J		Parafuso 3,5 x 14
K		Cantoneira
L		Cavilha
M		Corrediça telescópicas
N		Pés
O		Perfil h

2° Passo

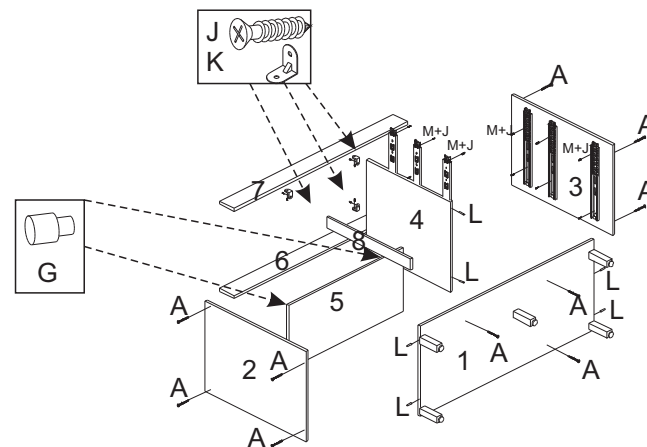

3° Passo

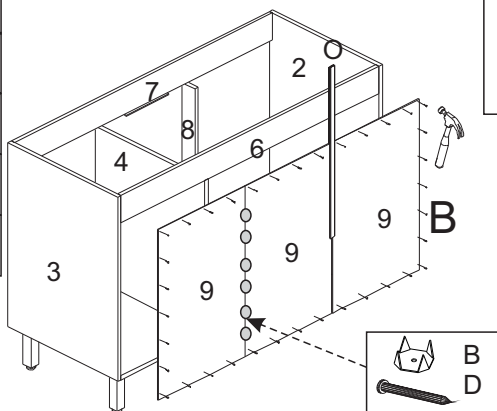

4° Passo

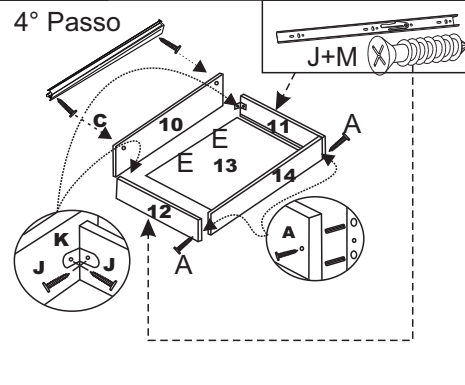



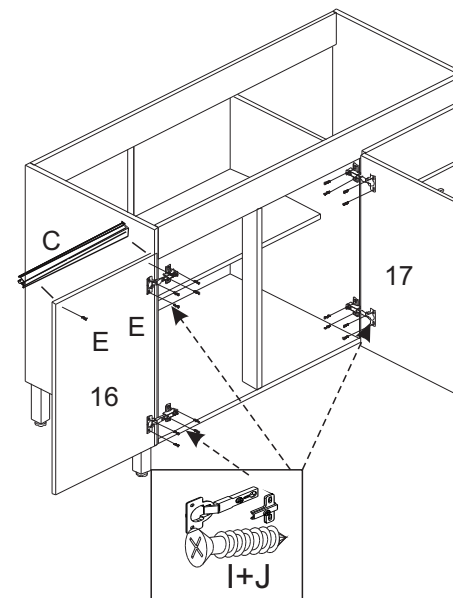

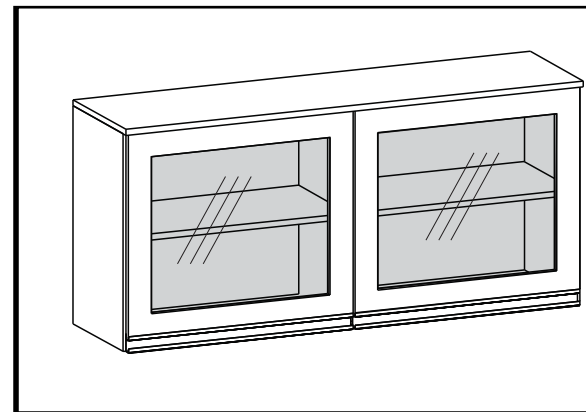



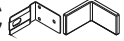

5° Passo



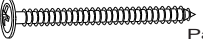

FERRAGENS

08	A		Suporte Pino
12	B		Parafuso 4 x 40
03	C		Suporte aéreo + capa
33	D		Parafuso 3,5 x 14
04	E		Dobradiça 35mm
40	F		Prego 10 x 10
10	G		Fixador de fundo
06	H		Tapa Furo
03	I		Parafuso 5 x 40mm
00	J		Puxador Perfil
08	K		Bucha

1º passo

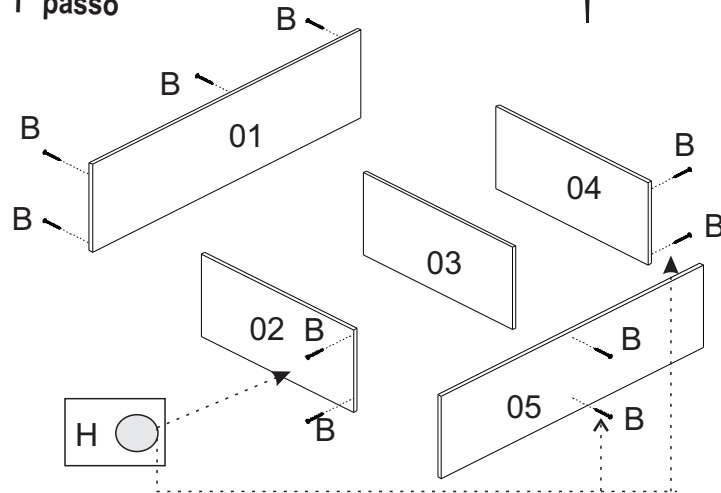

2º passo

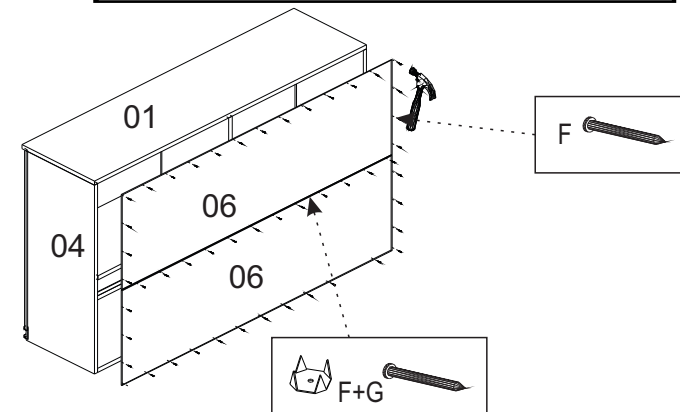

3º passo

