

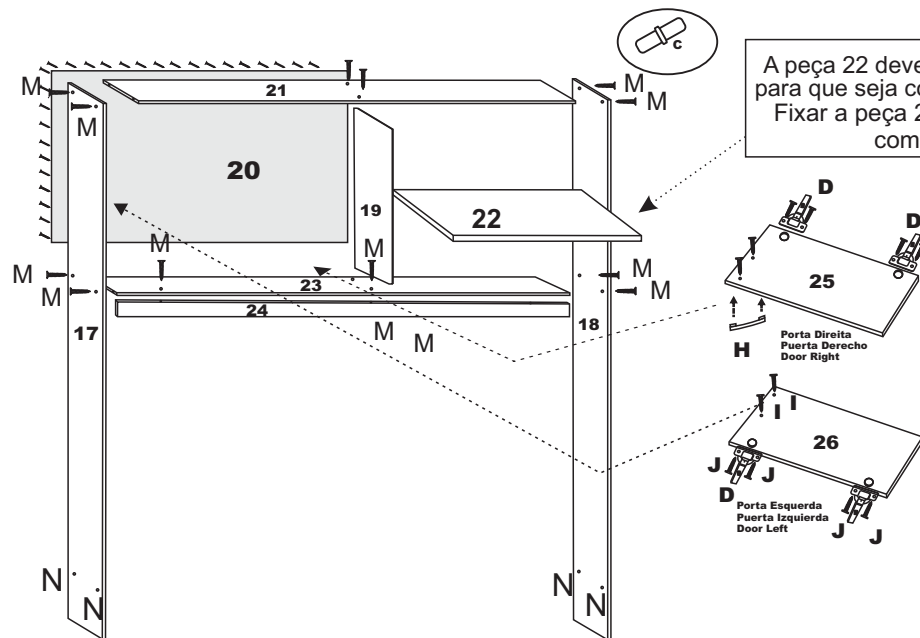







1º Passo / 1 Paso / 1 Step



A peça 22 deve ser sobreposta a peça 23 para que seja colocado o forno/microondas.
 Fixar a peça 22, por baixo da peça 23 com 4 parafusos M

FERRAGENS / HERRAJES / HARDWARE

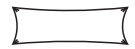
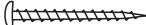
B	Prego 10x10 Clavo 10x10 Nail 10x10	
C	Soporte estanteria	
D	Dobradiça Bisagra Hinge	
F	Cantoneira 18x18 Esquieira 18x18	
H	Puxador Tirador Handle	
I	Parafuso 3,5 x 25 c/c Tornillo 3,5 x 25 c/c Screw 3,5 x 25 c/c	
J	Parafuso 3,5 x 14 C/C Tornilho 3,5 x 14 Screw 3,5 x 14	
L	Cola Pegamento Glues	
M	Parafuso 4 x 40 Tornilho 4 x 40 Screw 4 x 40	
N	Parafuso União Tornilho Screw	