

# Cozinha 7 portas 2 gavetas

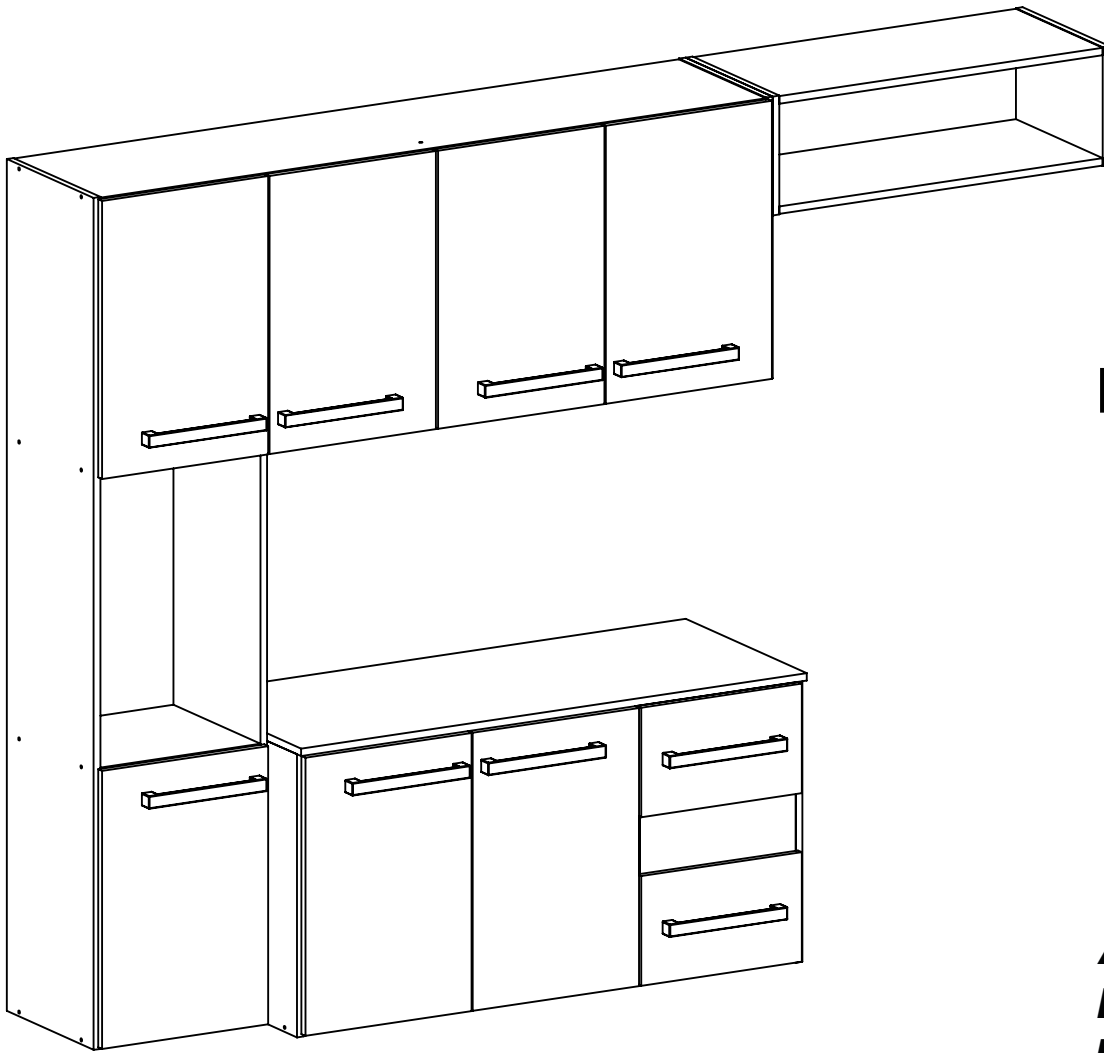

**REF.CZ7200**

COD. FERRAGEM:26362/26429

**Altura: 1360**  
**Largura: 1810**  
**Profundidade: 380**

## ATENÇÃO

- ➔ Ler atentamente toda a instrução antes de iniciar a montagem;
- ➔ A montagem do produto deverá ser feita em superfície limpa e plana;
- ➔ Aconselhamos utilizar a embalagem do produto para forrar o chão a fim de não danificar o produto;
- ➔ Evitar batidas e o contato com objetos cortantes;
- ➔ Observar carga máxima suportado pelo produto;

## LIMPEZA

- ➔ Pano levemente umedecido com água seguido de pano seco;
- ➔ Não utilizar produtos químicos e abrasivos;

## ATENCIÓN

- ➔ Lea y siga todas las instrucciones cuidadosamente antes de iniciar el montaje;
- ➔ El montaje del producto debe estar en una superficie limpia y plana;
- ➔ Recomienda utilizar el embalaje para cubrir el suelo con el fin de no dañar producto;
- ➔ Eviten los golpes y el contacto con objetos punzantes;

## LIMPIEZA

- ➔ Paño ligeramente humedecido con agua, seguido por un paño seco;
- ➔ No utilice productos químicos y abrasivos;

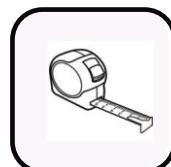
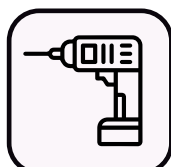

**IMPORTANTE:** Antes de iniciar a montagem identifique todas as peças e acessórios e siga todos os passos deste manual. Em caso de falta de peças ou peças danificadas solicite assistência técnica informando o numero da peça ou letra do acessório.

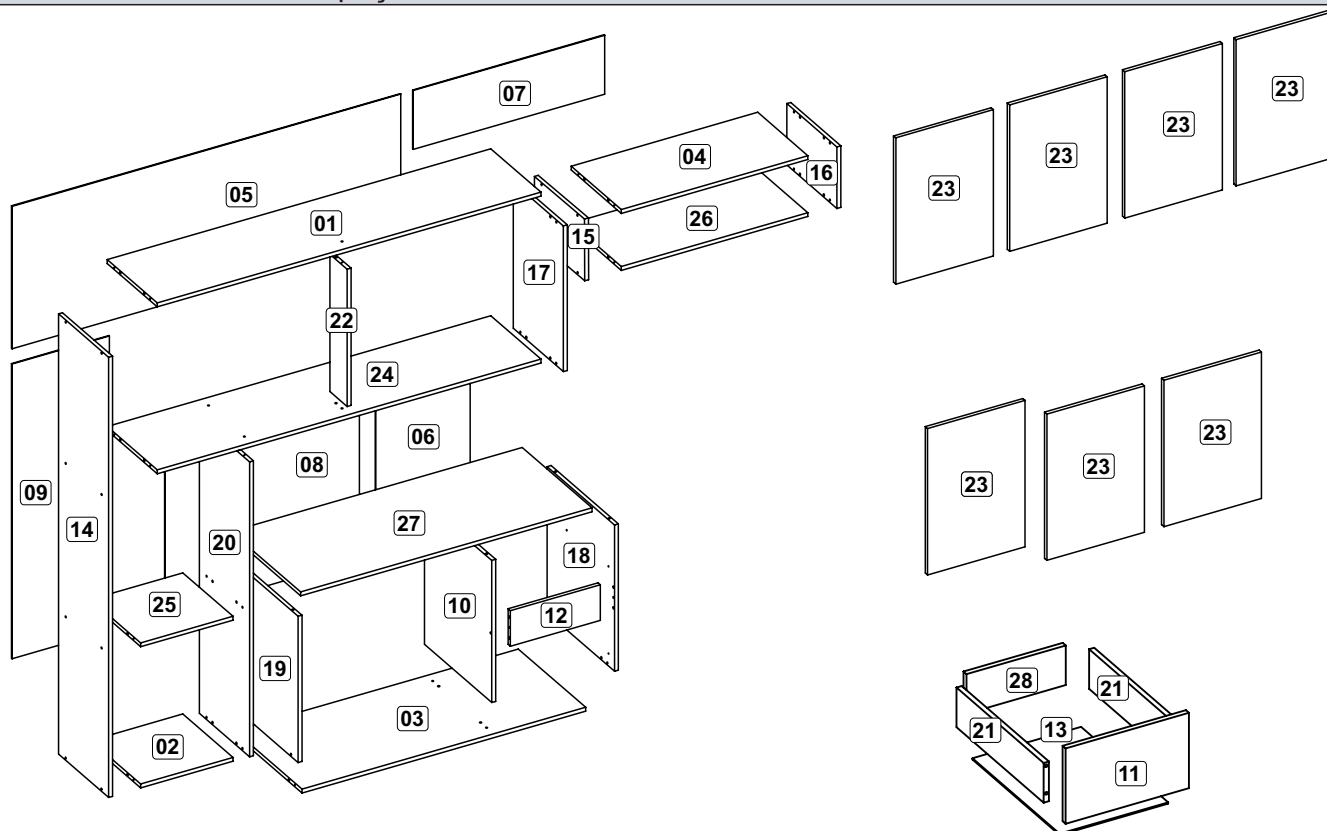

Nº DA PEÇA	DESCRIÇÃO	QTD	COD. BRANCO	COD. CASTANHO
1	CHAPÉU 1185X268X12	1	11111	11111
2	CHAPÉU 285X268X12	1	11111	11111
3	CHAPÉU 876X360X12	1	11111	11111
4	CHAPÉU 576X268X12	1	11111	11111
5	COSTA 1201X440X3	1	11111	11111
6	COSTA 292X456X3	1	11111	11111
7	COSTA 592X182X3	1	11111	11111
8	COSTA 600X456X3	1	11111	11111
9	COSTA 910X301X3	1	11111	11111
10	DIVISÃO 439X360X12 ESQ	1	11111	11111
11	FRENTE GAVETA 286X175X12	2	11111	11111
12	FRONTAL 278X110X12	1	11111	11111
13	FUNDO GAVETA 252X350X3	2	11111	11111
14	LATERAL 1360X268X12	1	11111	11111
15	LATERAL 190X268X12 ESQ	1	11111	11111
16	LATERAL 190X268X12 DIR	1	11111	11111
17	LATERAL 450X268X12 DIR	1	11111	11111
18	LATERAL 452X360X12 DIR	1	11111	11111
19	LATERAL 452X360X12 ESQ	1	11111	11111
20	LATERAL 911X268X12 DIR	1	11111	11111
21	LATERAL DE GAVETA 350X92X12	4	11111	11111
22	PILASTRA 424X92X12	1	11111	11111
23	PORTA 444X296X12	7	11111	11111
24	TAMPO 1185X268X12	1	11111	11111
25	TAMPO 285X268X12	1	11111	11111
26	TAMPO 576X268X12	1	11111	11111
27	TAMPO 900X373X12	1	11111	11111
28	TRASEIRO DE GAVETA 230X92X12	2	11111	11111

# Lista das Ferragens

4,0X40-Cod 3983

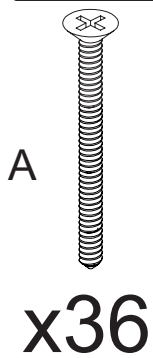

4,5X50-Cod 23927

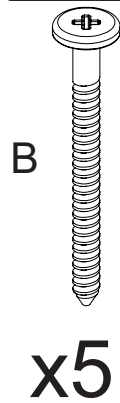

3,5x25-Cod 3870

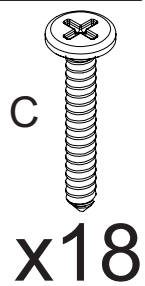

3,5x12-Cod 3385



3,5x12 Corrediça-Cod 5738



6x30-Cod 3881

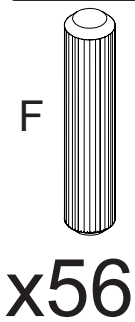

10x10-Cod 3875

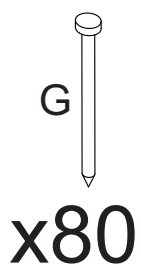

12x12-Cod 3876

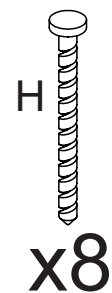

Cod 3877

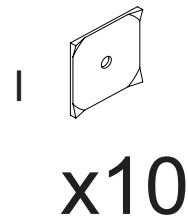

192MM-Cod 15285

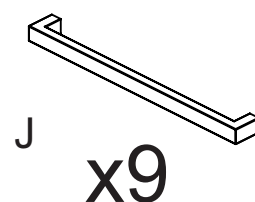

350MM-Cod 16453

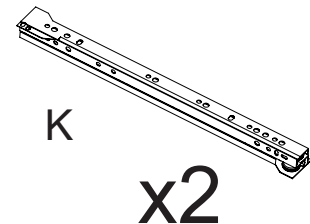

Cod 3882

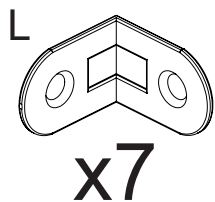

Cod 3872

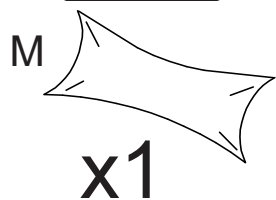

Cod 3384

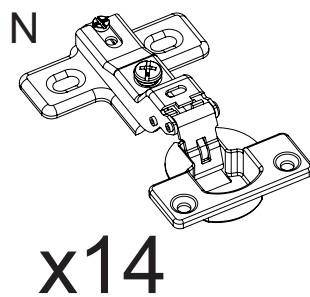

Cod 15356

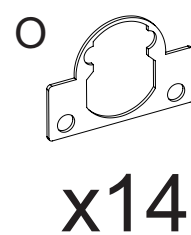

Cod 23804

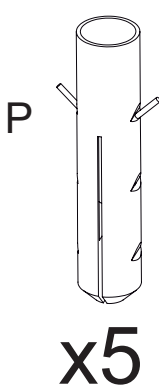

Cod 26426

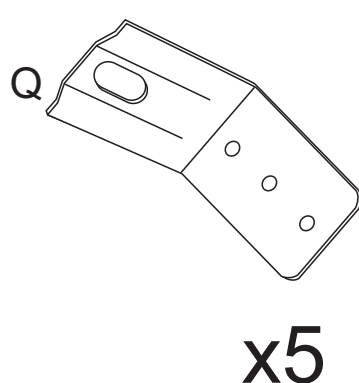

Cod 26427

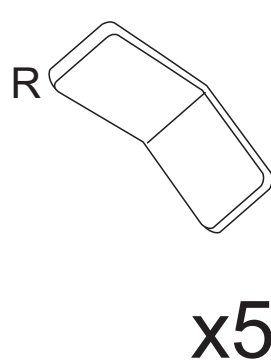

3,5x20-Cod 7035

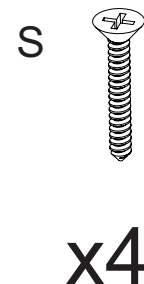

1:1

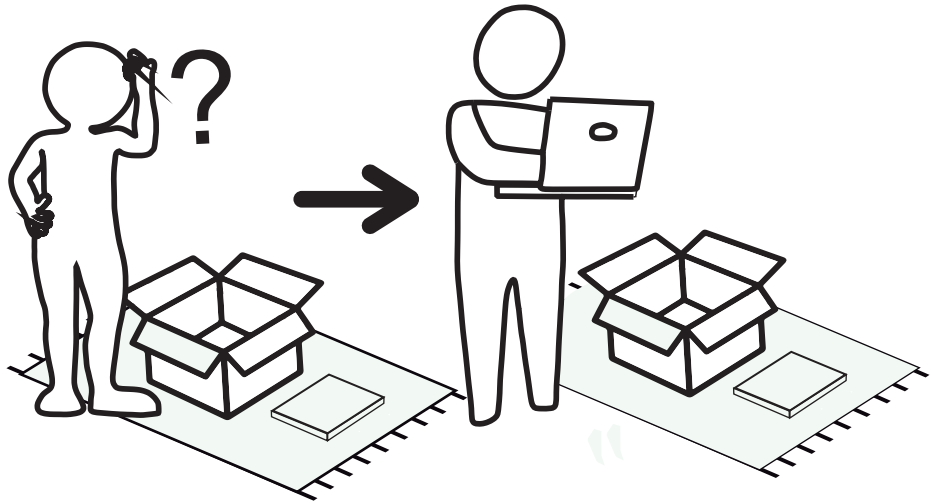
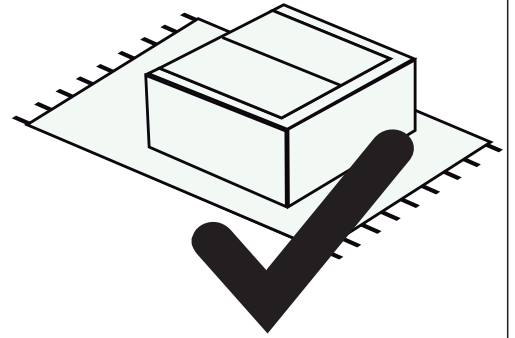
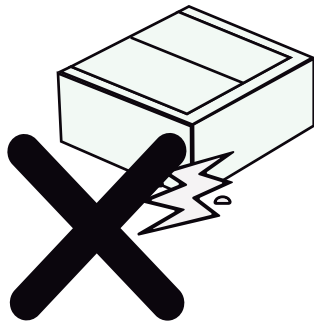
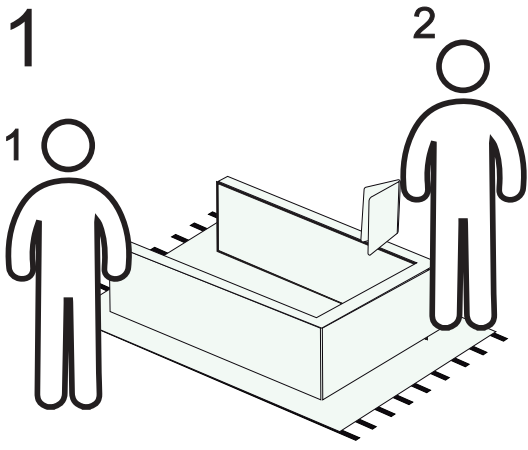

2

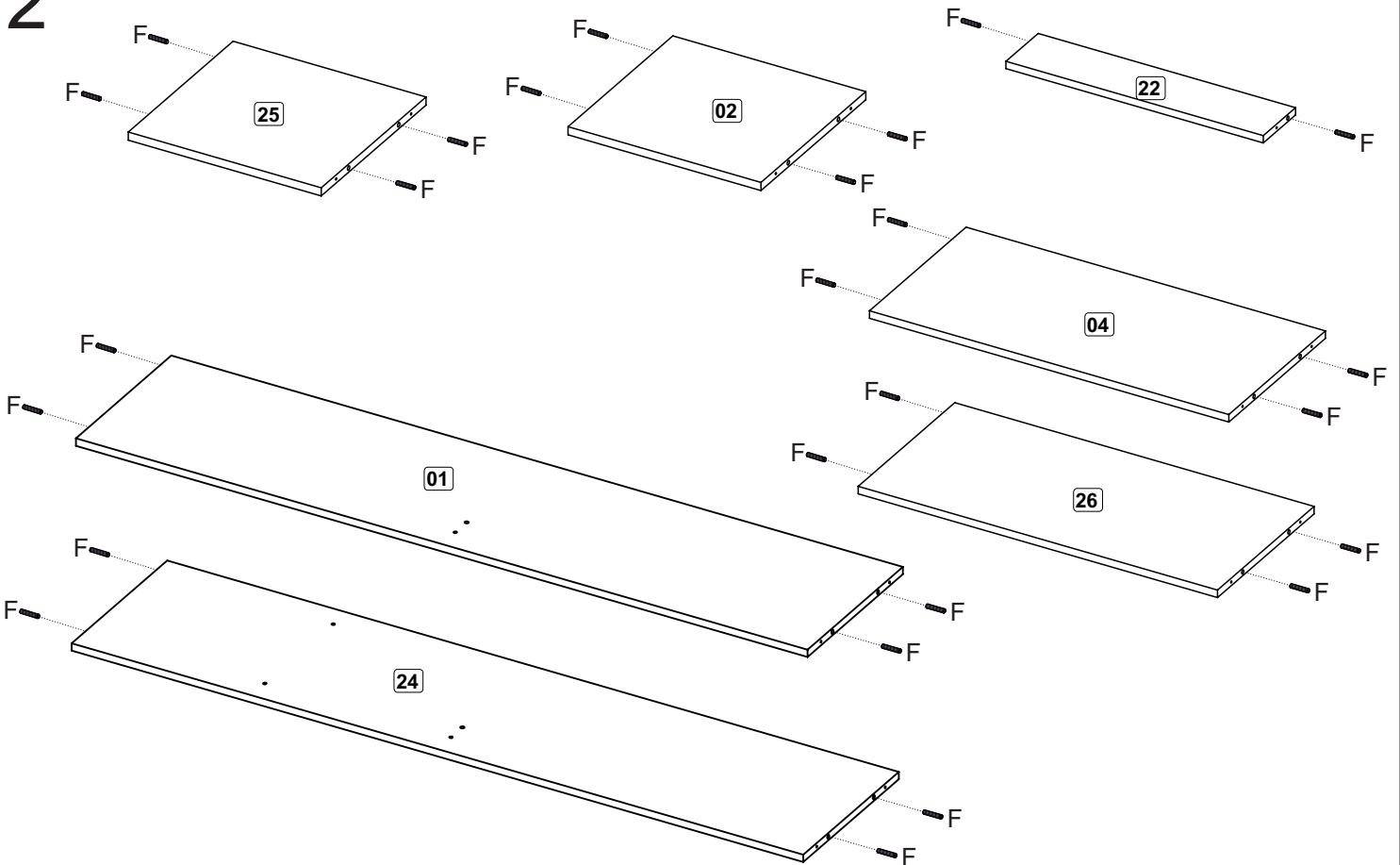

3

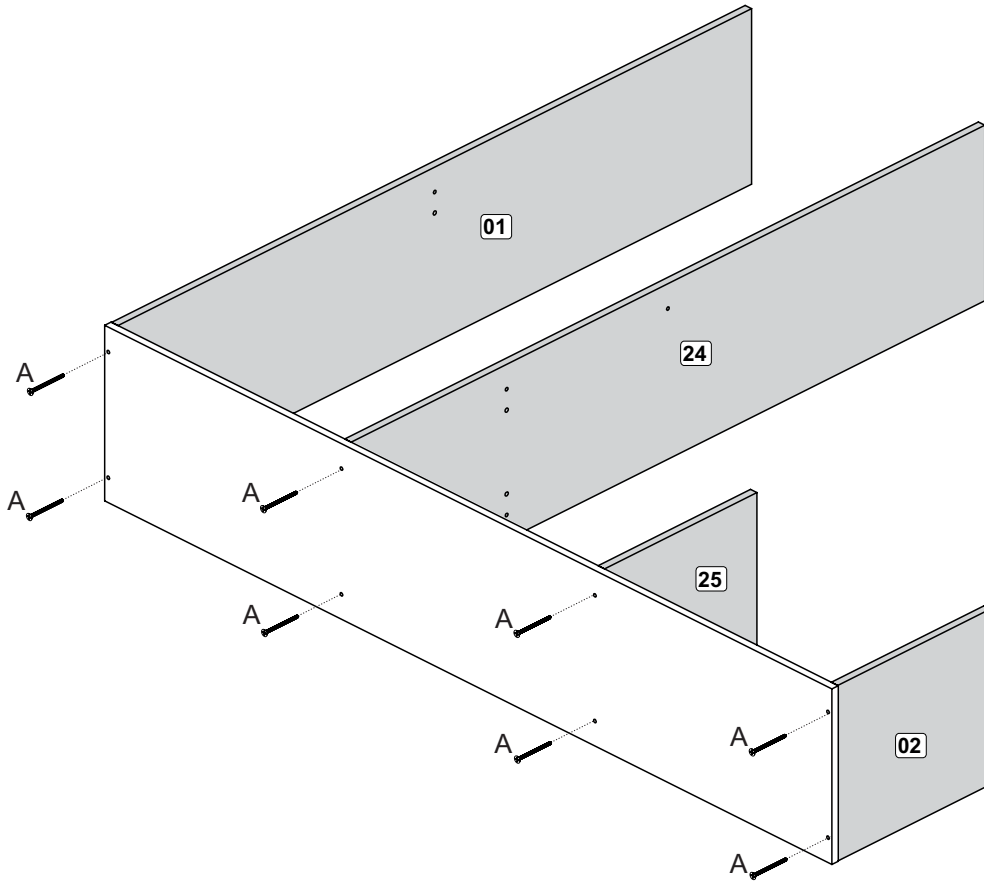

4

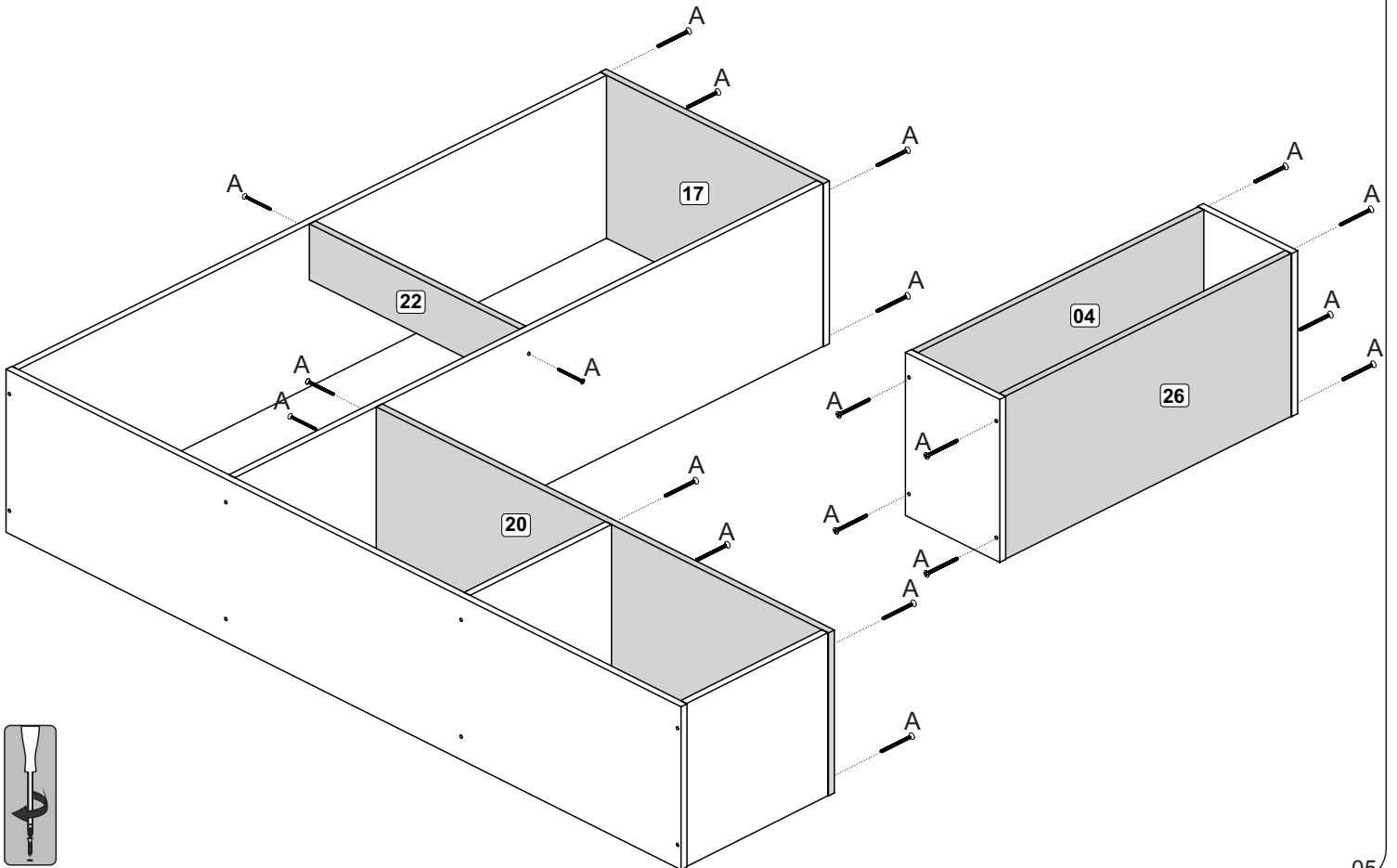

5

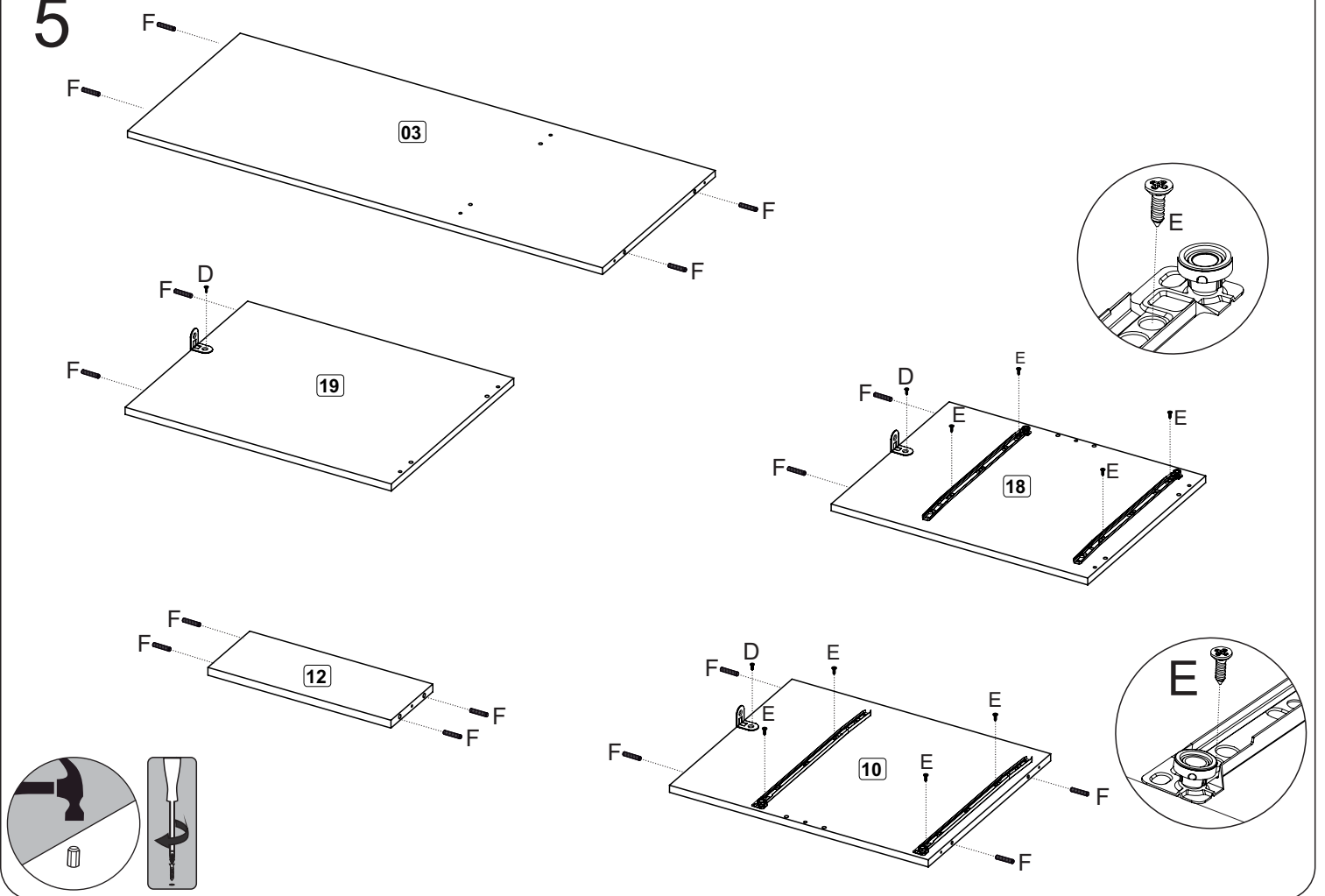

6

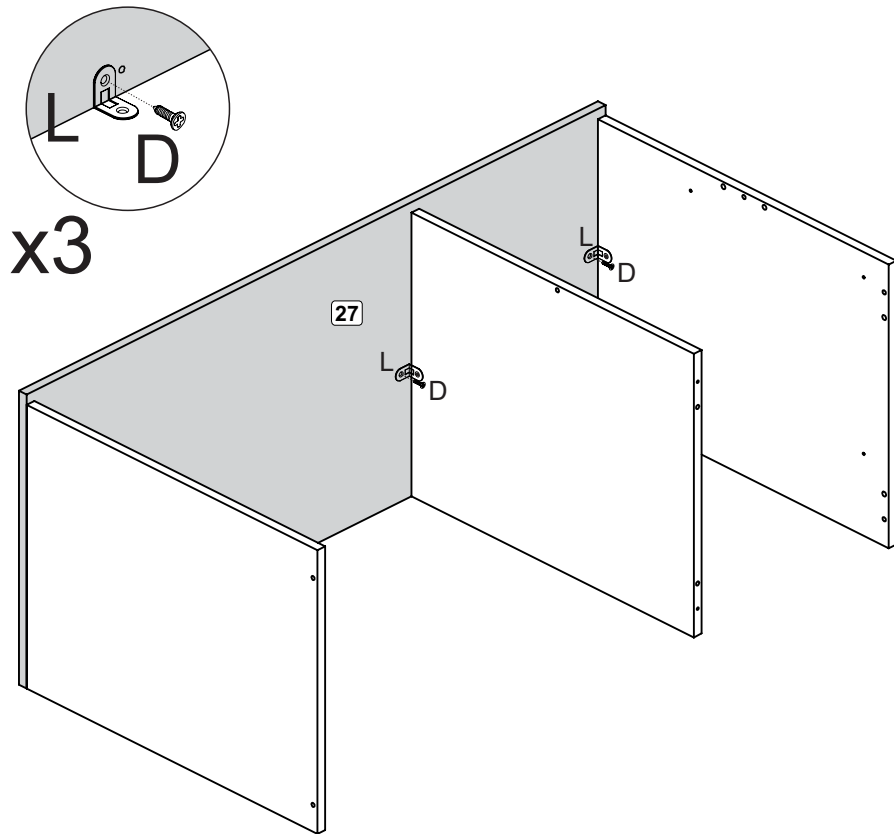

7

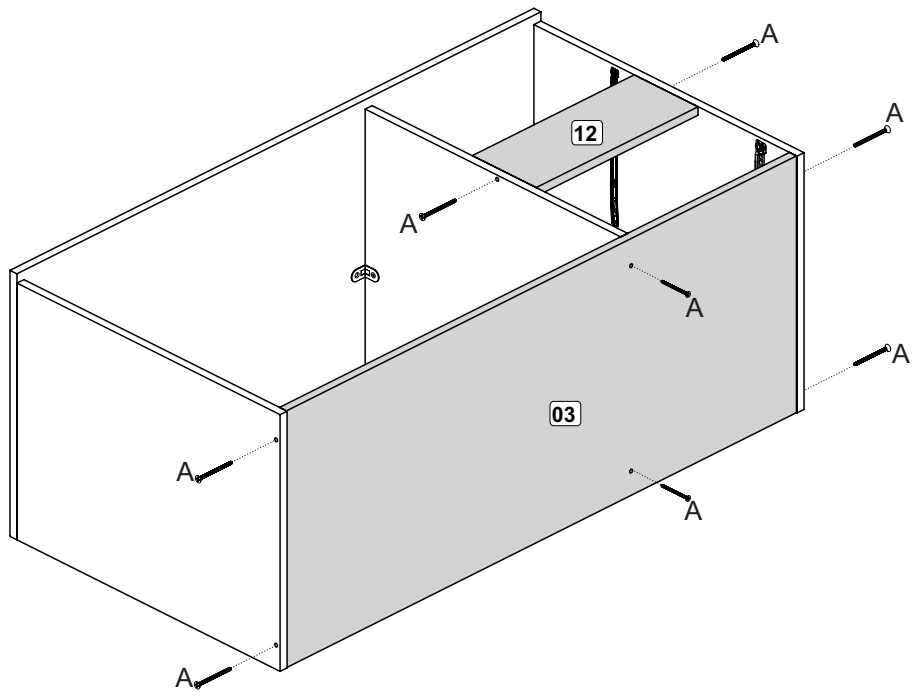

8

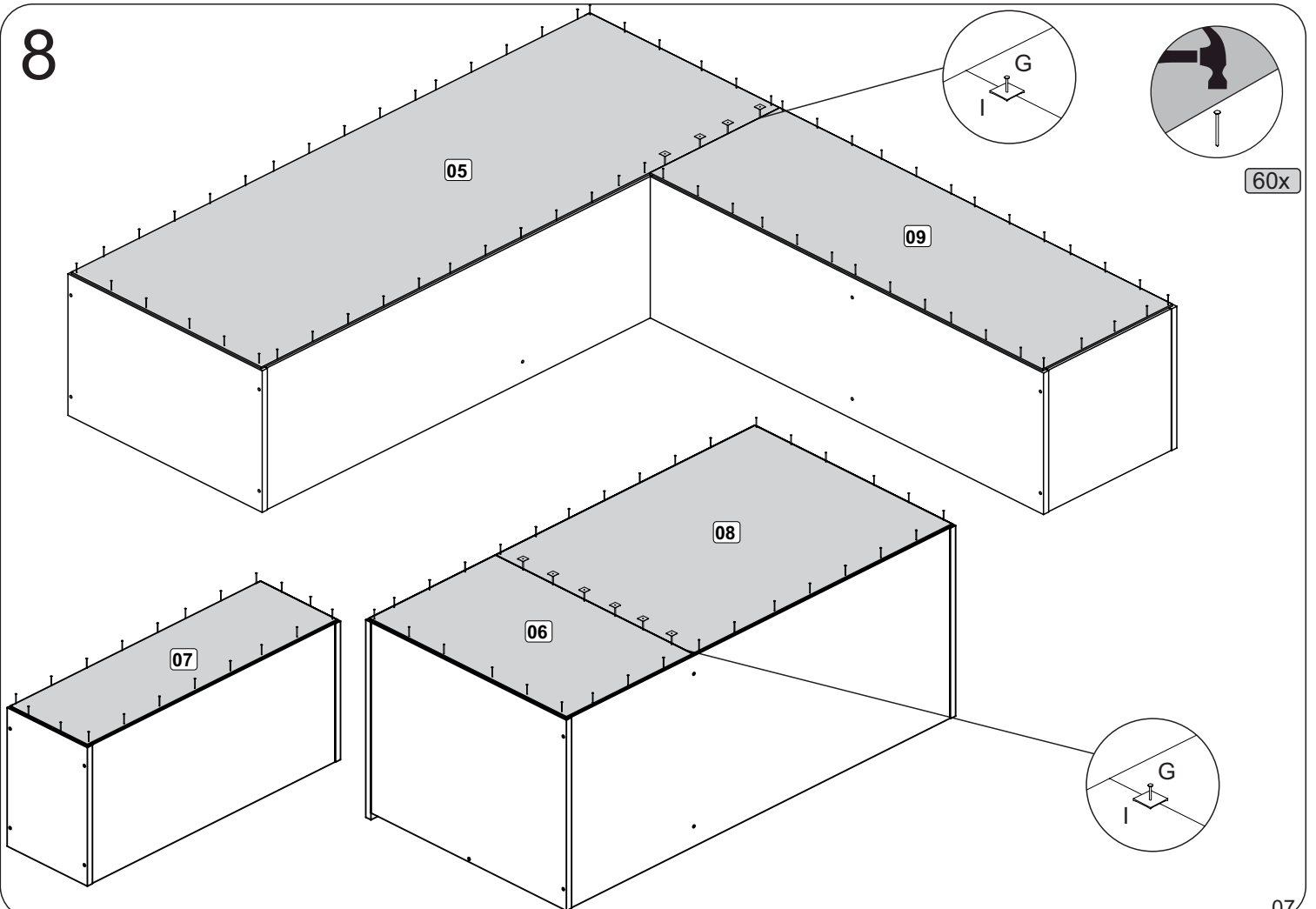

9

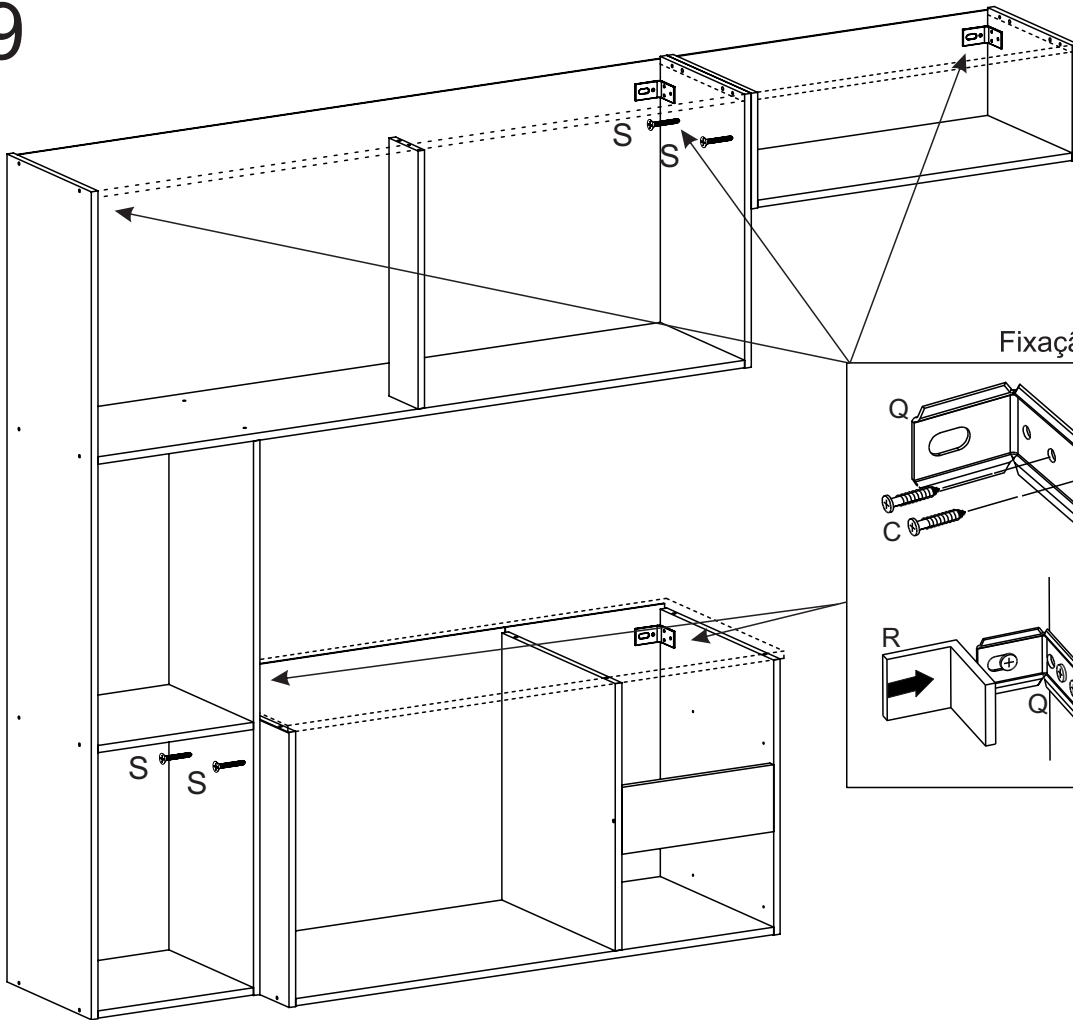

Fixação na parede

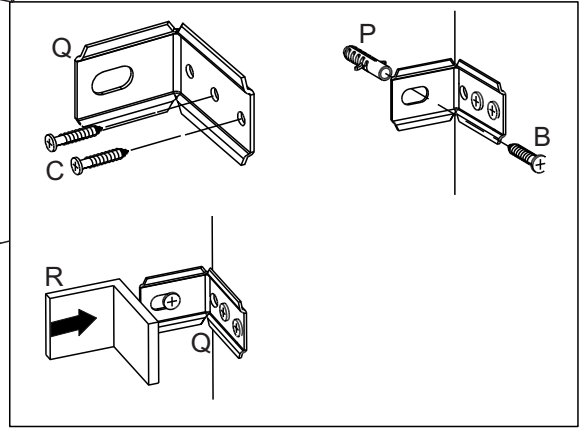

10

Nota: Utilizar o calço (O) na dobradiça (N)

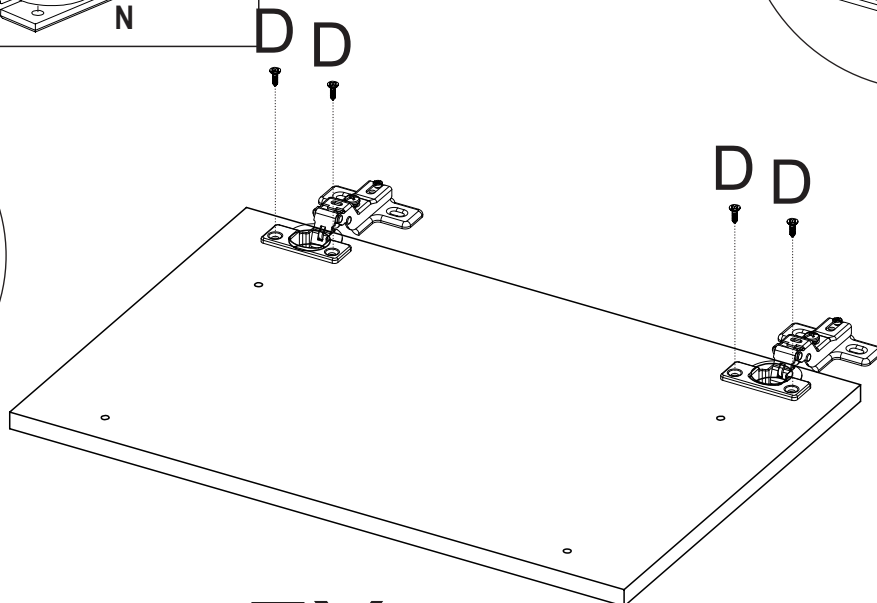
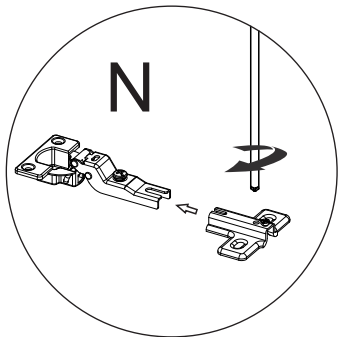
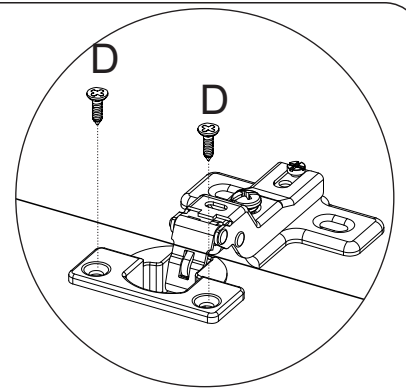
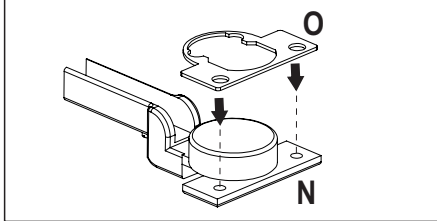

7X





# 11

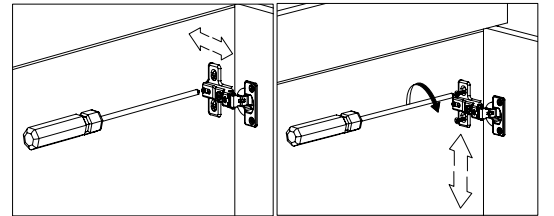
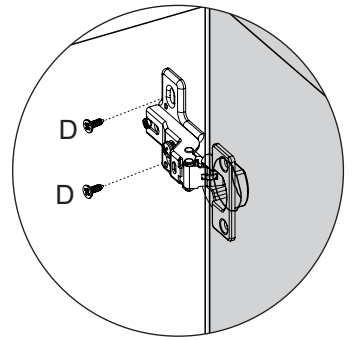
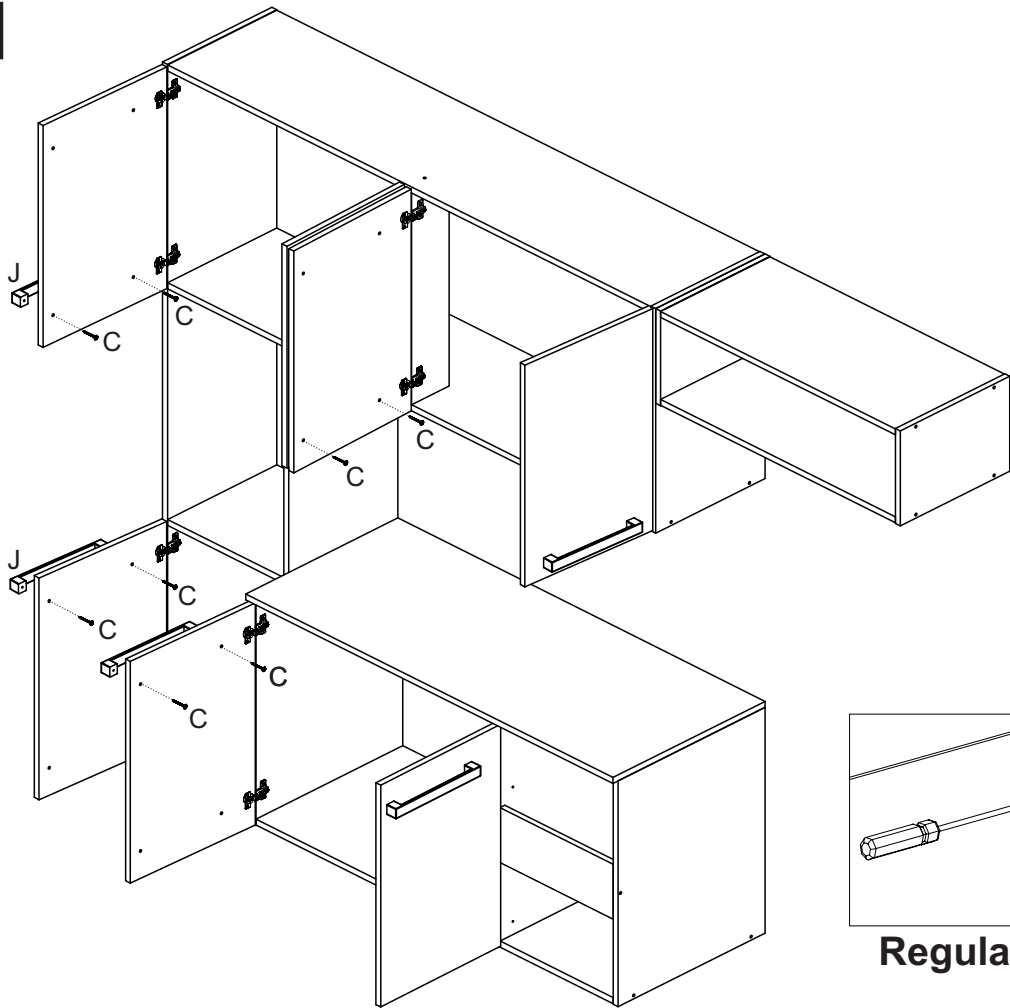

**Regulagem da Dobradiça**

# 12

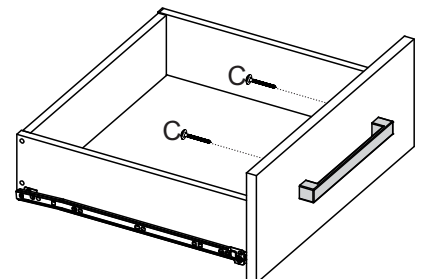
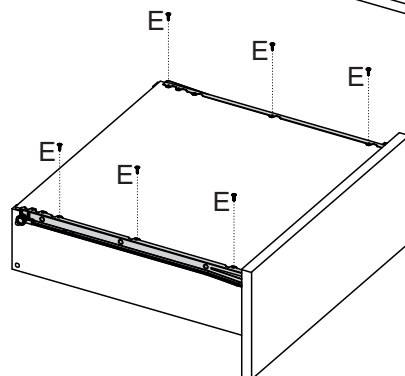
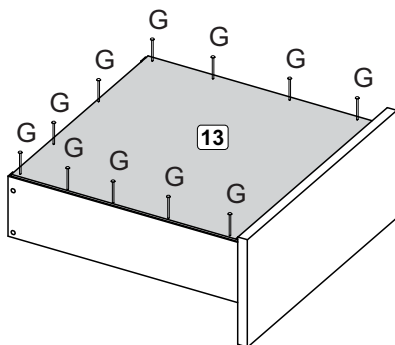
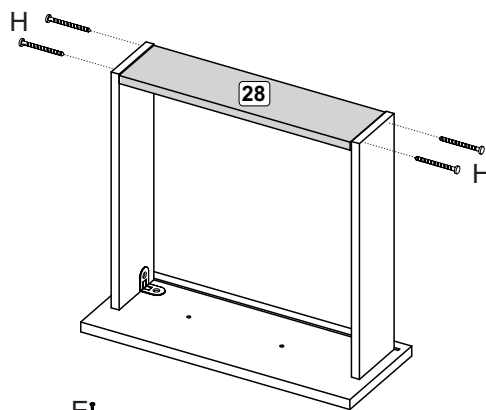
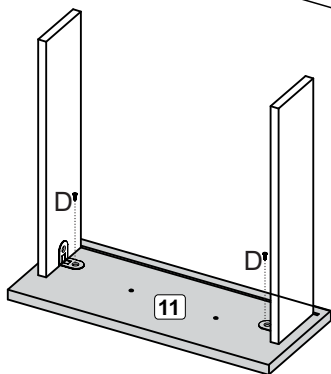
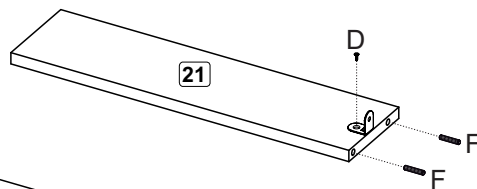
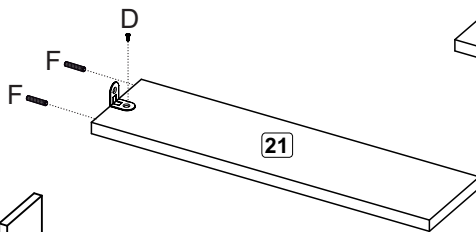
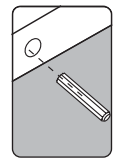

13

