

**HENN**Ind. e Com. de Móveis Henn  
Mondai - SC - Brasil

☎ +55 49 3674.3500

📷 📱 @moveishenn  
www.henn.com.br**INSTRUÇÕES DE  
MONTAGEM**INSTRUCCIONES DE MONTAJE  
ASSEMBLY INSTRUCTIONS**Torre Quente 02 Fornos 715mm Requite |**

Torre Caliente 02 Hornos 715mm Requite | Hot Tower 02 Ovens 715mm Requite

C643-217 Nature/Areia HP

C643-218 Nature/Nature/Areia HP

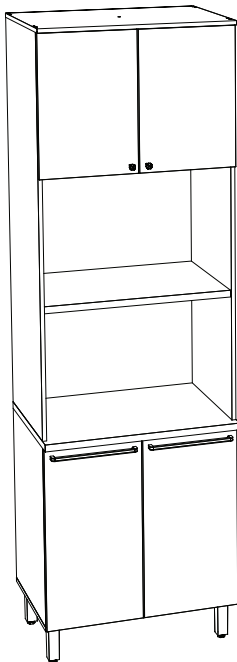
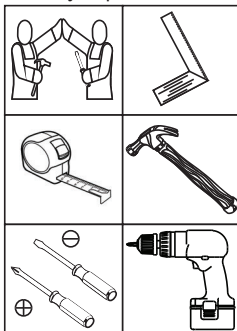
Requisitos para montagem  
Requisitos para la montaje  
Assembly Requirements

Imagens meramente ilustrativas,  
não acompanha o produto.  
Imágenes ilustrativas, no incluidas  
con el producto.  
Illustrative images, not included  
with the product.

**AVISO**

Para limpeza de seu móvel, use uma franela seca ou umedecida, e não utilize produtos químicos que possam danificar seu produto.

**SISTEMA DE MONTAGEM**

O sistema de montagem dos produtos, funciona de acordo com a ordem crescente dos números indicados no desenho. Ex: 01, 02, 03, 04... até a conclusão da montagem.

**ASSISTÊNCIA TÉCNICA**

Para solicitação de Assistência Técnica você consumidor deverá entrar em contato com o Lojista a qual você realizou a compra deste produto e solicitar a assistência técnica das peças avariadas. A garantia abrange todas as peças, partes e componentes que eventualmente venham apresentar defeito de fabricação no prazo de 03 (três) meses, contando a partir da entrega do produto ao consumidor, mediante nota fiscal de compra. Se houver qualquer alteração na estrutura do produto ou ocorrer defeito por negligência do montador/consumidor em relação a instrução de montagem e manuseio, não será fornecido assistência técnica gratuita.

**ADVERTENCIA**

Para limpieza de su móvil, use una franela seca o húmeda, y no utilice productos químicos que puedan dañar su producto.

**SISTEMA DE MONTAJE**

El sistema de montaje de los productos funciona de acuerdo con el orden creciente de los números indicados en el dibujo. Ej.: 01, 02, 03, 04... hasta la conclusión del montaje.

**ASISTENCIA TÉCNICA**

Para solicitar Asistencia Técnica, el consumidor debe comunicarse con el Comercio que usted realizó la compra de este producto y solicita asistencia técnica para las partes dañadas. La garantía cubre todas las partes, piezas y componentes que eventualmente puedan presentar defecto de fabricación en el plazo de 03 (tres) meses, contados a partir de la entrega del producto al consumidor, mediante factura de compra. Si se produce algún cambio en la estructura del producto o se produce un defecto por negligencia del montador/consumidor en relación con las instrucciones de montaje y manipulación, no se prestará asistencia técnica gratuita.

**NOTICE**

To clean your furniture, use a dry or wet cloth, and do not use chemicals that may damage your product.

**ASSEMBLY SYSTEM**

The products' assembly system works according to the increasing order of the indicated numbers. For example: 01, 02, 03, 04 ... to the end of the assembly.

**TECHNICAL ASSISTANCE**

To request Technical Assistance, the consumer must contact the retailer from whom you purchased this product and request technical assistance for the damaged parts. The warranty covers all parts, parts and components that may eventually present a manufacturing defect within a period of 03 (three) months, counting from the delivery of the product to the consumer, by means of a purchase invoice. If there is any change in the structure of the product or defect occurs due to negligence of the assembler/consumer in relation to the assembly and handling instruction, free technical assistance will not be provided.

# ACESSÓRIOS | ACCESORIOS | ACCESSORIES

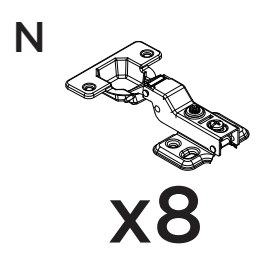
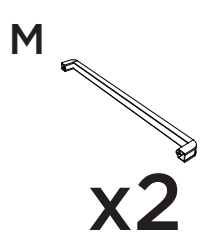
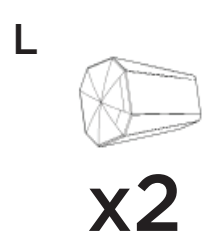
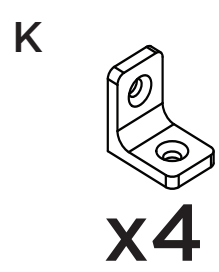
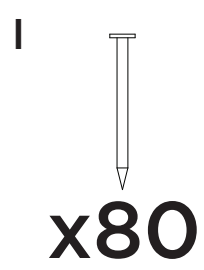
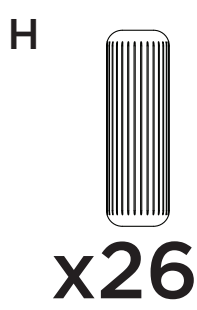
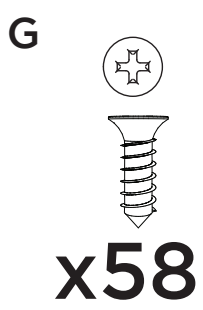
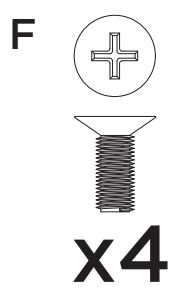
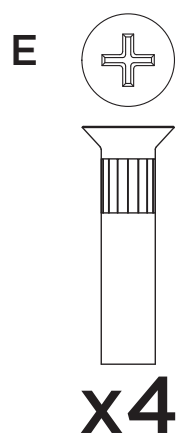
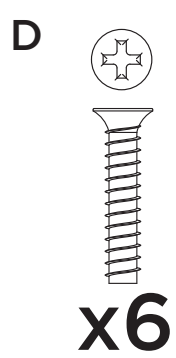
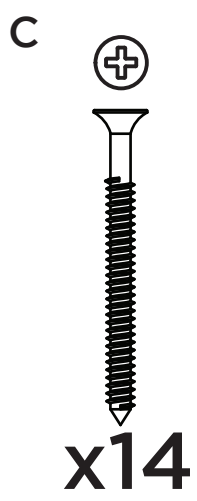
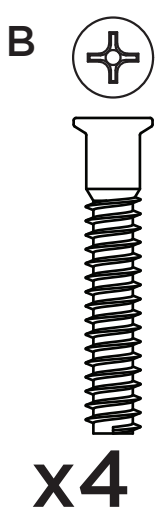
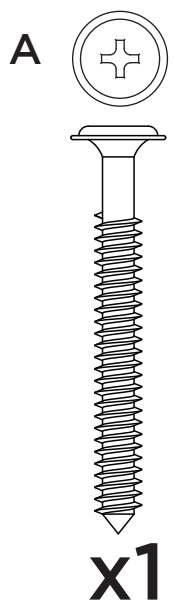

Parafusos em escala  
Tornillos escalados  
Scaled screws **1:1**

## ACESSÓRIOS | ACCESORIOS | ACCESSORIES

O

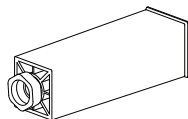

x4

P

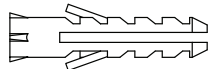

x1

Q

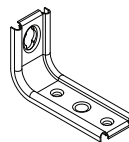

x1

R

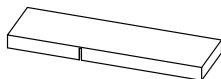

x1

S

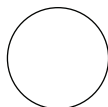

x16

T

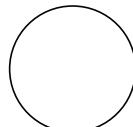

x12

U

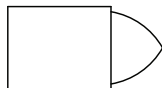

x3

V

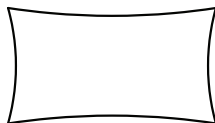

x1

W



x1

X



x4

Y

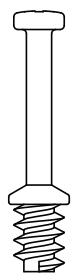

x8

Z



x8

Parafusos em escala  
Tornillos escalados  
Scaled screws 1:1



Os parafusos (E/F) devem ser usados somente quando este módulo for acoplado a outro módulo componível Henn.



Los tornillos (E/F) se debe utilizar sólo cuando el módulo está conectado a otro módulo componible Henn.



Screws (E/F) are to be used only when this module is mated to another Henn buildable module.

# LISTA DE PEÇAS | LISTA DE PIEZAS | LIST OF PIECES

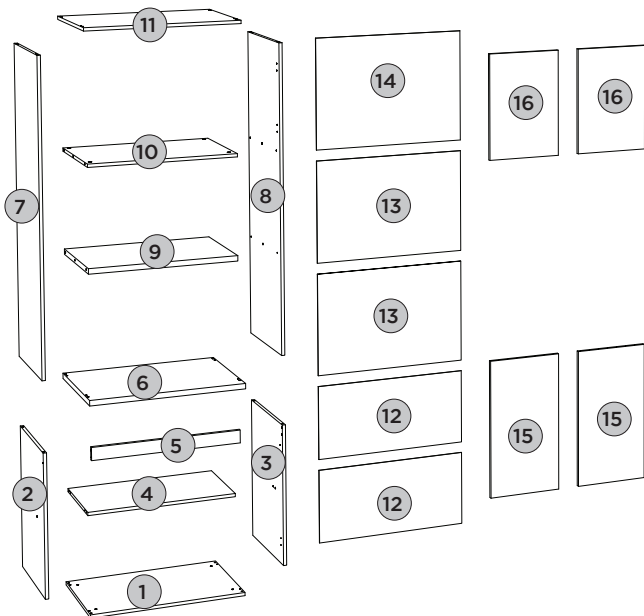

Item	Caixa Caja Box	Qty Ctd Qty	Descrição Descripción Description	Dimensões (mm)   Dimensiones (mm)   Dimensions (mm)		
				Comprimento Largo Length	Largura Ancho Width	Espessura Grosor Thickness
1	1/1	01	BASE   BASE   BASE	715	490	15
2	1/1	01	LATERAL ESQUERDA INFERIOR   LATERAL IZQUIERDA INFERIOR   LEFT SIDE LOWER	660	490	15
3	1/1	01	LATERAL DIREITA INFERIOR   LATERAL DERECHA INFERIOR   RIGHT SIDE LOWER	660	490	15
4	1/1	01	PRATELEIRA   ESTANTE   SHELF	684	400	15
5	1/1	01	TRAVESSA FRONTAL   TRAVESAÑO FRONTAL   FRONT CROSS- BAR	684	60	15
6	1/1	01	TAMPO 25MM   TAPA 25MM   TOP 25MM	715	533	25
7	1/1	01	LATERAL ESQUERDA SUPERIOR   LATERAL IZQUIERDA SUPE- RIOR   UPPER LEFT SIDE	1445	490	15
8	1/1	01	LATERAL DIREITA SUPERIOR   LATERAL DERECHA SUPERIOR   UPPER RIGHT SIDE	1445	490	15
9	1/1	01	PRATELEIRA CENTRAL   ESTANTE CENTRAL   CENTRAL SHELF	684	480	25
10	1/1	01	BASE AÉREO   BASE AEREO   AIR BASE	684	490	15
11	1/1	01	TAMPO   TAPA   TOP	715	517	15
12	1/1	02	FUNDO INFERIOR   FONDO INFERIOR   LOWER BACKGROUND	708	343	3
13	1/1	02	FUNDO CENTRAL   FONDO CENTRAL   CENTRAL FUND	708	475	3
14	1/1	01	FUNDO SUPERIOR   FONDO SUPERIOR   UPPER BACKGROUND	708	517	3
15	1/1	02	PORTA INFERIOR   PUERTA INFERIOR   LOWER DOOR	665	354	15
16	1/1	02	PORTA   PUERTA   DOOR	508	354	15





# PASSO 1

ITM/C643-

## PEÇAS REQUERIDAS

1	BASE	x1
2	LATERAL ESQUERDA INFERIOR	x1
3	LATERAL DIREITA INFERIOR	x1
4	PRATELEIRA	x1
5	TRAVESSA FRONTAL	x1

## ACESSÓRIOS REQUERIDOS

B		04
H		14
O		04
V		

## FERRAMENTAS NECESSÁRIAS

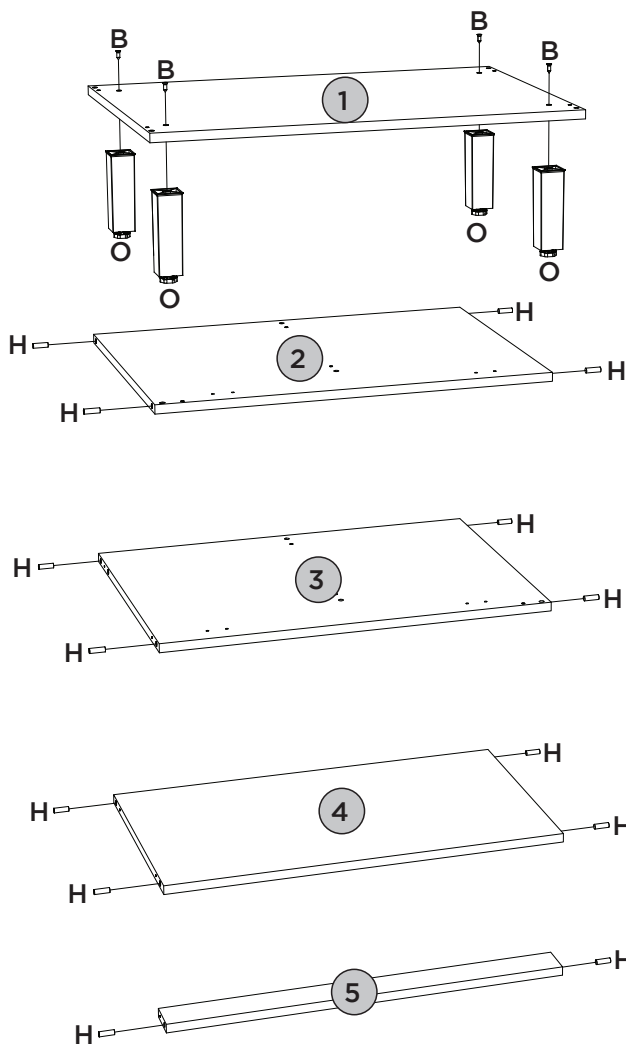
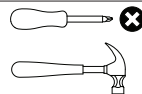

Utilizar o sachê de cola (V) em todas as cavilhas (H) do produto.

Con el pegamento sobre (V) en todos los pernos (H) producto.

Use the glue sachet (V) on all the pegs (H) of the product.



# PASSO 2

ITM/C643-

## PEÇAS REQUERIDAS

7	LATERAL ESQUERDA SUPERIOR	x1
8	LATERAL DIREITA SUPERIOR	x1
9	PRATELEIRA CENTRAL	x1
10	BASE AÉREO	x1

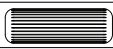
## ACESSÓRIOS REQUERIDOS

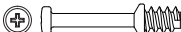
H		12
V		
Y		08

## FERRAMENTAS NECESSÁRIAS

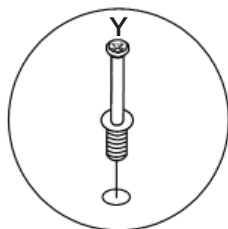
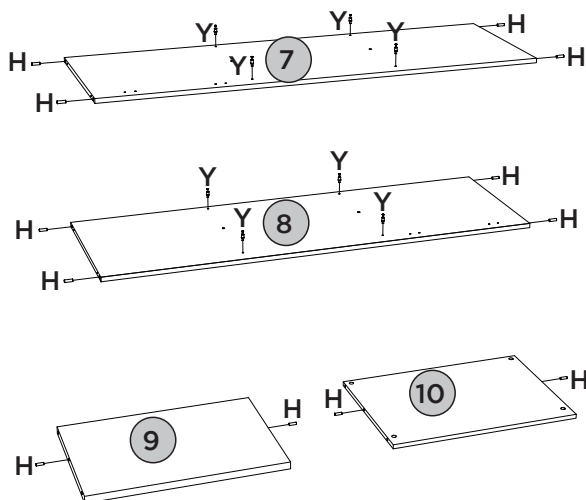
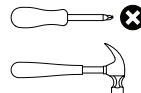



# PASSO 3

## PEÇAS REQUERIDAS

1	BASE	x1
2	LATERAL ESQUERDA INFERIOR	x1
3	LATERAL DIREITA INFERIOR	x1
4	PRATELEIRA	x1
5	TRAVESSA FRONTAL	x1

## ACESSÓRIOS REQUERIDOS

C		10
V		



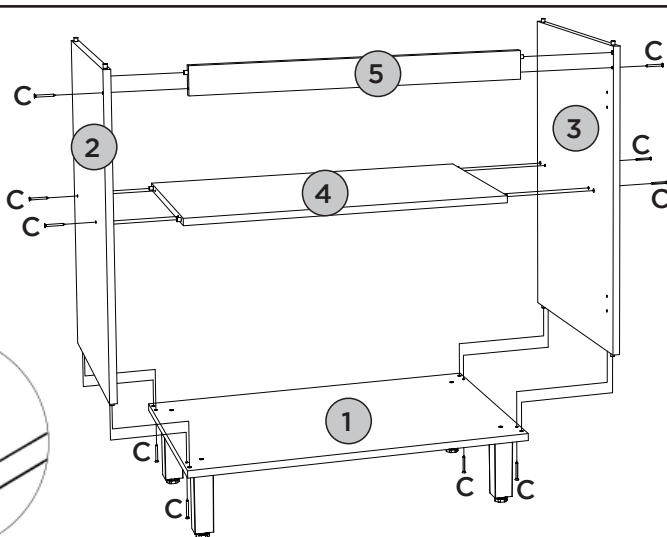
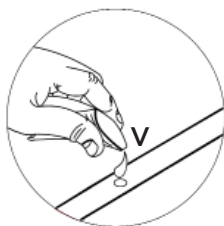
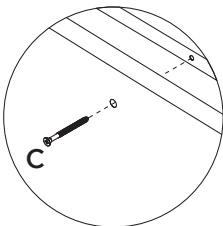
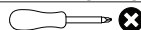

## FERRAMENTAS NECESSÁRIAS



**PEÇAS REQUERIDAS**

6	TAMPO 25MM	x1
7	LATERAL ESQUERDA SUPERIOR	x1
8	LATERAL DIREITA SUPERIOR	x1
9	PRATELEIRA CENTRAL	x1
10	BASE AÉREO	x1
11	TAMPO	x1

**ACESSÓRIOS REQUERIDOS**

C		04
V		
X		04
Z		08

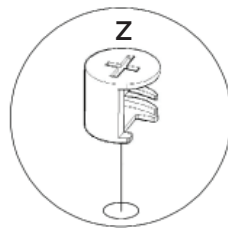
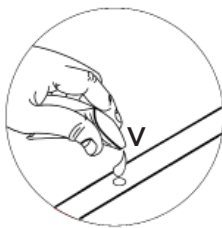
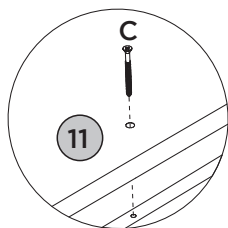
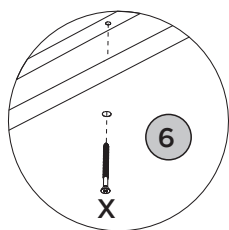
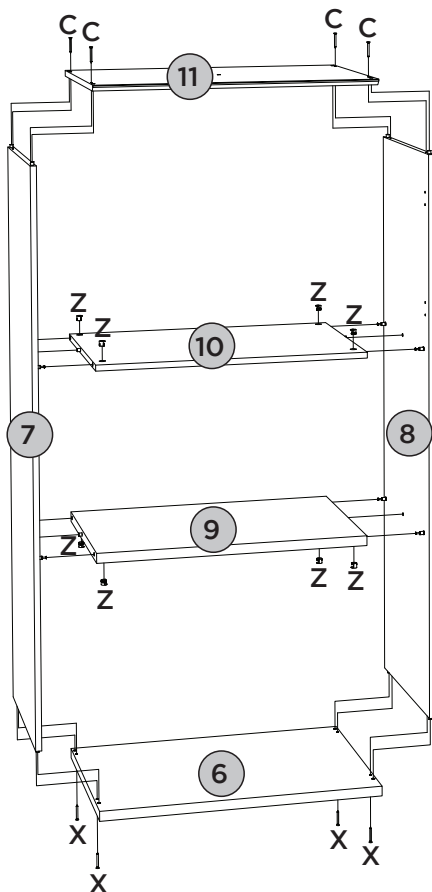
**FERRAMENTAS NECESSÁRIAS**

# PASSO 5

ITM/C643-

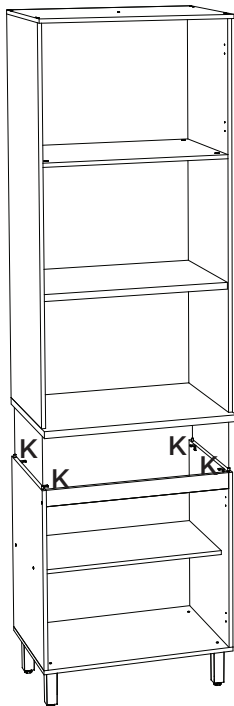

## ACESSÓRIOS REQUERIDOS

G		08
K		04
V		

## FERRAMENTAS NECESSÁRIAS

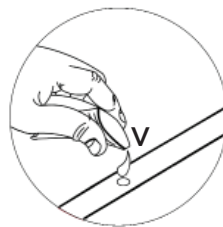
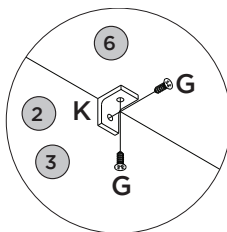
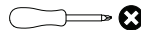

# PASSO 6

## PEÇAS REQUERIDAS

12	FUNDO INFERIOR	x2
13	FUNDO CENTRAL	x2
14	FUNDO SUPERIOR	x1

## ACESSÓRIOS REQUERIDOS

I		80
J		24

## FERRAMENTAS NECESSÁRIAS

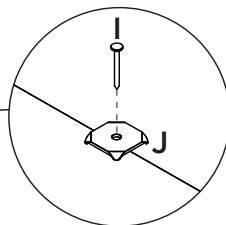
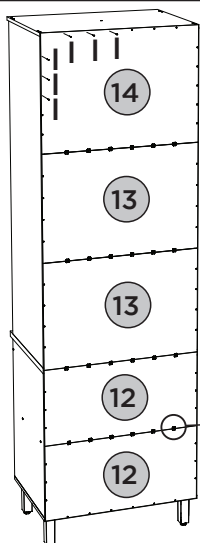
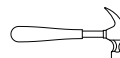

Fixar os pregos a uma distância de 100mm de um para outro.

Fijar las uñas a un distancia de 100mm uno a otro.

Fix the nails at a distance of 100mm from one to the other



## PEÇAS REQUERIDAS

15	PORTA INFERIOR	x2
16	PORTA	x2

## ACESSÓRIOS REQUERIDOS

G		16
N		08

## FERRAMENTAS NECESSÁRIAS

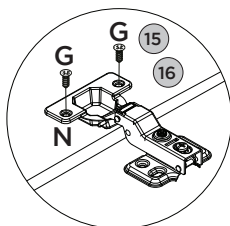
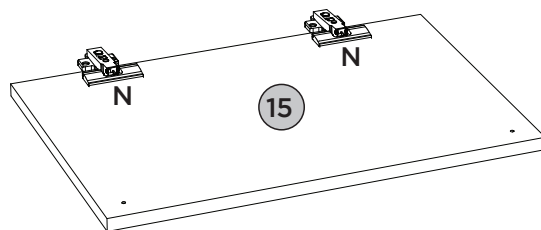
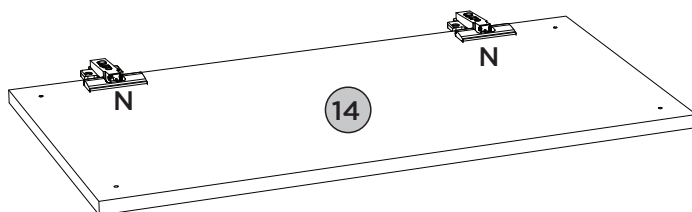
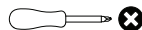







# PASSO 8

ITM/C643-

## PEÇAS REQUERIDAS

15	PORTA INFERIOR	x2
16	PORTA	x2







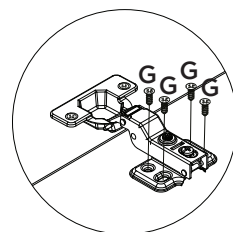
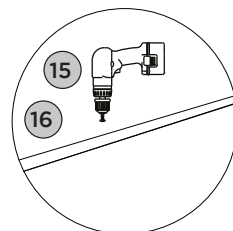
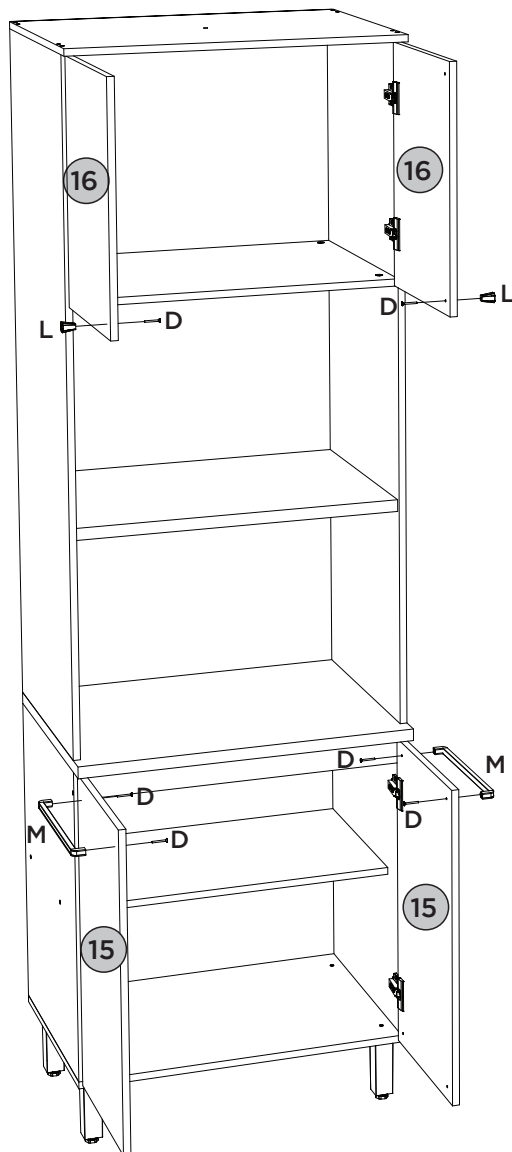
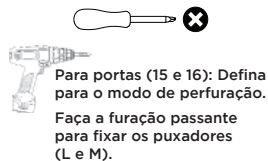



## ACESSÓRIOS REQUERIDOS

D			06
G			32
L			02
M			02

## FERRAMENTAS NECESSÁRIAS



ACESSÓRIOS REQUERIDOS

A		01	S		16
G		02	T		12
P		01	U		03
Q		01	W		01
R		01			

FERRAMENTAS NECESSÁRIAS



Para parede: Ajustar no modo perfuração  
Para peça (11): Usar torque 5

Pesos máximos recomendados com carga distribuída  
Peso máximo recomendado con la carga distribuida  
Recommended maximum weight with distributed load.

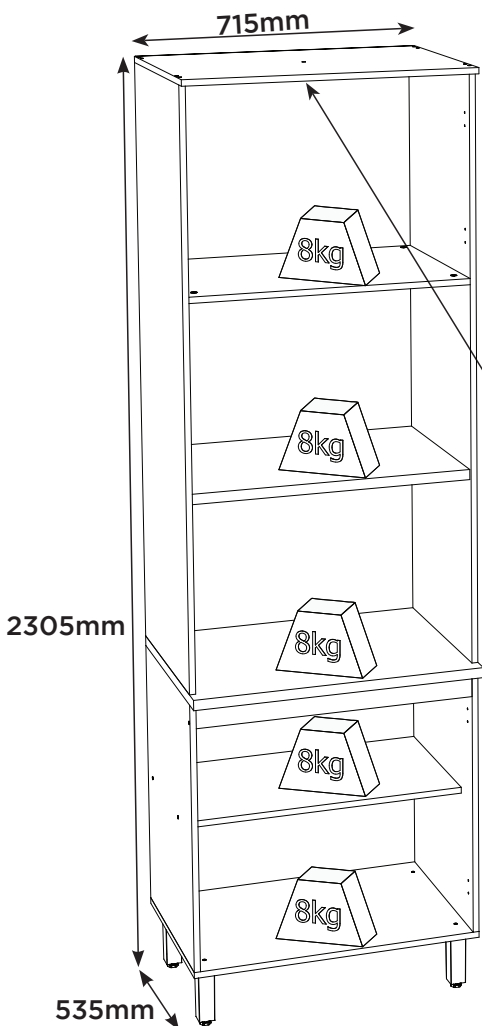

PERFECT CORRECTION  
CORRECCIÓN PERFECTA

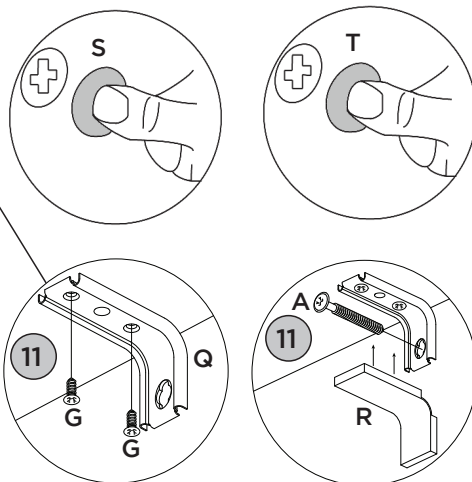
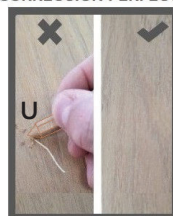

RECOMENDAÇÃO

Para fixar o móvel na parede usar o suporte de fixação (Q), o parafuso 4,0x14mm CHT (G), a Bucha 8mm (P) e o parafuso 5,0x50mm FLA (A).

RECOMENDACIÓN

Para conectar el móvil a la pared con el soporte (Q), tornillo 4,0x14mm CHT (G), el casquillo de 8 mm (P) y el 5,0 x50mm tornillo FLA (A).

RECOMMENDATION

To fix the furniture to the wall use the fixing bracket (Q), the 4,0x14mm CHT (G) screw, the 8mm bushing (P) and the 5.0x50mm FLA screw (A).

**Produto Concluído**  
**Producto terminado**  
**Finished Product**

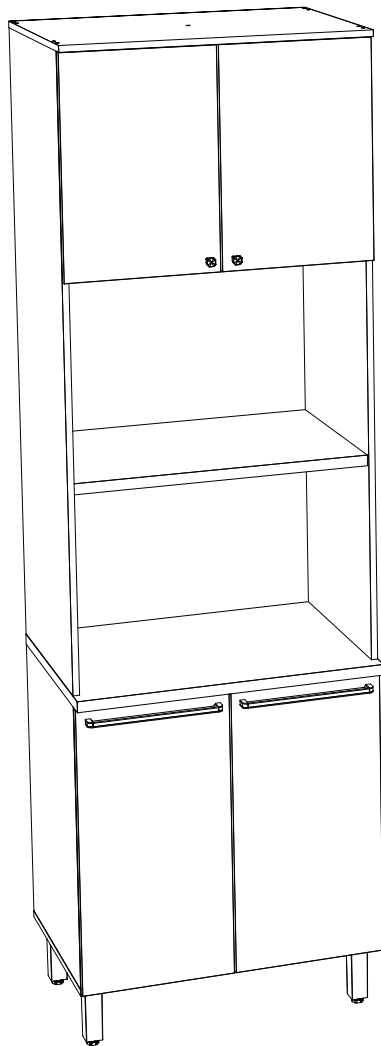

**HENN**Ind. e Com. de Móveis Henn  
Mondai - SC - Brasil

☎ +55 49 3674.3500

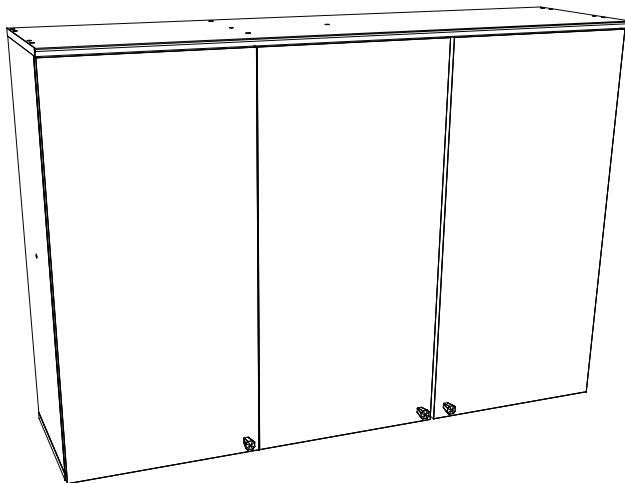
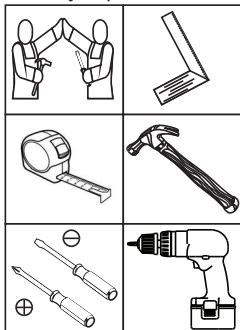
📷 📱 @moveishenn  
www.henn.com.br**INSTRUÇÕES DE  
MONTAGEM**INSTRUCCIONES DE MONTAJE  
ASSEMBLY INSTRUCTIONS**Aereo 03 Portas 1200mm Requite |**  
**Aire 03 Puertas 1200mm Requite | Air 03 Doors 1200mm Requite****C636-128 Nature**  
**C636-217 Nature/Areia****Requisitos para montagem**  
**Requisitos para la montaje**  
**Assembly Requirements**

Imagens meramente ilustrativas,  
não acompanha o produto.  
Imágenes ilustrativas, no incluidas  
con el producto.  
Illustrative images, not included  
with the product.

**AVISO**

Para limpeza de seu móvel, use uma franela seca ou umedecida, e não utilize produtos químicos que possam danificar seu produto.

**SISTEMA DE MONTAGEM**

O sistema de montagem dos produtos, funciona de acordo com a ordem crescente dos números indicados no desenho. Ex: 01, 02, 03, 04... até a conclusão da montagem.

**ASSISTÊNCIA TÉCNICA**

Para solicitação de Assistência Técnica você consumidor deverá entrar em contato com o Lojista o qual você realizou a compra deste produto e solicitar a assistência técnica das peças avariadas. A garantia abrange todas as peças, partes e componentes que eventualmente venham apresentar defeito de fabricação no prazo de 03 (três) meses, contando a partir da entrega do produto ao consumidor, mediante nota fiscal de compra. Se houver qualquer alteração na estrutura do produto ou ocorrer defeito por negligência do montador/consumidor em relação a instrução de montagem e manuseio, não será fornecido assistência técnica gratuita.

**ADVERTENCIA**

Para limpieza de su móvil, use una franela seca o húmeda, y no utilice productos químicos que puedan dañar su producto.

**SISTEMA DE MONTAJE**

El sistema de montaje de los productos funciona de acuerdo con el orden creciente de los números indicados en el dibujo. Ej.: 01, 02, 03, 04... hasta la conclusión del montaje.

**ASISTENCIA TÉCNICA**

Para solicitar Asistencia Técnica, el consumidor debe comunicarse con el Comercio que usted realizó la compra de este producto y solicita asistencia técnica para las partes dañadas. La garantía cubre todas las partes, piezas y componentes que eventualmente puedan presentar defecto de fabricación en el plazo de 03 (tres) meses, contados a partir de la entrega del producto al consumidor, mediante factura de compra. Si se produce algún cambio en la estructura del producto o se produce un defecto por negligencia del montador/consumidor en relación con las instrucciones de montaje y manipulación, no se prestará asistencia técnica gratuita.

**NOTICE**

To clean your furniture, use a dry or wet cloth, and do not use chemicals that may damage your product.

**ASSEMBLY SYSTEM**

The products' assembly system works according to the increasing order of the indicated numbers. For example: 01, 02, 03, 04 ... to the end of the assembly.

**TECHNICAL ASSISTANCE**

To request Technical Assistance, the consumer must contact the retailer from whom you purchased this product and request technical assistance for the damaged parts. The warranty covers all parts, parts and components that may eventually present a manufacturing defect within a period of 03 (three) months, counting from the delivery of the product to the consumer, by means of a purchase invoice. If there is any change in the structure of the product or defect occurs due to negligence of the assembler/consumer in relation to the assembly and handling instruction, free technical assistance will not be provided.

## ACESSÓRIOS | ACCESORIOS | ACCESSORIES

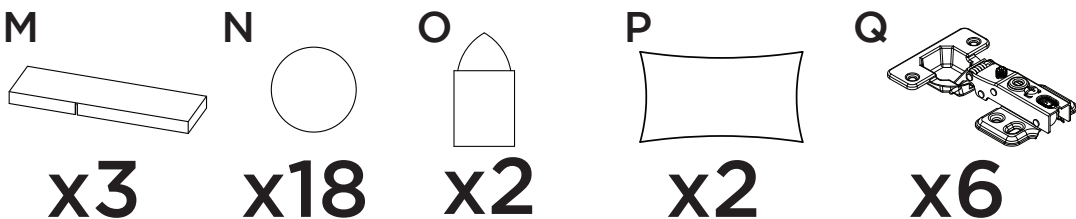
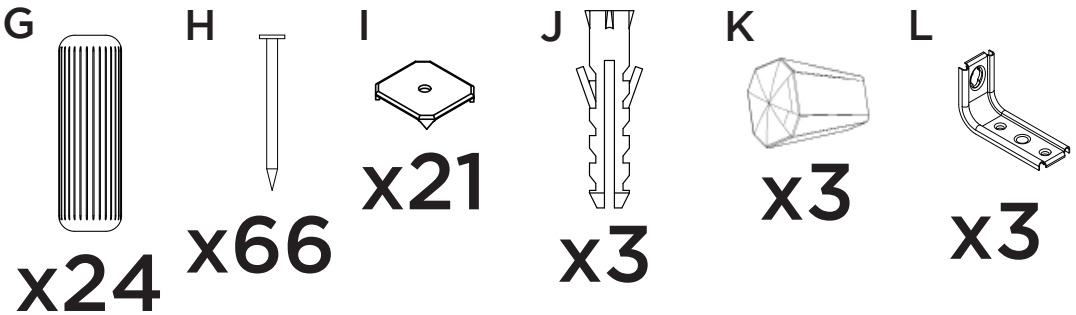
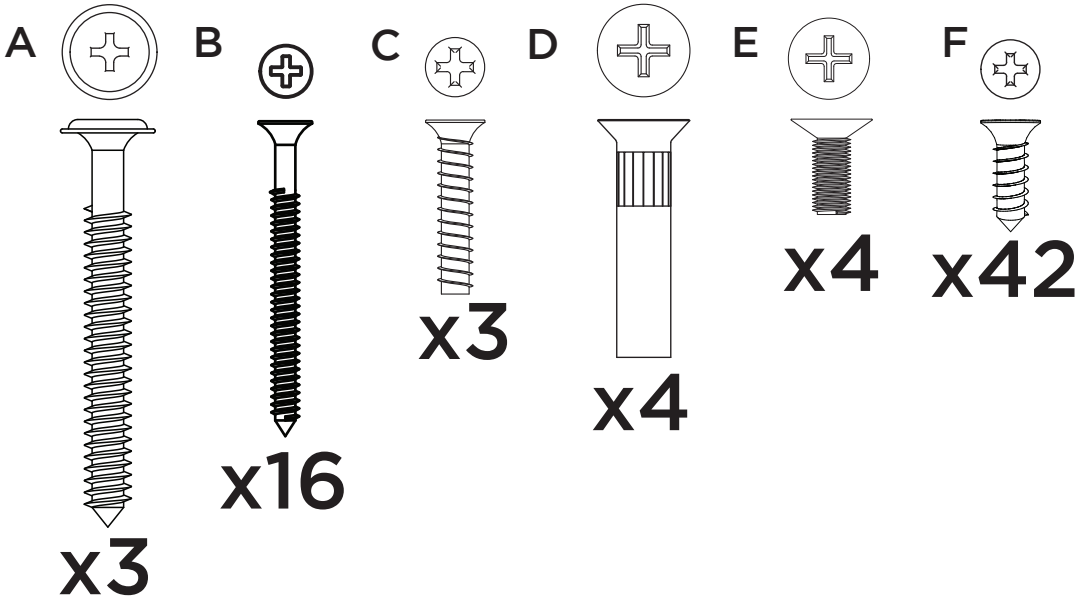

 Os parafusos (D/E) devem ser usados somente quando este módulo for acoplado a outro módulo componível Henn.

 Los tornillos (D/E) se debe utilizar sólo cuando el módulo está conectado a otro módulo componible Henn.

 Screws (D/E) are to be used only when this module is mated to another Henn buildable module.

Parafusos em escala  
Tornillos escalados  
Scaled screws

1:1

## LISTA DE PEÇAS | LISTA DE PIEZAS | LIST OF PIECES

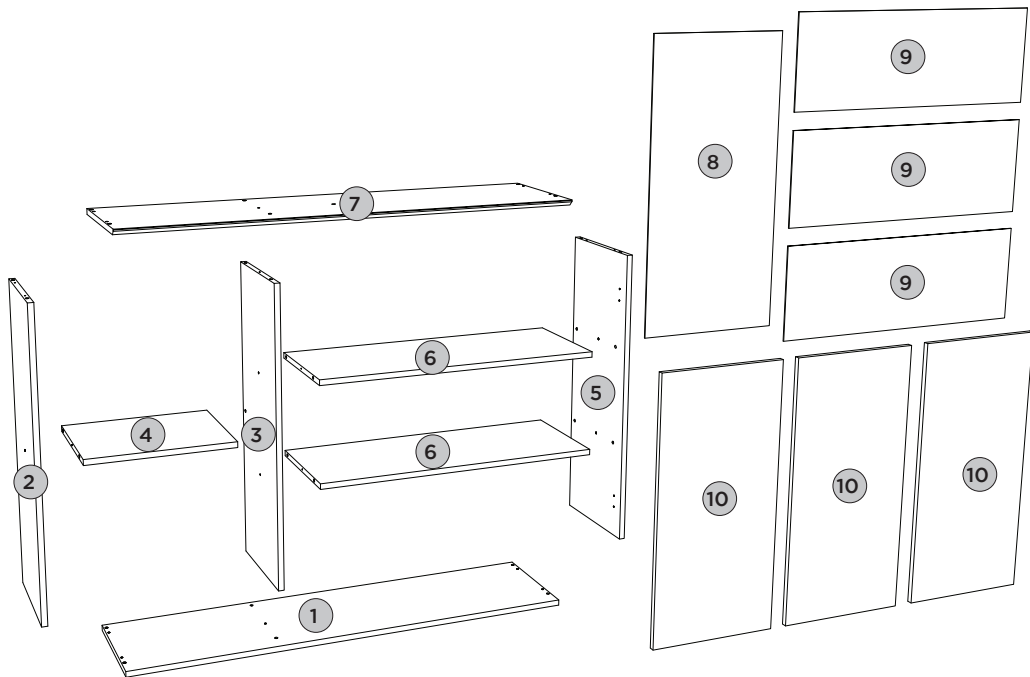

Item	Caixa Caja Box	Qty Ctd Qty	Descrição Descripción Description	Dimensões (mm)   Dimensiones (mm)   Dimensions (mm)		
				Comprimento Largo Length	Largura Ancho Width	Espessura Grosor Thickness
1	1/1	1	BASE   BASE   BASE	1200	295	15
2	1/1	1	LATERAL ESQUERDA   LATERAL IZQUIERDA   LEFT SIDE	800	295	15
3	1/1	1	DIVISÃO   DIVISIÓN   DIVISION	800	295	15
4	1/1	1	PRATELEIRA MENOR   ESTANTE MÁS PEQUEÑO   SMALLER SHELF	382	295	15
5	1/1	1	LATERAL DIREITA   LATERAL DERECHA   RIGHT SIDE	800	295	15
6	1/1	2	PRATELEIRA   ESTANTE   SHELF	772	295	15
7	1/1	1	TAMPO   CUBRIR   COVER	1200	322	15
8	1/1	1	FUNDO LATERAL   FONDO LATERAL   SIDE BACKGROUND	824	401	3
9	1/1	3	FUNDO   FONDO   BACKGROUND	791	274	3
10	1/1	3	PORTA   PUERTA   DOOR	813	396	15



# PASSO 1

ITM/C636-

## PEÇAS REQUERIDAS

2	LATERAL ESQUERDA	x1
3	DIVISÃO	x1
4	PRATELEIRA MENOR	x1
5	LATERAL DIREITA	x1
6	PRATELEIRA	x2

## ACESSÓRIOS REQUERIDOS

G		24
P		

## FERRAMENTAS NECESSÁRIAS



Utilizar o sachê de cola (P) em todas as cavilhas (G) do produto.

Con el pegamento sobre (P) en todos los pernos (G) producto.

Use the glue sachet (P) on all the pegs (G) of the product.

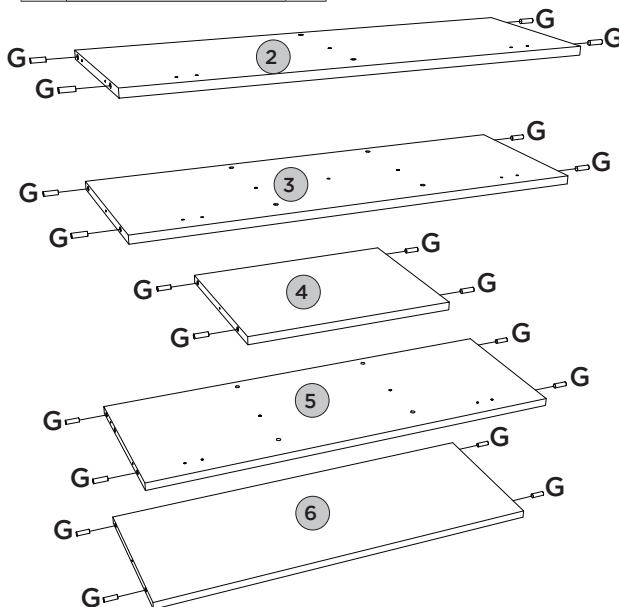



# PASSO 2

## PEÇAS REQUERIDAS

1	BASE	x1
2	LATERAL ESQUERDA	x1
3	DIVISÃO	x1
4	PRATELEIRA MENOR	x1

## ACESSÓRIOS REQUERIDOS

B		05
P		

## FERRAMENTAS NECESSÁRIAS

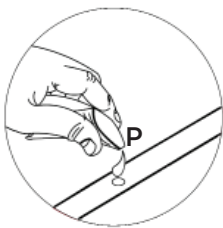
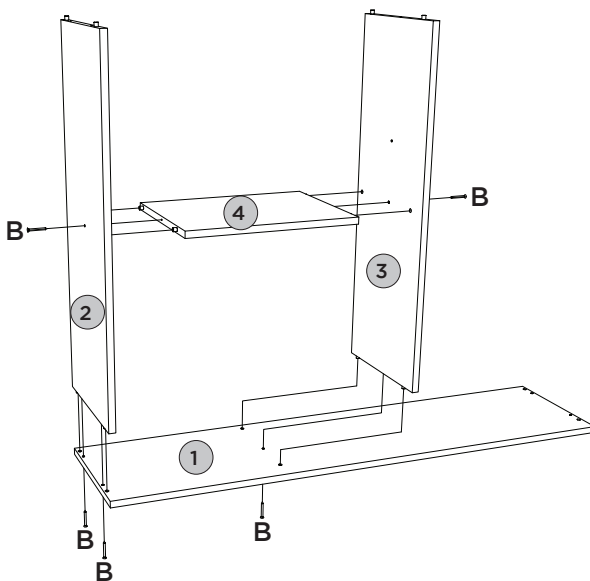
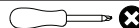







# PASSO 3

ITM/C636-

## PEÇAS REQUERIDAS

5	LATERAL DIREITA	x1
6	PRATELEIRA	x2
7	TAMPO	x1

## ACESSÓRIOS REQUERIDOS

B			11
P			

## FERRAMENTAS NECESSÁRIAS

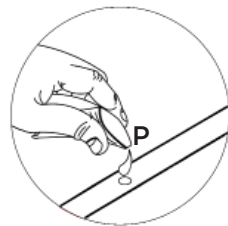
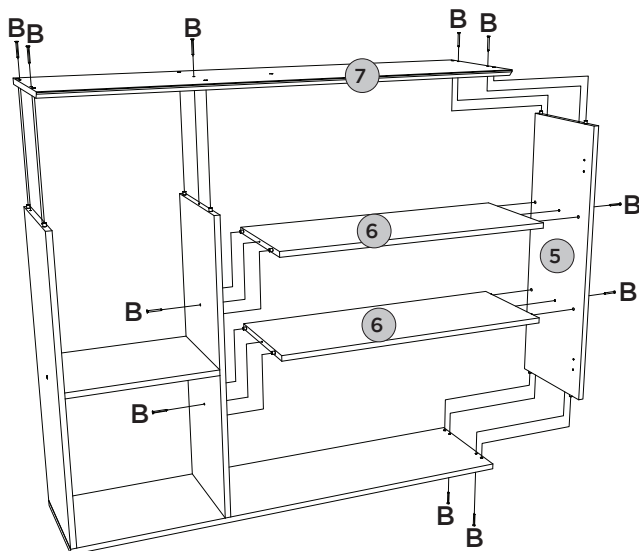
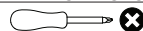



# PASSO 4

## PEÇAS REQUERIDAS

8	FUNDO LATERAL	x1
9	FUNDO	x3

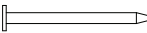
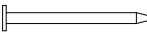
## ACESSÓRIOS REQUERIDOS

H			66
I			21

## FERRAMENTAS NECESSÁRIAS

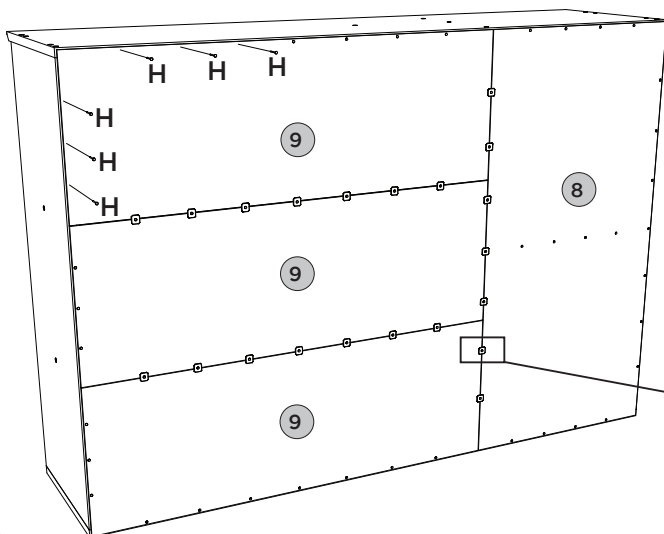
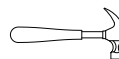

Fixar os pregos a uma distância de 100mm de um para outro.

Fijar las uñas a un distancia de 100 mm uno a otro.

Fix the nails at a distance of 100mm from one to the other

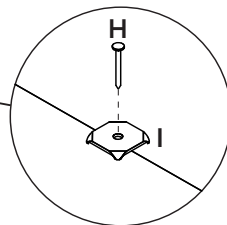



# PASSO 5

ITM/C636-

## PEÇAS REQUERIDAS

10	PORTA	x3
----	-------	----

## ACESSÓRIOS REQUERIDOS

F		12
Q		06

## FERRAMENTAS NECESSÁRIAS

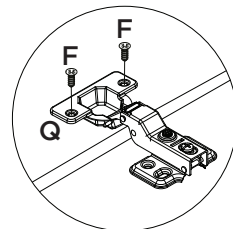
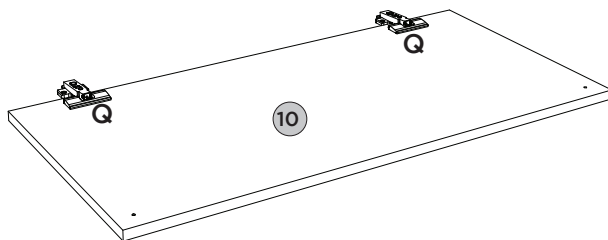
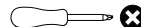



# PASSO 6

## PEÇAS REQUERIDAS

10	PORTA	x3
----	-------	----

## ACESSÓRIOS REQUERIDOS

C		03
F		24
K		03

## FERRAMENTAS NECESSÁRIAS



Para portas (10): Defina para o modo de perfuração.

Faça a furação passante para fixar os puxadores (K).

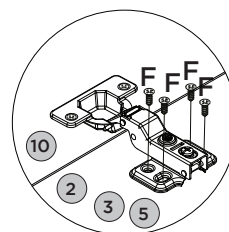
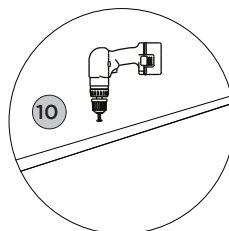
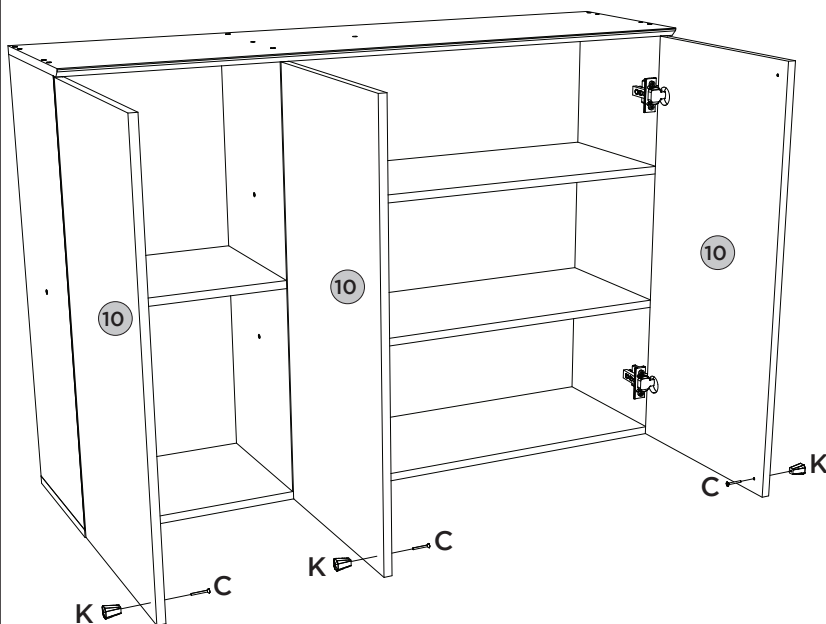

ACESSÓRIOS REQUERIDOS

FERRAMENTAS NECESSÁRIAS

A		03
F		06
J		03
L		03

M		03
N		18
O		02
R	<b>HENN</b>	01

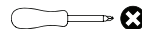

Pesos máximos recomendados com carga distribuída  
 Peso máximo recomendado con la carga distribuida  
 Recommended maximum weight with distributed load.

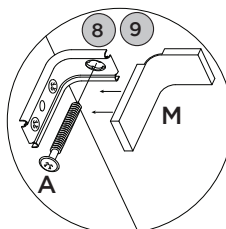
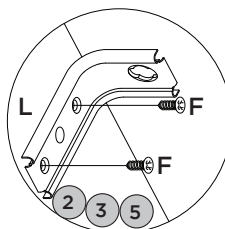
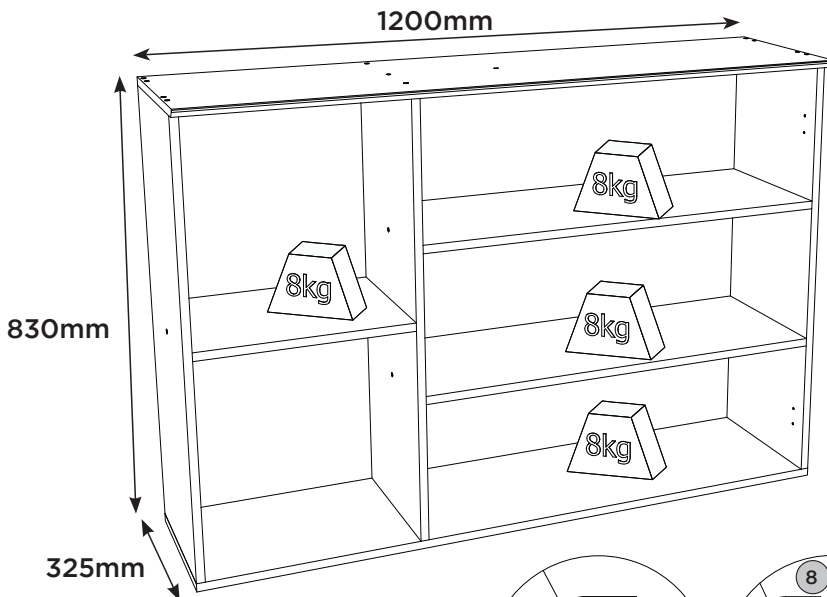

PERFECT CORRECTION  
 CORRECCIÓN PERFECTA

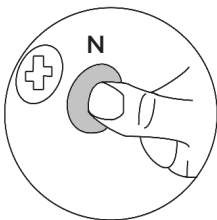
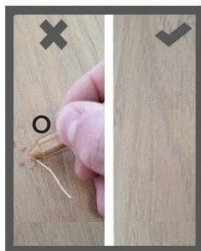

RECOMENDAÇÃO

Para fixar o móvel na parede usar o suporte de fixação (L), o parafuso 4,0x14mm CHT (F), a Bucha 8mm (J) e o parafuso 5,0x50mm FLA (A).

RECOMENDACIÓN

Para conectar el móvil a la pared con el soporte (L), tornillo 4,0x14mm CHT (F), el casquillo de 8mm (J) y el 5,0 x50mm tornillo FLA (A).

RECOMMENDATION

To fix the furniture to the wall use the fixing bracket (L), the 4.0x14mm CHT (F) screw, the 8mm bushing (J) and the 5.0x50mm FLA screw (A).

**Producto Concluído**  
**Producto terminado**  
**Finished Product**

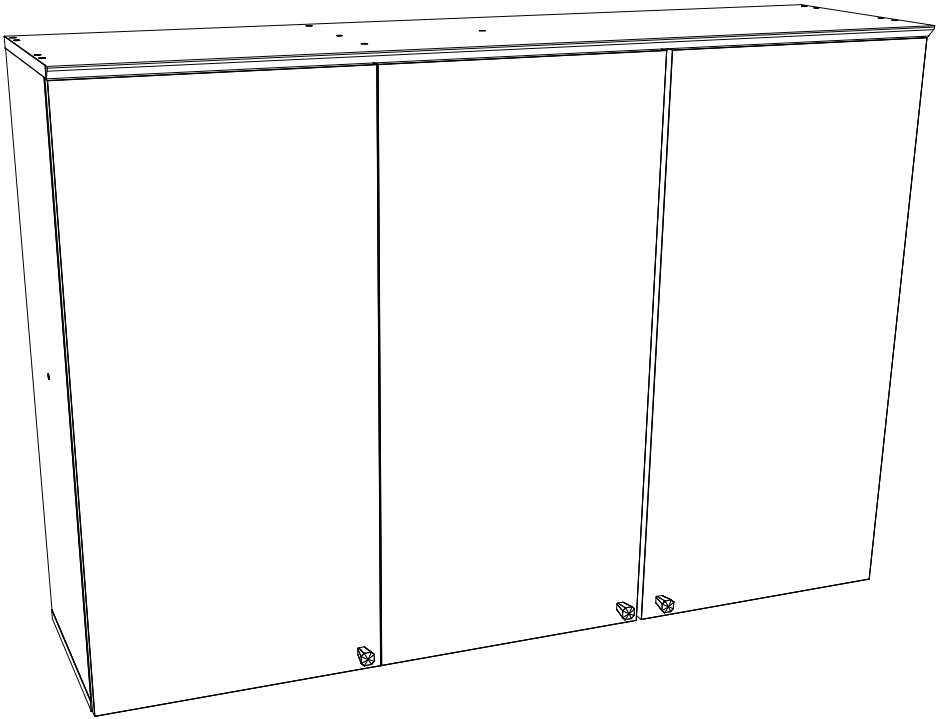

**HENN**Ind. e Com. de Móveis Henn  
Mondai - SC - Brasil

☎ +55 49 3674.3500

📧 @moveishenn  
www.henn.com.br**INSTRUÇÕES DE  
MONTAGEM**INSTRUCCIONES DE MONTAJE  
ASSEMBLY INSTRUCTIONS**Balcão Pia 02 Gavetas 03 Portas Requinte |**  
Pia Contador 02 Cajones 03 Puertas Requinte |  
Balcony Pia 02 Drawers 03 Doors Requinte

C640-217 Nature/Areia

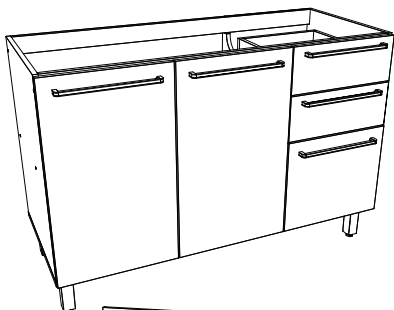
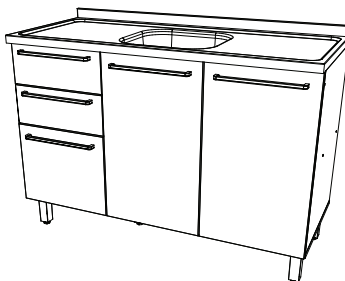
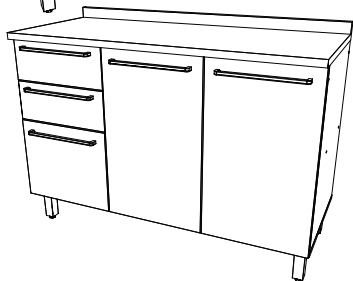
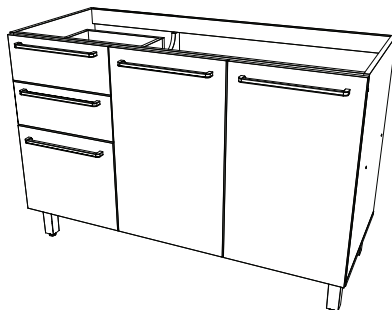
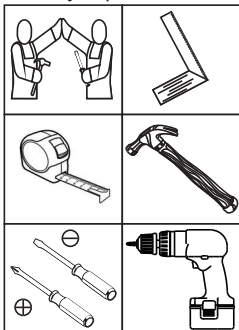
Opção 01  
Opción 01  
Option 01Opção 02  
Opción 02  
Option 02Requisitos para montagem  
Requisitos para la montaje  
Assembly RequirementsImagens meramente ilustrativas,  
não acompanha o produto.  
Imágenes ilustrativas, no incluidas  
con el producto.  
Illustrative images, not included  
with the product.**AVISO**

Para limpeza de seu móvel, use uma flanela seca ou umedecida, e não utilize produtos químicos que possam danificar seu produto.

**SISTEMA DE MONTAGEM**

O sistema de montagem dos produtos, funciona de acordo com a ordem crescente dos números indicados no desenho. Ex: 01, 02, 03, 04... até a conclusão da montagem.

**ASSISTÊNCIA TÉCNICA**

Para solicitação de Assistência Técnica você consumidor deverá entrar em contato com o Lojista a qual você realizou a compra deste produto e solicitar a assistência técnica das peças avariadas. A garantia abrange todas as peças, partes e componentes que eventualmente venham apresentar defeito de fabricação no prazo de 03 (três) meses, contando a partir da entrega do produto ao consumidor, mediante nota fiscal de compra. Se houver qualquer alteração na estrutura do produto ou ocorrer defeito por negligência do montador/consumidor em relação a instrução de montagem e manuseio, não será fornecido assistência técnica gratuita.

**ADVERTENCIA**

Para limpieza de su móvil, use una flanela seca o húmeda, y no utilice productos químicos que puedan dañar su producto.

**SISTEMA DE MONTAJE**

El sistema de montaje de los productos funciona de acuerdo con el orden creciente de los números indicados en el dibujo. Ej.: 01, 02, 03, 04... hasta la conclusión del montaje.

**ASSISTENCIA TÉCNICA**

Para solicitar Asistencia Técnica, el consumidor debe comunicarse con el Comercio que usted realizó la compra de este producto y solicita asistencia técnica para las partes dañadas. La garantía cubre todas las partes, piezas y componentes que eventualmente puedan presentar defecto de fabricación en el plazo de 03 (tres) meses, contados a partir de la entrega del producto al consumidor, mediante factura de compra. Si se produce algún cambio en la estructura del producto o se produce un defecto por negligencia del montador/consumidor en relación con las instrucciones de montaje y manipulación, no se prestará asistencia técnica gratuita.

**NOTICE**

To clean your furniture, use a dry or wet cloth, and do not use chemicals that may damage your product.

**ASSEMBLY SYSTEM**

The products' assembly system works according to the increasing order of the indicated numbers. For example: 01, 02, 03, 04 ... to the end of the assembly.

**TECHNICAL ASSISTANCE**

To request Technical Assistance, the consumer must contact the retailer from whom you purchased this product and request technical assistance for the damaged parts. The warranty covers all parts, parts and components that may eventually present a manufacturing defect within a period of 03 (three) months, counting from the delivery of the product to the consumer, by means of a purchase invoice. If there is any change in the structure of the product or defect occurs due to negligence of the assembler/consumer in relation to the assembly and handling instruction, free technical assistance will not be provided.

## ACESSÓRIOS | ACCESORIOS | ACCESSORIES

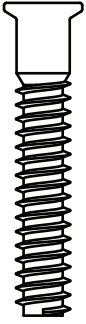

**x5**

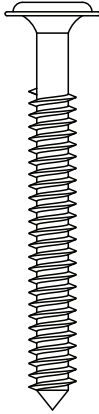

**x2**



**x4**



**x2**



**x14**

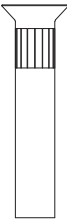

**x6**

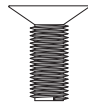

**x6**

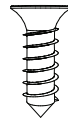

**x98**



**x4**



**x10**

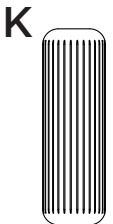

**x32**



**x38**

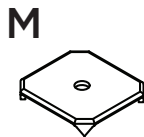

**x13**



Os parafusos (F/G) devem ser usados somente quando este módulo for acoplado a outro módulo componível Henn.



Los tornillos (F/G) se debe utilizar sólo cuando el módulo está conectado a otro módulo componible Henn.



Screws (F/G) are to be used only when this module is mated to another Henn buildable module.

Parafusos em escala  
Tornillos escalados  
Scaled screws **1:1**

## ACESSÓRIOS | ACCESORIOS | ACCESSORIES

N

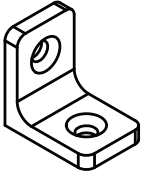

x11

O

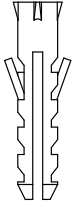

x2

P

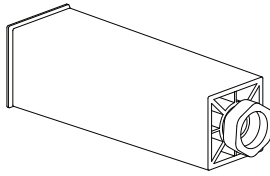

x5

Q

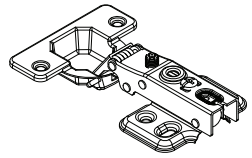

x6

R

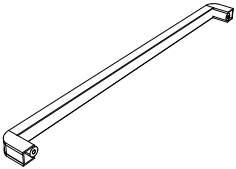

x5

S

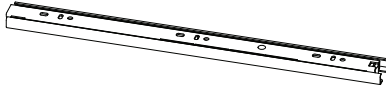

x2

T

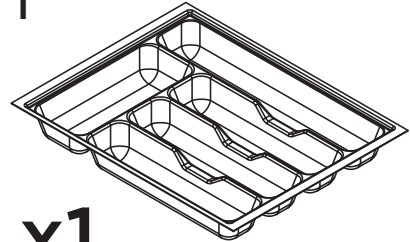

x1

U

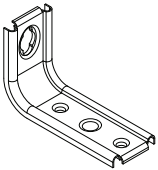

x2

V

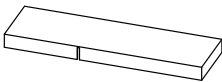

x2

W

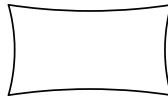

x2

X

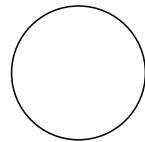

x6

Y



x26

Z

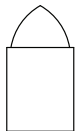

x3

AA



x1

# LISTA DE PEÇAS | LISTA DE PIEZAS | LIST OF PIECES

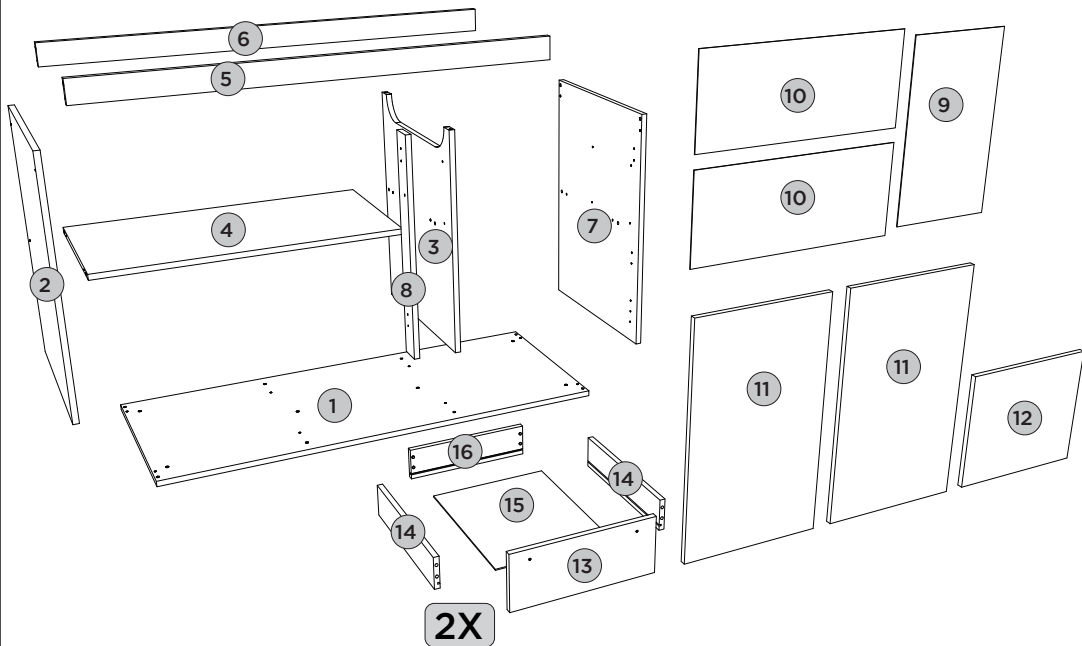

Item	Caixa Caja Box	Qty Ctd Qty	Descrição Descripción Description	Dimensões (mm)   Dimensiones (mm)		
				Comprimento Largo Length	Largura Ancho Width	Espessura Grosor Thickness
1	1/1	01	BASE   BASE   BASE	1200	490	15
2	1/1	01	LATERAL ESQUERDA   LATERAL IZQUIERDA   LEFT SIDE	660	490	15
3	1/1	01	DIVISÃO   DIVISIÓN   DIVISION	600	490	15
4	1/1	01	PRATELEIRA   ESTANTE   SHELF	783	400	15
5	1/1	01	TRAVESSA FRONTAL   TRAVESAÑO FRONTAL   FRONT CROSSBAR	1168	60	15
6	1/1	01	TRAVESSA TRASEIRA   TRAVESAÑO TRASERO   REAR BUMPER	1168	60	15
7	1/1	01	LATERAL DIREITA   LATERAL DERECHA   RIGHT SIDE	660	490	15
8	1/1	01	PILASTRA DA PORTA   PILASTRA PUERTA   PILASTER DOOR	597	60	15
9	1/1	01	FUNDO MENOR   FONDO MENOR   MINOR FUND	672	389	3
10	1/1	02	FUNDO   FONDO   BOTTOM	802	335	3
11	1/1	02	PORTA   PUERTA   DOOR	665	396	15
12	1/1	01	PORTA MENOR   PUERTA MENOR   SMALLER DOOR	396	337	15
13	1/1	02	FRENTE DE GAVETA   FRENTE DE CAJÓN   FRONT OF DRAWER	396	160	15
14	1/1	04	LADO DE GAVETA MENOR   LADO DEL CAJÓN MENOR   SMALLEST DRAWER SIDE	400	90	15
15	1/1	02	FUNDO DE GAVETA   FONDO DE CAJÓN   BOTTOM OF DRAWER	411	326	3
16	1/1	02	RIPA DE TRÁS   MALLA DETRÁS   REAR LATH	345	90	15







# PASSO 1

ITM/C640-

## PEÇAS REQUERIDAS

1	BASE	x1
4	PRATELEIRA	x1
5	TRAVESSA FRONTAL	x1
6	TRAVESSA TRASEIRA	x1

## ACESSÓRIOS REQUERIDOS

A		05
K		08
P		05
W		

## FERRAMENTAS NECESSÁRIAS

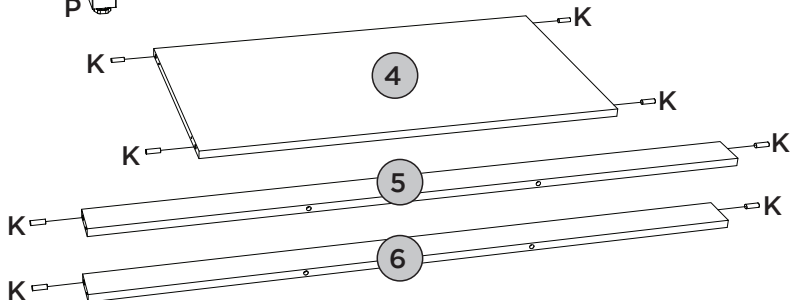
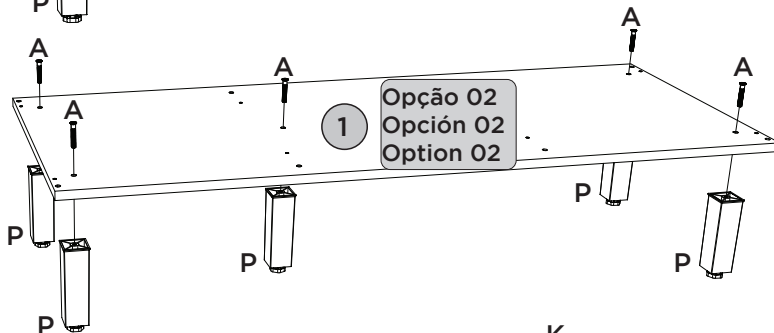
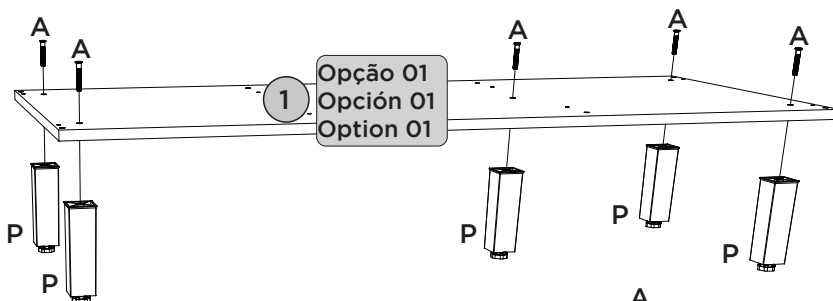
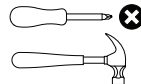

Utilizar o sachê de cola (W) em todas as cavilhas (K) do produto.

Con el pegamento sobre (W) en todos los pernos (K) producto.

Use the glue sachet (W) on all the pegs (K) of the product.

# PASSO 2

ITM/C640-

## PEÇAS REQUERIDAS

2	LATERAL ESQUERDA	x1
3	DIVISÃO	x1
7	LATERAL DIREITA	x1

## ACESSÓRIOS REQUERIDOS

H		12
K		08
S		04
W		

## FERRAMENTAS NECESSÁRIAS

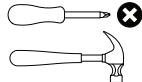

Fixar as correijas nessas furações  
Fijar las diapositivas de estos agujeros  
Fix the slides in these holes

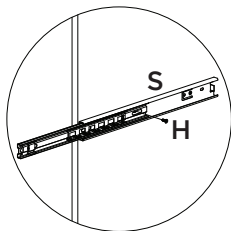
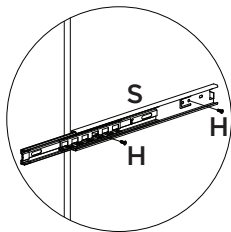
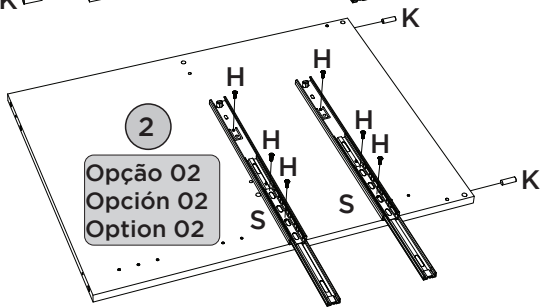
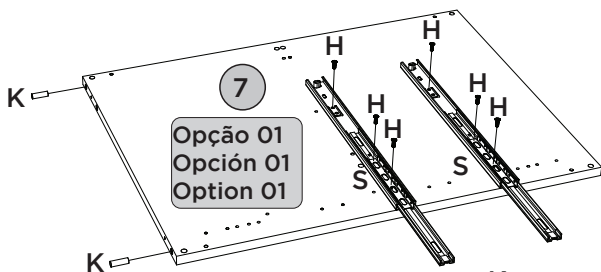
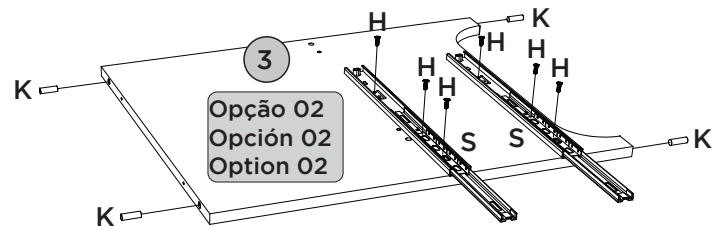
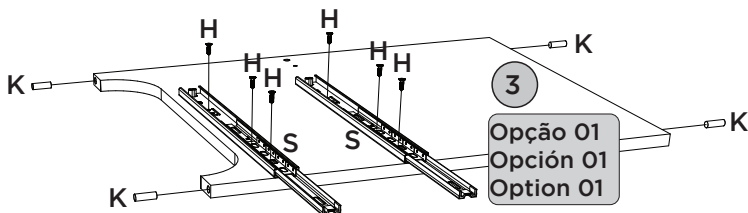
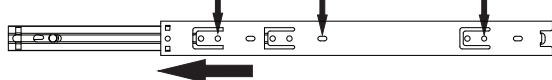

Na Opção 01 a Lateral Esquerda (02) ficará apenas com cavilhas (K), assim como na opção 02 a Lateral Direita (07) ficará apenas com cavilhas (K).

En la Opción 01 el Lado Izquierdo (02) solo tendrá pasadores (K), al igual que en la opción 02 el Lado Derecho (07) solo tendrá pasadores (K).

In Option 01 the Left Side (02) will only have pins (K), just as in option 02 the Right Side (07) will only have pins (K).



# PASSO 3

ITM/C640-

## PEÇAS REQUERIDAS

1	BASE	x1
2	LATERAL ESQUERDA	x1
3	DIVISÃO	x1
4	PRATELEIRA	x1
5	TRAVESSA FRONTAL	x1
6	TRAVESSA TRASEIRA	x1
7	LATERAL DIREITA	x1

## ACESSÓRIOS REQUERIDOS

E		10
W		

## FERRAMENTAS NECESSÁRIAS

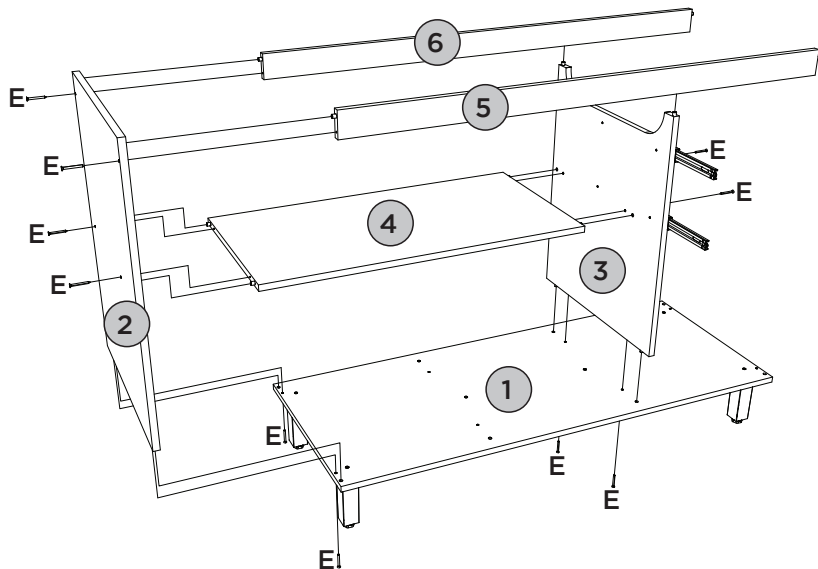
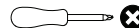

Opção 01  
Opción 01  
Option 01



Opção 02  
Opción 02  
Option 02

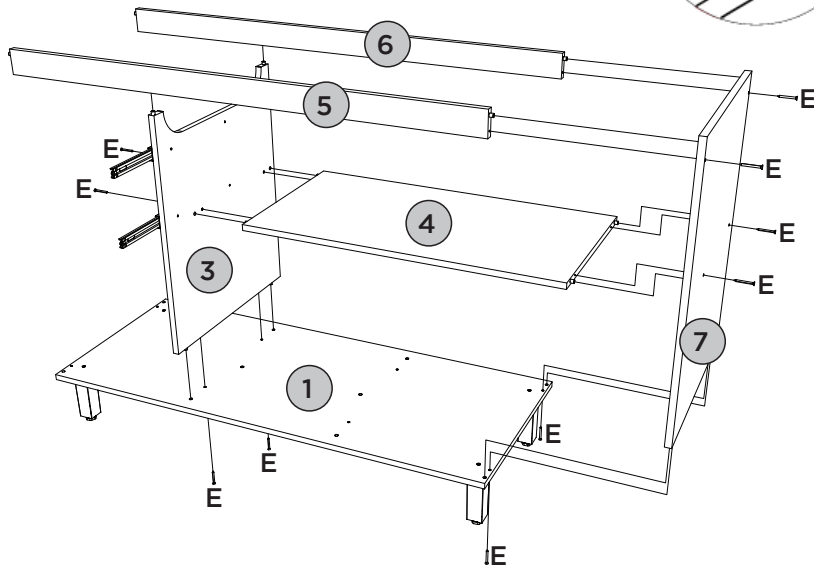





# PASSO 4

ITM/C640-

## PEÇAS REQUERIDAS

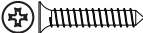
2	LATERAL ESQUERDA	x1
7	LATERAL DIREITA	x1
8	PILASTRA DA PORTA	x1

## ACESSÓRIOS REQUERIDOS

D		02
E		04
H		02
N		01
W		

## FERRAMENTAS NECESSÁRIAS

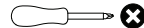



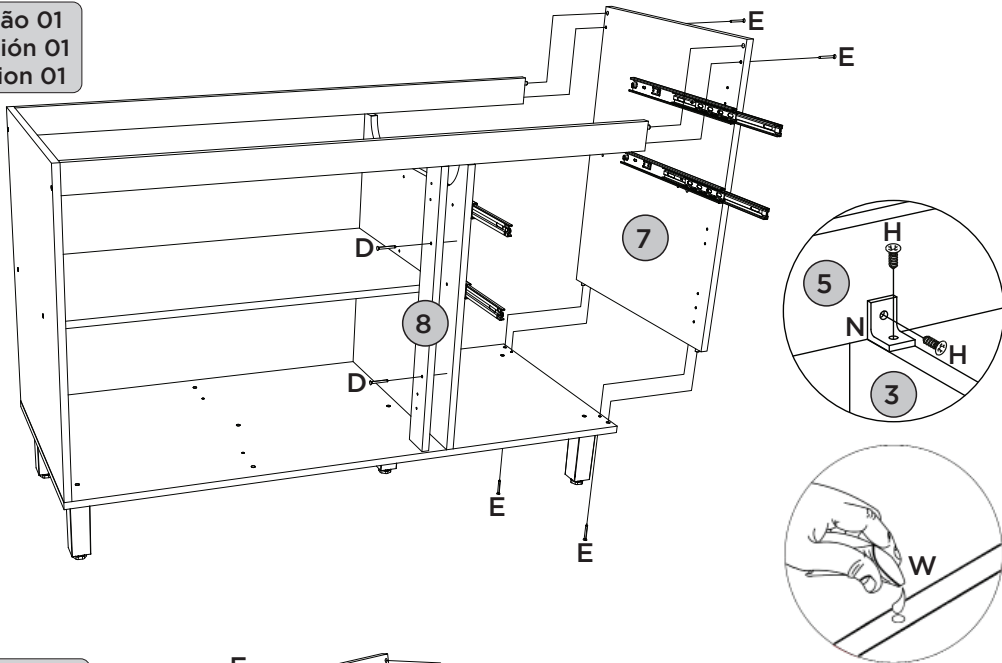

Opção 01  
Opción 01  
Option 01

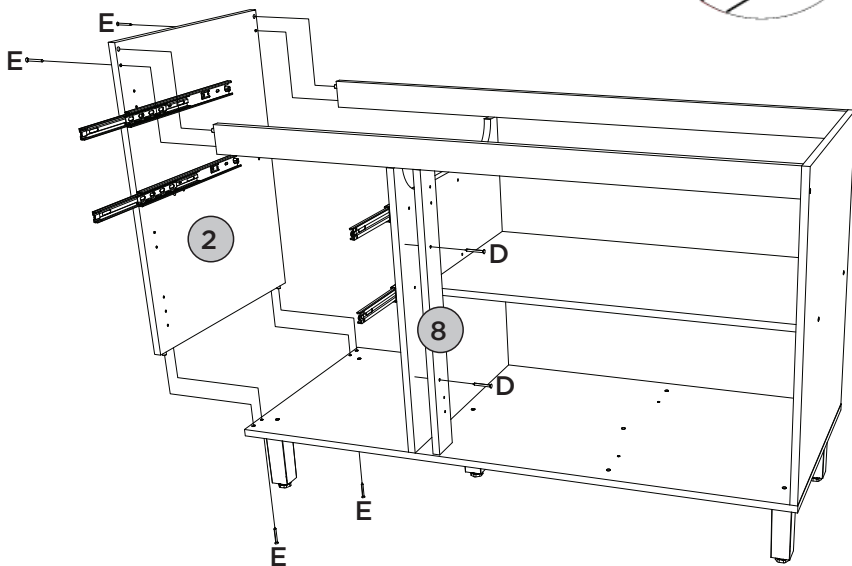

Opção 02  
Opción 02  
Option 02



ACESSÓRIOS REQUERIDOS

C			04
H			12
N			06

FERRAMENTAS NECESSÁRIAS



Esse tampo é opcional e é vendido separadamente (C905-128).

Esta vez es opcional y se vende por separado (C905-128).

This top is optional and is sold separately (C905-128).

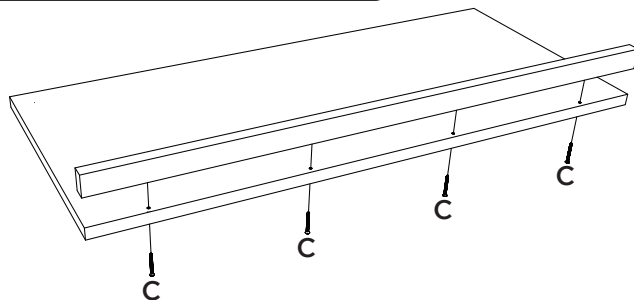

Opção 01  
Opción 01  
Option 01

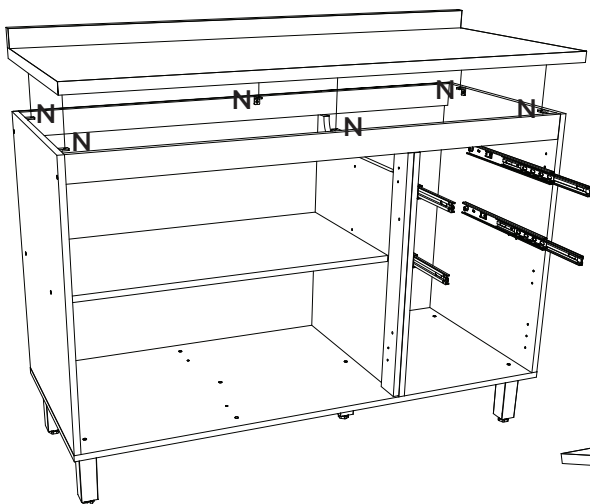

Opção 02  
Opción 02  
Option 02

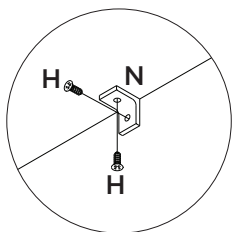
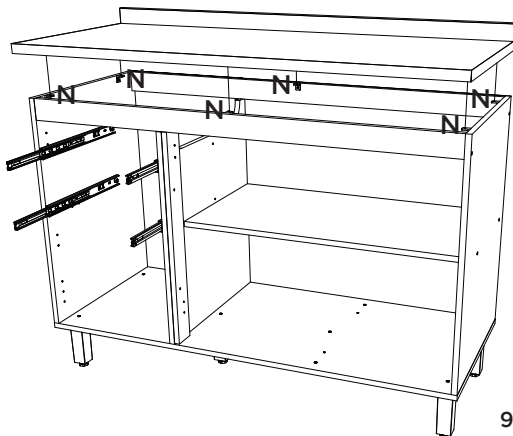



# PASSO 6

ITM/C640-

## PEÇAS REQUERIDAS

9	FUNDO MENOR	x1
10	FUNDO	x2

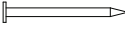
## ACESSÓRIOS REQUERIDOS

H		12
L		38
M		13

## FERRAMENTAS NECESSÁRIAS

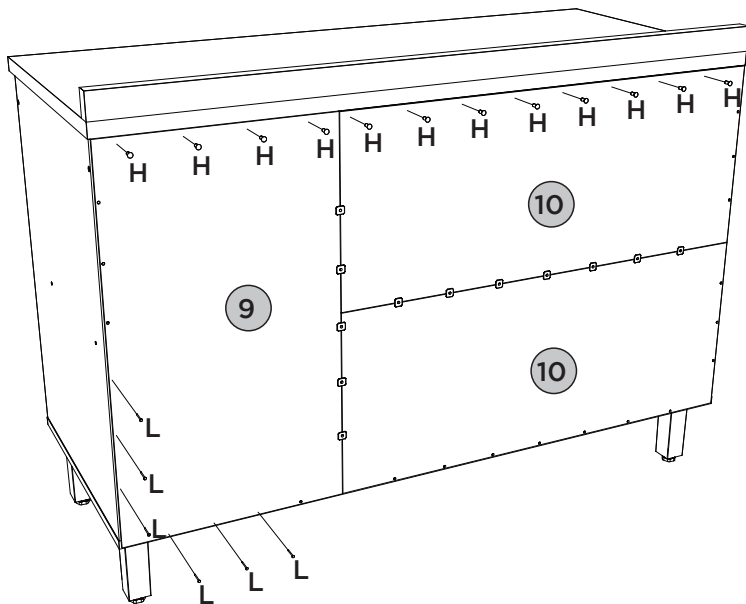
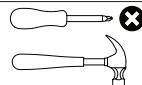

Opção 01  
Opción 01  
Option 01

Opção 02  
Opción 02  
Option 02

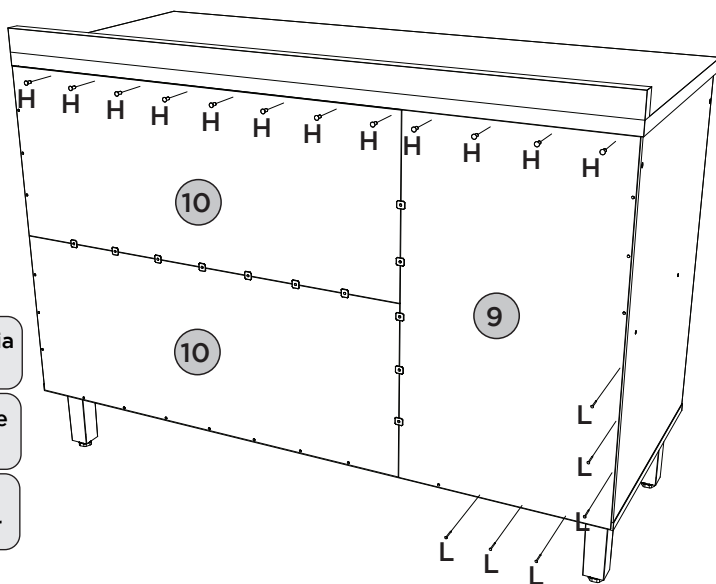

Fixar os pregos a uma distância de 100mm de um para outro.



Fijar las uñas a un distancia de 100mm uno a otro.

Fix the nails at a distance of 100mm from one to the other

## PEÇAS REQUERIDAS

11	PORTA	x2
12	PORTA MENOR	x1

## ACESSÓRIOS REQUERIDOS

H		12
Q		06

## FERRAMENTAS NECESSÁRIAS

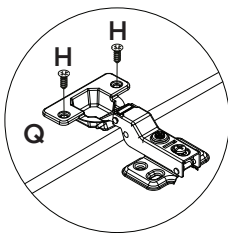
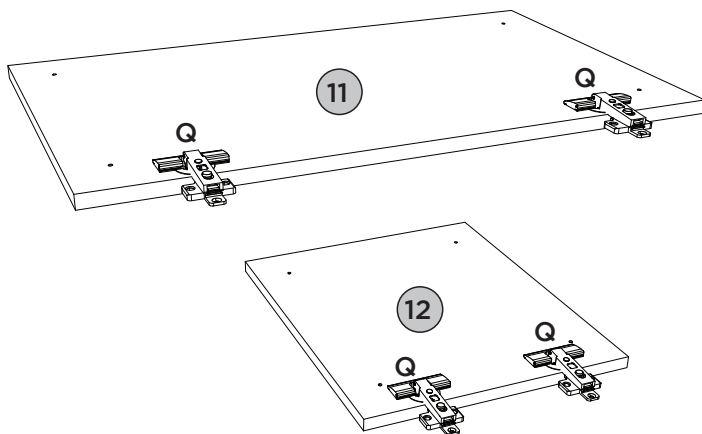
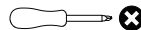



# PASSO 8

ITM/C640-

## PEÇAS REQUERIDAS

11	PORTA	x2
12	PORTA MENOR	x1

## ACESSÓRIOS REQUERIDOS

H		24
J		06
R		03

## FERRAMENTAS NECESSÁRIAS



Para porta (11 e 12): Defina para o modo de perfuração.  
Faça a furação passante para fixar os puxadores (R).

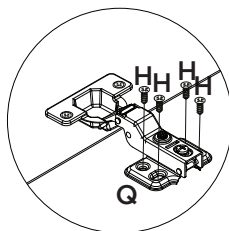
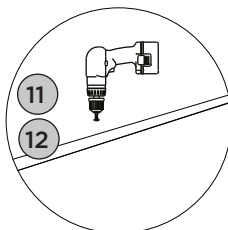
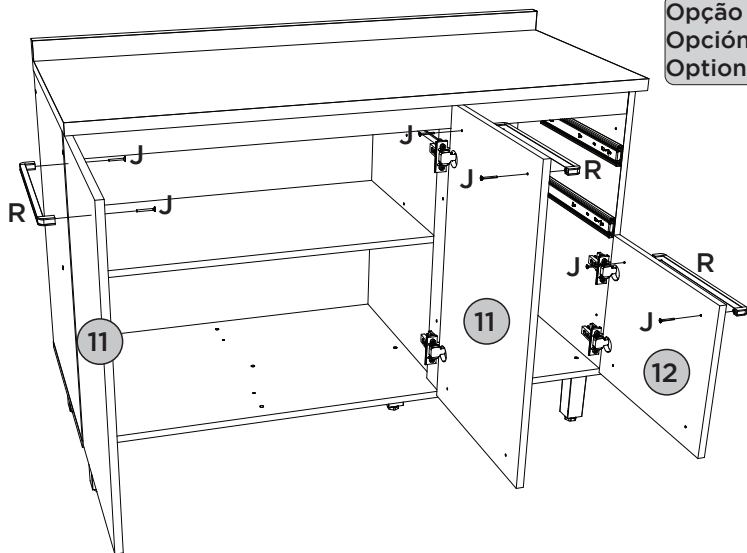

Opção 02  
Opción 02  
Option 02

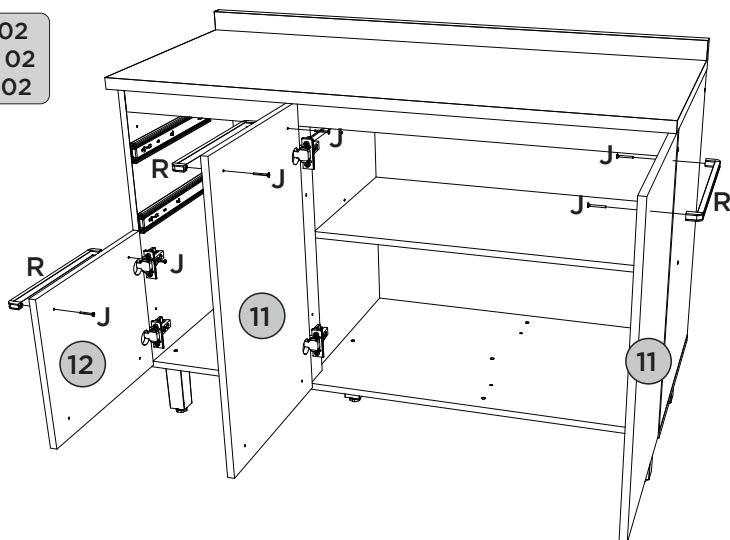





# PASSO 9

ITM/C640-

## PEÇAS REQUERIDAS

13	FRENTE DE GAVETA	x2
14	LADO DE GAVETA	x4
15	FUNDO DE GAVETA	x2

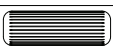
## ACESSÓRIOS REQUERIDOS

H		08
K		16
N		04
W		

## FERRAMENTAS NECESSÁRIAS

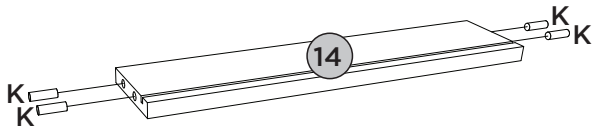
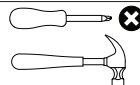

**1º**  
**2X**

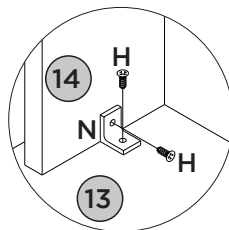
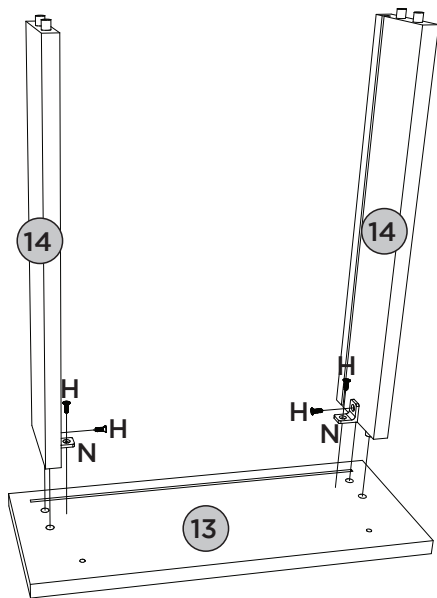

**2º**  
**2X**

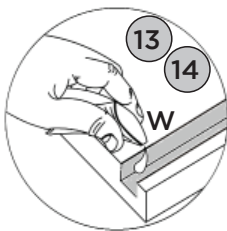
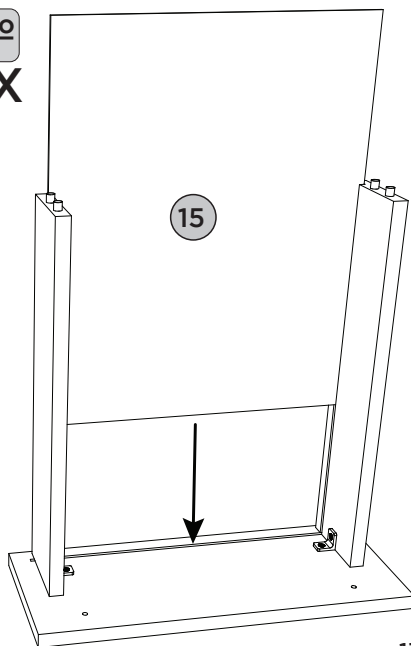

# PASSO 10

ITM/C640-

## PEÇAS REQUERIDAS

16	RIPA DE TRÁS	x2
----	--------------	----

## ACESSÓRIOS REQUERIDOS

H		12
I		04
J		04
R		02
S		04
W		

## FERRAMENTAS NECESSÁRIAS

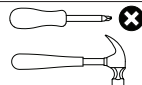

3º  
2X

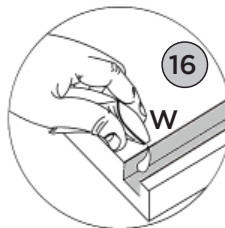
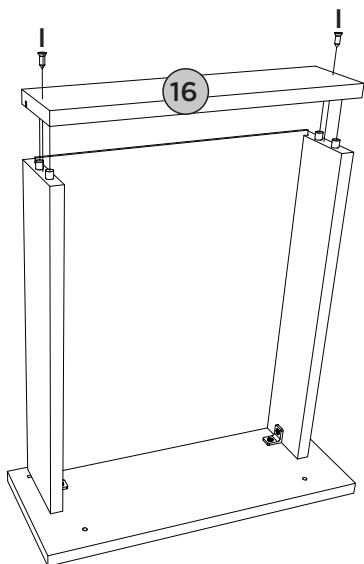

4º  
2X

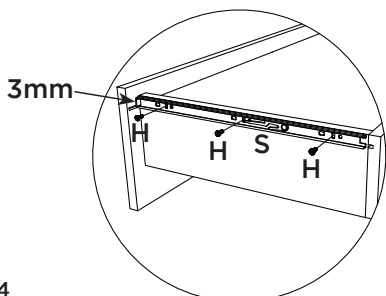
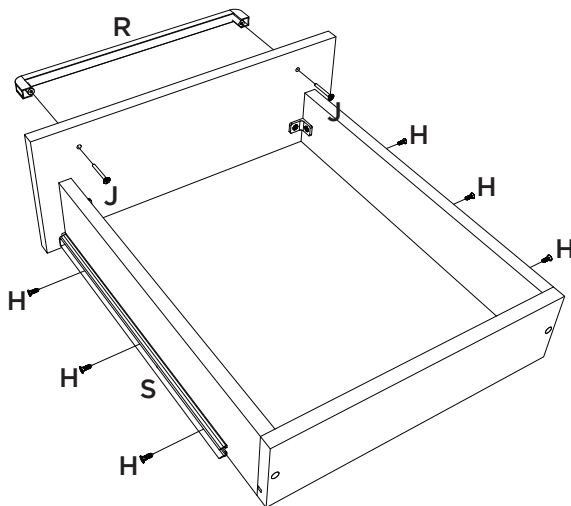

## ACESSÓRIOS REQUERIDOS

B		02	X		06
H		04	Y		26
O		02	Z		03
U		02	AA		01
V		02			

## FERRAMENTAS NECESSÁRIAS



OU

Para parede: Ajustar no modo perfuração.  
Para peça (02 e 07): Usar torque 5.

Pesos máximos recomendados com carga distribuída  
Peso máximo recomendado con la carga distribuida  
Recommended maximum weight with distributed load.

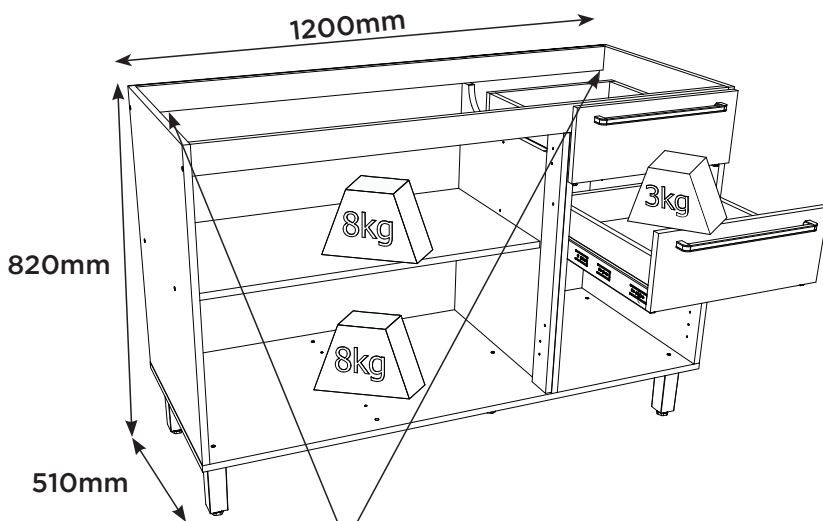

PERFECT CORRECTION  
CORRECCIÓN PERFECTA

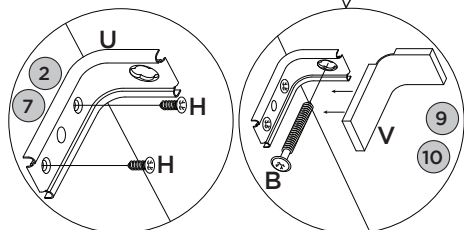
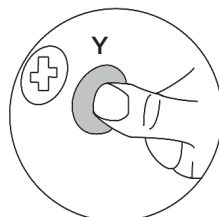
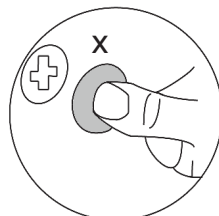
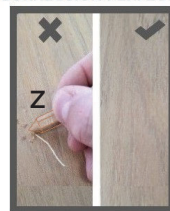

### RECOMENDAÇÃO

Para fixar o móvel na parede usar o suporte de fixação (U), o parafuso 4,0x14mm CHT (H), a Bucha 8mm (O) e o parafuso 5,0x50mm FLA (B).

### RECOMENDACIÓN

Para conectar el móvil a la pared con el soporte (U), tornillo 4,0 x14mm CHT (H), el casquillo de 8 mm (O) y el 5,0 x50mm tornillo FLA (B).

### RECOMMENDATION

To fix the furniture to the wall use the fixing bracket (U), the 4,0x14mm CHT (H) screw, the 8mm bushing (O) and the 5.0x50mm FLA screw (B).

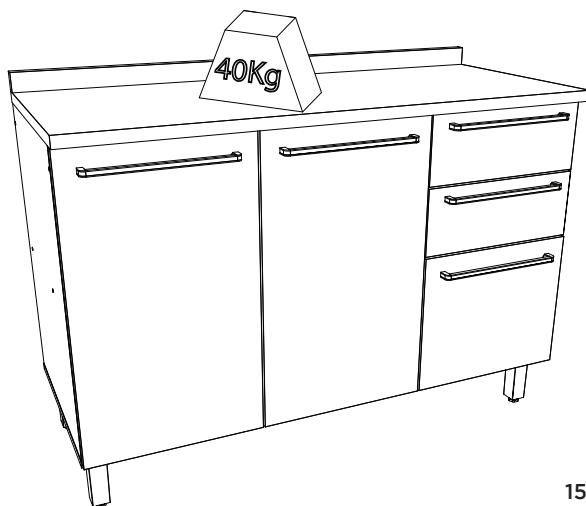

**Producto Concluído**  
**Producto terminado**  
**Finished Product**

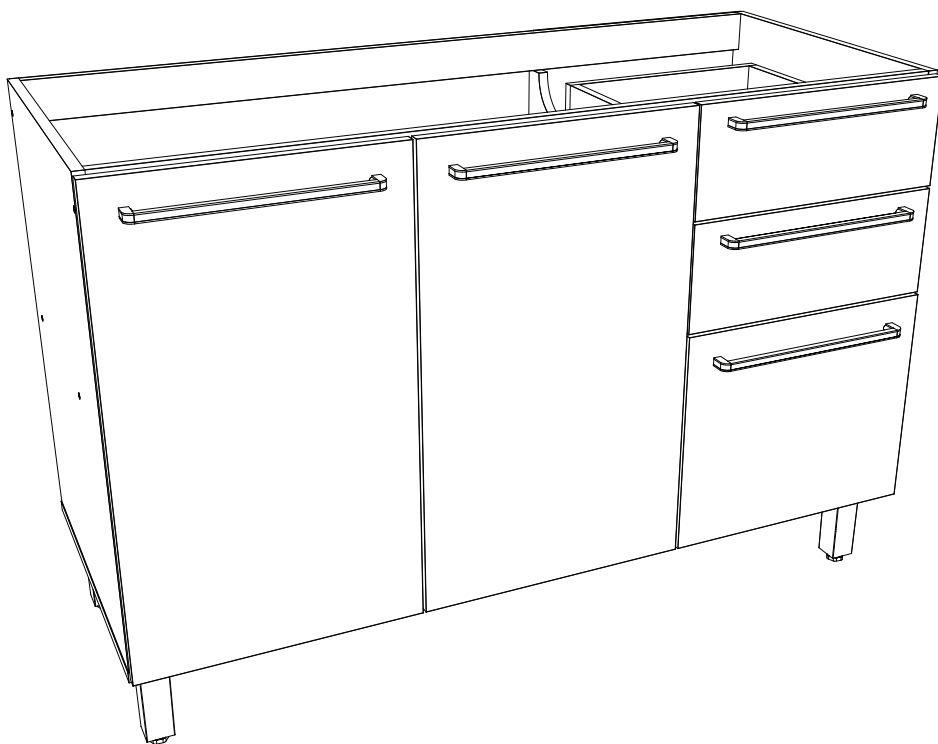

**HENN**Ind. e Com. de Móveis Henn  
Mondai - SC - Brasil

☎ +55 49 3674.3500

📱 @moveishenn  
www.henn.com.br**INSTRUÇÕES DE  
MONTAGEM**INSTRUCCIONES DE MONTAJE  
ASSEMBLY INSTRUCTIONS**Aéreo 01 Porta Basculante 800mm Requite | Aéreo 01  
Puerta Abatible 800mm Requite |  
Aerial 01 Tipper Door 800mm Requite**

C633-128 Nature

C633-217 Nature/Areia HP

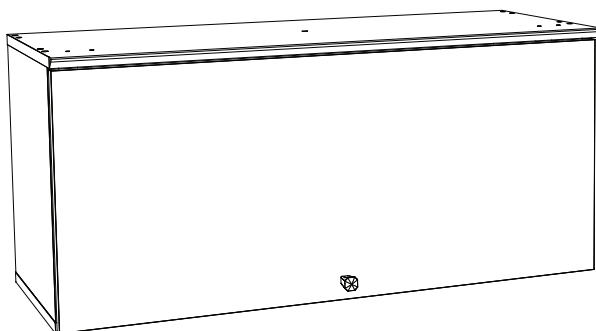
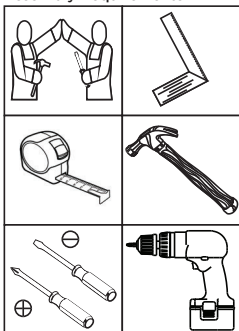
**Requisitos para montagem  
Requisitos para la montaje  
Assembly Requirements**

Imagens meramente ilustrativas,  
não acompanha o produto.  
Imágenes ilustrativas, no incluidas  
con el producto.  
Illustrative images, not included  
with the product.

**AVISO**

Para limpeza de seu móvel, use uma flanela seca ou umedecida, e não utilize produtos químicos que possam danificar seu produto.

**SISTEMA DE MONTAGEM**

O sistema de montagem dos produtos, funciona de acordo com a ordem crescente dos números indicados no desenho. Ex: 01, 02, 03, 04... até a conclusão da montagem.

**ASSISTÊNCIA TÉCNICA**

Para solicitação de Assistência Técnica você consumidor deverá entrar em contato com o Lojista o qual você realizou a compra deste produto e solicitar a assistência técnica das peças avariadas. A garantia abrange todas as peças, partes e componentes que eventualmente venham apresentar defeito de fabricação no prazo de 03 (três) meses, contando a partir da entrega do produto ao consumidor, mediante nota fiscal de compra. Se houver qualquer alteração na estrutura do produto ou ocorrer defeito por negligência do montador/consumidor em relação a instrução de montagem e manuseio, não será fornecido assistência técnica gratuita.

**ADVERTENCIA**

Para limpieza de su móvil, use una franela seca o húmeda, y no utilice productos químicos que puedan dañar su producto.

**SISTEMA DE MONTAJE**

El sistema de montaje de los productos funciona de acuerdo con el orden creciente de los números indicados en el dibujo. Ej.: 01, 02, 03, 04... hasta la conclusión del montaje.

**ASISTENCIA TÉCNICA**

Para solicitar Asistencia Técnica, el consumidor debe comunicarse con el Comercio que usted realizó la compra de este producto y solicita asistencia técnica para las partes dañadas. La garantía cubre todas las partes, piezas y componentes que eventualmente puedan presentar defecto de fabricación en el plazo de 03 (tres) meses, contados a partir de la entrega del producto al consumidor, mediante factura de compra. Si se produce algún cambio en la estructura del producto o se produce un defecto por negligencia del montador/consumidor en relación con las instrucciones de montaje y manipulación, no se prestará asistencia técnica gratuita.

**NOTICE**

To clean your furniture, use a dry or wet cloth, and do not use chemicals that may damage your product.

**ASSEMBLY SYSTEM**

The products' assembly system works according to the increasing order of the indicated numbers. For example: 01, 02, 03, 04 ... to the end of the assembly.

**TECHNICAL ASSISTANCE**

To request Technical Assistance, the consumer must contact the retailer from whom you purchased this product and request technical assistance for the damaged parts. The warranty covers all parts, parts and components that may eventually present a manufacturing defect within a period of 03 (three) months, counting from the delivery of the product to the consumer, by means of a purchase invoice. If there is any change in the structure of the product or defect occurs due to negligence of the assembler/consumer in relation to the assembly and handling instruction, free technical assistance will not be provided.

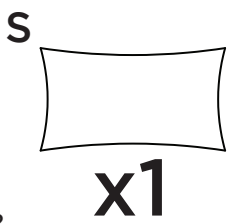
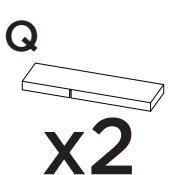
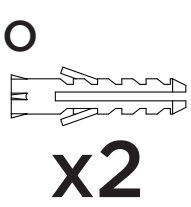
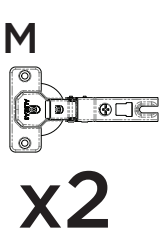
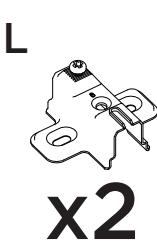
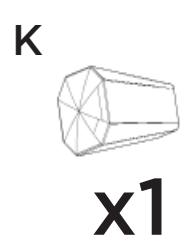
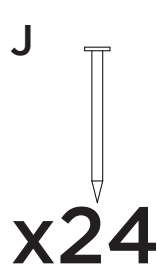
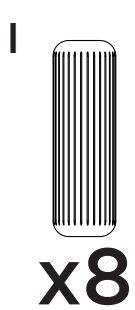
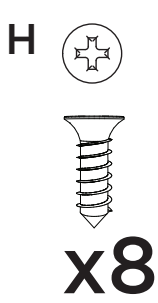
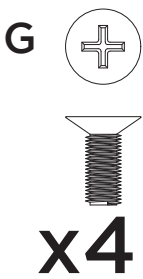
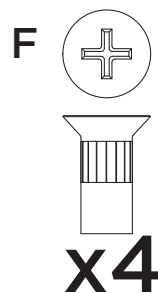
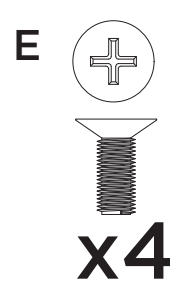
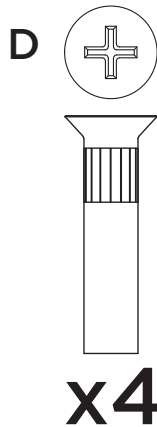
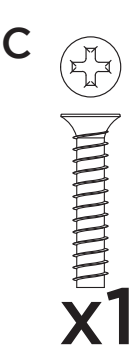
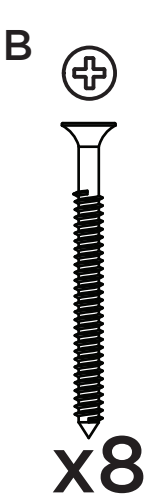
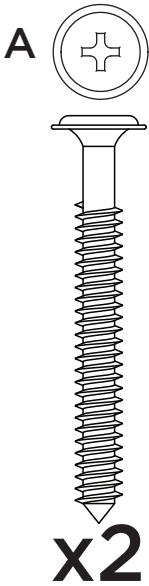

Parafusos em escala  
Tornillos escalados  
Scaled screws **1:1**

 Os parafusos (D/E) devem ser usados somente quando este módulo for acoplado a outro módulo componível Henn.

 Los tornillos (D/E) se debe utilizar sólo cuando el módulo está conectado a otro módulo componible Henn.

 Screws (D/E) are to be used only when this module is mated to another Henn buildable module.

# LISTA DE PEÇAS | LISTA DE PIEZAS | LIST OF PIECES

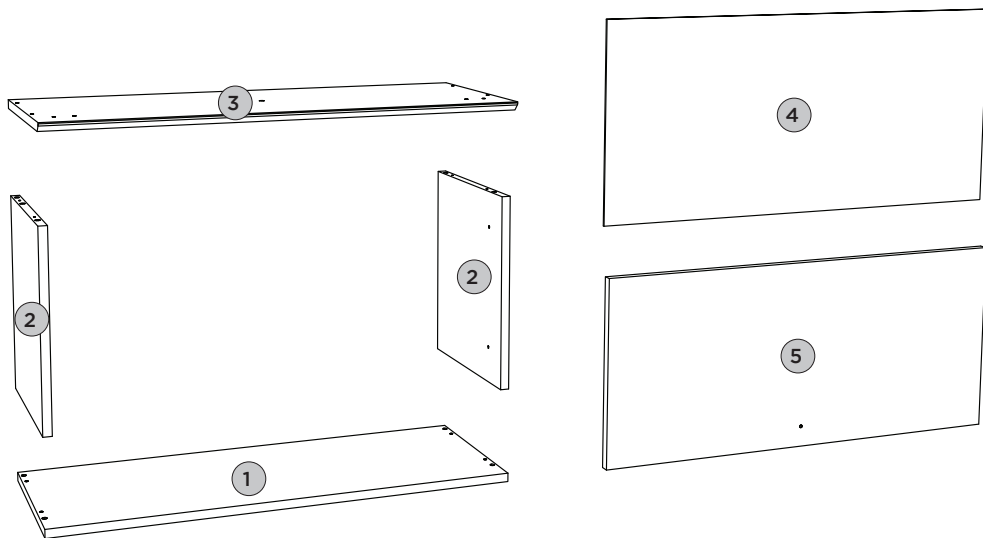





Item	Caixa Caja Box	Qtd Ctd Qty	Descrição Descripción Description	Dimensões (mm)   Dimensiones (mm)   Dimensions (mm)		
				Comprimento Largo Length	Largura Ancho Width	Espessura Grosor Thickness
1	1/1	01	BASE   BASE   BASE	800	295	15
2	1/1	02	LATERAL DIREITA ESQUERDA   LATERAL DERECHA IZQUIERDA   RIGHT LEFT SIDE	337	295	15
3	1/1	01	TAMPO   TAPA   TOP	800	322	15
4	1/1	01	FUNDO   FONDO   BACKGROUND	793	361	3
5	1/1	01	PORTA BASCULANTE   PUERTA BASCULANTE   BASCULATING DOOR	796	345	15

**PASSO 1****PEÇAS REQUERIDAS**

2	LATERAL DIREITA ESQUERDA	x2
3	TAMPO	x1

**ACESSÓRIOS REQUERIDOS**

F		04
G		04
I		08
L		02
S		

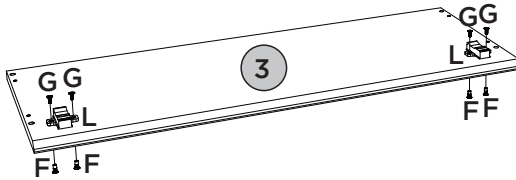
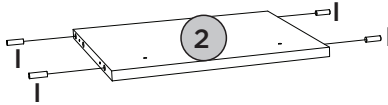
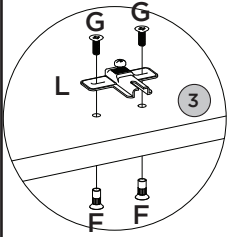
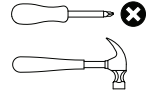
**FERRAMENTAS NECESSÁRIAS**

Utilizar o sachê de cola (S) em todas as cavilhas (I) do produto.



Con el pegamento sobre (S) en todos los pernos (I) producto.

Use the glue sachet (S) on all the pegs (I) of the product.

**PASSO 2****PEÇAS REQUERIDAS**

1	BASE	x1
2	LATERAL DIREITA ESQUERDA	x2
3	TAMPO	x1

**ACESSÓRIOS REQUERIDOS**

B		08
S		

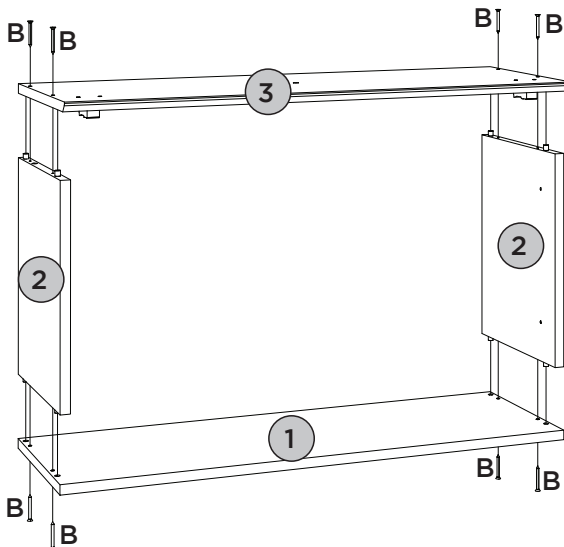
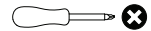
**FERRAMENTAS NECESSÁRIAS**



# PASSO 3

ITM/C633-

## PEÇAS REQUERIDAS

4	FUNDO	x1
---	-------	----

## ACESSÓRIOS REQUERIDOS

J		24
---	---	----

## FERRAMENTAS NECESSÁRIAS

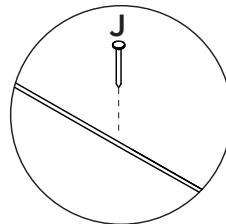
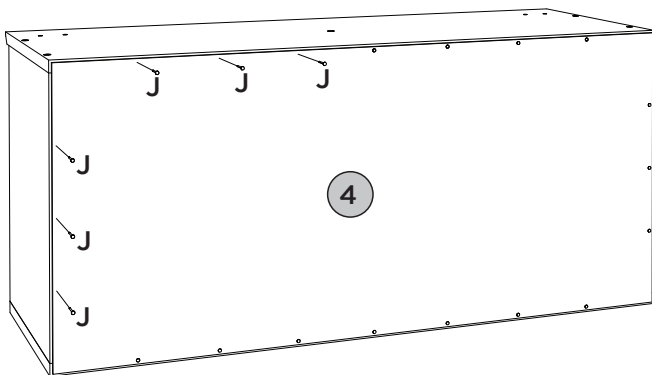
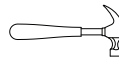

Fixar os pregos a uma distância de 100mm de um para outro.

Fijar las uñas a un distancia de 100mm uno a otro.







Fix the nails at a distance of 100mm from one to the other

# PASSO 4

## PEÇAS REQUERIDAS

5	PORTA BASCULANTE	x1
---	------------------	----

## ACESSÓRIOS REQUERIDOS

C	 	01
H	 	04
K		01
M		02

## FERRAMENTAS NECESSÁRIAS

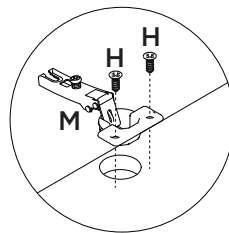
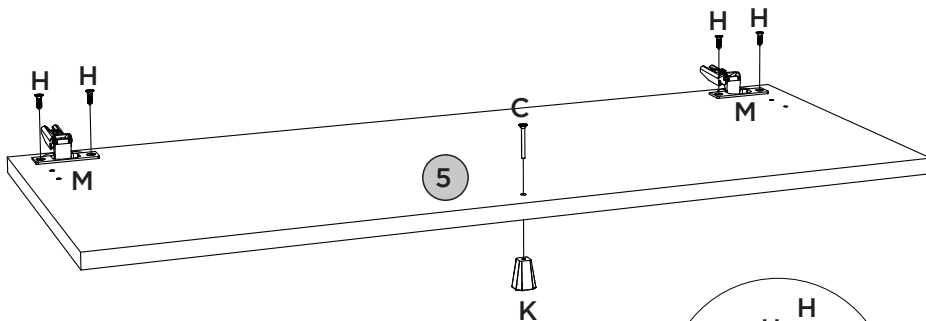
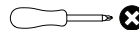

## PEÇAS REQUERIDAS

5	PORTA BASCULANTE	x1
---	------------------	----

## ACESSÓRIOS REQUERIDOS

N		01
---	--	----

## FERRAMENTAS NECESSÁRIAS

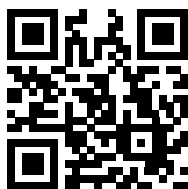
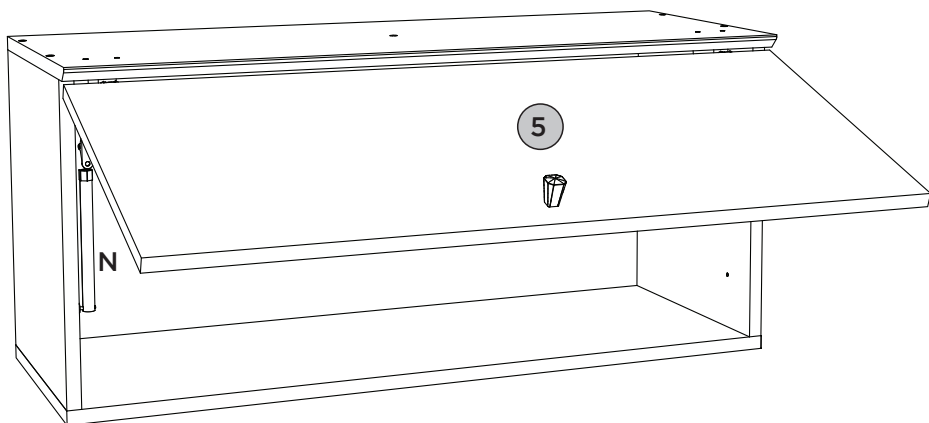
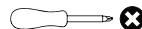

Vídeo: Dicas para instalar o Kit Pistão à Gás

Vídeo: Consejos para instalar el kit de pistón de gas

Vídeo: Tips for installing the Gas Piston Kit

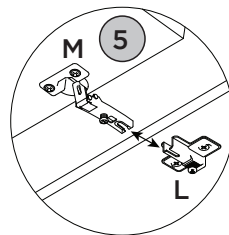
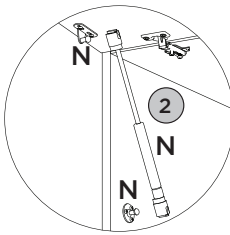
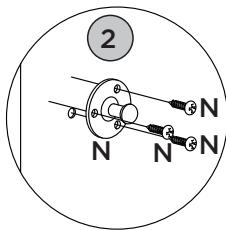
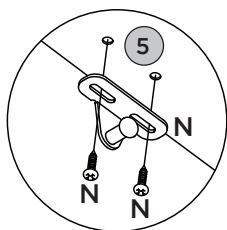

ACESSÓRIOS REQUERIDOS

A		02
H		04
O		02
P		02
Q		02
R		10

FERRAMENTAS NECESSÁRIAS



OU

Para parede: Ajustar no modo perfuração  
Para peça (O2): Usar torque 5

Pesos máximos recomendados com carga distribuída  
Peso máximo recomendado con la carga distribuida  
Recommended maximum weight with distributed load.

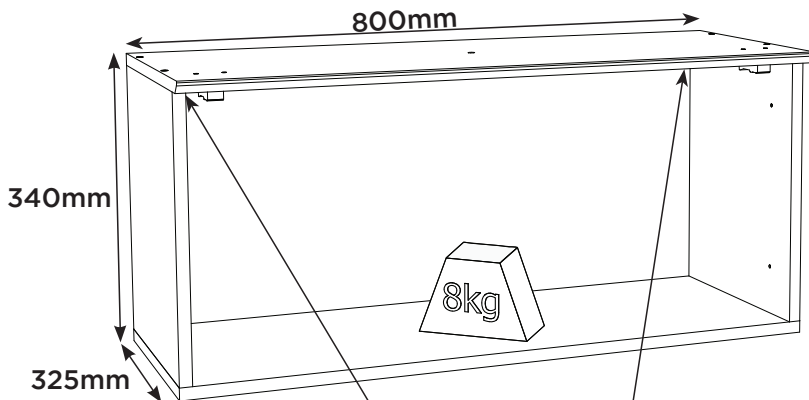

RECOMENDAÇÃO

Para fixar o móvel na parede usar o suporte de fixação (P), o parafuso 4,0x14mm CHT (H), a Bucha 8mm (O) e o parafuso 5,0x50mm FLA (A).

RECOMENDACIÓN

Para conectar el móvil a la pared con el soporte (P), tornillo 4,0 x14mm CHT (H), el casquillo de 8 mm (O) y el 5,0 x50mm tornillo FLA (A).

RECOMMENDATION

To fix the furniture to the wall use the fixing bracket (P), the 4,0x14mm CHT (H) screw, the 8mm bushing (O) and the 5,0x50mm FLA screw (A).

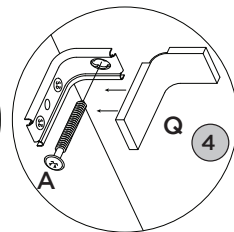
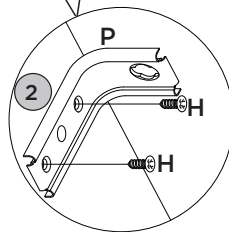
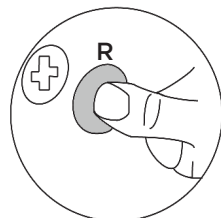

**Produto Concluído**  
**Producto terminado**  
**Finished Product**

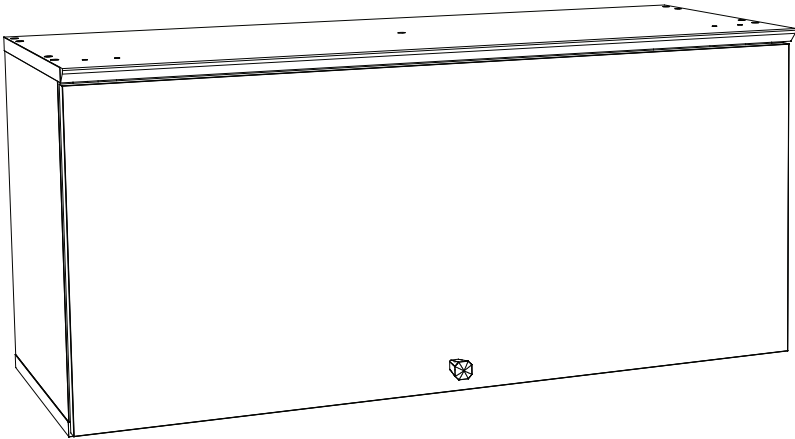

**HENN**Ind. e Com. de Móveis Henn  
Mondai - SC - Brasil

☎ +55 49 3674.3500

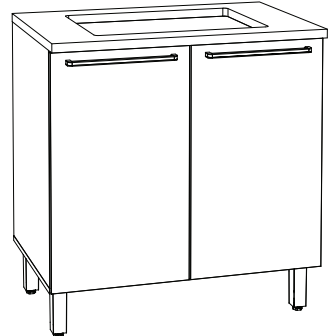
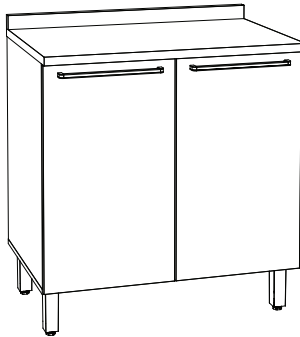
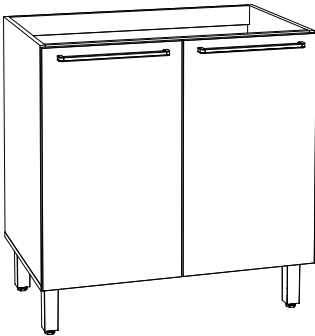
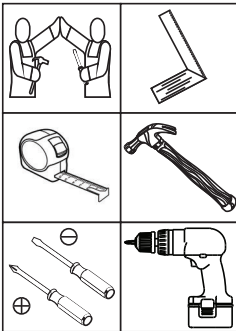
📧 @moveishenn  
www.henn.com.br**INSTRUÇÕES DE  
MONTAGEM**INSTRUCCIONES DE MONTAJE  
ASSEMBLY INSTRUCTIONS**Balcão 02 Portas 800mm Requite |****Contador 02 Puertas 800mm Requite | Counter 02 Doors 800mm Requite****C639-217 Nature/Areia HP****Opção 01  
Opción 01  
Option 01****Opção 02  
Opción 02  
Option 02****Requisitos para montagem  
Requisitos para la montaje  
Assembly Requirements**

Imagens meramente ilustrativas,  
não acompanha o produto.  
Imágenes ilustrativas, no incluidas  
con el producto.  
Illustrative images, not included  
with the product.

**AVISO**

Para limpeza de seu móvel, use uma franela seca ou umedecida, e não utilize produtos químicos que possam danificar seu produto.

**SISTEMA DE MONTAGEM**

O sistema de montagem dos produtos, funciona de acordo com a ordem crescente dos números indicados no desenho. Ex: 01, 02, 03, 04... até a conclusão da montagem.

**ASSISTÊNCIA TÉCNICA**

Para solicitação de Assistência Técnica você consumidor deverá entrar em contato com o Lojista a qual você realizou a compra deste produto e solicitar a assistência técnica das peças avariadas. A garantia abrange todas as peças, partes e componentes que eventualmente venham apresentar defeito de fabricação no prazo de 03 (três) meses, contando a partir da entrega do produto ao consumidor, mediante nota fiscal de compra. Se houver qualquer alteração na estrutura do produto ou ocorrer defeito por negligência do montador/consumidor em relação a instrução de montagem e manuseio, não será fornecido assistência técnica gratuita.

**ADVERTENCIA**

Para limpieza de su móvil, use una franela seca o húmeda, y no utilice productos químicos que puedan dañar su producto.

**SISTEMA DE MONTAJE**

El sistema de montaje de los productos funciona de acuerdo con el orden creciente de los números indicados en el dibujo. Ej.: 01, 02, 03, 04... hasta la conclusión del montaje.

**ASSISTÊNCIA TÉCNICA**

Para solicitar Asistencia Técnica, el consumidor debe comunicarse con el Comercio que usted realizó la compra de este producto y solicita asistencia técnica para las partes dañadas. La garantía cubre todas las partes, piezas y componentes que eventualmente puedan presentar defecto de fabricación en el plazo de 03 (tres) meses, contados a partir de la entrega del producto al consumidor, mediante factura de compra. Si se produce algún cambio en la estructura del producto o se produce un defecto por negligencia del montador/consumidor en relación con las instrucciones de montaje y manipulación, no se prestatá asistencia técnica gratuita.

**NOTICE**

To clean your furniture, use a dry or wet cloth, and do not use chemicals that may damage your product.

**ASSEMBLY SYSTEM**

The products' assembly system works according to the increasing order of the indicated numbers. For example: 01, 02, 03, 04 ... to the end of the assembly.

**TECHNICAL ASSISTANCE**

To request Technical Assistance, the consumer must contact the retailer from whom you purchased this product and request technical assistance for the damaged parts. The warranty covers all parts, parts and components that may eventually present a manufacturing defect within a period of 03 (three) months, counting from the delivery of the product to the consumer, by means of a purchase invoice. If there is any change in the structure of the product or defect occurs due to negligence of the assembler/consumer in relation to the assembly and handling instruction, free technical assistance will not be provided.

# ACESSÓRIOS | ACCESORIOS | ACCESSORIES

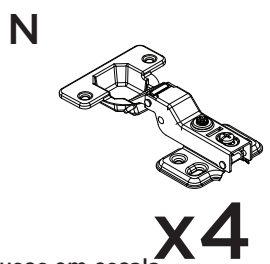
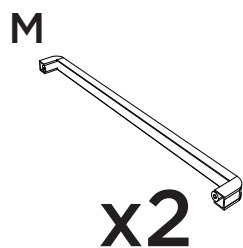
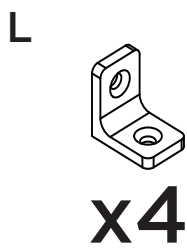
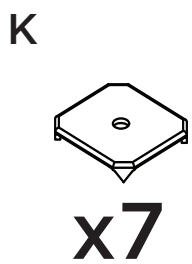
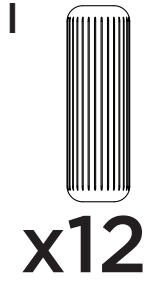
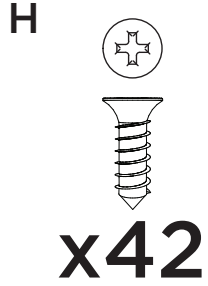
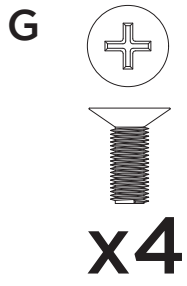
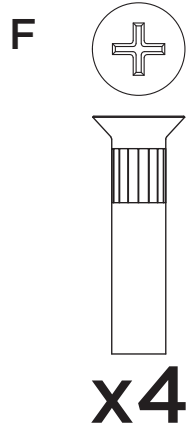
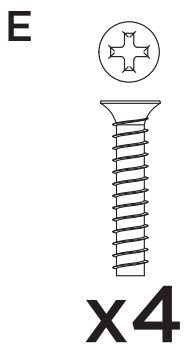
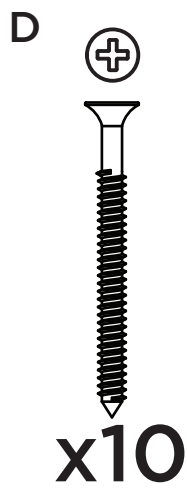
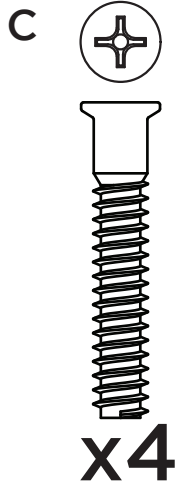
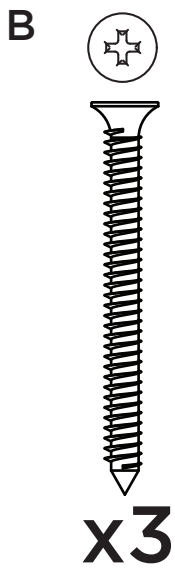
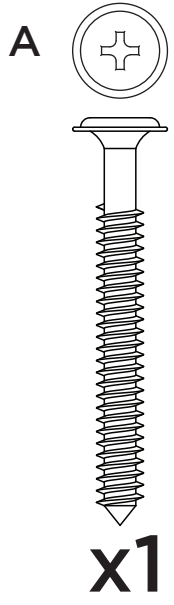

Parafusos em escala  
Tornillos escalados  
Scaled screws **1:1**

# ACESSÓRIOS | ACCESORIOS | ACCESSORIES

O

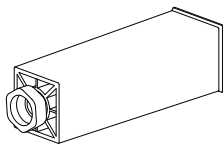

x4

P

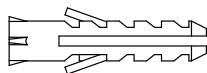

x1

Q

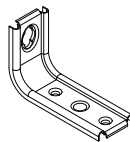

x1

R

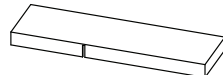

x1

S

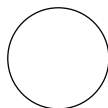

x14

T

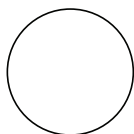

x4

U

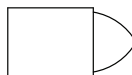

x3

V

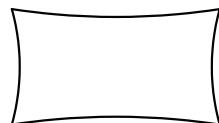

x1



Os parafusos (F/G) devem ser usados somente quando este módulo for acoplado a outro módulo componível Henn.



Los tornillos (F/G) se debe utilizar sólo cuando el módulo está conectado a otro módulo componible Henn.



Screws (F/G) are to be used only when this module is mated to another Henn buildable module.

## LISTA DE PEÇAS | LISTA DE PIEZAS | LIST OF PIECES

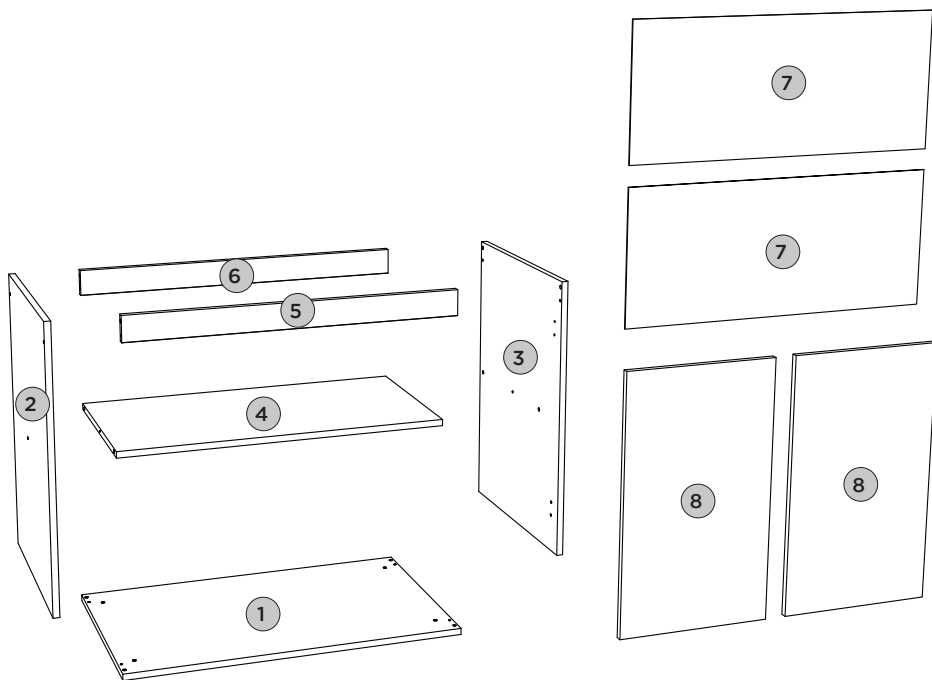

Item	Caixa Caja Box	Qtd Ctd Qty	Descrição Descripción Description	Dimensões (mm)   Dimensiones (mm)   Dimensions (mm)		
				Comprimento Largo Length	Largura Ancho Width	Espessura Grosor Thickness
1	1/1	01	BASE   BASE   BASE	800	490	15
2	1/1	01	LATERAL ESQUERDA   LATERAL IZQUIERDA   LEFT SIDE	660	490	15
3	1/1	01	LATERAL DIREITA   LATERAL DERECHA   RIGHT SIDE	660	490	15
4	1/1	01	PRATELEIRA   ESTANTE   SHELF	768	400	15
5	1/1	01	TRAVESSA FRONTAL   TRAVESAÑO FRONTAL   FRONT CROSSBAR	768	60	15
6	1/1	01	TRAVESSA TRASEIRA   TRAVESAÑO TRASERO   REAR BUMPER	768	60	15
7	1/1	02	FUNDO   FONDO   BOTTOM	792	335	3
8	1/1	02	PORTA   PUERTA   DOOR	665	396	15







# PASSO 1

ITM/C639-

## PEÇAS REQUERIDAS

1	BASE	x1
2	LATERAL ESQUERDA	x1
3	LATERAL DIREITA	x1
4	PRATELEIRA	x1
5	TRAVESSA FRONTAL	x1
6	TRAVESSA TRASEIRA	x1

## ACESSÓRIOS REQUERIDOS

C		04
I		12
O		04
V		

## FERRAMENTAS NECESSÁRIAS

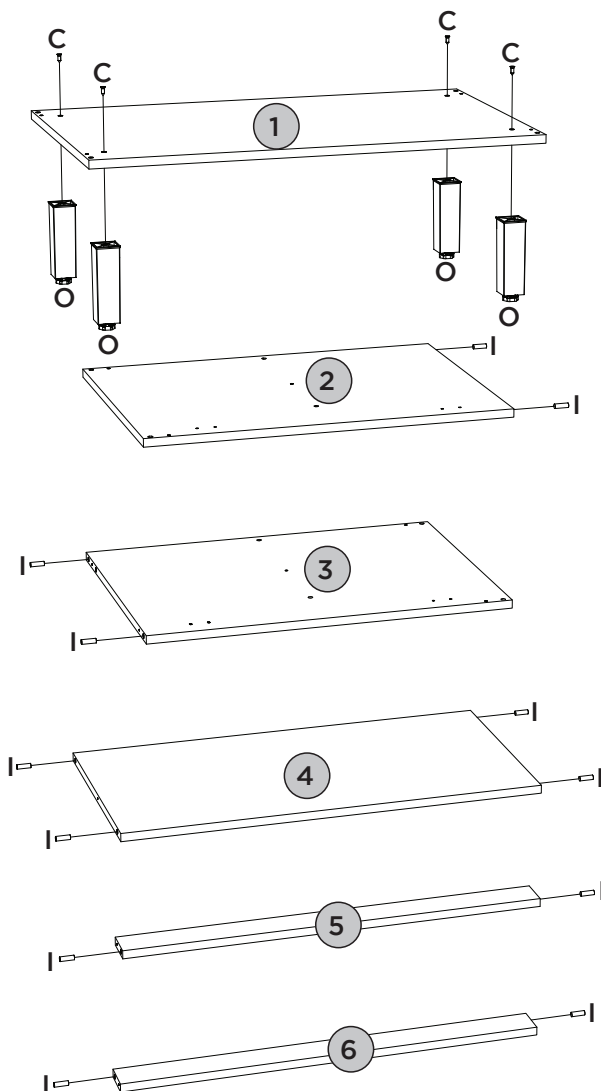
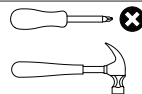

Utilizar o sachê de cola (V) em todas as cavilhas (I) do produto.



Con el pegamento sobre (V) en todos los pernos (I) producto.

Use the glue sachet (V) on all the pegs (I) of the product.

**PASSO 2****PEÇAS REQUERIDAS**



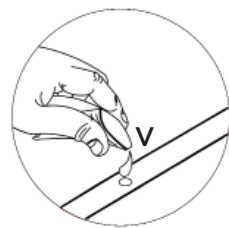
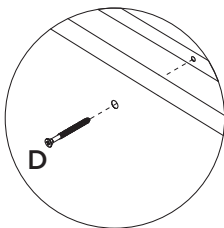
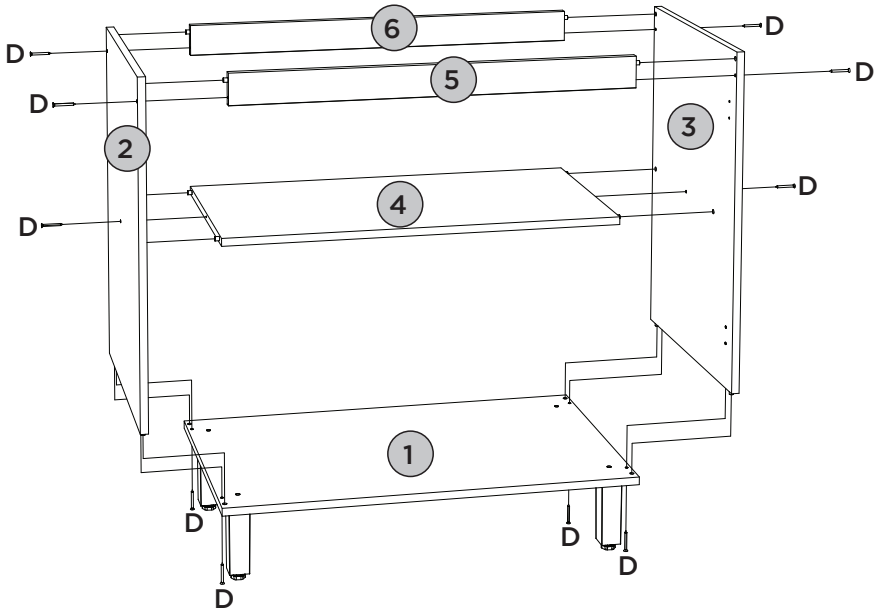

1	BASE	x1
2	LATERAL ESQUERDA	x1
3	LATERAL DIREITA	x1
4	PRATELEIRA	x1
5	TRAVESSA FRONTAL	x1
6	TRAVESSA TRASEIRA	x1

**ACESSÓRIOS REQUERIDOS**

D		10
V		

**FERRAMENTAS NECESSÁRIAS**

ACESSÓRIOS REQUERIDOS

B			03
H			08
L			04

FERRAMENTAS NECESSÁRIAS

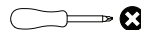

Esse tampo é opcional e é vendido separadamente (C904-128).

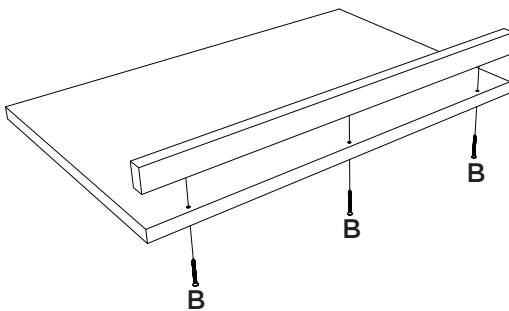



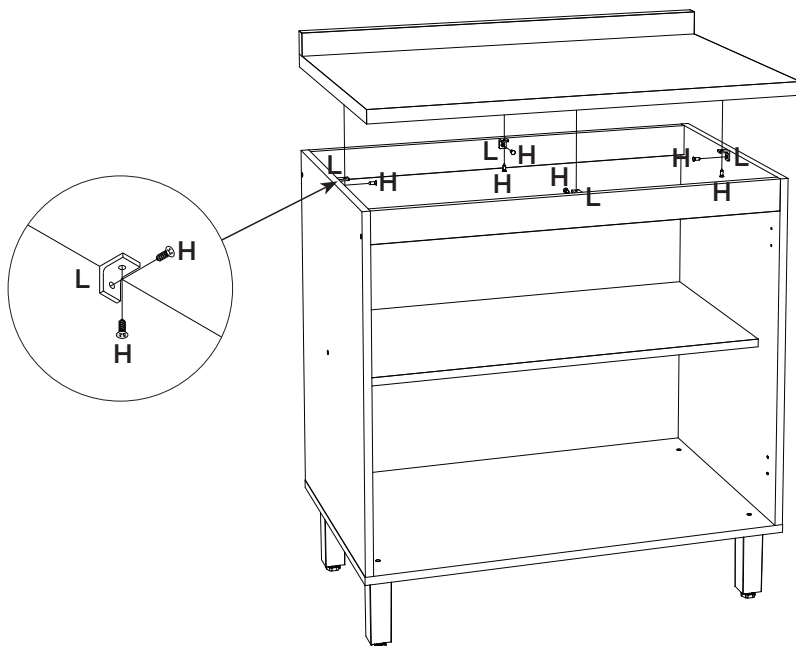

Esta vez es opcional y se vende por separado (C904-128).

This top is optional and is sold separately (C904-128).



### ACESSÓRIOS REQUERIDOS

H			08
L			04

### FERRAMENTAS NECESSÁRIAS

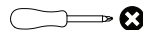

Esse tampo é opcional e é vendido separadamente (C908-128).

Esta vez es opcional y se vende por separado (C908-128).

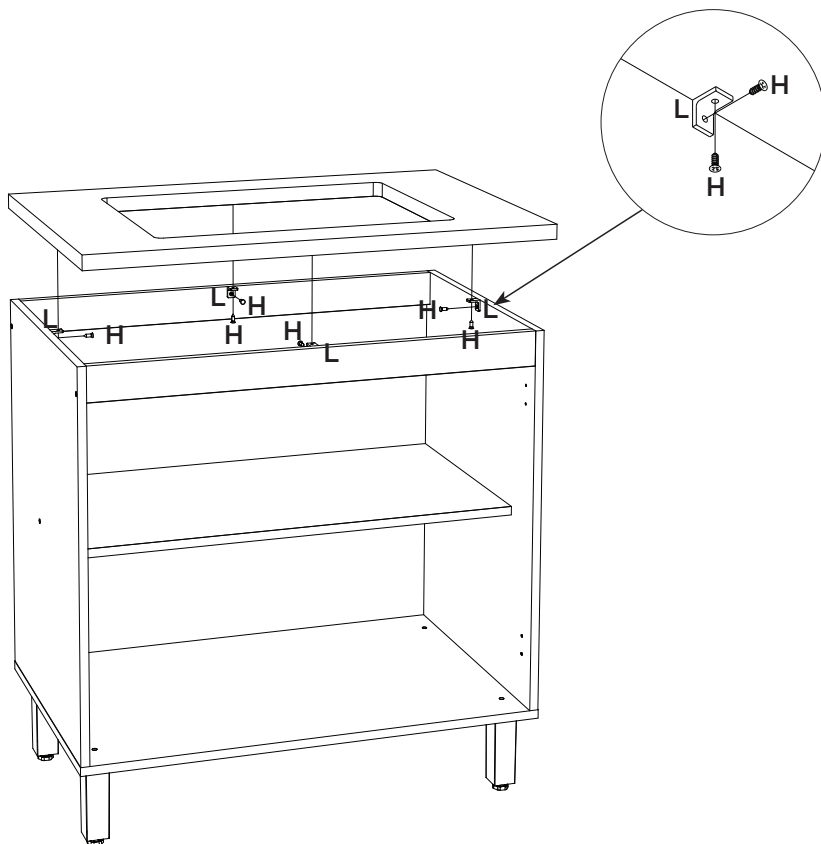

This top is optional and is sold separately (C908-128).



## PEÇAS REQUERIDAS

7	FUNDO	x2
---	-------	----

## ACESSÓRIOS REQUERIDOS

H		08
J		27
K		07

## FERRAMENTAS NECESSÁRIAS

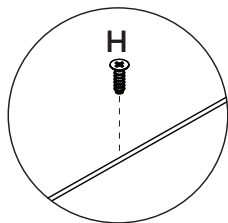
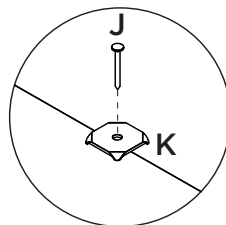
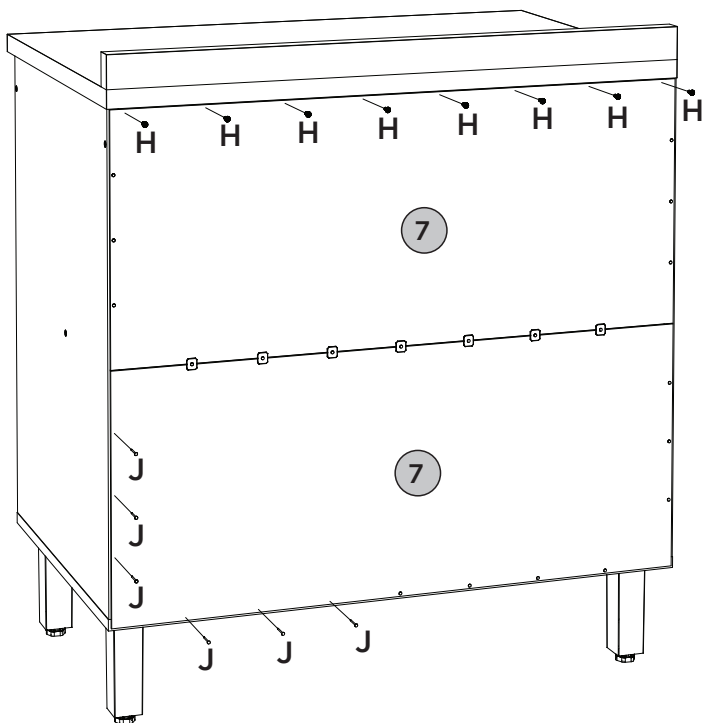
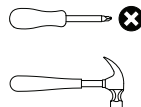

Fixar os pregos a uma distância de 100mm de um para outro.



Fijar las uñas a un distancia de 100mm uno a otro.

Fix the nails at a distance of 100mm from one to the other

**PASSO 6****PEÇAS REQUERIDAS**

8	PORTA	x2
---	-------	----

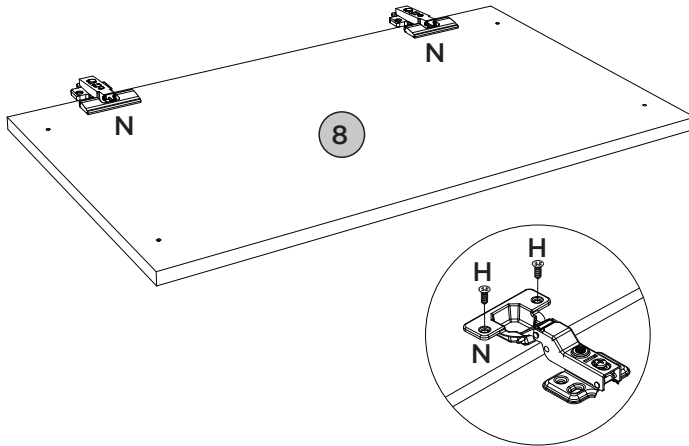
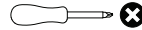

**ACESSÓRIOS REQUERIDOS**

H		08
N		04

**FERRAMENTAS NECESSÁRIAS****PASSO 7****PEÇAS REQUERIDAS**

8	PORTA	x2
---	-------	----

**ACESSÓRIOS REQUERIDOS**

E		04
H		16
M		02

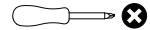
**FERRAMENTAS NECESSÁRIAS**

Para porta (8): Defina para o modo de perfuração.

Faça a furação passante para fixar o puxador (M).

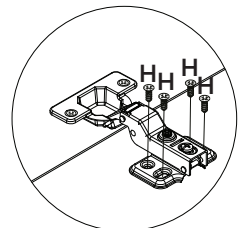
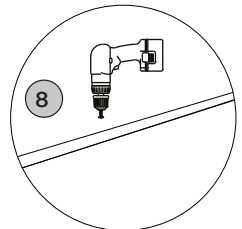
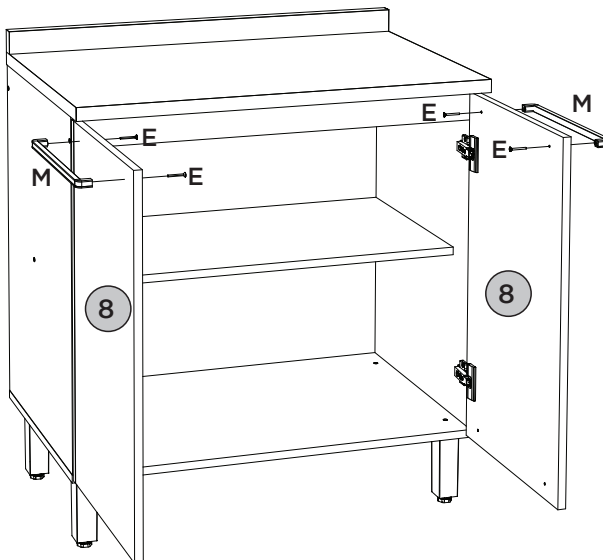

## ACESSÓRIOS REQUERIDOS

A		01	R		01
H		02	S		14
P		01	T		04
Q		01	U		03

## FERRAMENTAS NECESSÁRIAS

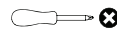

OU



Para parede: Ajustar no modo perfuração

**Pesos máximos recomendados com carga distribuída**  
**Peso máximo recomendado con la carga distribuida**  
**Recommended maximum weight with distributed load.**

PERFECT CORRECTION  
 CORRECCIÓN PERFECTA

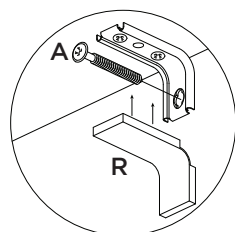
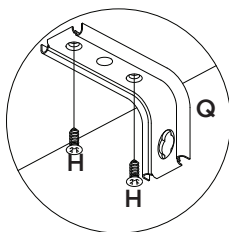
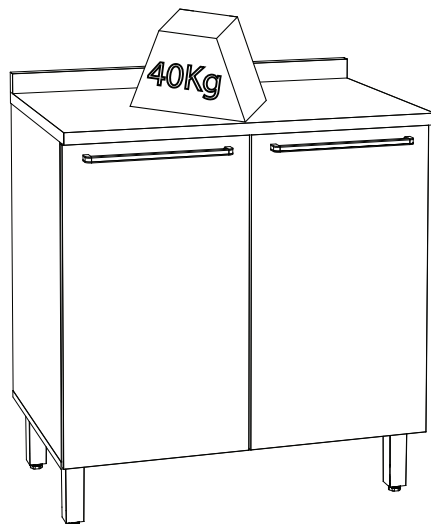
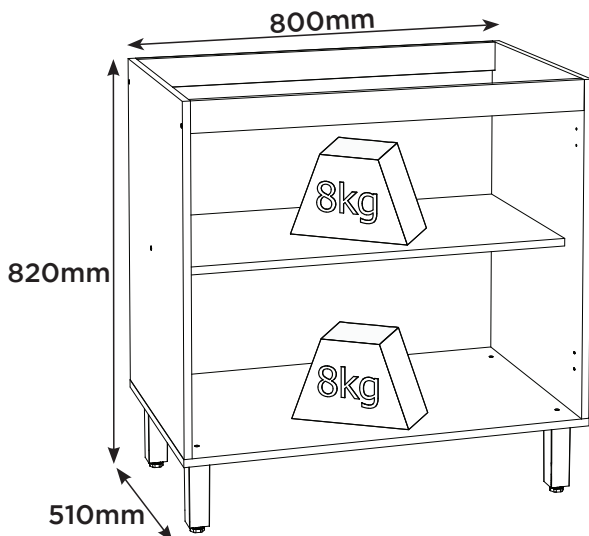
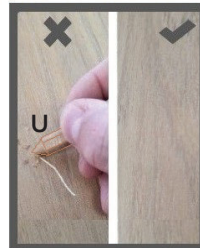

### RECOMENDAÇÃO

Para fixar o móvel na parede usar o suporte de fixação (Q), o parafuso 4,0x14mm CHT (H), a Bucha 8mm (P) e o parafuso 5,0x50mm FLA (A).

### RECOMENDACIÓN

Para conectar el móvil a la pared con el soporte (Q), tornillo 4,0x14mm CHT (H), el casquillo de 8 mm (P) y el 5,0 x50mm tornillo FLA (A).

### RECOMMENDATION

To fix the furniture to the wall use the fixing bracket (Q), the 4,0x14mm CHT (H) screw, the 8mm bushing (P) and the 5.0x50mm FLA screw (A).

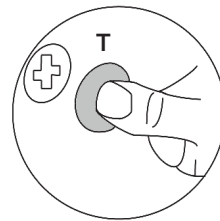
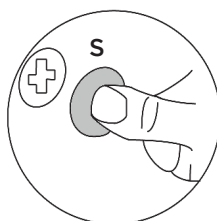

**Produto Concluído**  
**Producto terminado**  
**Finished Product**





**HENN**Ind. e Com. de Móveis Henn  
Mondai - SC - Brasil

☎ +55 49 3674.3500

📧 @moveishenn  
www.henn.com.br**INSTRUÇÕES DE MONTAGEM**INSTRUCCIONES DE MONTAJE  
ASSEMBLY INSTRUCTIONS**Tampo Cooktop 800mm | Tampo Cooktop 800mm | Cooktop top 800mm**

- C908-23 Duna
- C908-33 Nero
- C908-114 Calcare

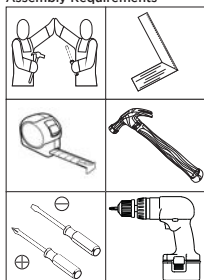
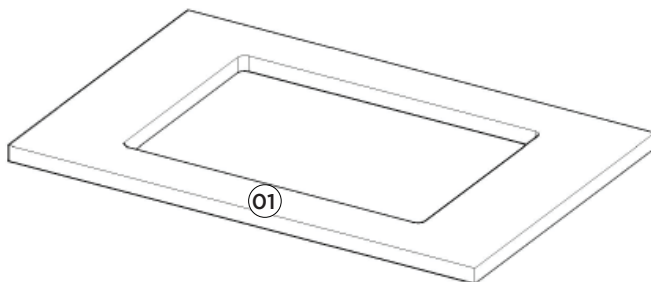
Requisitos para montagem  
Requisitor para la montaje  
Assembly RequirementsImagens meramente ilustrativas  
Imágenes meramente ilustrativas  
Images for illustration only**AVISO**

Para limpeza de seu móvel, use uma flanela seca ou umedecida, e não utilize produtos químicos que possam danificar seu produto.

**SISTEMA DE MONTAGEM**

O sistema de montagem dos produtos, funciona de acordo com a ordem crescente dos números indicados no desenho. Ex: 01, 02, 03, 04... até a conclusão da montagem.

**ADVERTENCIA**

Para limpieza de su móvil, use una franela seca o húmeda, y no utilice productos químicos que puedan dañar su producto.

**SISTEMA DE MONTAJE**

El sistema de montaje de los productos funciona de acuerdo con el orden creciente de los números indicados en el dibujo. Ej.: 01, 02, 03, 04... hasta la conclusión del montaje.

**NOTICE**

To clean your furniture, use a dry or wet cloth, and do not use chemicals that may damage your product.



**ASSEMBLY SYSTEM**

The products' assembly system works according to the increasing order of the indicated numbers. For example: 01, 02, 03, 04 ... to the end of the assembly.

**Lista de Peças | Lista de piezas | List of parts**

Item	Caixa Caja Box	Qty Ctd Qty	Descrição   Descripción   Description	Medidas (mm)   Dimensions (mm)   Size (measure- ments) (mm)
01	1/1	01	Tampo   Tapa   Top	800x533x25

**Ferragens | Herrajes | Hardware**

<b>A</b>		08x	<b>B</b>		04x
Parafuso 3,5x14mm FLA. Tornillo 3,5x14mm FLA. Screw 3,5x14mm FLA.			Cantoneira plástica Cantonera plástica Plastic angle brackets		

 Estas ferragens constam no Pacote do respectivo Balcão.  
Estos herrajes constan en el Paquete del respectivo Balcón.  
These hardware are included in the Package of the respective Counter.

Esse tampo é opcional e é vendido separadamente

Esta vez es opcional y se vende por separado

This top is optional and is sold separately

Exemplo de como fixar o Tampo Cooktop no produto.

Ejemplo de cómo fijar el Tablero Cooktop en el producto.

Example of how to secure the Cooktop Top to the product.

