

HENNInd. e Com. de Móveis Henn
Mondai - SC - Brasil

☎ +55 49 3674.3500

📧 @moveishenn
www.henn.com.br**INSTRUÇÕES DE
MONTAGEM**INSTRUCCIONES DE MONTAJE
ASSEMBLY INSTRUCTIONS**Aéreo 01 Porta Basculante 800mm Requite | Aéreo 01
Puerta Abatible 800mm Requite |
Aerial 01 Tipper Door 800mm Requite**

C633-128 Nature

C633-217 Nature/Areia HP

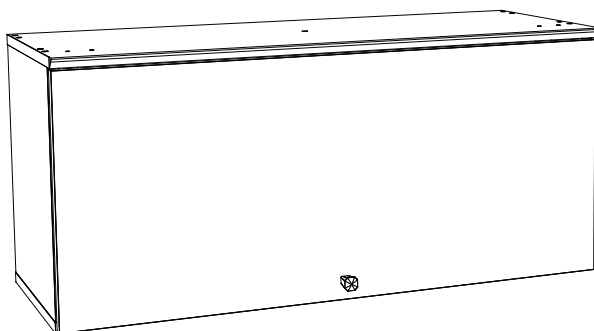
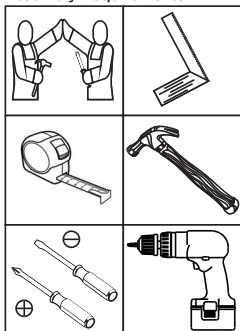
**Requisitos para montagem
Requisitos para la montaje
Assembly Requirements**

Imagens meramente ilustrativas,
não acompanha o produto.
Imágenes ilustrativas, no incluidas
con el producto.
Illustrative images, not included
with the product.

AVISO

Para limpeza de seu móvel, use uma flanela seca ou umedecida, e não utilize produtos químicos que possam danificar seu produto.

SISTEMA DE MONTAGEM

O sistema de montagem dos produtos, funciona de acordo com a ordem crescente dos números indicados no desenho. Ex: 01, 02, 03, 04... até a conclusão da montagem.

ASSISTÊNCIA TÉCNICA

Para solicitação de Assistência Técnica você consumidor deverá entrar em contato com o Lojista o qual você realizou a compra deste produto e solicitar a assistência técnica das peças avariadas. A garantia abrange todas as peças, partes e componentes que eventualmente venham apresentar defeito de fabricação no prazo de 03 (três) meses, contando a partir da entrega do produto ao consumidor, mediante nota fiscal de compra. Se houver qualquer alteração na estrutura do produto ou ocorrer defeito por negligência do montador/consumidor em relação a instrução de montagem e manuseio, não será fornecido assistência técnica gratuita.

ADVERTENCIA

Para limpeza de su móvil, use una franela seca o húmeda, y no utilice productos químicos que puedan dañar su producto.

SISTEMA DE MONTAJE

El sistema de montaje de los productos funciona de acuerdo con el orden creciente de los números indicados en el dibujo. Ej.: 01, 02, 03, 04... hasta la conclusión del montaje.

ASISTENCIA TÉCNICA

Para solicitar Asistencia Técnica, el consumidor debe comunicarse con el Comercio que usted realizó la compra de este producto y solicita asistencia técnica para las partes dañadas. La garantía cubre todas las partes, piezas y componentes que eventualmente puedan presentar defecto de fabricación en el plazo de 03 (tres) meses, contados a partir de la entrega del producto al consumidor, mediante factura de compra. Si se produce algún cambio en la estructura del producto o se produce un defecto por negligencia del montador/consumidor en relación con las instrucciones de montaje y manipulación, no se prestará asistencia técnica gratuita.

NOTICE

To clean your furniture, use a dry or wet cloth, and do not use chemicals that may damage your product.

ASSEMBLY SYSTEM

The products' assembly system works according to the increasing order of the indicated numbers. For example: 01, 02, 03, 04 ... to the end of the assembly.

TECHNICAL ASSISTANCE

To request Technical Assistance, the consumer must contact the retailer from whom you purchased this product and request technical assistance for the damaged parts. The warranty covers all parts, parts and components that may eventually present a manufacturing defect within a period of 03 (three) months, counting from the delivery of the product to the consumer, by means of a purchase invoice. If there is any change in the structure of the product or defect occurs due to negligence of the assembler/consumer in relation to the assembly and handling instruction, free technical assistance will not be provided.

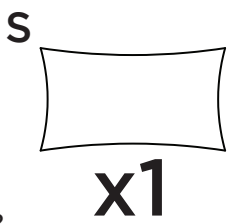
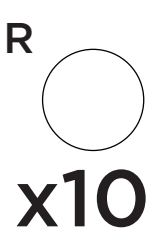
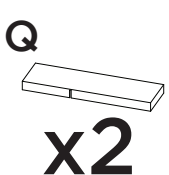
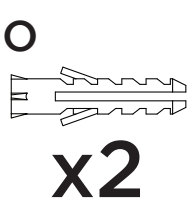
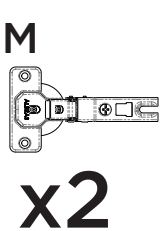
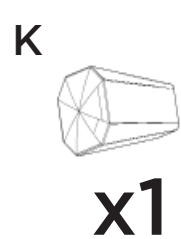
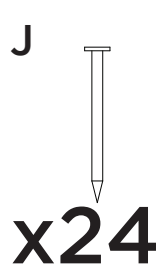
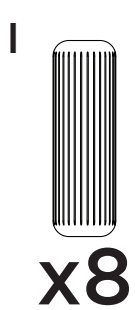
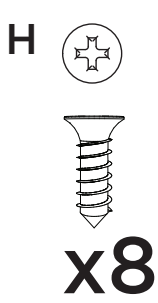
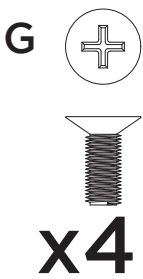
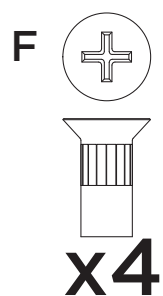
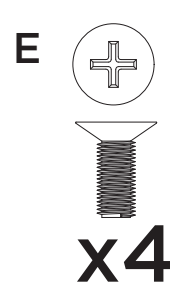
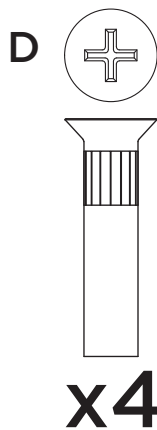
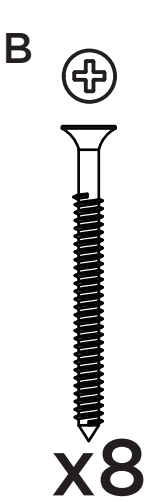
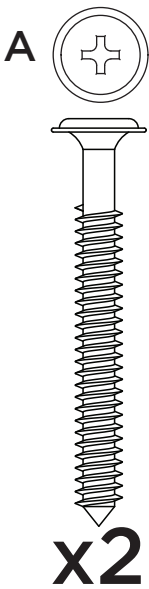

Parafusos em escala
Tornillos escalados
Scaled screws **1:1**

 Os parafusos (D/E) devem ser usados somente quando este módulo for acoplado a outro módulo componível Henn.

 Los tornillos (D/E) se debe utilizar sólo cuando el módulo está conectado a otro módulo componible Henn.

 Screws (D/E) are to be used only when this module is mated to another Henn buildable module.

LISTA DE PEÇAS | LISTA DE PIEZAS | LIST OF PIECES

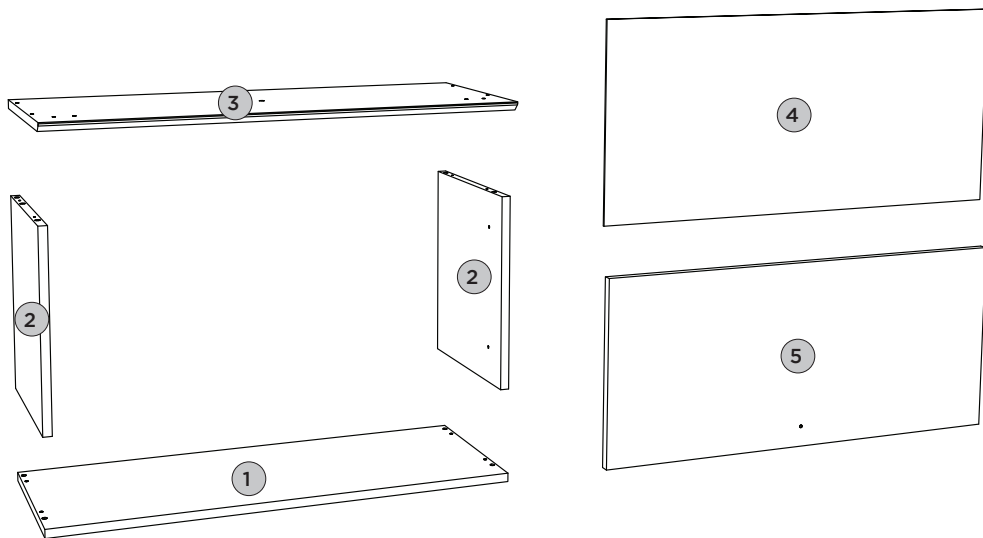





| Item | Caixa Caja Box | Qtd Ctd Qty | Descrição Descripción Description | Dimensões (mm) Dimensiones (mm) Dimensions (mm) | | |
|------|----------------------|-------------------|---------------------------------------------------------------------------|--------------------------------------------------------|---------------------------|----------------------------------|
| | | | | Comprimento Largo Length | Largura Ancho Width | Espessura Grosor Thickness |
| 1 | 1/1 | 01 | BASE BASE BASE | 800 | 295 | 15 |
| 2 | 1/1 | 02 | LATERAL DIREITA ESQUERDA LATERAL DERECHA IZQUIERDA RIGHT LEFT SIDE | 337 | 295 | 15 |
| 3 | 1/1 | 01 | TAMPO TAPA TOP | 800 | 322 | 15 |
| 4 | 1/1 | 01 | FUNDO FONDO BACKGROUND | 793 | 361 | 3 |
| 5 | 1/1 | 01 | PORTA BASCULANTE PUERTA BASCULANTE BASCULATING DOOR | 796 | 345 | 15 |

PASSO 1**PEÇAS REQUERIDAS**

| | | |
|---|--------------------------|----|
| 2 | LATERAL DIREITA ESQUERDA | x2 |
| 3 | TAMPO | x1 |

ACESSÓRIOS REQUERIDOS

| | | |
|---|-----------------------------------------------------------------------------------|----|
| F |  | 04 |
| G |  | 04 |
| I |  | 08 |
| L |  | 02 |
| S |  | |

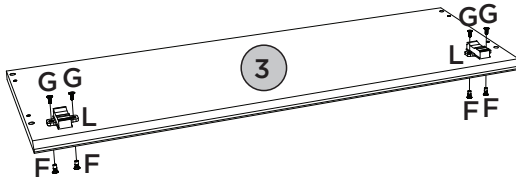
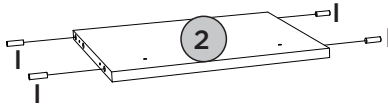
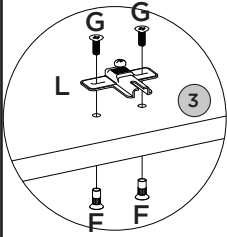
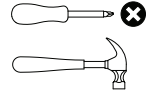
FERRAMENTAS NECESSÁRIAS

Utilizar o sachê de cola (S) em todas as cavilhas (I) do produto.



Con el pegamento sobre (S) en todos los pernos (I) producto.

Use the glue sachet (S) on all the pegs (I) of the product.

PASSO 2**PEÇAS REQUERIDAS**

| | | |
|---|--------------------------|----|
| 1 | BASE | x1 |
| 2 | LATERAL DIREITA ESQUERDA | x2 |
| 3 | TAMPO | x1 |

ACESSÓRIOS REQUERIDOS

| | | |
|---|-----------------------------------------------------------------------------------|----|
| B |  | 08 |
| S |  | |

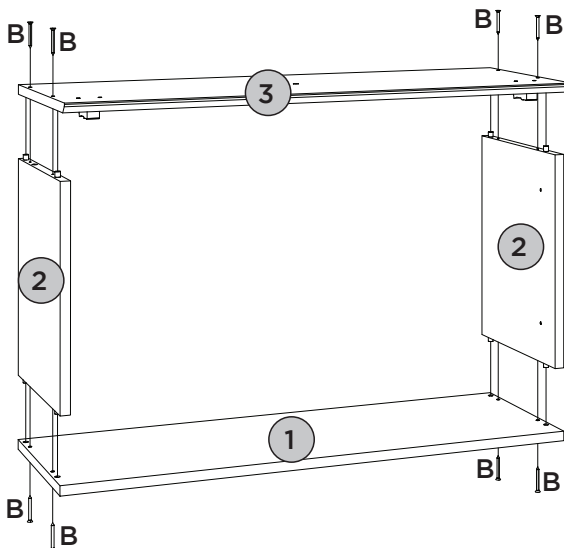
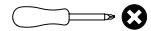
FERRAMENTAS NECESSÁRIAS

PASSO 3

ITM/C633-

PEÇAS REQUERIDAS

| | | |
|---|-------|----|
| 4 | FUNDO | x1 |
|---|-------|----|

ACESSÓRIOS REQUERIDOS

| | | |
|---|-----------------------------------------------------------------------------------|----|
| J |  | 24 |
|---|-----------------------------------------------------------------------------------|----|

FERRAMENTAS NECESSÁRIAS

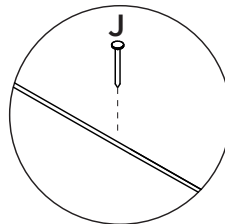
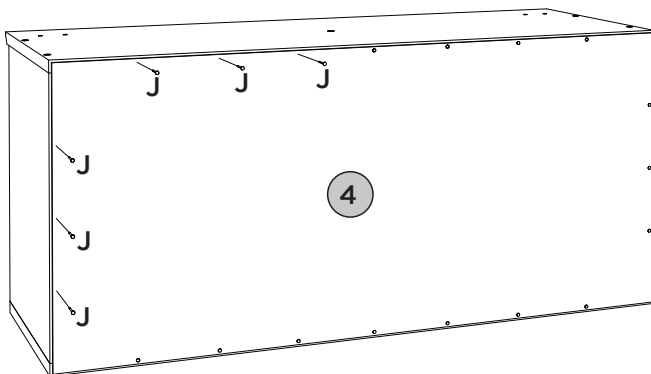
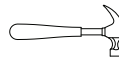

Fixar os pregos a uma distância de 100mm de um para outro.

Fijar las uñas a un distancia de 100mm uno a otro.







Fix the nails at a distance of 100mm from one to the other

PASSO 4

PEÇAS REQUERIDAS

| | | |
|---|------------------|----|
| 5 | PORTA BASCULANTE | x1 |
|---|------------------|----|

ACESSÓRIOS REQUERIDOS

| | | | |
|---|-----------------------------------------------------------------------------------|-----------------------------------------------------------------------------------|----|
| C |  |  | 01 |
| H |  |  | 04 |
| K |  | | 01 |
| M |  | | 02 |

FERRAMENTAS NECESSÁRIAS

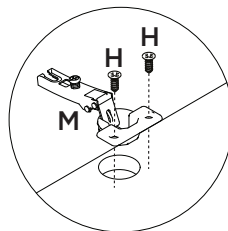
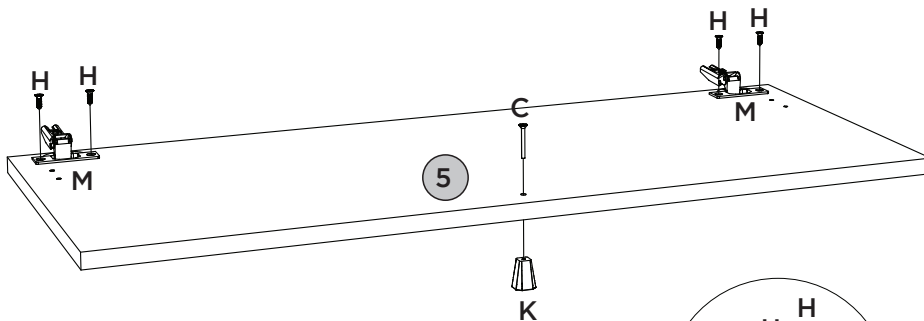
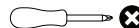

PEÇAS REQUERIDAS

| | | |
|---|------------------|----|
| 5 | PORTA BASCULANTE | x1 |
|---|------------------|----|

ACESSÓRIOS REQUERIDOS

| | | |
|---|--|----|
| N | | 01 |
|---|--|----|

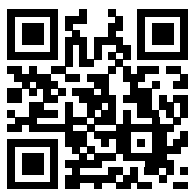
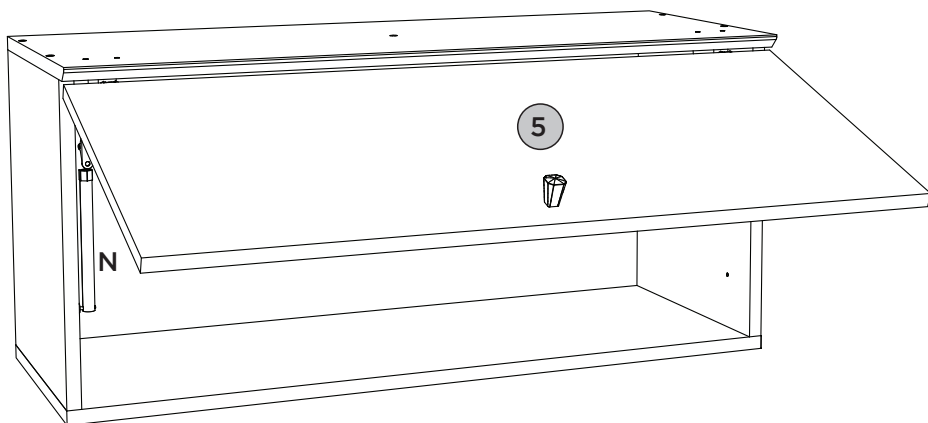
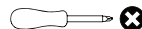
FERRAMENTAS NECESSÁRIAS

Vídeo: Dicas para instalar o Kit Pistão à Gás

Vídeo: Consejos para instalar el kit de pistón de gas

Vídeo: Tips for installing the Gas Piston Kit

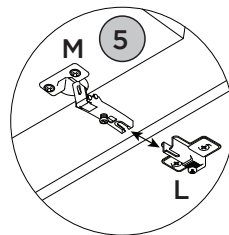
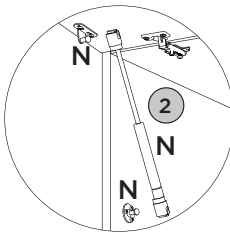
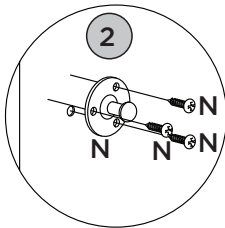
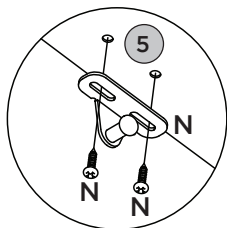

ACESSÓRIOS REQUERIDOS

| | | |
|---|--|----|
| A | | 02 |
| H | | 04 |
| O | | 02 |
| P | | 02 |
| Q | | 02 |
| R | | 10 |

FERRAMENTAS NECESSÁRIAS



OU

Para parede: Ajustar no modo perfuração
Para peça (O2): Usar torque 5

Pesos máximos recomendados com carga distribuída
Peso máximo recomendado con la carga distribuida
Recommended maximum weight with distributed load.

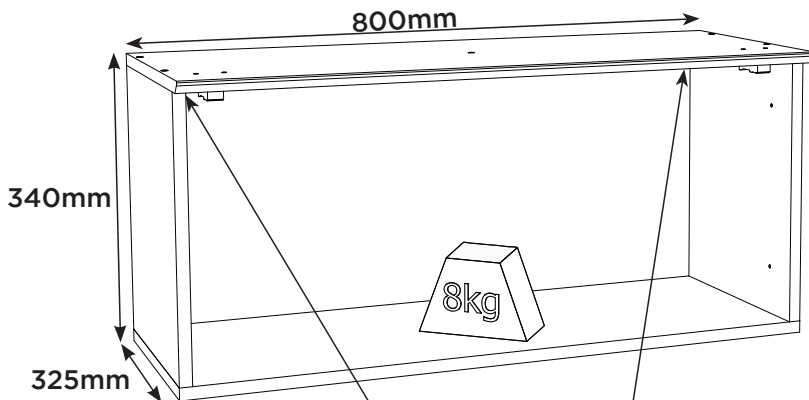

RECOMENDAÇÃO

Para fixar o móvel na parede usar o suporte de fixação (P), o parafuso 4,0x14mm CHT (H), a Bucha 8mm (O) e o parafuso 5,0x50mm FLA (A).

RECOMENDACIÓN

Para conectar el móvil a la pared con el soporte (P), tornillo 4,0 x14mm CHT (H), el casquillo de 8 mm (O) y el 5,0 x50mm tornillo FLA (A).

RECOMMENDATION

To fix the furniture to the wall use the fixing bracket (P), the 4,0x14mm CHT (H) screw, the 8mm bushing (O) and the 5,0x50mm FLA screw (A).

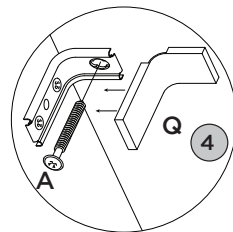
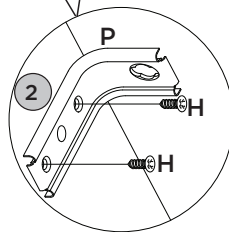
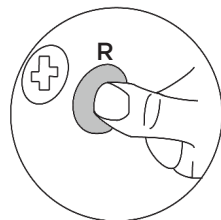

Produto Concluído
Producto terminado
Finished Product

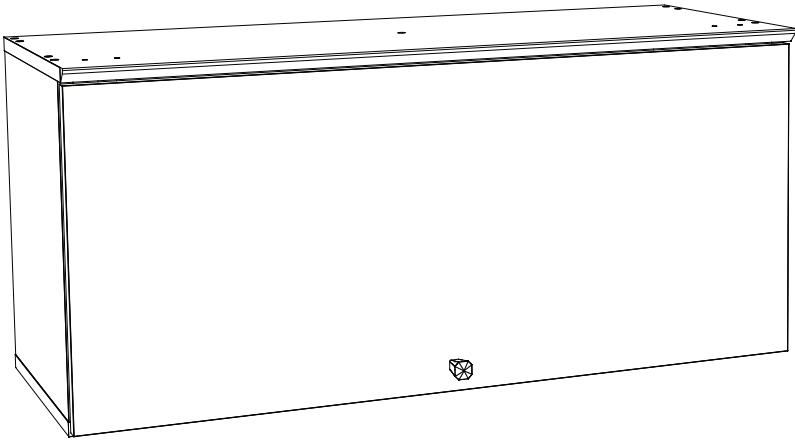

HENN

Ind. e Com. de Móveis Henn
Mondai - SC - Brasil

+55 49 3674.3500

@moveishenn
www.henn.com.br

INSTRUÇÕES DE MONTAGEM

INSTRUCCIONES DE MONTAJE
ASSEMBLY INSTRUCTIONS

Aereo 03 Portas 1200mm Requite |
Aire 03 Puertas 1200mm Requite | Air 03 Doors 1200mm Requite

C636-128 Nature
C636-217 Nature/Areia

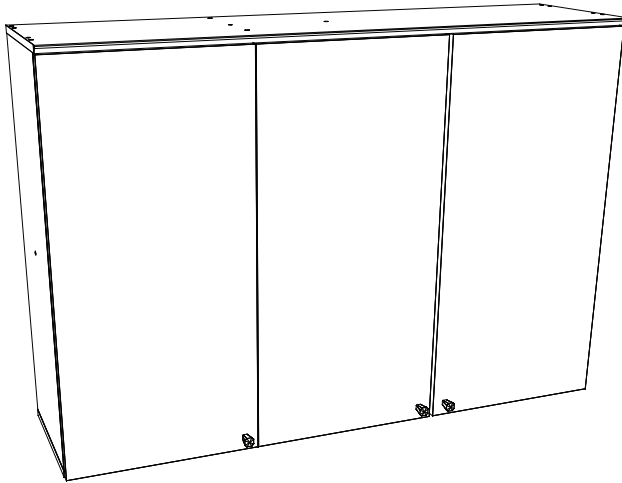

Requisitos para montagem
Requisitos para la montaje
Assembly Requirements

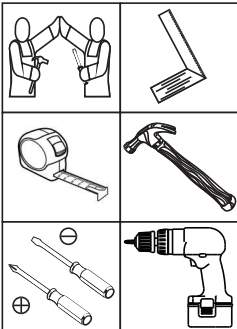

Imagens meramente ilustrativas,
não acompanha o produto.
Imágenes ilustrativas, no incluidas
con el producto.
Illustrative images, not included
with the product.

AVISO

Para limpeza de seu móvel, use uma franela seca ou umedecida, e não utilize produtos químicos que possam danificar seu produto.

SISTEMA DE MONTAGEM

O sistema de montagem dos produtos, funciona de acordo com a ordem crescente dos números indicados no desenho. Ex: 01, 02, 03, 04... até a conclusão da montagem.

ASSISTÊNCIA TÉCNICA

Para solicitação de Assistência Técnica você consumidor deverá entrar em contato com o Lojista o qual você realizou a compra deste produto e solicitar a assistência técnica das peças avariadas. A garantia abrange todas as peças, partes e componentes que eventualmente venham apresentar defeito de fabricação no prazo de 03 (três) meses, contando a partir da entrega do produto ao consumidor, mediante nota fiscal de compra. Se houver qualquer alteração na estrutura do produto ou ocorrer defeito por negligência do montador/consumidor em relação a instrução de montagem e manuseio, não será fornecido assistência técnica gratuita.

ADVERTENCIA

Para limpieza de su móvil, use una franela seca o húmeda, y no utilice productos químicos que puedan dañar su producto.

SISTEMA DE MONTAJE

El sistema de montaje de los productos funciona de acuerdo con el orden creciente de los números indicados en el dibujo. Ej.: 01, 02, 03, 04... hasta la conclusión del montaje.

ASISTENCIA TÉCNICA

Para solicitar Asistencia Técnica, el consumidor debe comunicarse con el Comercio que usted realizó la compra de este producto y solicita asistencia técnica para las partes dañadas. La garantía cubre todas las partes, piezas y componentes que eventualmente puedan presentar defecto de fabricación en el plazo de 03 (tres) meses, contados a partir de la entrega del producto al consumidor, mediante factura de compra. Si se produce algún cambio en la estructura del producto o se produce un defecto por negligencia del montador/consumidor en relación con las instrucciones de montaje y manipulación, no se prestará asistencia técnica gratuita.

NOTICE

To clean your furniture, use a dry or wet cloth, and do not use chemicals that may damage your product.

ASSEMBLY SYSTEM

The products' assembly system works according to the increasing order of the indicated numbers. For example: 01, 02, 03, 04 ... to the end of the assembly.

TECHNICAL ASSISTANCE

To request Technical Assistance, the consumer must contact the retailer from whom you purchased this product and request technical assistance for the damaged parts. The warranty covers all parts, parts and components that may eventually present a manufacturing defect within a period of 03 (three) months, counting from the delivery of the product to the consumer, by means of a purchase invoice. If there is any change in the structure of the product or defect occurs due to negligence of the assembler/consumer in relation to the assembly and handling instruction, free technical assistance will not be provided.

ACESSÓRIOS | ACCESORIOS | ACCESSORIES

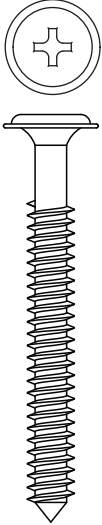
A  **x3**

B  **x16**

C  **x3**

D  **x4**

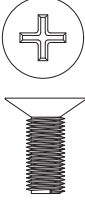
E  **x4**

F  **x42**

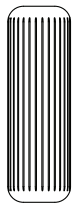
G  **x24**

H  **x66**

I  **x21**

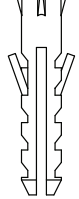
J  **x3**

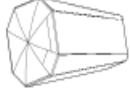
K  **x3**

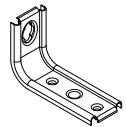
L  **x3**

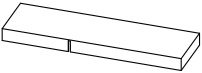
M  **x3**

N  **x18**

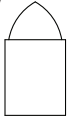
O  **x2**

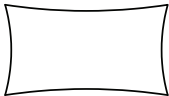
P  **x2**

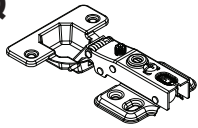
Q  **x6**

R  **x1**

 Os parafusos (D/E) devem ser usados somente quando este módulo for acoplado a outro módulo componível Henn.

 Los tornillos (D/E) se debe utilizar sólo cuando el módulo está conectado a otro módulo componible Henn.

 Screws (D/E) are to be used only when this module is mated to another Henn buildable module.

Parafusos em escala
Tornillos escalados
Scaled screws **1:1**

LISTA DE PEÇAS | LISTA DE PIEZAS | LIST OF PIECES

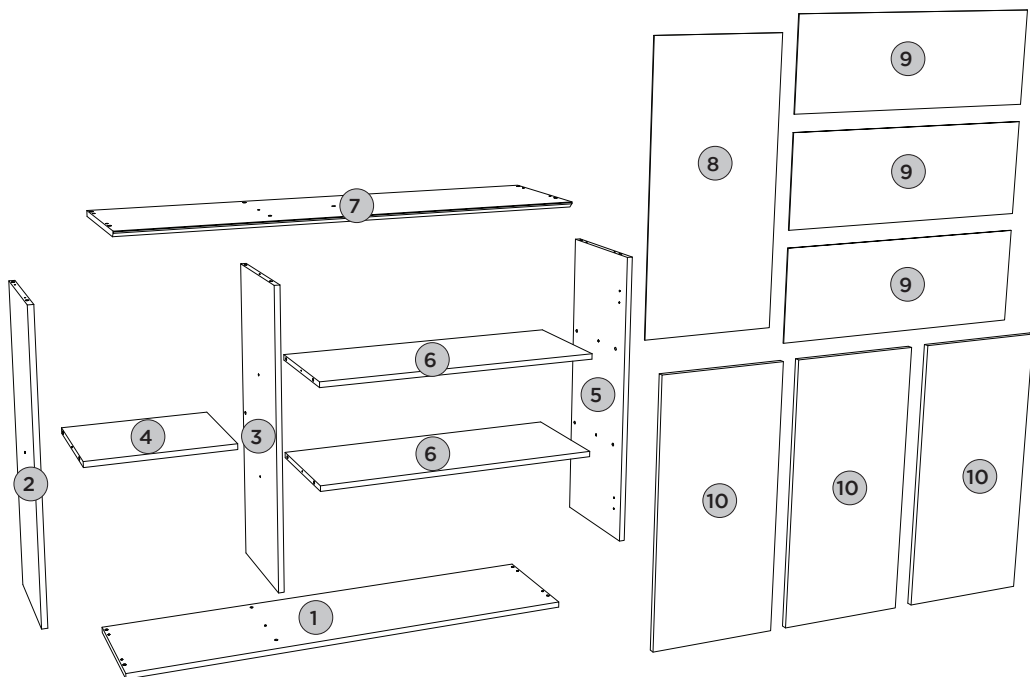

| Item | Caixa Caja Box | Qty Ctd Qty | Descrição Descripción Description | Dimensões (mm) Dimensiones (mm) Dimensions (mm) | | |
|------|----------------------|-------------------|--------------------------------------------------------|-----------------------------------------------------|---------------------------|----------------------------------|
| | | | | Comprimento Largo Length | Largura Ancho Width | Espessura Grosor Thickness |
| 1 | 1/1 | 1 | BASE BASE BASE | 1200 | 295 | 15 |
| 2 | 1/1 | 1 | LATERAL ESQUERDA LATERAL IZQUIERDA LEFT SIDE | 800 | 295 | 15 |
| 3 | 1/1 | 1 | DIVISÃO DIVISIÓN DIVISION | 800 | 295 | 15 |
| 4 | 1/1 | 1 | PRATELEIRA MENOR ESTANTE MÁS PEQUEÑO SMALLER SHELF | 382 | 295 | 15 |
| 5 | 1/1 | 1 | LATERAL DIREITA LATERAL DERECHA RIGHT SIDE | 800 | 295 | 15 |
| 6 | 1/1 | 2 | PRATELEIRA ESTANTE SHELF | 772 | 295 | 15 |
| 7 | 1/1 | 1 | TAMPO CUBRIR COVER | 1200 | 322 | 15 |
| 8 | 1/1 | 1 | FUNDO LATERAL FONDO LATERAL SIDE BACKGROUND | 824 | 401 | 3 |
| 9 | 1/1 | 3 | FUNDO FONDO BACKGROUND | 791 | 274 | 3 |
| 10 | 1/1 | 3 | PORTA PUERTA DOOR | 813 | 396 | 15 |



PASSO 1

ITM/C636-

PEÇAS REQUERIDAS

| | | |
|---|------------------|----|
| 2 | LATERAL ESQUERDA | x1 |
| 3 | DIVISÃO | x1 |
| 4 | PRATELEIRA MENOR | x1 |
| 5 | LATERAL DIREITA | x1 |
| 6 | PRATELEIRA | x2 |

ACESSÓRIOS REQUERIDOS

| | | |
|---|-----------------------------------------------------------------------------------|----|
| G |  | 24 |
| P |  | |

FERRAMENTAS NECESSÁRIAS

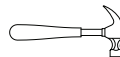

Utilizar o sachê de cola (P) em todas as cavilhas (G) do produto.

Con el pegamento sobre (P) en todos los pernos (G) producto.

Use the glue sachet (P) on all the pegs (G) of the product.

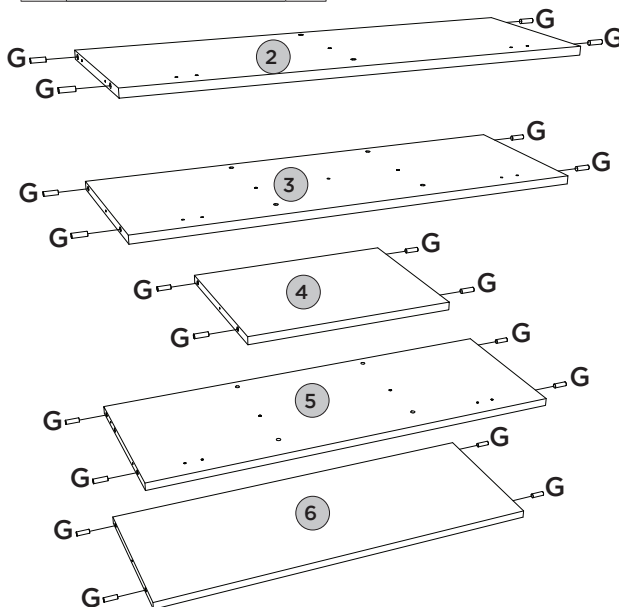



PASSO 2

PEÇAS REQUERIDAS

| | | |
|---|------------------|----|
| 1 | BASE | x1 |
| 2 | LATERAL ESQUERDA | x1 |
| 3 | DIVISÃO | x1 |
| 4 | PRATELEIRA MENOR | x1 |

ACESSÓRIOS REQUERIDOS

| | | |
|---|-----------------------------------------------------------------------------------|----|
| B |  | 05 |
| P |  | |

FERRAMENTAS NECESSÁRIAS

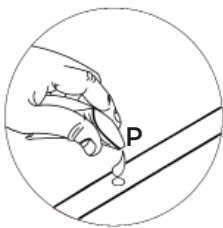
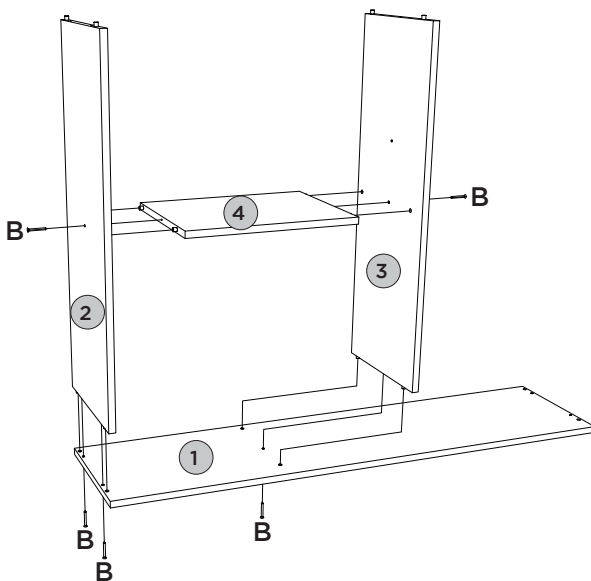
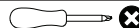





PASSO 3

ITM/C636-

PEÇAS REQUERIDAS

| | | |
|---|-----------------|----|
| 5 | LATERAL DIREITA | x1 |
| 6 | PRATELEIRA | x2 |
| 7 | TAMPO | x1 |

ACESSÓRIOS REQUERIDOS

| | | | |
|---|-----------------------------------------------------------------------------------|-----------------------------------------------------------------------------------|----|
| B |  |  | 11 |
| P |  |  | |

FERRAMENTAS NECESSÁRIAS

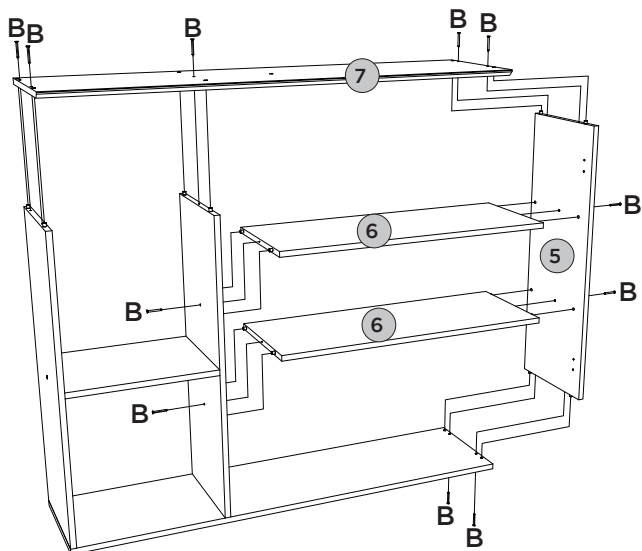
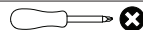



PASSO 4

PEÇAS REQUERIDAS

| | | |
|---|---------------|----|
| 8 | FUNDO LATERAL | x1 |
| 9 | FUNDO | x3 |

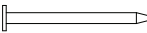
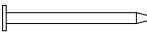
ACESSÓRIOS REQUERIDOS

| | | | |
|---|-----------------------------------------------------------------------------------|-----------------------------------------------------------------------------------|----|
| H |  |  | 66 |
| I |  |  | 21 |

FERRAMENTAS NECESSÁRIAS

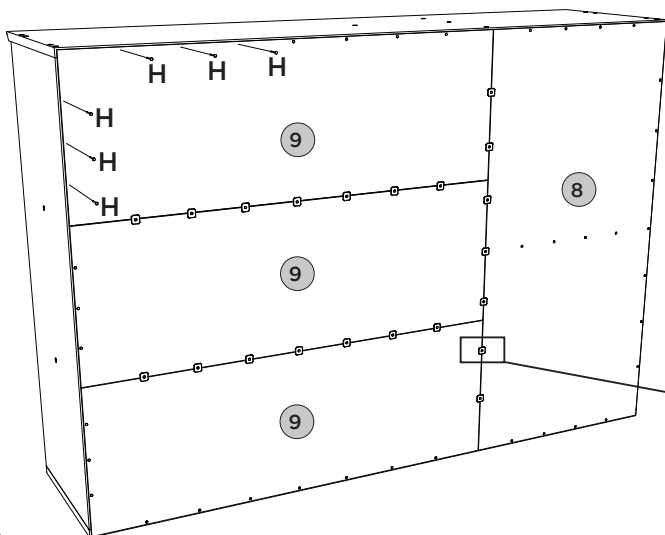
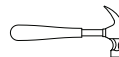

Fixar os pregos a uma distância de 100mm de um para outro.

Fijar las uñas a un distancia de 100 mm uno a otro.

Fix the nails at a distance of 100mm from one to the other

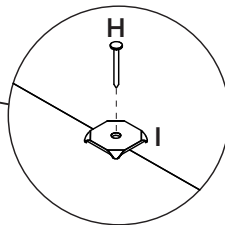



PASSO 5

ITM/C636-

PEÇAS REQUERIDAS

| | | |
|----|-------|----|
| 10 | PORTA | x3 |
|----|-------|----|

ACESSÓRIOS REQUERIDOS

| | | |
|---|-----------------------------------------------------------------------------------|----|
| F |  | 12 |
| Q |  | 06 |

FERRAMENTAS NECESSÁRIAS

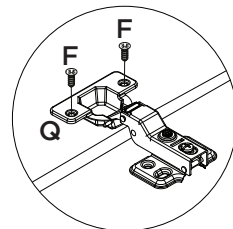
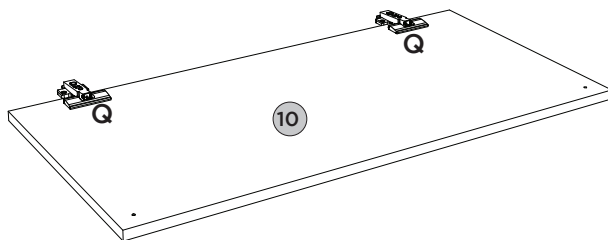
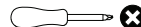



PASSO 6

PEÇAS REQUERIDAS

| | | |
|----|-------|----|
| 10 | PORTA | x3 |
|----|-------|----|

ACESSÓRIOS REQUERIDOS

| | | |
|---|-----------------------------------------------------------------------------------|----|
| C |  | 03 |
| F |  | 24 |
| K |  | 03 |

FERRAMENTAS NECESSÁRIAS



Para portas (10): Defina para o modo de perfuração.

Faça a furação passante para fixar os puxadores (K).

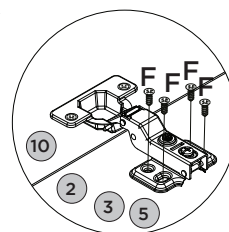
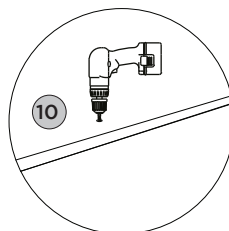
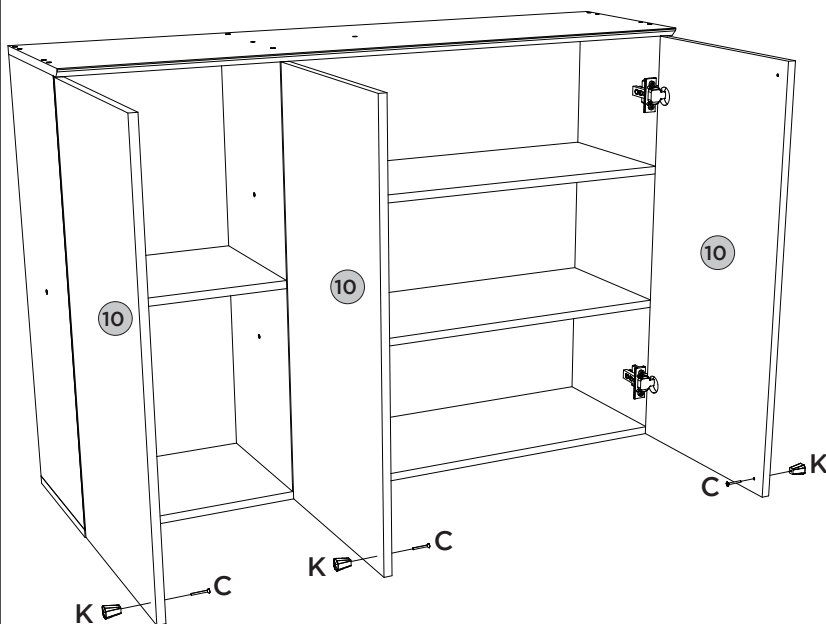

ACESSÓRIOS REQUERIDOS

FERRAMENTAS NECESSÁRIAS

| | | |
|---|--|----|
| A | | 03 |
| F | | 06 |
| J | | 03 |
| L | | 03 |

| | | |
|---|-------------|----|
| M | | 03 |
| N | | 18 |
| O | | 02 |
| R | HENN | 01 |

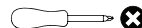

Pesos máximos recomendados com carga distribuída
 Peso máximo recomendado con la carga distribuida
 Recommended maximum weight with distributed load.

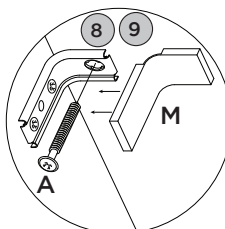
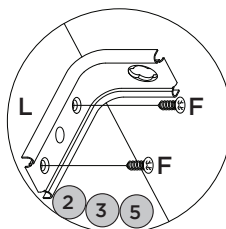
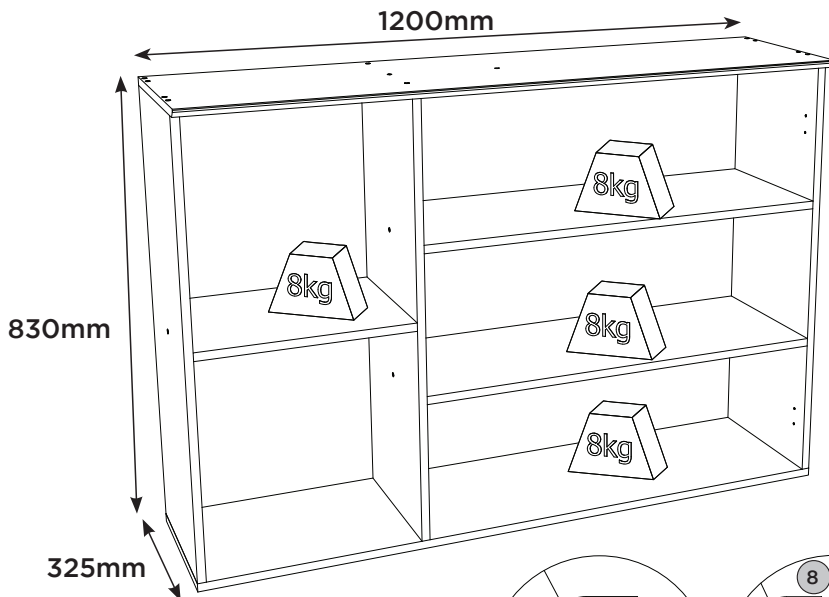

PERFECT CORRECTION
 CORRECCIÓN PERFECTA

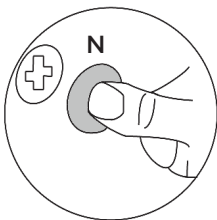
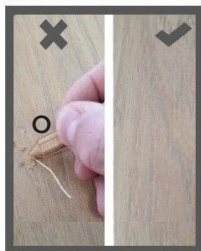

RECOMENDAÇÃO

Para fixar o móvel na parede usar o suporte de fixação (L), o parafuso 4,0x14mm CHT (F), a Bucha 8mm (J) e o parafuso 5,0x50mm FLA (A).

RECOMENDACIÓN

Para conectar el móvil a la pared con el soporte (L), tornillo 4,0x14mm CHT (F), el casquillo de 8mm (J) y el 5,0 x50mm tornillo FLA (A).

RECOMMENDATION

To fix the furniture to the wall use the fixing bracket (L), the 4.0x14mm CHT (F) screw, the 8mm bushing (J) and the 5.0x50mm FLA screw (A).

Producto Concluído
Producto terminado
Finished Product

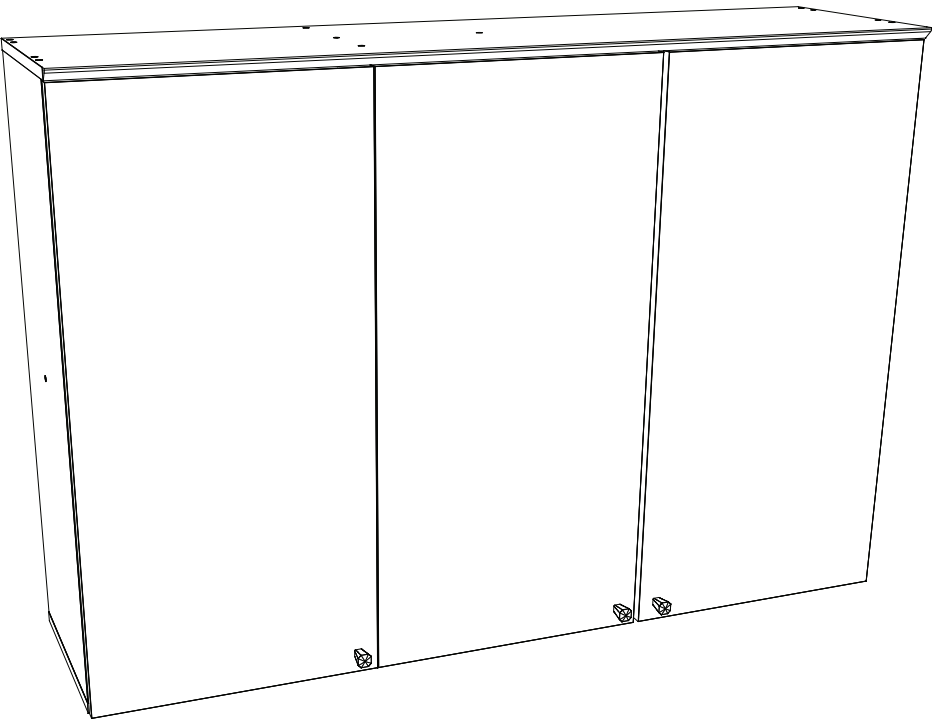

HENNInd. e Com. de Móveis Henn
Mondai - SC - Brasil

☎ +55 49 3674.3500

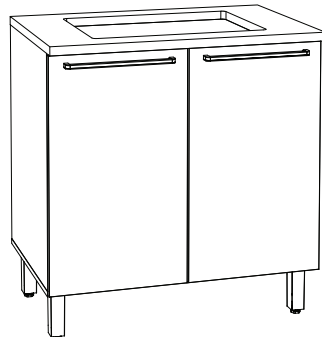
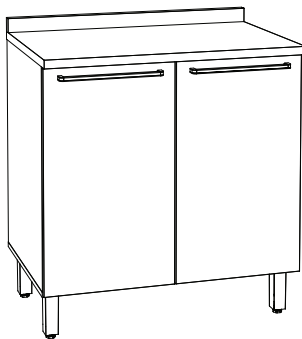
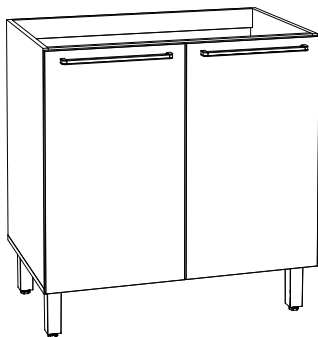
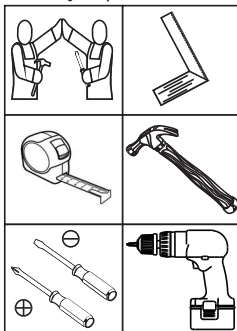
📧 @moveishenn
www.henn.com.br**INSTRUÇÕES DE
MONTAGEM**INSTRUCCIONES DE MONTAJE
ASSEMBLY INSTRUCTIONS**Balcão 02 Portas 800mm Requite |****Contador 02 Puertas 800mm Requite | Counter 02 Doors 800mm Requite****C639-217 Nature/Areia HP****Opção 01****Opción 01****Option 01****Opção 02****Opción 02****Option 02****Requisitos para montagem
Requisitos para la montaje
Assembly Requirements**

Imagens meramente ilustrativas,
não acompanha o produto.
Imágenes ilustrativas, no incluidas
con el producto.
Illustrative images, not included
with the product.

AVISO

Para limpeza de seu móvel, use uma franela seca ou umedecida, e não utilize produtos químicos que possam danificar seu produto.

SISTEMA DE MONTAGEM

O sistema de montagem dos produtos, funciona de acordo com a ordem crescente dos números indicados no desenho. Ex: 01, 02, 03, 04... até a conclusão da montagem.

ASSISTÊNCIA TÉCNICA

Para solicitação de Assistência Técnica você consumidor deverá entrar em contato com o Lojista a qual você realizou a compra deste produto e solicitar a assistência técnica das peças avariadas. A garantia abrange todas as peças, partes e componentes que eventualmente venham apresentar defeito de fabricação no prazo de 03 (três) meses, contando a partir da entrega do produto ao consumidor, mediante nota fiscal de compra. Se houver qualquer alteração na estrutura do produto ou ocorrer defeito por negligência do montador/consumidor em relação a instrução de montagem e manuseio, não será fornecido assistência técnica gratuita.

ADVERTENCIA

Para limpieza de su móvil, use una franela seca o húmeda, y no utilice productos químicos que puedan dañar su producto.

SISTEMA DE MONTAJE

El sistema de montaje de los productos funciona de acuerdo con el orden creciente de los números indicados en el dibujo. Ej.: 01, 02, 03, 04... hasta la conclusión del montaje.

ASSISTÊNCIA TÉCNICA

Para solicitar Asistencia Técnica, el consumidor debe comunicarse con el Comercio que usted realizó la compra de este producto y solicita asistencia técnica para las partes dañadas. La garantía cubre todas las partes, piezas y componentes que eventualmente puedan presentar defecto de fabricación en el plazo de 03 (tres) meses, contados a partir de la entrega del producto al consumidor, mediante factura de compra. Si se produce algún cambio en la estructura del producto o se produce un defecto por negligencia del montador/consumidor en relación con las instrucciones de montaje y manipulación, no se prestará asistencia técnica gratuita.

NOTICE

To clean your furniture, use a dry or wet cloth, and do not use chemicals that may damage your product.

ASSEMBLY SYSTEM

The products' assembly system works according to the increasing order of the indicated numbers. For example: 01, 02, 03, 04 ... to the end of the assembly.

TECHNICAL ASSISTANCE

To request Technical Assistance, the consumer must contact the retailer from whom you purchased this product and request technical assistance for the damaged parts. The warranty covers all parts, parts and components that may eventually present a manufacturing defect within a period of 03 (three) months, counting from the delivery of the product to the consumer, by means of a purchase invoice. If there is any change in the structure of the product or defect occurs due to negligence of the assembler/consumer in relation to the assembly and handling instruction, free technical assistance will not be provided.

ACESSÓRIOS | ACCESORIOS | ACCESSORIES

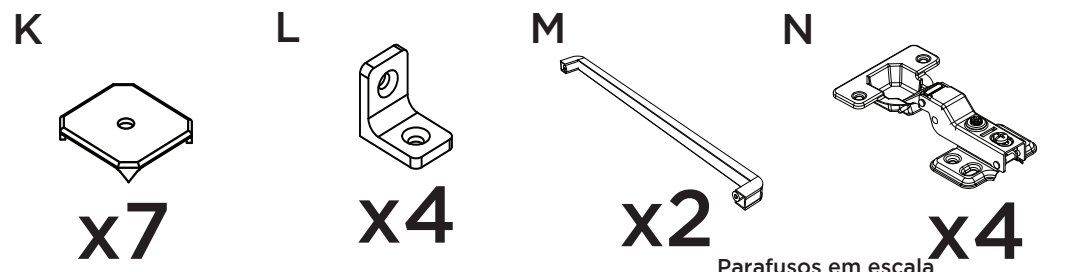
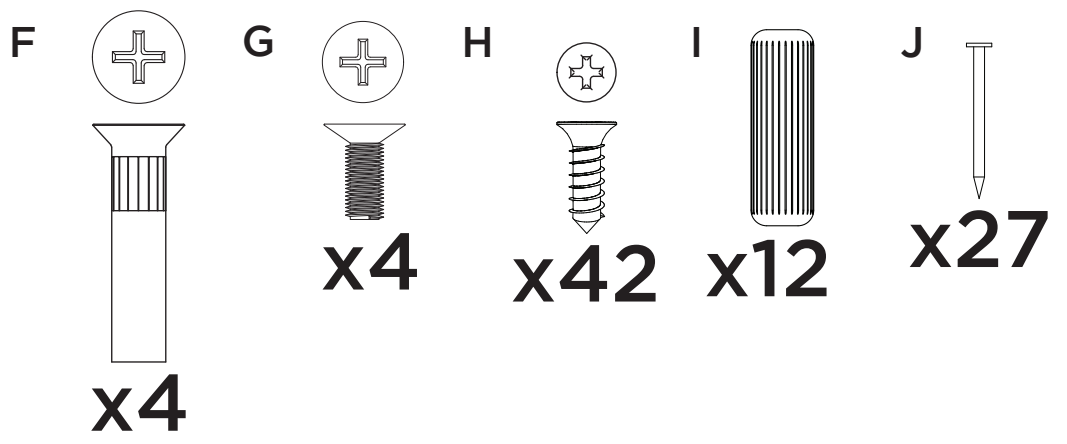
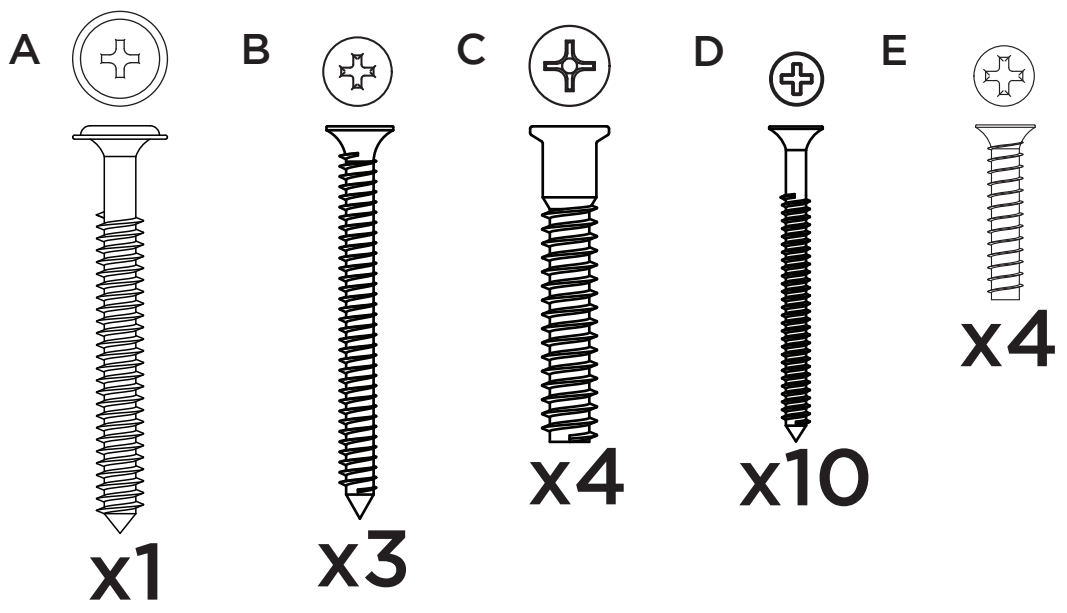

Parafusos em escala
Tornillos escalados
Scaled screws **1:1**

ACESSÓRIOS | ACCESORIOS | ACCESSORIES

O

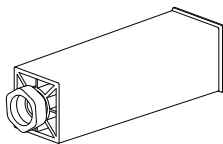

x4

P

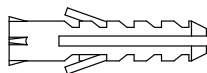

x1

Q

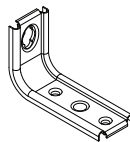

x1

R

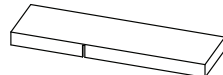

x1

S

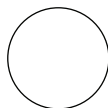

x14

T

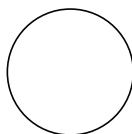

x4

U

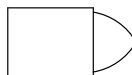

x3

V

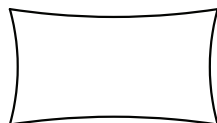

x1



Os parafusos (F/G) devem ser usados somente quando este módulo for acoplado a outro módulo componível Henn.



Los tornillos (F/G) se debe utilizar sólo cuando el módulo está conectado a otro módulo componible Henn.



Screws (F/G) are to be used only when this module is mated to another Henn buildable module.

LISTA DE PEÇAS | LISTA DE PIEZAS | LIST OF PIECES

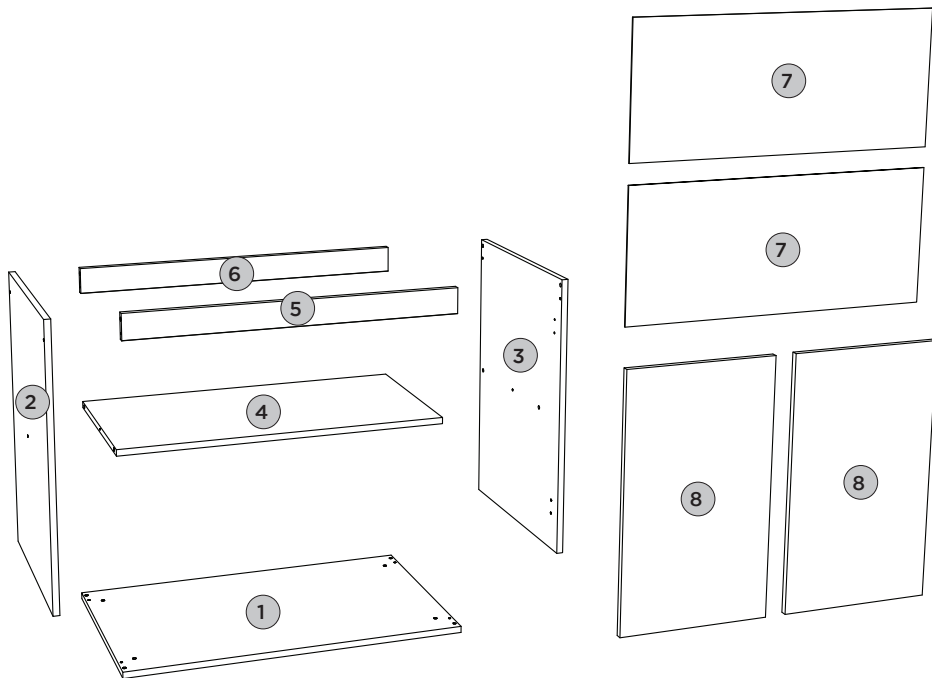

| Item | Caixa Caja Box | Qtd Ctd Qty | Descrição Descripción Description | Dimensões (mm) Dimensiones (mm) Dimensions (mm) | | |
|------|----------------------|-------------------|----------------------------------------------------------|--------------------------------------------------------|---------------------------|----------------------------------|
| | | | | Comprimento Largo Length | Largura Ancho Width | Espessura Grosor Thickness |
| 1 | 1/1 | 01 | BASE BASE BASE | 800 | 490 | 15 |
| 2 | 1/1 | 01 | LATERAL ESQUERDA LATERAL IZQUIERDA LEFT SIDE | 660 | 490 | 15 |
| 3 | 1/1 | 01 | LATERAL DIREITA LATERAL DERECHA RIGHT SIDE | 660 | 490 | 15 |
| 4 | 1/1 | 01 | PRATELEIRA ESTANTE SHELF | 768 | 400 | 15 |
| 5 | 1/1 | 01 | TRAVESSA FRONTAL TRAVESAÑO FRONTAL FRONT CROSSBAR | 768 | 60 | 15 |
| 6 | 1/1 | 01 | TRAVESSA TRASEIRA TRAVESAÑO TRASERO REAR BUMPER | 768 | 60 | 15 |
| 7 | 1/1 | 02 | FUNDO FONDO BOTTOM | 792 | 335 | 3 |
| 8 | 1/1 | 02 | PORTA PUERTA DOOR | 665 | 396 | 15 |





PASSO 1

ITM/C639-

PEÇAS REQUERIDAS

| | | |
|---|-------------------|----|
| 1 | BASE | x1 |
| 2 | LATERAL ESQUERDA | x1 |
| 3 | LATERAL DIREITA | x1 |
| 4 | PRATELEIRA | x1 |
| 5 | TRAVESSA FRONTAL | x1 |
| 6 | TRAVESSA TRASEIRA | x1 |

ACESSÓRIOS REQUERIDOS

| | | |
|---|-----------------------------------------------------------------------------------|----|
| C |  | 04 |
| I |  | 12 |
| O |  | 04 |
| V |  | |

FERRAMENTAS NECESSÁRIAS

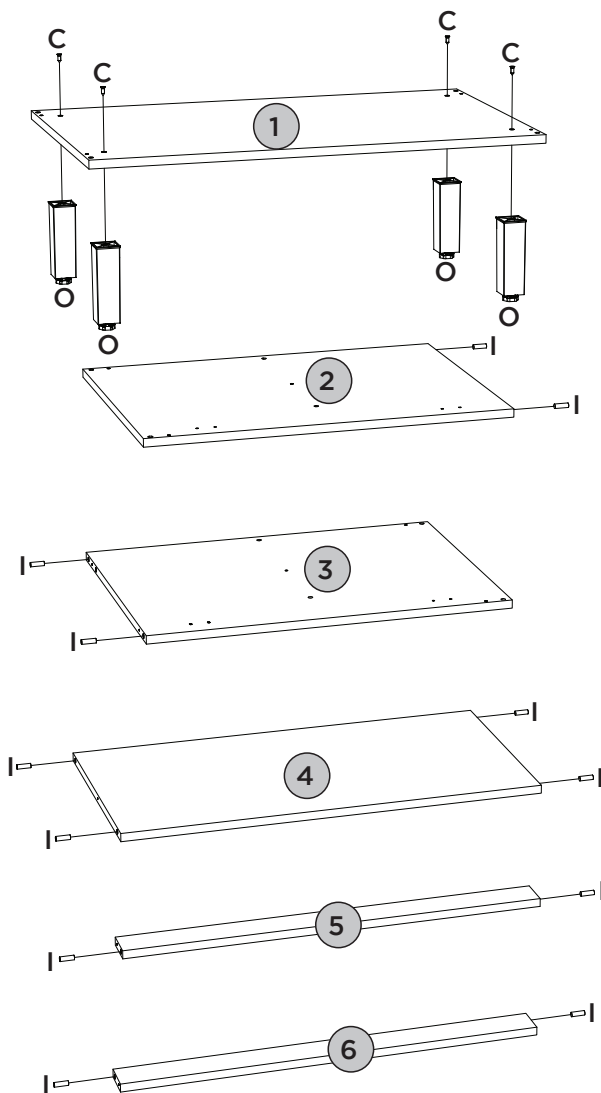
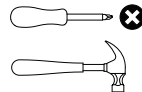

Utilizar o sachê de cola (V) em todas as cavilhas (I) do produto.

Con el pegamento sobre (V) en todos los pernos (I) producto.

Use the glue sachet (V) on all the pegs (I) of the product.



PASSO 2

ITM/C639-

PEÇAS REQUERIDAS

| | | |
|---|-------------------|----|
| 1 | BASE | x1 |
| 2 | LATERAL ESQUERDA | x1 |
| 3 | LATERAL DIREITA | x1 |
| 4 | PRATELEIRA | x1 |
| 5 | TRAVESSA FRONTAL | x1 |
| 6 | TRAVESSA TRASEIRA | x1 |



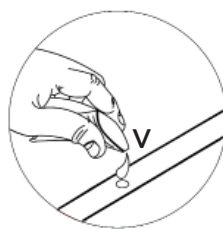
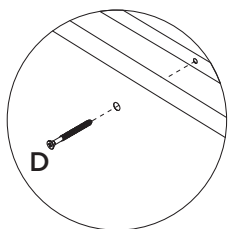
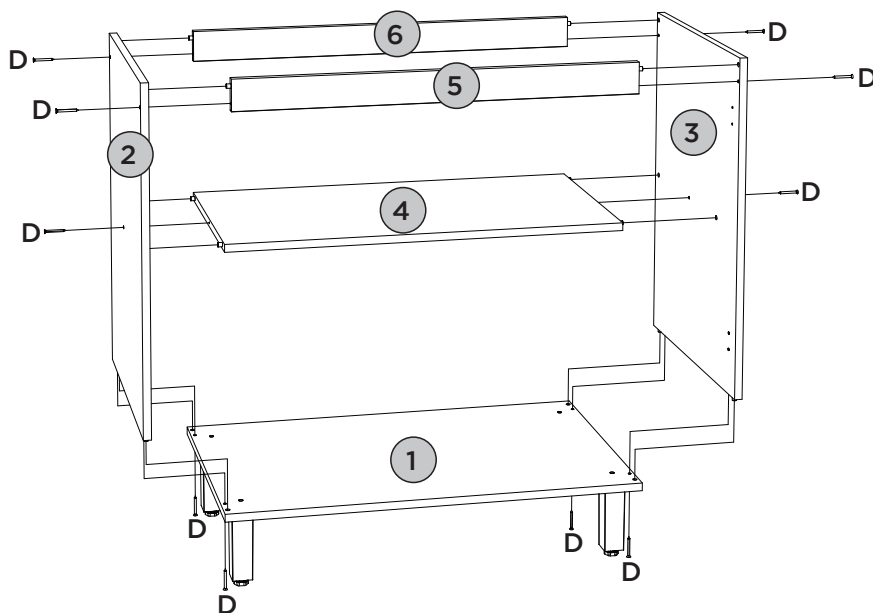
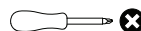

ACESSÓRIOS REQUERIDOS

| | | | |
|---|-----------------------------------------------------------------------------------|-----------------------------------------------------------------------------------|----|
| D |  |  | 10 |
| V |  | | |

FERRAMENTAS NECESSÁRIAS



ACESSÓRIOS REQUERIDOS

| | | | |
|---|-----------------------------------------------------------------------------------|-----------------------------------------------------------------------------------|----|
| B |  |  | 03 |
| H |  |  | 08 |
| L |  | | 04 |

FERRAMENTAS NECESSÁRIAS

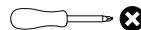

Esse tampo é opcional e é vendido separadamente (C904-128).

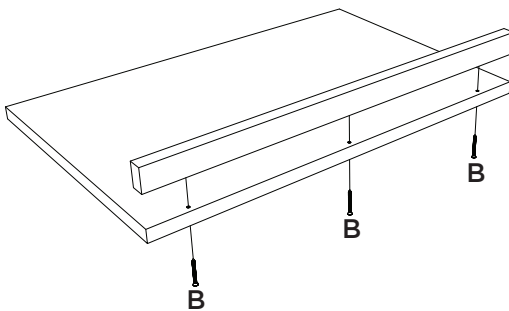

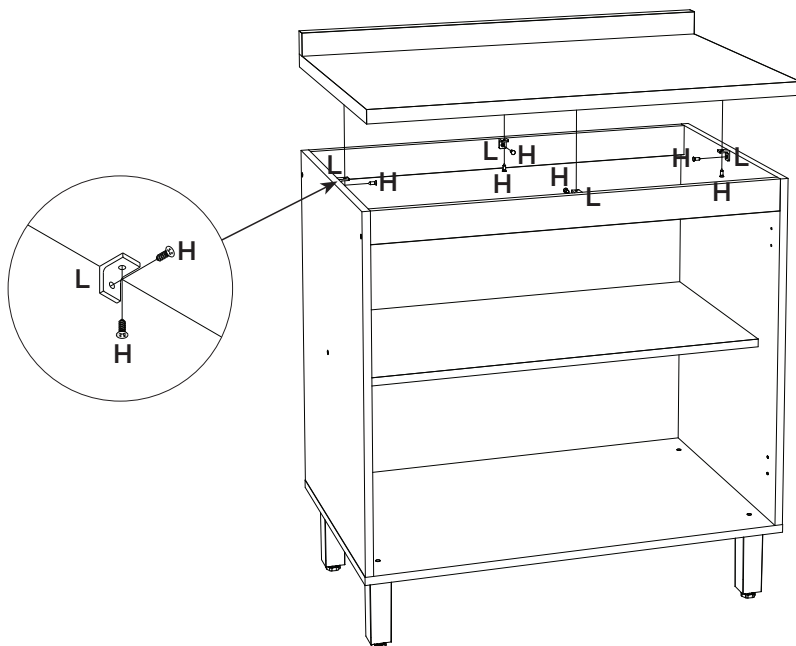

Esta vez es opcional y se vende por separado (C904-128).

This top is optional and is sold separately (C904-128).



ACESSÓRIOS REQUERIDOS

| | | | |
|---|-----------------------------------------------------------------------------------|----------------------------------------------------------------------------------|----|
| H |  |  | 08 |
| L |  | | 04 |

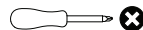
FERRAMENTAS NECESSÁRIAS

Esse tampo é opcional e é vendido separadamente (C908-128).

Esta vez es opcional y se vende por separado (C908-128).

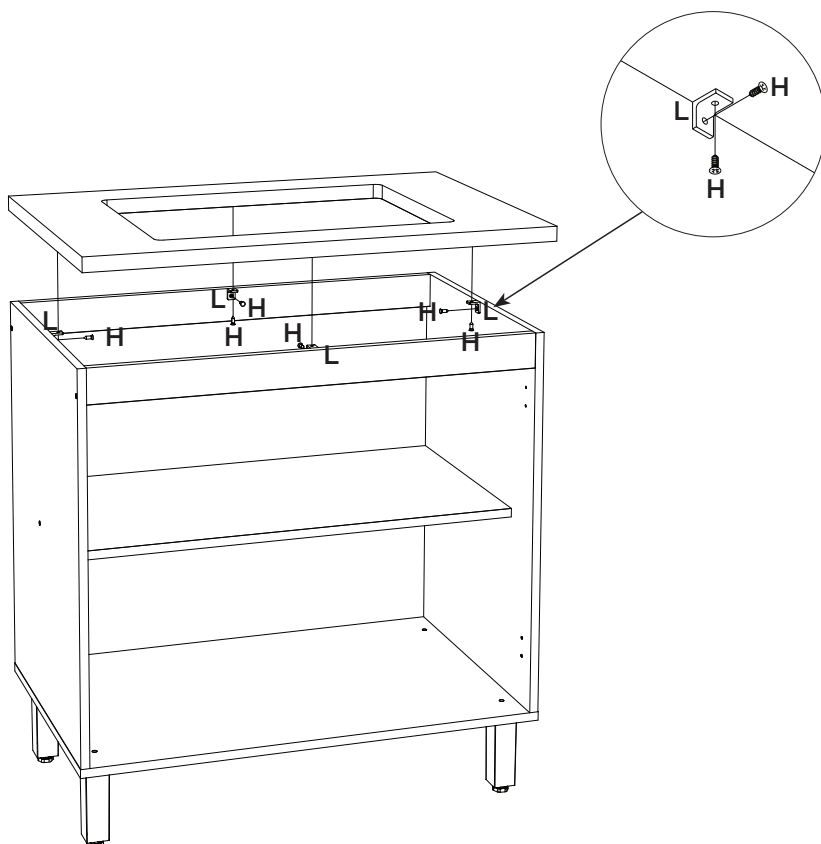

This top is optional and is sold separately (C908-128).



PEÇAS REQUERIDAS

| | | |
|---|-------|----|
| 7 | FUNDO | x2 |
|---|-------|----|

ACESSÓRIOS REQUERIDOS

| | | |
|---|-----------------------------------------------------------------------------------|----|
| H |  | 08 |
| J |  | 27 |
| K |  | 07 |

FERRAMENTAS NECESSÁRIAS

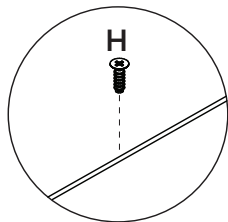
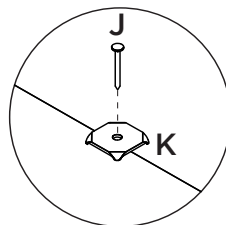
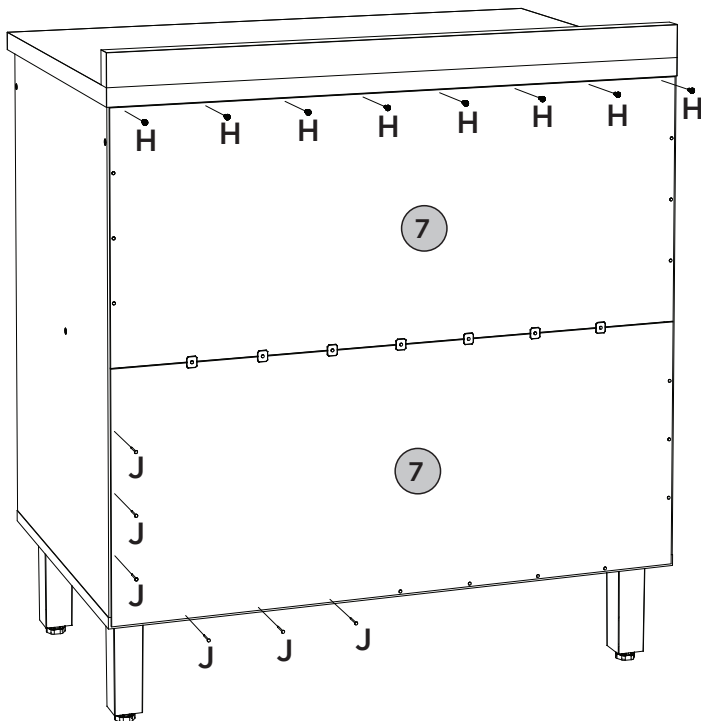
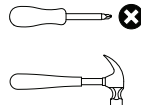

Fixar os pregos a uma distância de 100mm de um para outro.



Fijar las uñas a un distancia de 100mm uno a otro.

Fix the nails at a distance of 100mm from one to the other

PASSO 6**PEÇAS REQUERIDAS**

| | | |
|---|-------|----|
| 8 | PORTA | x2 |
|---|-------|----|

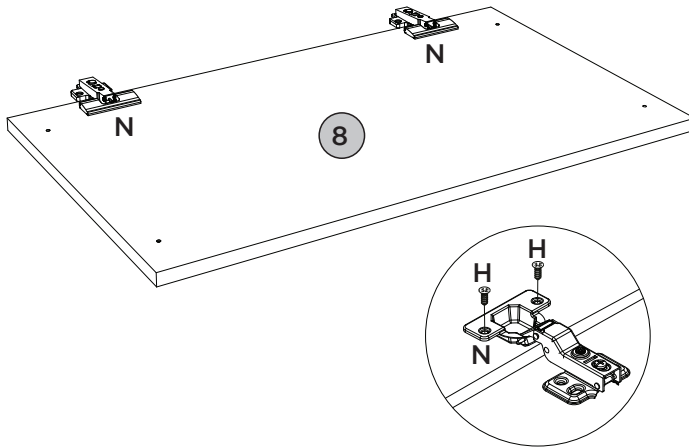
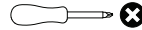

ACESSÓRIOS REQUERIDOS

| | | |
|---|-----------------------------------------------------------------------------------|----|
| H |  | 08 |
| N |  | 04 |

FERRAMENTAS NECESSÁRIAS**PASSO 7****PEÇAS REQUERIDAS**

| | | |
|---|-------|----|
| 8 | PORTA | x2 |
|---|-------|----|

ACESSÓRIOS REQUERIDOS

| | | |
|---|-----------------------------------------------------------------------------------|----|
| E |  | 04 |
| H |  | 16 |
| M |  | 02 |

FERRAMENTAS NECESSÁRIAS

Para porta (8): Defina para o modo de perfuração.

Faça a furação passante para fixar o puxador (M).

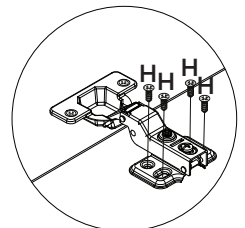
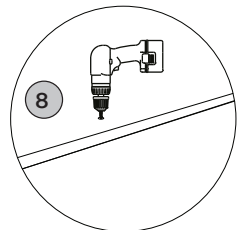
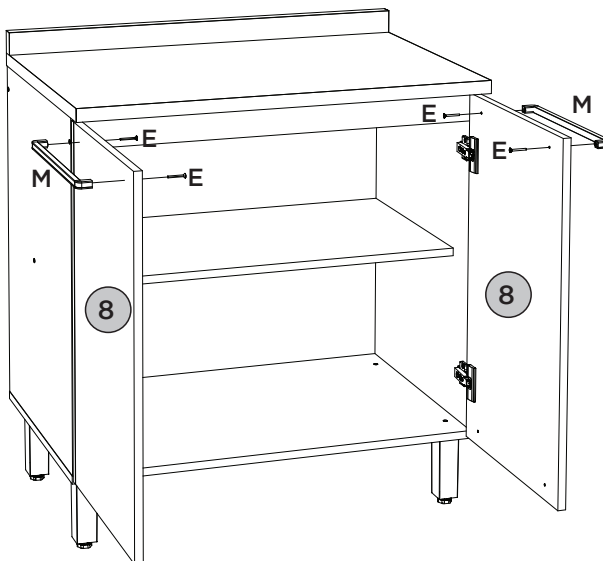

ACESSÓRIOS REQUERIDOS

| | | | | | |
|---|--|----|---|--|----|
| A | | 01 | R | | 01 |
| H | | 02 | S | | 14 |
| P | | 01 | T | | 04 |
| Q | | 01 | U | | 03 |

FERRAMENTAS NECESSÁRIAS

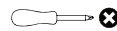

OU



Para parede: Ajustar no modo perfuração

Pesos máximos recomendados com carga distribuída
Peso máximo recomendado con la carga distribuida
Recommended maximum weight with distributed load.

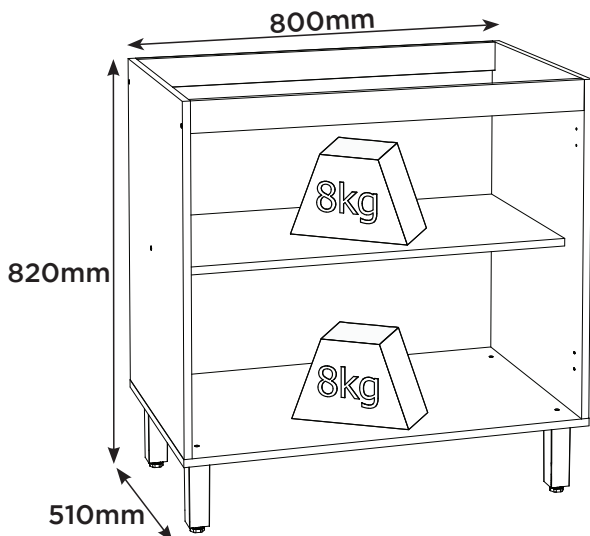

PERFECT CORRECTION
CORRECCIÓN PERFECTA

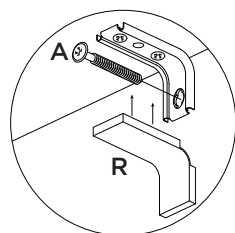
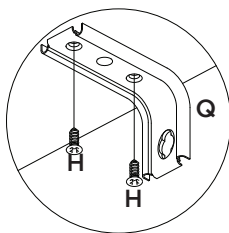
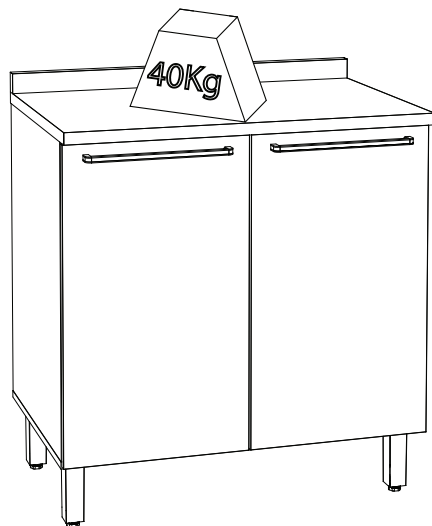
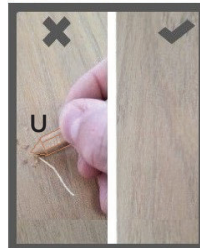

RECOMENDAÇÃO

Para fixar o móvel na parede usar o suporte de fixação (Q), o parafuso 4,0x14mm CHT (H), a Bucha 8mm (P) e o parafuso 5,0x50mm FLA (A).

RECOMENDACIÓN

Para conectar el móvil a la pared con el soporte (Q), tornillo 4,0x14mm CHT (H), el casquillo de 8 mm (P) y el 5,0 x50mm tornillo FLA (A).

RECOMMENDATION

To fix the furniture to the wall use the fixing bracket (Q), the 4,0x14mm CHT (H) screw, the 8mm bushing (P) and the 5.0x50mm FLA screw (A).

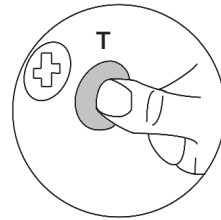
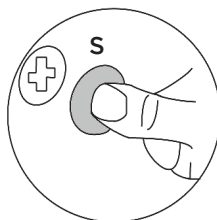

Produto Concluído
Producto terminado
Finished Product

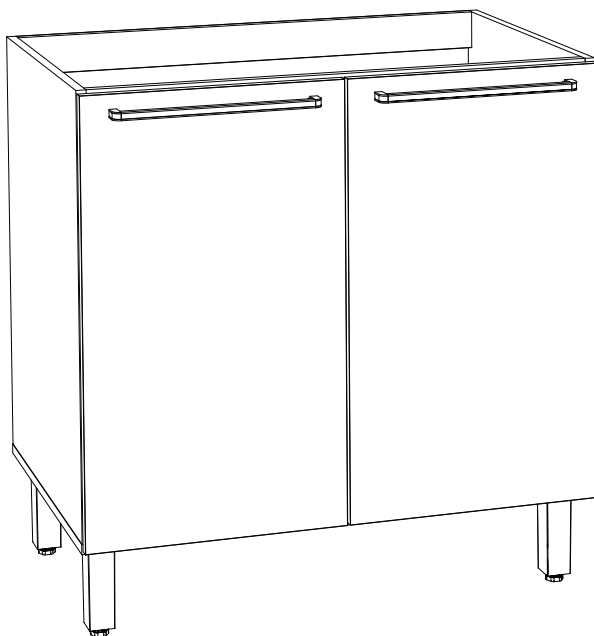

HENNInd. e Com. de Móveis Henn
Mondai - SC - Brasil

☎ +55 49 3674.3500

📧 @moveishenn
www.henn.com.br**INSTRUÇÕES DE
MONTAGEM**INSTRUCCIONES DE MONTAJE
ASSEMBLY INSTRUCTIONS**Balcão Pia 02 Gavetas 03 Portas Requinte |**
Pia Contador 02 Cajones 03 Puertas Requinte |
Balcony Pia 02 Drawers 03 Doors Requinte

C640-217 Nature/Areia

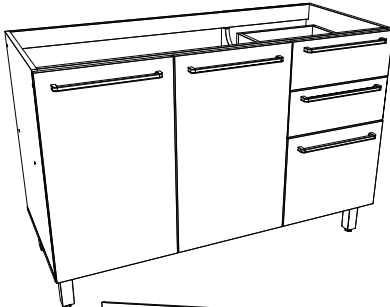
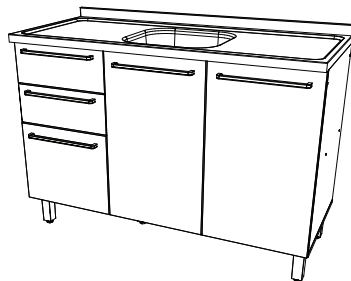
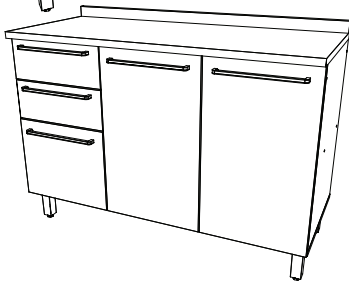
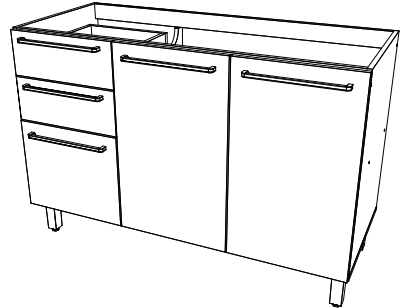
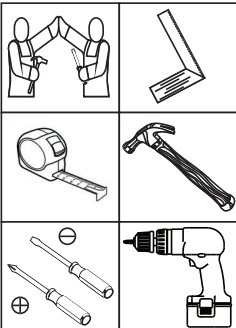
Opção 01
Opción 01
Option 01Opção 02
Opción 02
Option 02Requisitos para montagem
Requisitos para la montaje
Assembly RequirementsImagens meramente ilustrativas,
não acompanha o produto.
Imágenes ilustrativas, no incluidas
con el producto.
Illustrative images, not included
with the product.**AVISO**

Para limpeza de seu móvel, use uma flanela seca ou umedecida, e não utilize produtos químicos que possam danificar seu produto.

SISTEMA DE MONTAGEM

O sistema de montagem dos produtos, funciona de acordo com a ordem crescente dos números indicados no desenho. Ex: 01, 02, 03, 04... até a conclusão da montagem.

ASSISTÊNCIA TÉCNICA

Para solicitação de Assistência Técnica você consumidor deverá entrar em contato com o Lojista a qual você realizou a compra deste produto e solicitar a assistência técnica das peças avariadas. A garantia abrange todas as peças, partes e componentes que eventualmente venham apresentar defeito de fabricação no prazo de 03 (três) meses, contando a partir da entrega do produto ao consumidor, mediante nota fiscal de compra. Se houver qualquer alteração na estrutura do produto ou ocorrer defeito por negligência do montador/consumidor em relação a instrução de montagem e manuseio, não será fornecido assistência técnica gratuita.

ADVERTENCIA

Para limpieza de su móvil, use una flanela seca o húmeda, y no utilice productos químicos que puedan dañar su producto.

SISTEMA DE MONTAJE

El sistema de montaje de los productos funciona de acuerdo con el orden creciente de los números indicados en el dibujo. Ej.: 01, 02, 03, 04... hasta la conclusión del montaje.

ASSISTENCIA TÉCNICA

Para solicitar Asistencia Técnica, el consumidor debe comunicarse con el Comercio que usted realizó la compra de este producto y solicita asistencia técnica para las partes dañadas. La garantía cubre todas las partes, piezas y componentes que eventualmente puedan presentar defecto de fabricación en el plazo de 03 (tres) meses, contados a partir de la entrega del producto al consumidor, mediante factura de compra. Si se produce algún cambio en la estructura del producto o se produce un defecto por negligencia del montador/consumidor en relación con las instrucciones de montaje y manipulación, no se prestará asistencia técnica gratuita.

NOTICE

To clean your furniture, use a dry or wet cloth, and do not use chemicals that may damage your product.

ASSEMBLY SYSTEM

The products' assembly system works according to the increasing order of the indicated numbers. For example: 01, 02, 03, 04 ... to the end of the assembly.

TECHNICAL ASSISTANCE

To request Technical Assistance, the consumer must contact the retailer from whom you purchased this product and request technical assistance for the damaged parts. The warranty covers all parts, parts and components that may eventually present a manufacturing defect within a period of 03 (three) months, counting from the delivery of the product to the consumer, by means of a purchase invoice. If there is any change in the structure of the product or defect occurs due to negligence of the assembler/consumer in relation to the assembly and handling instruction, free technical assistance will not be provided.

ACESSÓRIOS | ACCESORIOS | ACCESSORIES

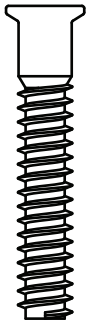

x5

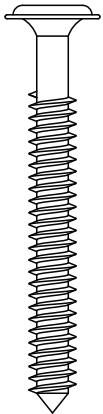

x2



x4



x2



x14

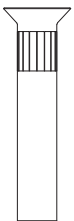

x6

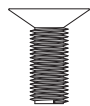

x6



x98



x4



x10

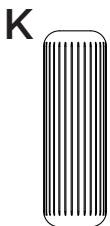

x32



x38



x13



Os parafusos (F/G) devem ser usados somente quando este módulo for acoplado a outro módulo componível Henn.



Los tornillos (F/G) se debe utilizar sólo cuando el módulo está conectado a otro módulo componible Henn.



Screws (F/G) are to be used only when this module is mated to another Henn buildable module.

Parafusos em escada
Tornillos escalados
Scaled screws **1:1**

ACESSÓRIOS | ACCESORIOS | ACCESSORIES

N

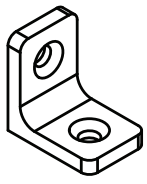

x11

O

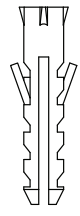

x2

P

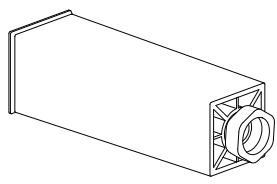

x5

Q

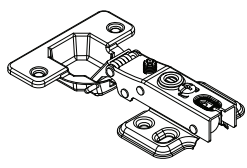

x6

R

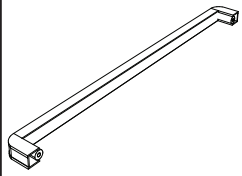

x5

S

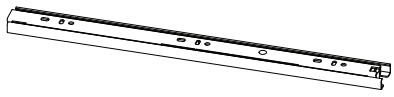

x2

T

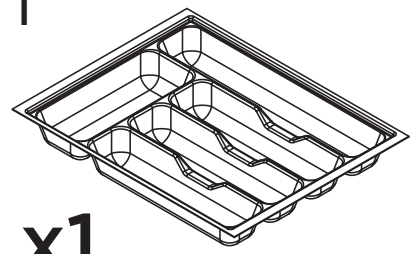

x1

U

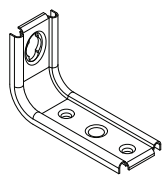

x2

V

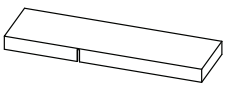

x2

W

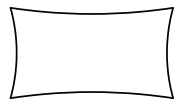

x2

X

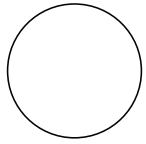

x6

Y



x26

Z

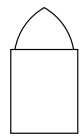

x3

AA



x1

LISTA DE PEÇAS | LISTA DE PIEZAS | LIST OF PIECES

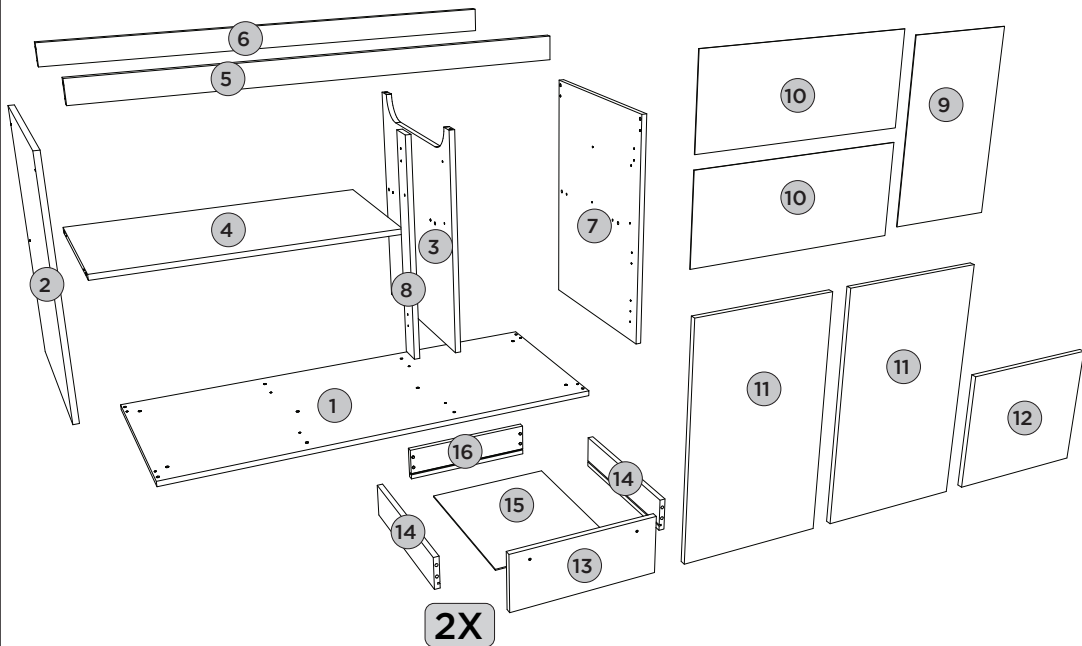

| Item | Caixa Caja Box | Qty Ctd Qty | Descrição Descripción Description | Dimensões (mm) Dimensiones (mm) | | |
|------|----------------------|-------------------|--------------------------------------------------------------------|-----------------------------------|---------------------------|----------------------------------|
| | | | | Comprimento Largo Length | Largura Ancho Width | Espessura Grosor Thickness |
| 1 | 1/1 | 01 | BASE BASE BASE | 1200 | 490 | 15 |
| 2 | 1/1 | 01 | LATERAL ESQUERDA LATERAL IZQUIERDA LEFT SIDE | 660 | 490 | 15 |
| 3 | 1/1 | 01 | DIVISÃO DIVISIÓN DIVISION | 600 | 490 | 15 |
| 4 | 1/1 | 01 | PRATELEIRA ESTANTE SHELF | 783 | 400 | 15 |
| 5 | 1/1 | 01 | TRAVESSA FRONTAL TRAVESAÑO FRONTAL FRONT CROSSBAR | 1168 | 60 | 15 |
| 6 | 1/1 | 01 | TRAVESSA TRASEIRA TRAVESAÑO TRASERO REAR BUMPER | 1168 | 60 | 15 |
| 7 | 1/1 | 01 | LATERAL DIREITA LATERAL DERECHA RIGHT SIDE | 660 | 490 | 15 |
| 8 | 1/1 | 01 | PILASTRA DA PORTA PILASTRA PUERTA PILASTER DOOR | 597 | 60 | 15 |
| 9 | 1/1 | 01 | FUNDO MENOR FONDO MENOR MINOR FUND | 672 | 389 | 3 |
| 10 | 1/1 | 02 | FUNDO FONDO BOTTOM | 802 | 335 | 3 |
| 11 | 1/1 | 02 | PORTA PUERTA DOOR | 665 | 396 | 15 |
| 12 | 1/1 | 01 | PORTA MENOR PUERTA MENOR SMALLER DOOR | 396 | 337 | 15 |
| 13 | 1/1 | 02 | FRENTE DE GAVETA FRENTE DE CAJÓN FRONT OF DRAWER | 396 | 160 | 15 |
| 14 | 1/1 | 04 | LADO DE GAVETA MENOR LADO DEL CAJÓN MENOR SMALLEST DRAWER SIDE | 400 | 90 | 15 |
| 15 | 1/1 | 02 | FUNDO DE GAVETA FONDO DE CAJÓN BOTTOM OF DRAWER | 411 | 326 | 3 |
| 16 | 1/1 | 02 | RIPA DE TRÁS MALLA DETRÁS REAR LATH | 345 | 90 | 15 |





PASSO 1

ITM/C640-

PEÇAS REQUERIDAS

| | | |
|---|-------------------|----|
| 1 | BASE | x1 |
| 4 | PRATELEIRA | x1 |
| 5 | TRAVESSA FRONTAL | x1 |
| 6 | TRAVESSA TRASEIRA | x1 |

ACESSÓRIOS REQUERIDOS

| | | |
|---|-----------------------------------------------------------------------------------|----|
| A |  | 05 |
| K |  | 08 |
| P |  | 05 |
| W |  | |

FERRAMENTAS NECESSÁRIAS

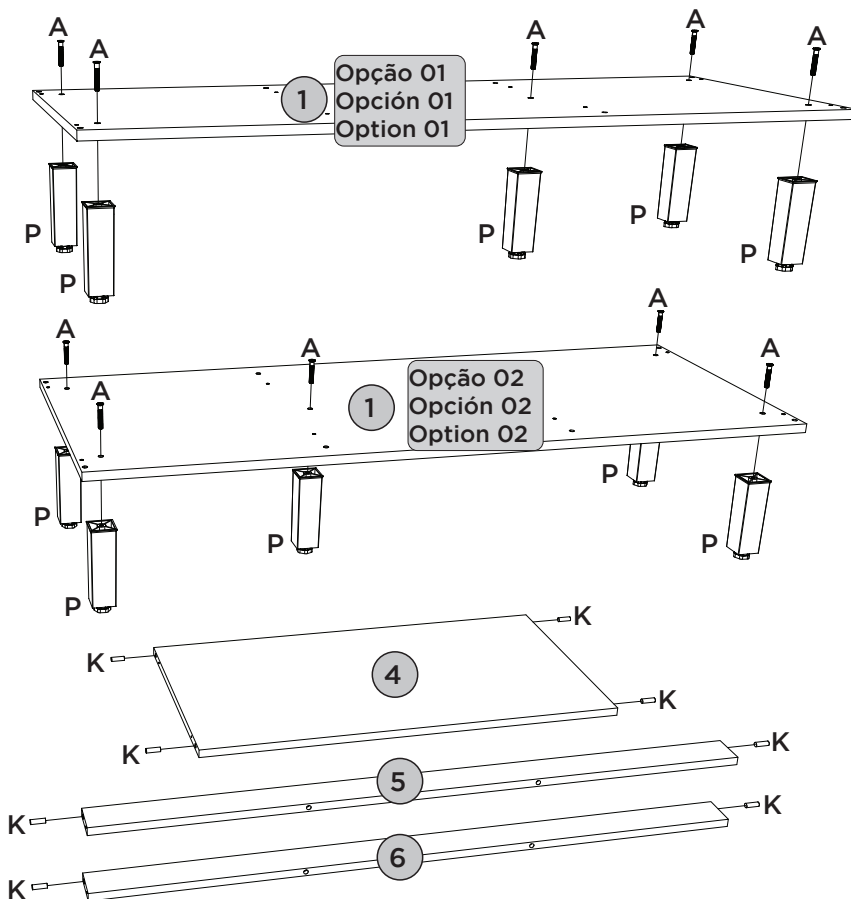
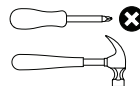

Utilizar o sachê de cola (W) em todas as cavilhas (K) do produto.

Con el pegamento sobre (W) en todos los pernos (K) producto.

Use the glue sachet (W) on all the pegs (K) of the product.

PASSO 2

ITM/C640-

PEÇAS REQUERIDAS

| | | |
|---|------------------|----|
| 2 | LATERAL ESQUERDA | x1 |
| 3 | DIVISÃO | x1 |
| 7 | LATERAL DIREITA | x1 |

ACESSÓRIOS REQUERIDOS

| | | |
|---|--|----|
| H | | 12 |
| K | | 08 |
| S | | 04 |
| W | | |

FERRAMENTAS NECESSÁRIAS

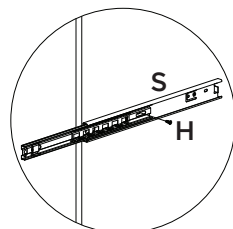
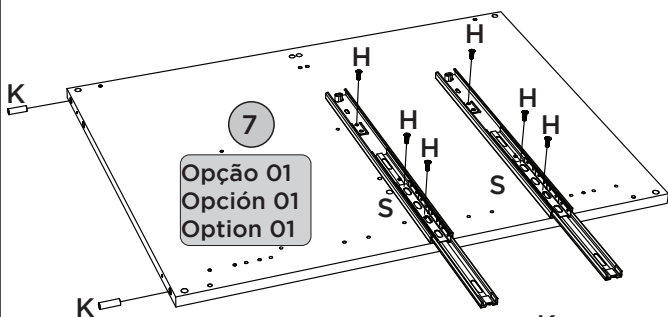
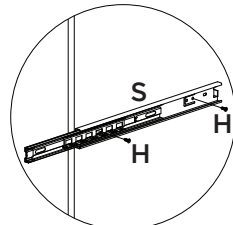
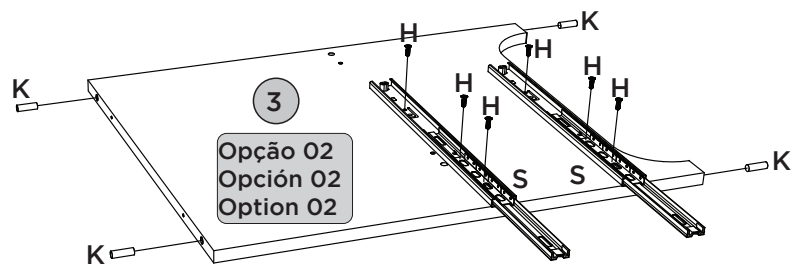
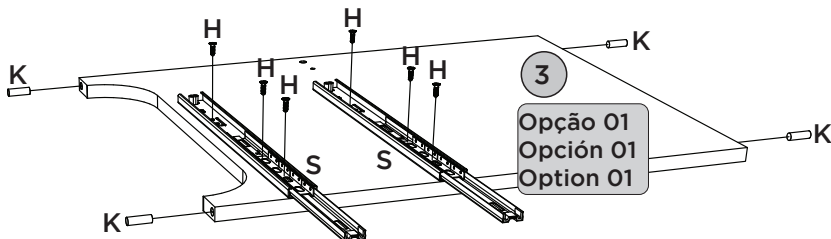
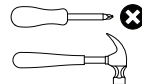

Na Opção 01 a Lateral Esquerda (02) ficará apenas com cavilhas (K), assim como na opção 02 a Lateral Direita (07) ficará apenas com cavilhas (K).

En la Opción 01 el Lado Izquierdo (02) solo tendrá pasadores (K), al igual que en la opción 02 el Lado Derecho (07) solo tendrá pasadores (K).

In Option 01 the Left Side (02) will only have pins (K), just as in option 02 the Right Side (07) will only have pins (K).



PASSO 3

ITM/C640-

PEÇAS REQUERIDAS

| | | |
|---|-------------------|----|
| 1 | BASE | x1 |
| 2 | LATERAL ESQUERDA | x1 |
| 3 | DIVISÃO | x1 |
| 4 | PRATELEIRA | x1 |
| 5 | TRAVESSA FRONTAL | x1 |
| 6 | TRAVESSA TRASEIRA | x1 |
| 7 | LATERAL DIREITA | x1 |

ACESSÓRIOS REQUERIDOS

| | | |
|---|-----------------------------------------------------------------------------------|----|
| E |  | 10 |
| W |  | |

FERRAMENTAS NECESSÁRIAS

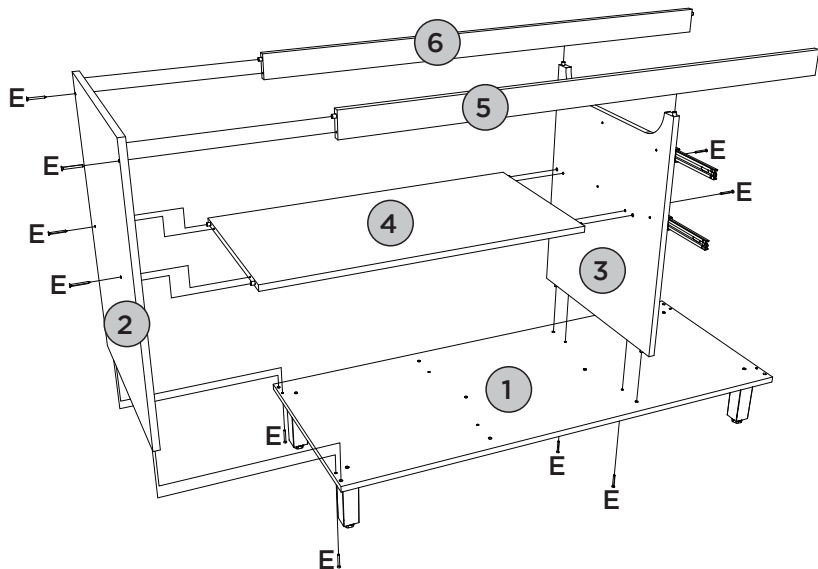
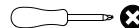

Opção 01
Opción 01
Option 01



Opção 02
Opción 02
Option 02

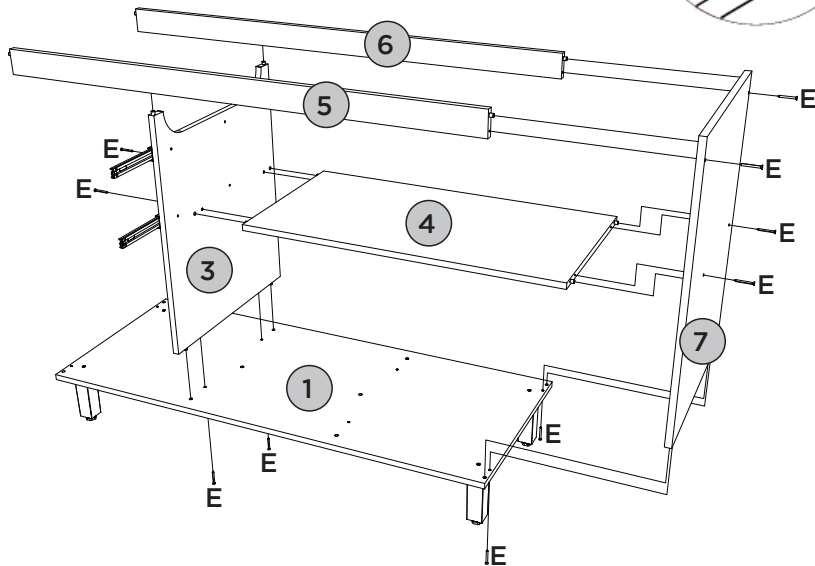





PASSO 4

ITM/C640-

PEÇAS REQUERIDAS

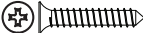
| | | |
|---|-------------------|----|
| 2 | LATERAL ESQUERDA | x1 |
| 7 | LATERAL DIREITA | x1 |
| 8 | PILASTRA DA PORTA | x1 |

ACESSÓRIOS REQUERIDOS

| | | |
|---|-----------------------------------------------------------------------------------|----|
| D |  | 02 |
| E |  | 04 |
| H |  | 02 |
| N |  | 01 |
| W |  | |

FERRAMENTAS NECESSÁRIAS





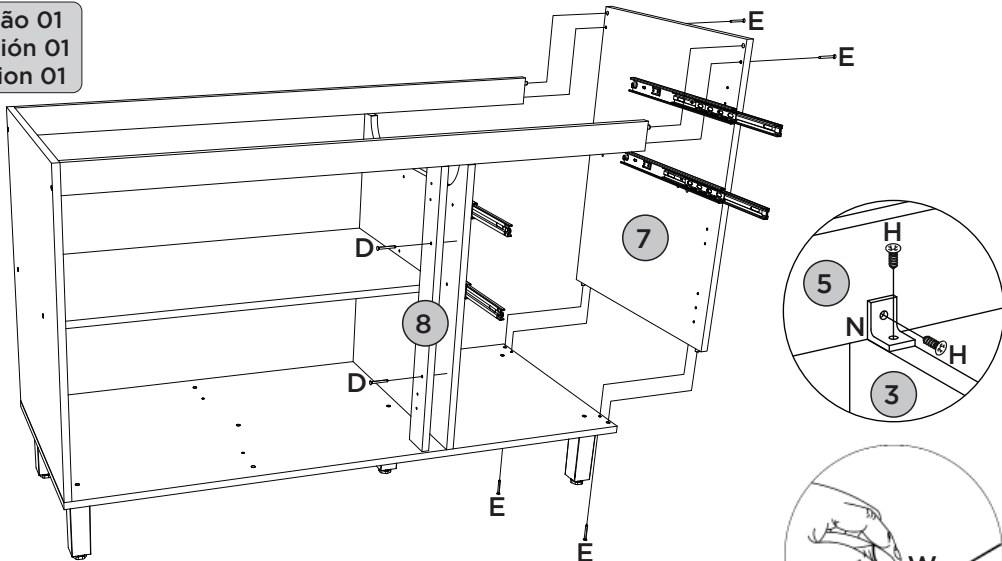

Opção 01
Opción 01
Option 01

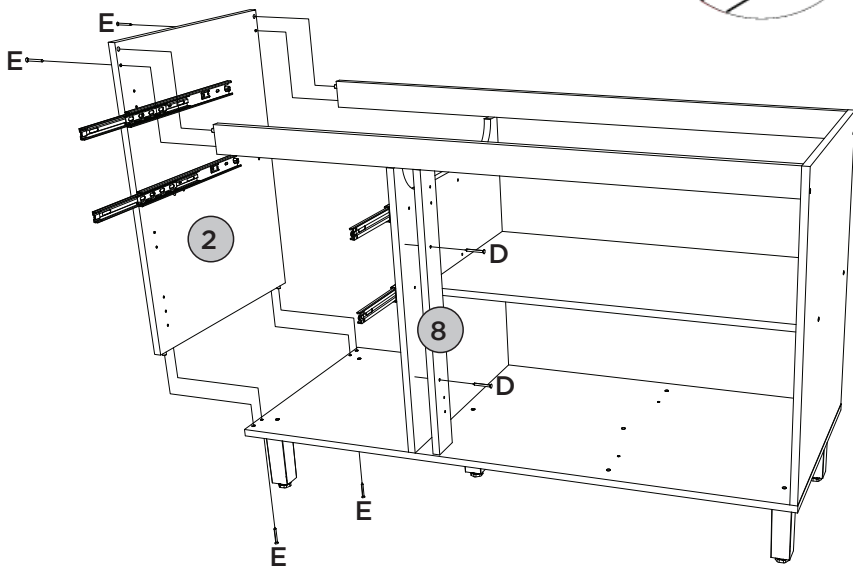

Opção 02
Opción 02
Option 02



ACESSÓRIOS REQUERIDOS

| | | | |
|---|-----------------------------------------------------------------------------------|-----------------------------------------------------------------------------------|----|
| C |  |  | 04 |
| H |  |  | 12 |
| N |  | | 06 |

FERRAMENTAS NECESSÁRIAS



Esse tampo é opcional e é vendido separadamente (C905-128).

Esta vez es opcional y se vende por separado (C905-128).

This top is optional and is sold separately (C905-128).

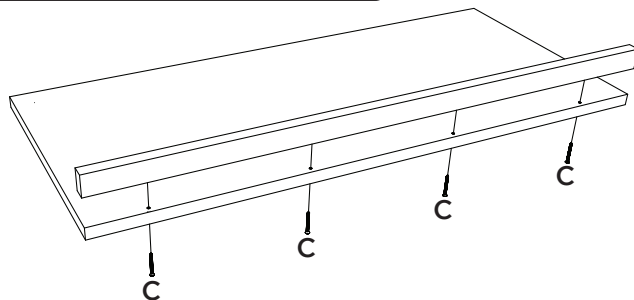

Opção 01
Opción 01
Option 01

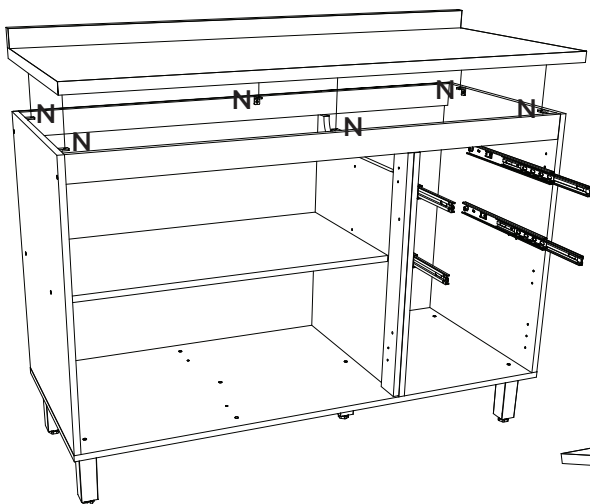

Opção 02
Opción 02
Option 02

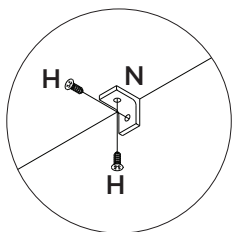
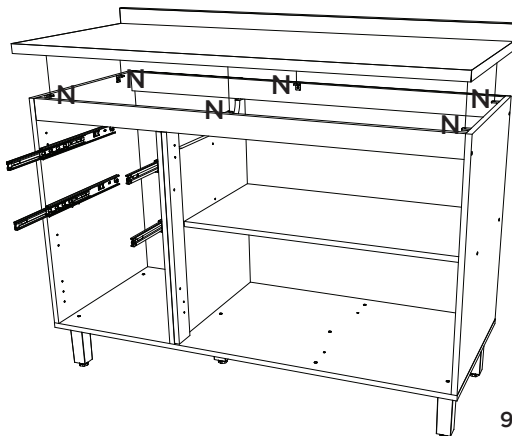



PASSO 6

ITM/C640-

PEÇAS REQUERIDAS

| | | |
|----|-------------|----|
| 9 | FUNDO MENOR | x1 |
| 10 | FUNDO | x2 |

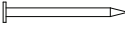
ACESSÓRIOS REQUERIDOS

| | | |
|---|-----------------------------------------------------------------------------------|----|
| H |  | 12 |
| L |  | 38 |
| M |  | 13 |

FERRAMENTAS NECESSÁRIAS

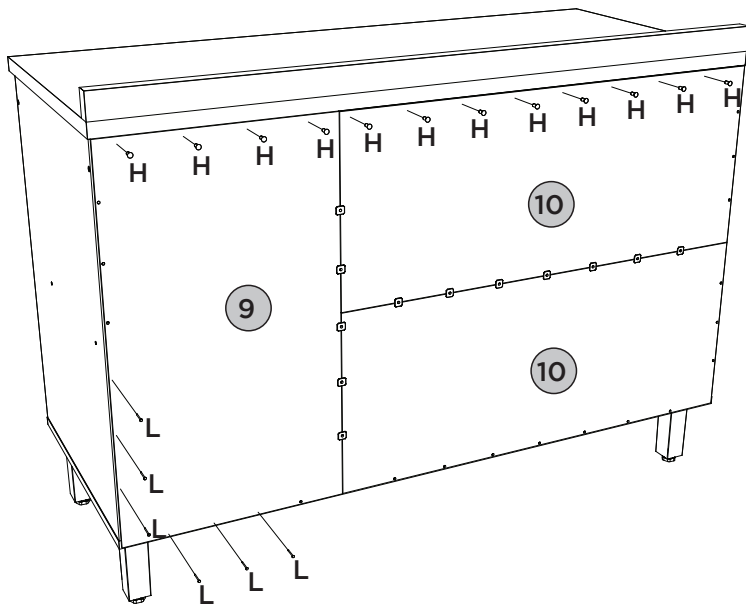
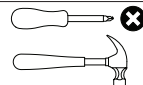

Opção 01
Opción 01
Option 01

Opção 02
Opción 02
Option 02

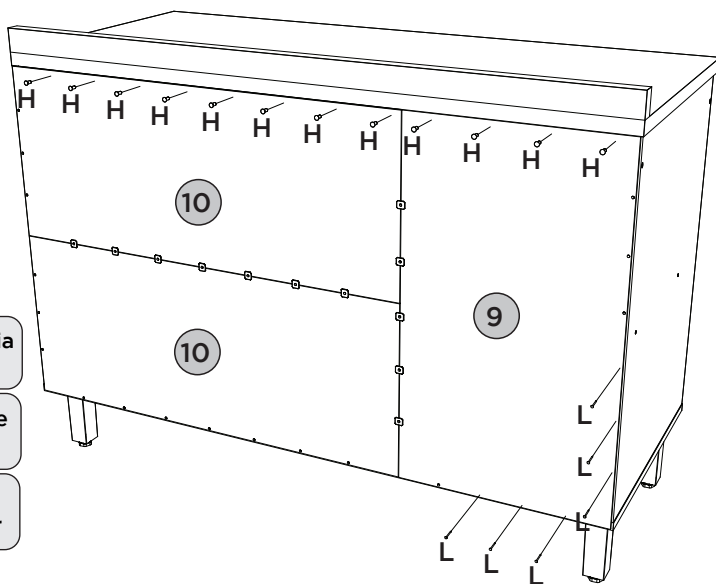

Fixar os pregos a uma distância de 100mm de um para outro.



Fijar las uñas a un distancia de 100mm uno a otro.

Fix the nails at a distance of 100mm from one to the other

PEÇAS REQUERIDAS

| | | |
|----|-------------|----|
| 11 | PORTA | x2 |
| 12 | PORTA MENOR | x1 |

ACESSÓRIOS REQUERIDOS

| | | |
|---|-----------------------------------------------------------------------------------|----|
| H |  | 12 |
| Q |  | 06 |

FERRAMENTAS NECESSÁRIAS

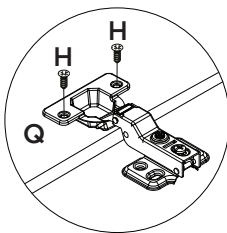
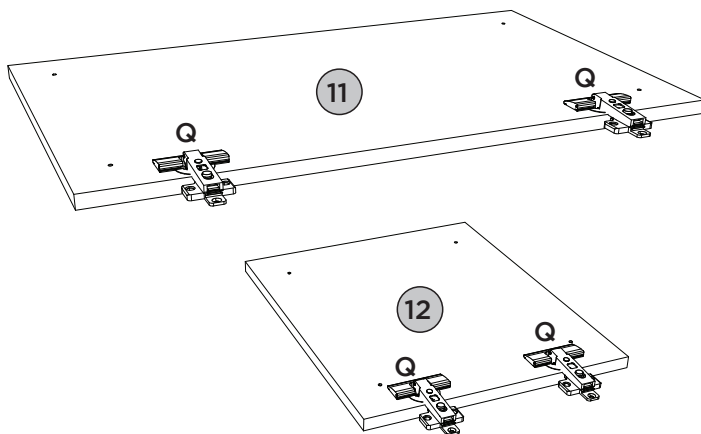
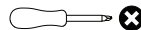



PASSO 8

ITM/C640-

PEÇAS REQUERIDAS

| | | |
|----|-------------|----|
| 11 | PORTA | x2 |
| 12 | PORTA MENOR | x1 |

ACESSÓRIOS REQUERIDOS

| | | |
|---|-----------------------------------------------------------------------------------|----|
| H |  | 24 |
| J |  | 06 |
| R |  | 03 |

FERRAMENTAS NECESSÁRIAS



Para porta (11 e 12): Defina para o modo de perfuração.
Faça a furação passante para fixar os puxadores (R).

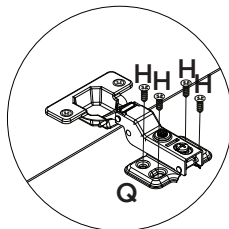
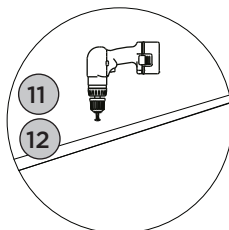
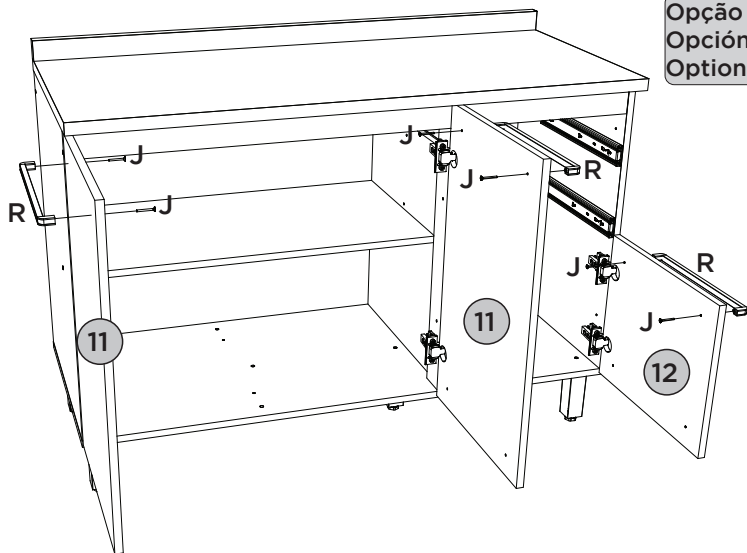

Opção 02
Opción 02
Option 02

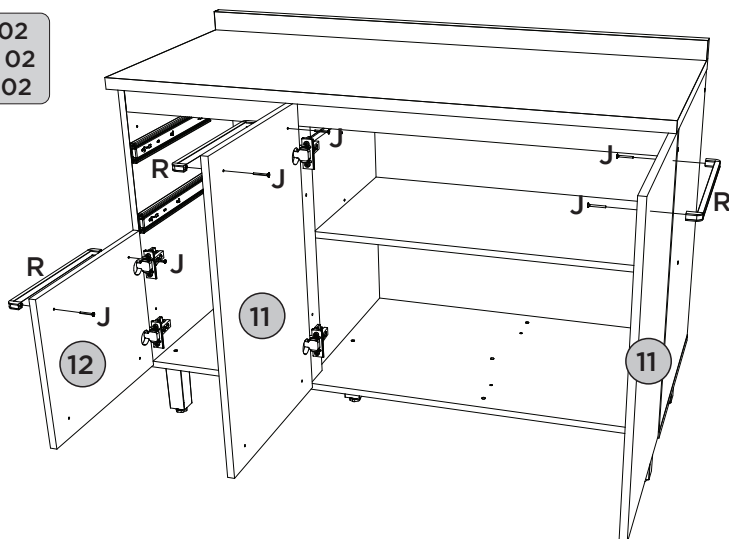





PASSO 9

ITM/C640-

PEÇAS REQUERIDAS

| | | |
|----|------------------|----|
| 13 | FRENTE DE GAVETA | x2 |
| 14 | LADO DE GAVETA | x4 |
| 15 | FUNDO DE GAVETA | x2 |

ACESSÓRIOS REQUERIDOS

| | | |
|---|-----------------------------------------------------------------------------------|----|
| H |  | 08 |
| K |  | 16 |
| N |  | 04 |
| W |  | |

FERRAMENTAS NECESSÁRIAS

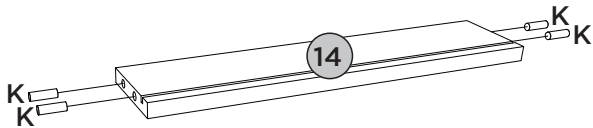
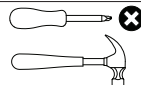

1º
2X

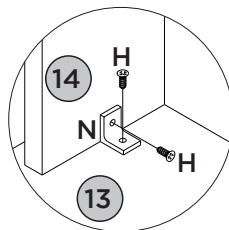
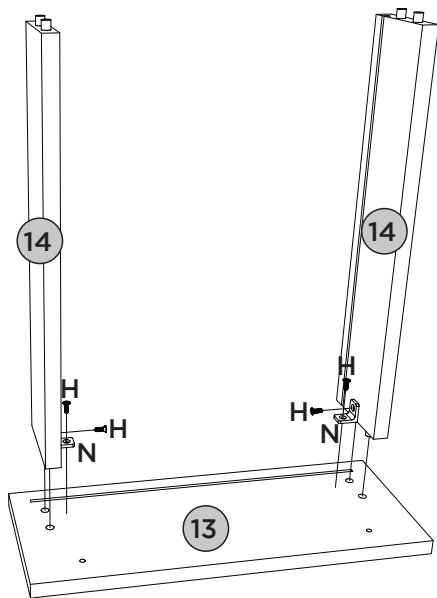

2º
2X

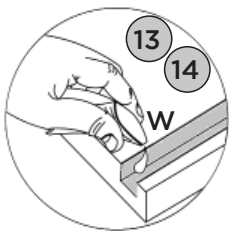
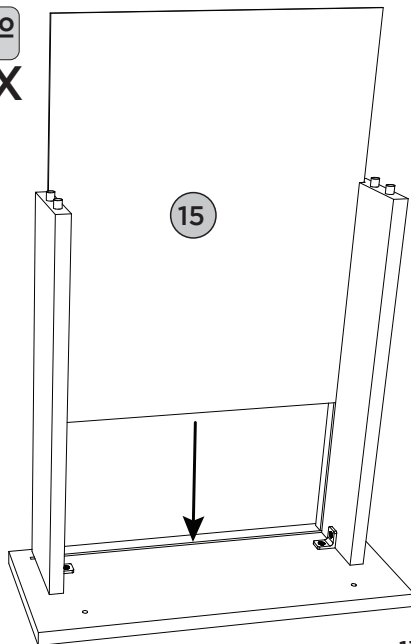

PASSO 10

ITM/C640-

PEÇAS REQUERIDAS

| | | |
|----|--------------|----|
| 16 | RIPA DE TRÁS | x2 |
|----|--------------|----|

ACESSÓRIOS REQUERIDOS

| | | |
|---|--|----|
| H | | 12 |
| I | | 04 |
| J | | 04 |
| R | | 02 |
| S | | 04 |
| W | | |

FERRAMENTAS NECESSÁRIAS

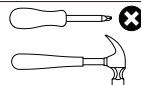

3º
2X

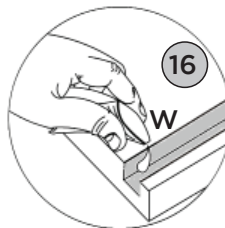
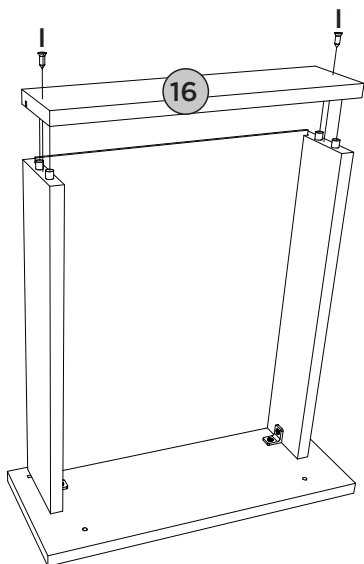

4º
2X

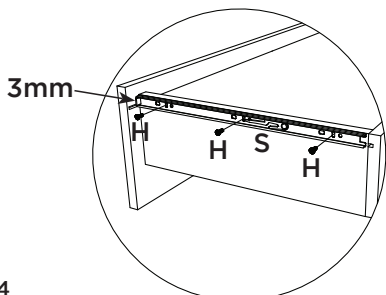
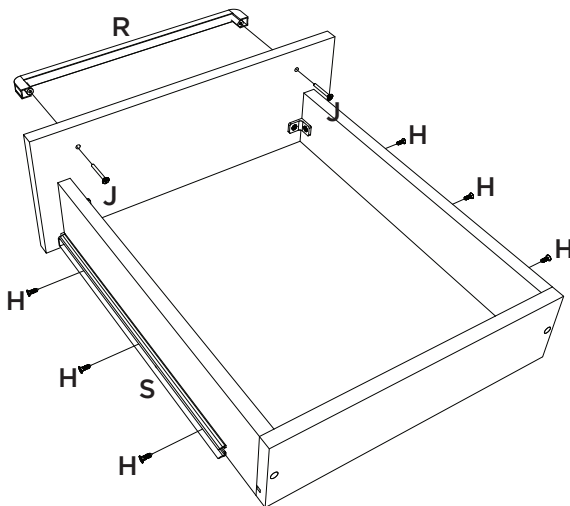

ACESSÓRIOS REQUERIDOS

| | | | | | |
|---|--|----|----|--|----|
| B | | 02 | X | | 06 |
| H | | 04 | Y | | 26 |
| O | | 02 | Z | | 03 |
| U | | 02 | AA | | 01 |
| V | | 02 | | | |

FERRAMENTAS NECESSÁRIAS



OU

Para parede: Ajustar no modo perfuração.
Para peça (02 e 07): Usar torque 5.

Pesos máximos recomendados com carga distribuída
Peso máximo recomendado con la carga distribuida
Recommended maximum weight with distributed load.

PERFECT CORRECTION
CORRECCIÓN PERFECTA

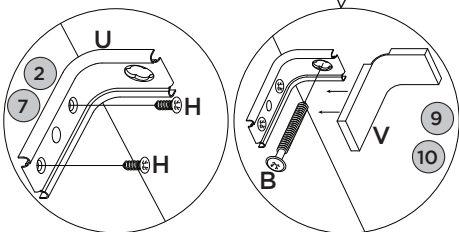
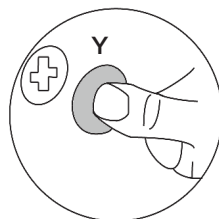
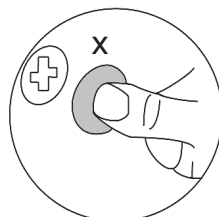
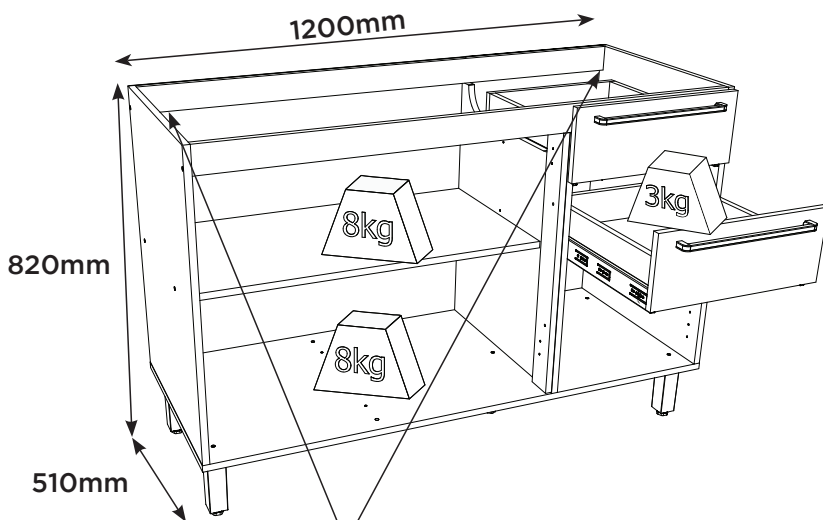
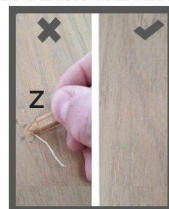

RECOMENDAÇÃO

Para fixar o móvel na parede usar o suporte de fixação (U), o parafuso 4,0x14mm CHT (H), a Bucha 8mm (O) e o parafuso 5,0x50mm FLA (B).

RECOMENDACIÓN

Para conectar el móvil a la pared con el soporte (U), tornillo 4,0 x14mm CHT (H), el casquillo de 8 mm (O) y el 5,0 x50mm tornillo FLA (B).

RECOMMENDATION

To fix the furniture to the wall use the fixing bracket (U), the 4,0x14mm CHT (H) screw, the 8mm bushing (O) and the 5.0x50mm FLA screw (B).

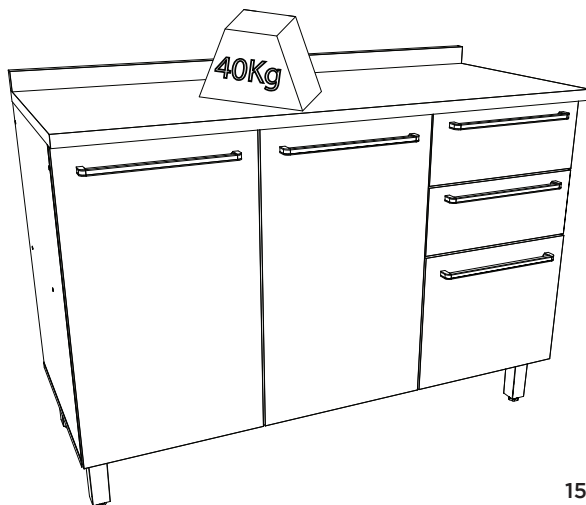

Producto Concluído
Producto terminado
Finished Product

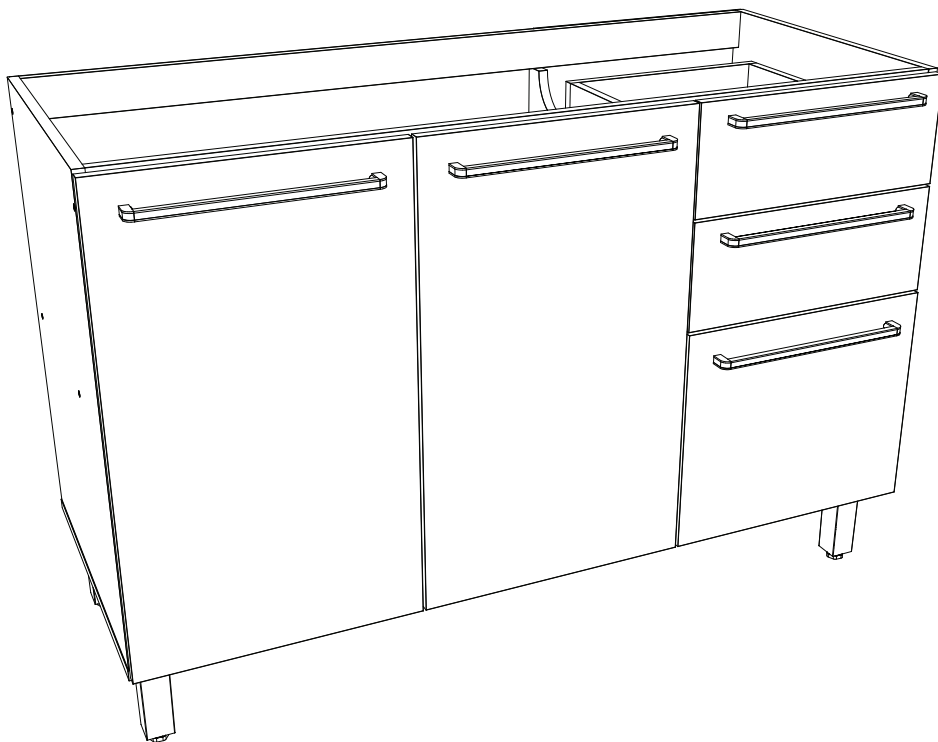



Ind. e Com. de Móveis Henn
Mondai - SC - Brasil

+55 49 3674.3500

@moveishenn
www.henn.com.br

INSTRUÇÕES DE MONTAGEM

INSTRUCCIONES DE MONTAJE
ASSEMBLY INSTRUCTIONS

Torre Quente 02 Fornos 715mm Requite |

Torre Caliente 02 Hornos 715mm Requite | Hot Tower 02 Ovens 715mm Requite

C643-217 Nature/Areia HP
C643-218 Nature/Nature/Areia HP

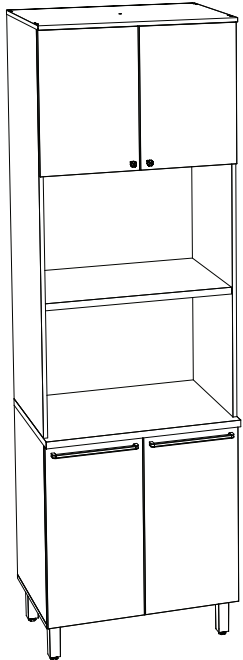

Requisitos para montagem
Requisitos para la montaje
Assembly Requirements

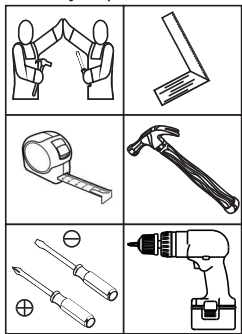

Imagens meramente ilustrativas, não acompanha o produto.
Imágenes ilustrativas, no incluidas con el producto.
Illustrative images, not included with the product.

AVISO

Para limpeza de seu móvel, use uma franela seca ou umedecida, e não utilize produtos químicos que possam danificar seu produto.

SISTEMA DE MONTAGEM

O sistema de montagem dos produtos, funciona de acordo com a ordem crescente dos números indicados no desenho. Ex: 01, 02, 03, 04... até a conclusão da montagem.

ASSISTÊNCIA TÉCNICA

Para solicitação de Assistência Técnica você consumidor deverá entrar em contato com o Lojista o qual você realizou a compra deste produto e solicitar a assistência técnica das peças avariadas. A garantia abrange todas as peças, partes e componentes que eventualmente venham apresentar defeito de fabricação no prazo de 03 (três) meses, contando a partir da entrega do produto ao consumidor, mediante nota fiscal de compra. Se houver qualquer alteração na estrutura do produto ou ocorrer defeito por negligência do montador/consumidor em relação a instrução de montagem e manuseio, não será fornecido assistência técnica gratuita.

ADVERTENCIA

Para limpieza de su móvil, use una franela seca o húmeda, y no utilice productos químicos que puedan dañar su producto.

SISTEMA DE MONTAJE

El sistema de montaje de los productos funciona de acuerdo con el orden creciente de los números indicados en el dibujo. Ej.: 01, 02, 03, 04... hasta la conclusión del montaje.

ASISTENCIA TÉCNICA

Para solicitar Asistencia Técnica, el consumidor debe comunicarse con el Comercio que usted realizó la compra de este producto y solicita asistencia técnica para las partes dañadas. La garantía cubre todas las partes, piezas y componentes que eventualmente puedan presentar defecto de fabricación en el plazo de 03 (tres) meses, contados a partir de la entrega del producto al consumidor, mediante factura de compra. Si se produce algún cambio en la estructura del producto o se produce un defecto por negligencia del montador/consumidor en relación con las instrucciones de montaje y manipulación, no se prestará asistencia técnica gratuita.

NOTICE

To clean your furniture, use a dry or wet cloth, and do not use chemicals that may damage your product.

ASSEMBLY SYSTEM

The products' assembly system works according to the increasing order of the indicated numbers. For example: 01, 02, 03, 04 ... to the end of the assembly.

TECHNICAL ASSISTANCE

To request Technical Assistance, the consumer must contact the retailer from whom you purchased this product and request technical assistance for the damaged parts. The warranty covers all parts, parts and components that may eventually present a manufacturing defect within a period of 03 (three) months, counting from the delivery of the product to the consumer, by means of a purchase invoice. If there is any change in the structure of the product or defect occurs due to negligence of the assembler/consumer in relation to the assembly and handling instruction, free technical assistance will not be provided.

ACESSÓRIOS | ACCESORIOS | ACCESSORIES

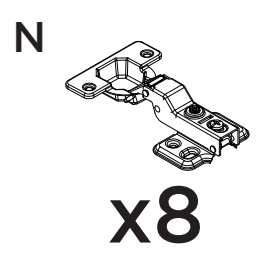
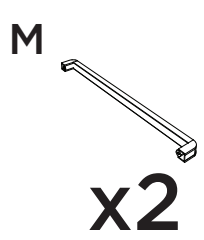
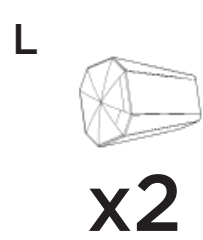
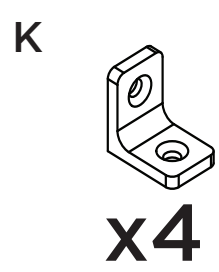
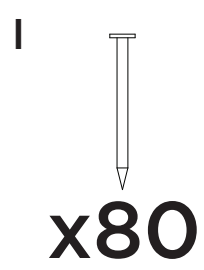
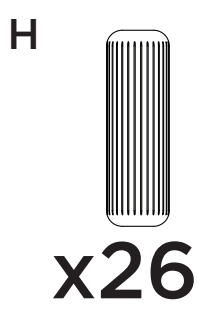
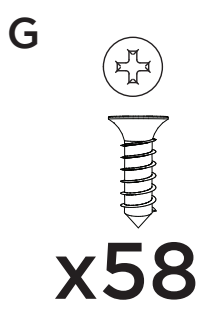
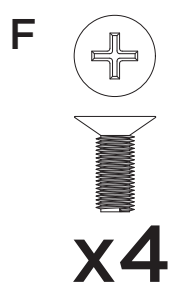
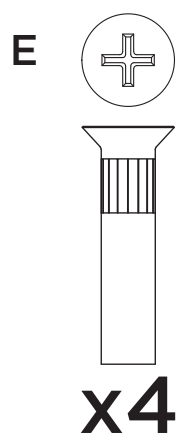
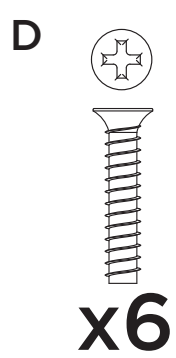
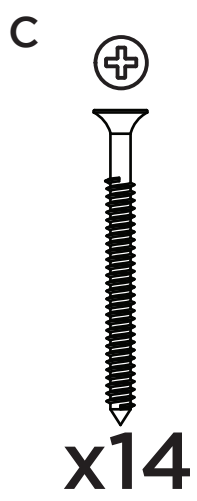
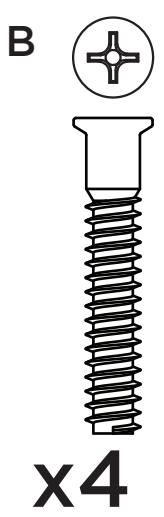
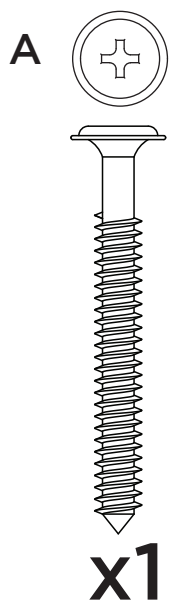

Parafusos em escala
Tornillos escalados
Scaled screws **1:1**

ACESSÓRIOS | ACCESORIOS | ACCESSORIES

O

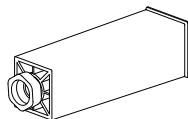

x4

P

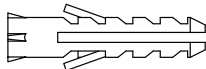

x1

Q

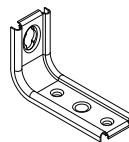

x1

R

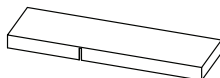

x1

S

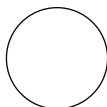

x16

T

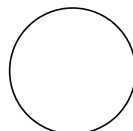

x12

U

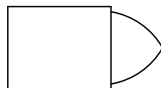

x3

V

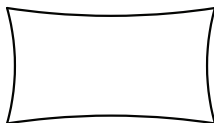

x1

W



x1

X



x4

Y

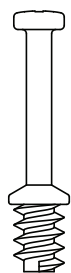

x8

Z



x8

Parafusos em escala
Tornillos escalados
Scaled screws 1:1



Os parafusos (E/F) devem ser usados somente quando este módulo for acoplado a outro módulo componível Henn.



Los tornillos (E/F) se debe utilizar sólo cuando el módulo está conectado a otro módulo componible Henn.



Screws (E/F) are to be used only when this module is mated to another Henn buildable module.

LISTA DE PEÇAS | LISTA DE PIEZAS | LIST OF PIECES

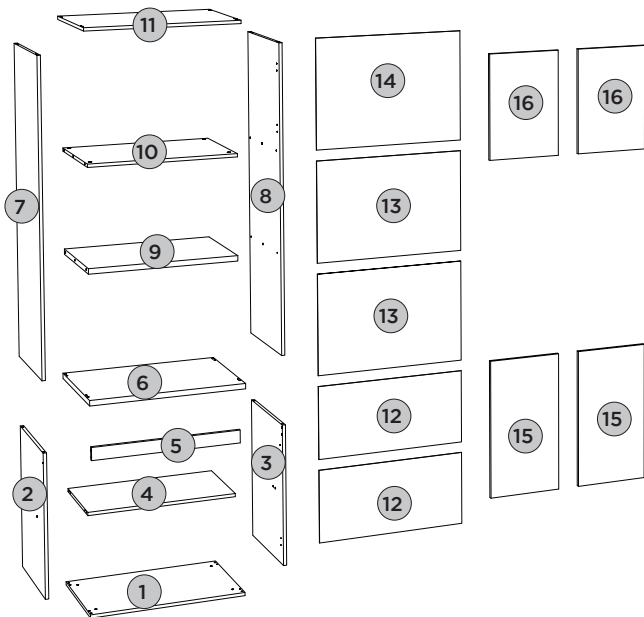

| Item | Caixa Caja Box | Qty Ctd Qty | Descrição Descripción Description | Dimensões (mm) Dimensiones (mm) | | |
|------|----------------------|-------------------|--------------------------------------------------------------------------|-----------------------------------|---------------------------|----------------------------------|
| | | | | Comprimento Largo Length | Largura Ancho Width | Espessura Grosor Thickness |
| 1 | 1/1 | 01 | BASE BASE BASE | 715 | 490 | 15 |
| 2 | 1/1 | 01 | LATERAL ESQUERDA INFERIOR LATERAL IZQUIERDA INFERIOR LEFT SIDE LOWER | 660 | 490 | 15 |
| 3 | 1/1 | 01 | LATERAL DIREITA INFERIOR LATERAL DERECHA INFERIOR RIGHT SIDE LOWER | 660 | 490 | 15 |
| 4 | 1/1 | 01 | PRATELEIRA ESTANTE SHELF | 684 | 400 | 15 |
| 5 | 1/1 | 01 | TRAVESSA FRONTAL TRAVESAÑO FRONTAL FRONT CROSS-BAR | 684 | 60 | 15 |
| 6 | 1/1 | 01 | TAMPO 25MM TAPA 25MM TOP 25MM | 715 | 533 | 25 |
| 7 | 1/1 | 01 | LATERAL ESQUERDA SUPERIOR LATERAL IZQUIERDA SUPERIOR UPPER LEFT SIDE | 1445 | 490 | 15 |
| 8 | 1/1 | 01 | LATERAL DIREITA SUPERIOR LATERAL DERECHA SUPERIOR UPPER RIGHT SIDE | 1445 | 490 | 15 |
| 9 | 1/1 | 01 | PRATELEIRA CENTRAL ESTANTE CENTRAL CENTRAL SHELF | 684 | 480 | 25 |
| 10 | 1/1 | 01 | BASE AÉREO BASE AEREO AIR BASE | 684 | 490 | 15 |
| 11 | 1/1 | 01 | TAMPO TAPA TOP | 715 | 517 | 15 |
| 12 | 1/1 | 02 | FUNDO INFERIOR FONDO INFERIOR LOWER BACKGROUND | 708 | 343 | 3 |
| 13 | 1/1 | 02 | FUNDO CENTRAL FONDO CENTRAL CENTRAL FUND | 708 | 475 | 3 |
| 14 | 1/1 | 01 | FUNDO SUPERIOR FONDO SUPERIOR UPPER BACKGROUND | 708 | 517 | 3 |
| 15 | 1/1 | 02 | PORTA INFERIOR PUERTA INFERIOR LOWER DOOR | 665 | 354 | 15 |
| 16 | 1/1 | 02 | PORTA PUERTA DOOR | 508 | 354 | 15 |





PASSO 1

ITM/C643-

PEÇAS REQUERIDAS

| | | |
|---|---------------------------|----|
| 1 | BASE | x1 |
| 2 | LATERAL ESQUERDA INFERIOR | x1 |
| 3 | LATERAL DIREITA INFERIOR | x1 |
| 4 | PRATELEIRA | x1 |
| 5 | TRAVESSA FRONTAL | x1 |

ACESSÓRIOS REQUERIDOS

| | | |
|---|-----------------------------------------------------------------------------------|----|
| B |  | 04 |
| H |  | 14 |
| O |  | 04 |
| V |  | |

FERRAMENTAS NECESSÁRIAS

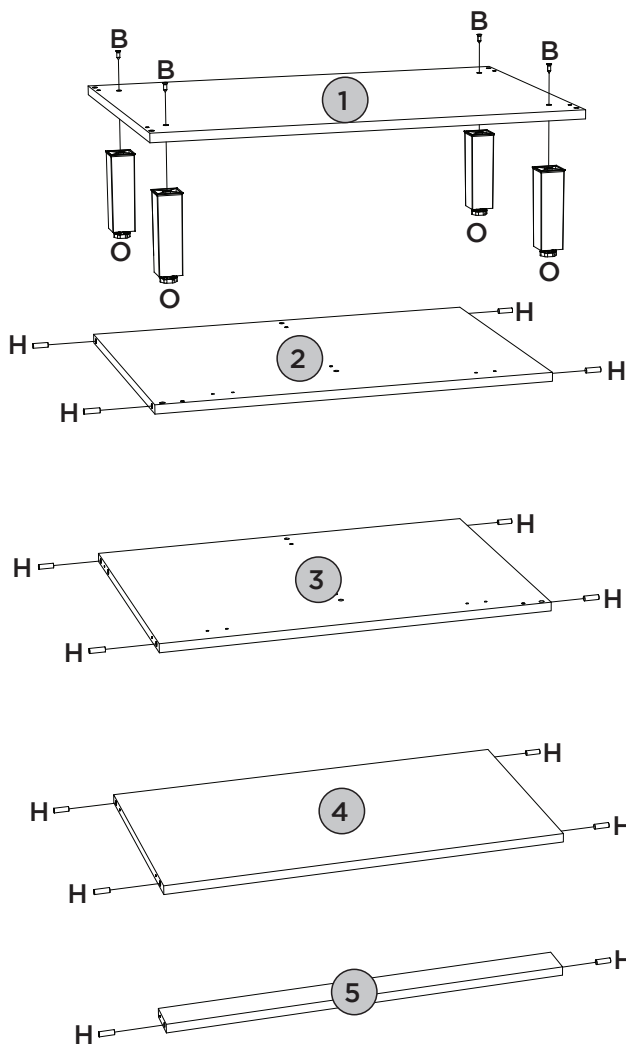
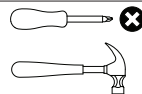

Utilizar o sachê de cola (V) em todas as cavilhas (H) do produto.

Con el pegamento sobre (V) en todos los pernos (H) do producto.

Use the glue sachet (V) on all the pegs (H) of the product.



PASSO 2

ITM/C643-

PEÇAS REQUERIDAS

| | | |
|----|---------------------------|----|
| 7 | LATERAL ESQUERDA SUPERIOR | x1 |
| 8 | LATERAL DIREITA SUPERIOR | x1 |
| 9 | PRATELEIRA CENTRAL | x1 |
| 10 | BASE AÉREO | x1 |

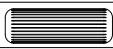
ACESSÓRIOS REQUERIDOS

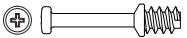
| | | |
|---|-----------------------------------------------------------------------------------|----|
| H |  | 12 |
| V |  | |
| Y |  | 08 |

FERRAMENTAS NECESSÁRIAS

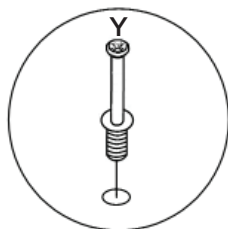
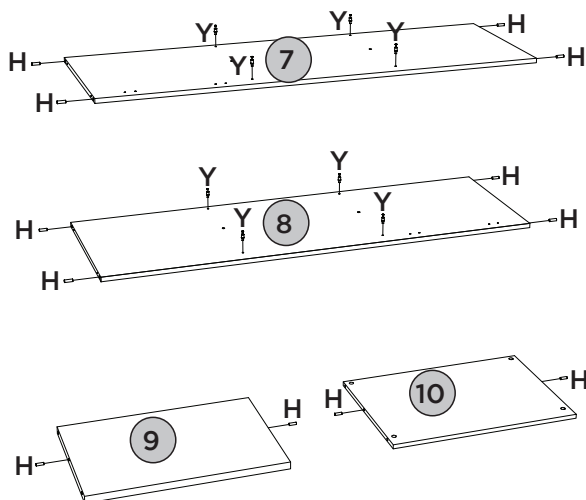
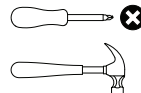



PASSO 3

PEÇAS REQUERIDAS

| | | |
|---|---------------------------|----|
| 1 | BASE | x1 |
| 2 | LATERAL ESQUERDA INFERIOR | x1 |
| 3 | LATERAL DIREITA INFERIOR | x1 |
| 4 | PRATELEIRA | x1 |
| 5 | TRAVESSA FRONTAL | x1 |

ACESSÓRIOS REQUERIDOS

| | | |
|---|-----------------------------------------------------------------------------------|----|
| C |  | 10 |
| V |  | |



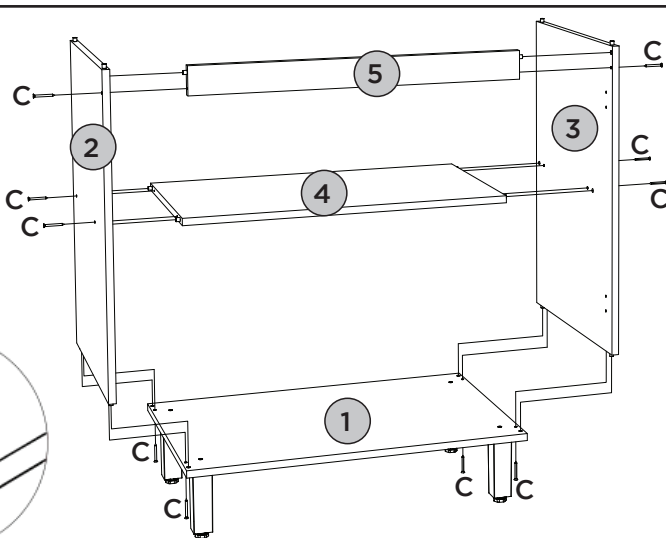
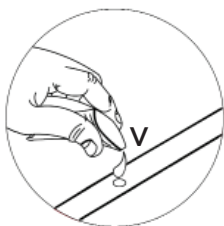
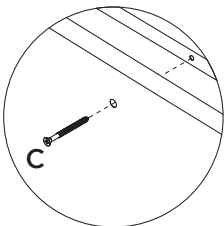
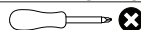

FERRAMENTAS NECESSÁRIAS



PEÇAS REQUERIDAS

| | | |
|----|---------------------------|----|
| 6 | TAMPO 25MM | x1 |
| 7 | LATERAL ESQUERDA SUPERIOR | x1 |
| 8 | LATERAL DIREITA SUPERIOR | x1 |
| 9 | PRATELEIRA CENTRAL | x1 |
| 10 | BASE AÉREO | x1 |
| 11 | TAMPO | x1 |

ACESSÓRIOS REQUERIDOS

| | | |
|---|-----------------------------------------------------------------------------------|----|
| C |  | 04 |
| V |  | |
| X |  | 04 |
| Z |  | 08 |

FERRAMENTAS NECESSÁRIAS

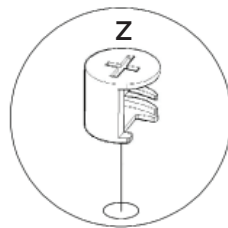
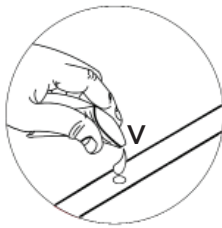
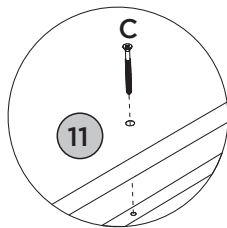
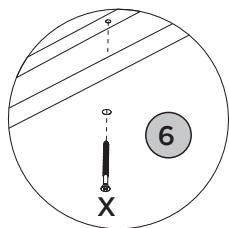
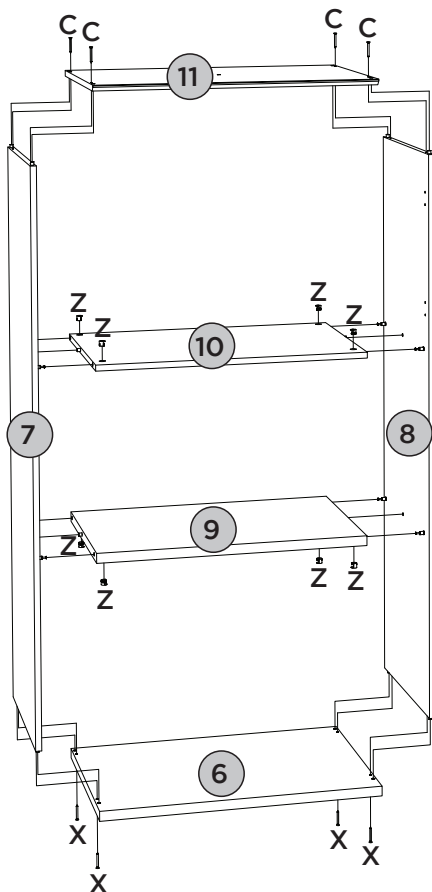

PASSO 5

ITM/C643-

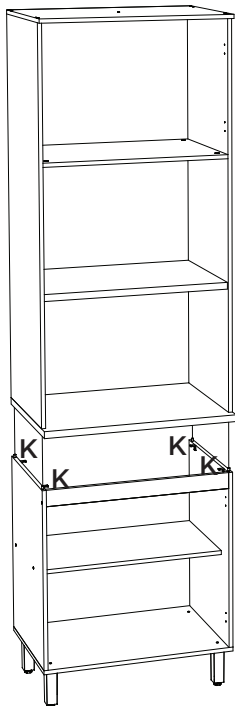

ACESSÓRIOS REQUERIDOS

| | | |
|---|--|----|
| G | | 08 |
| K | | 04 |
| V | | |

FERRAMENTAS NECESSÁRIAS

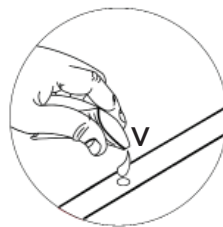
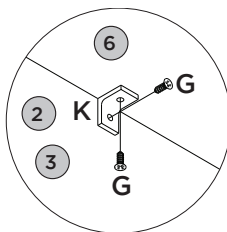
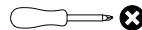

PASSO 6

PEÇAS REQUERIDAS

| | | |
|----|----------------|----|
| 12 | FUNDO INFERIOR | x2 |
| 13 | FUNDO CENTRAL | x2 |
| 14 | FUNDO SUPERIOR | x1 |

ACESSÓRIOS REQUERIDOS

| | | |
|---|--|----|
| I | | 80 |
| J | | 24 |

FERRAMENTAS NECESSÁRIAS

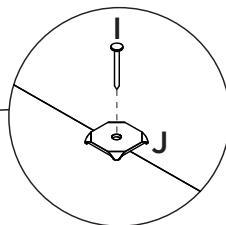
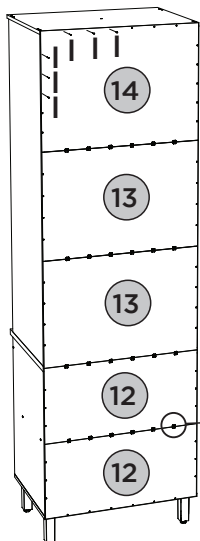
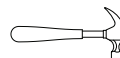

Fixar os pregos a uma distância de 100mm de um para outro.

Fijar las uñas a un distancia de 100mm uno a otro.

Fix the nails at a distance of 100mm from one to the other

PEÇAS REQUERIDAS

| | | |
|----|----------------|----|
| 15 | PORTA INFERIOR | x2 |
| 16 | PORTA | x2 |

ACESSÓRIOS REQUERIDOS

| | | |
|---|-----------------------------------------------------------------------------------|----|
| G |  | 16 |
| N |  | 08 |



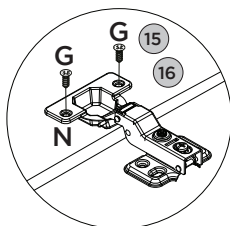
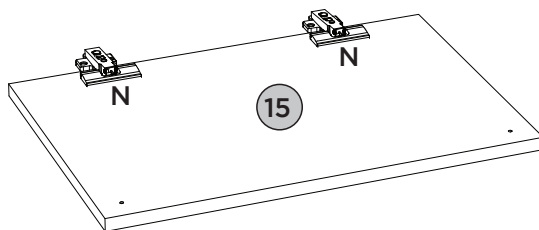
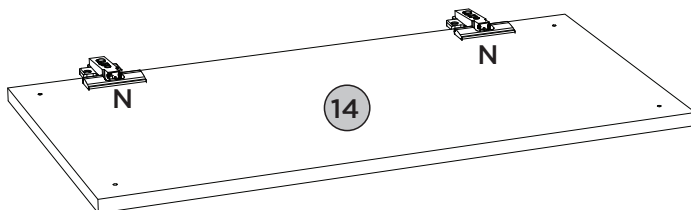
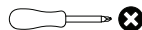



FERRAMENTAS NECESSÁRIAS



PEÇAS REQUERIDAS

| | | |
|----|----------------|----|
| 15 | PORTA INFERIOR | x2 |
| 16 | PORTA | x2 |

ACESSÓRIOS REQUERIDOS

| | | |
|---|---------------------------------------------------------------------------------------------------------------------------------------------------------------------|----|
| D |   | 06 |
| G |   | 32 |
| L |  | 02 |
| M |  | 02 |

FERRAMENTAS NECESSÁRIAS

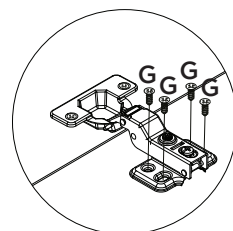
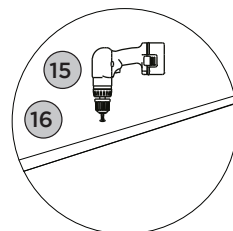
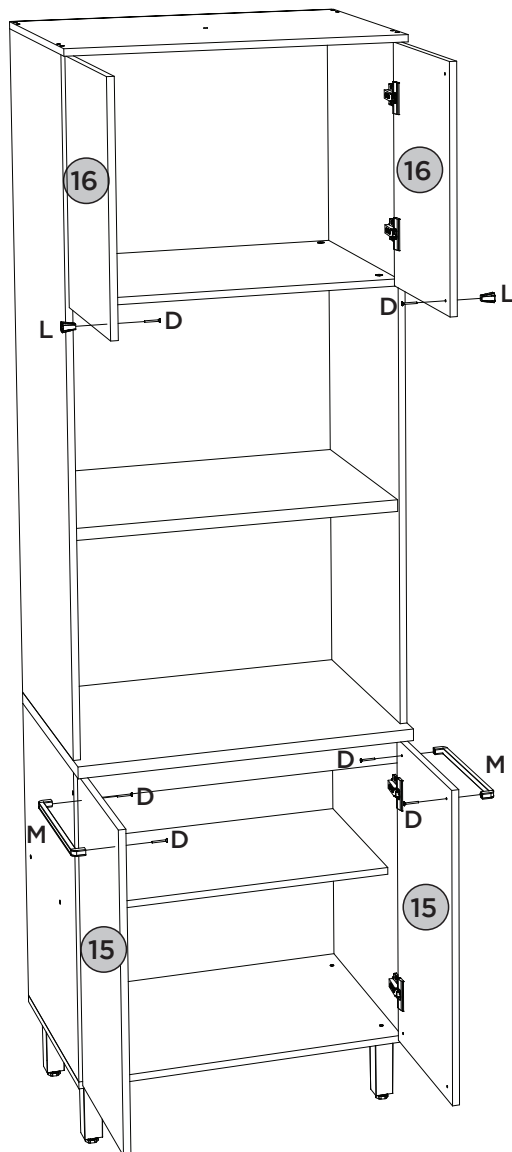
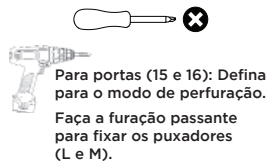

ACESSÓRIOS REQUERIDOS

| | | | | | |
|---|--|----|---|--|----|
| A | | 01 | S | | 16 |
| G | | 02 | T | | 12 |
| P | | 01 | U | | 03 |
| Q | | 01 | W | | 01 |
| R | | 01 | | | |

FERRAMENTAS NECESSÁRIAS

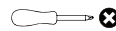

OU



Para parede: Ajustar no modo perfuração
Para peça (11): Usar torque 5

Pesos máximos recomendados com carga distribuída
Peso máximo recomendado con la carga distribuida
Recommended maximum weight with distributed load.

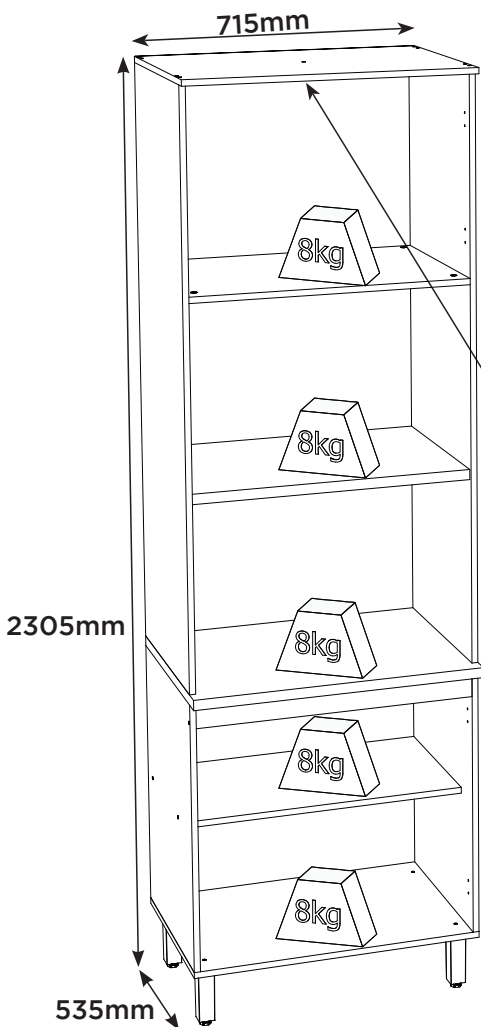

PERFECT CORRECTION
CORRECCIÓN PERFECTA

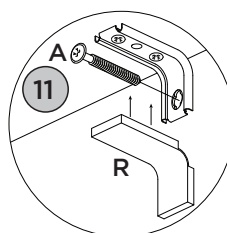
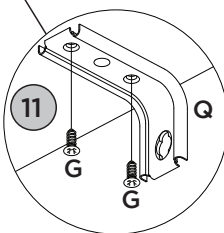
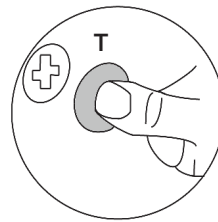
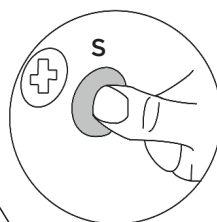
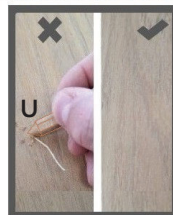

RECOMENDAÇÃO

Para fixar o móvel na parede usar o suporte de fixação (Q), o parafuso 4,0x14mm CHT (G), a Bucha 8mm (P) e o parafuso 5,0x50mm FLA (A).

RECOMENDACIÓN

Para conectar el móvil a la pared con el soporte (Q), tornillo 4,0x14mm CHT (G), el casquillo de 8 mm (P) y el 5,0 x50mm tornillo FLA (A).

RECOMMENDATION

To fix the furniture to the wall use the fixing bracket (Q), the 4,0x14mm CHT (G) screw, the 8mm bushing (P) and the 5.0x50mm FLA screw (A).

Produto Concluído
Producto terminado
Finished Product

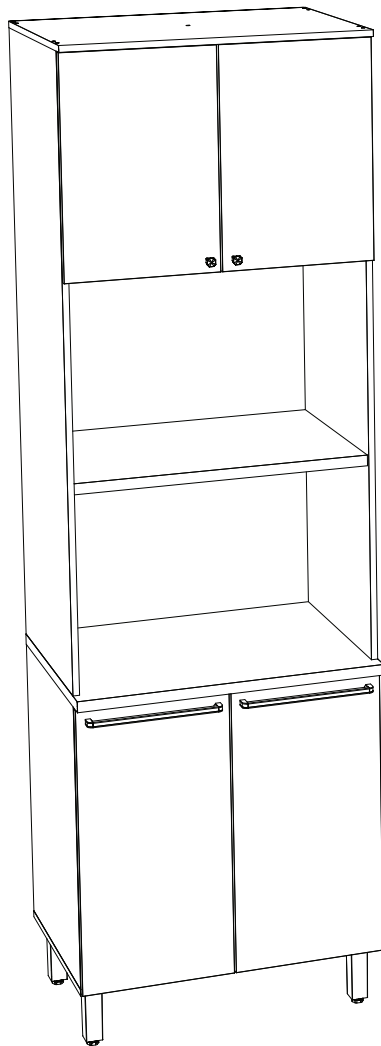

HENNInd. e Com. de Móveis Henn
Mondai - SC - Brasil

☎ +55 49 3674.3500

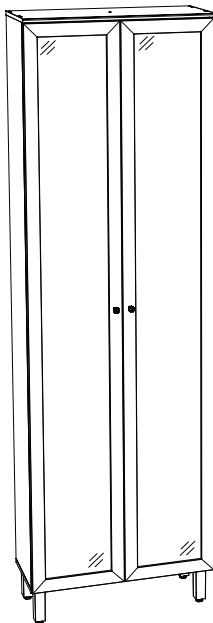
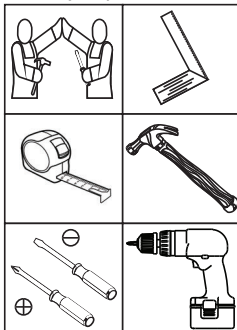
📱 @moveishenn
www.henn.com.br**INSTRUÇÕES DE
MONTAGEM**INSTRUCCIONES DE MONTAJE
ASSEMBLY INSTRUCTIONS**Cristaleira 02 Portas Requite |
Gabinete 02 Puertas Requite | Cabinet 02 Doors Requite****C645-128 Nature
C645-217 Nature/Areia HP****Requisitos para montagem
Requisitos para la montaje
Assembly Requirements**

Imagens meramente ilustrativas,
não acompanha o produto.
Imágenes ilustrativas, no incluidas
con el producto.
Illustrative images, not included
with the product.

AVISO

Para limpeza de seu móvel, use uma flanela seca ou umedecida, e não utilize produtos químicos que possam danificar seu produto.

SISTEMA DE MONTAGEM

O sistema de montagem dos produtos, funciona de acordo com a ordem crescente dos números indicados no desenho. Ex: 01, 02, 03, 04... até a conclusão da montagem.

ASSISTÊNCIA TÉCNICA

Para solicitação de Assistência Técnica você consumidor deverá entrar em contato com o Lojista a qual você realizou a compra deste produto e solicitar a assistência técnica das peças avariadas. A garantia abrange todas as peças, partes e componentes que eventualmente venham apresentar defeito de fabricação no prazo de 03 (três) meses, contando a partir da entrega do produto ao consumidor, mediante nota fiscal de compra. Se houver qualquer alteração na estrutura do produto ou ocorrer defeito por negligência do montador/consumidor em relação a instrução de montagem e manuseio, não será fornecido assistência técnica gratuita.

ADVERTENCIA

Para limpieza de su móvil, use una flanela seca o húmeda, y no utilice productos químicos que puedan dañar su producto.

SISTEMA DE MONTAJE

El sistema de montaje de los productos funciona de acuerdo con el orden creciente de los números indicados en el dibujo. Ej.: 01, 02, 03, 04... hasta la conclusión del montaje.

ASISTENCIA TÉCNICA

Para solicitar Asistencia Técnica, el consumidor debe comunicarse con el Comercio que usted realizó la compra de este producto y solicita asistencia técnica para las partes dañadas. La garantía cubre todas las partes, piezas y componentes que eventualmente puedan presentar defecto de fabricación en el plazo de 03 (tres) meses, contados a partir de la entrega del producto al consumidor, mediante factura de compra. Si se produce algún cambio en la estructura del producto o se produce un defecto por negligencia del montador/consumidor en relación con las instrucciones de montaje y manipulación, no se prestará asistencia técnica gratuita.

NOTICE

To clean your furniture, use a dry or wet cloth, and do not use chemicals that may damage your product.

ASSEMBLY SYSTEM

The products' assembly system works according to the increasing order of the indicated numbers. For example: 01, 02, 03, 04 ... to the end of the assembly.

TECHNICAL ASSISTANCE

To request Technical Assistance, the consumer must contact the retailer from whom you purchased this product and request technical assistance for the damaged parts. The warranty covers all parts, parts and components that may eventually present a manufacturing defect within a period of 03 (three) months, counting from the delivery of the product to the consumer, by means of a purchase invoice. If there is any change in the structure of the product or defect occurs due to negligence of the assembler/consumer in relation to the assembly and handling instruction, free technical assistance will not be provided.

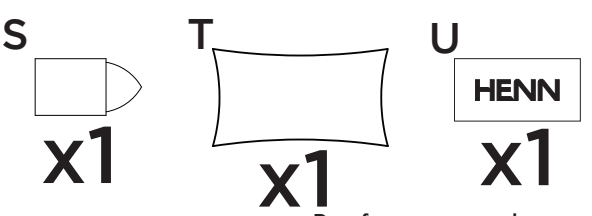
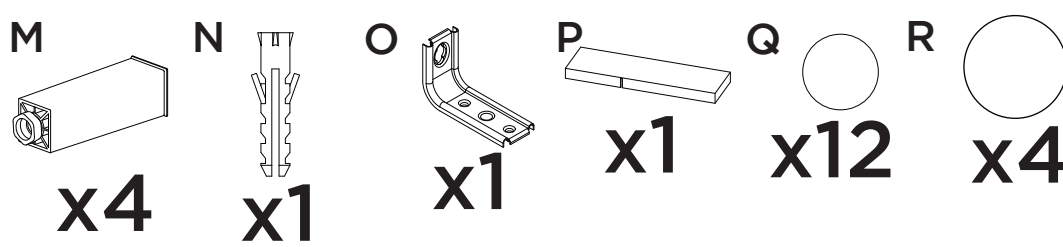
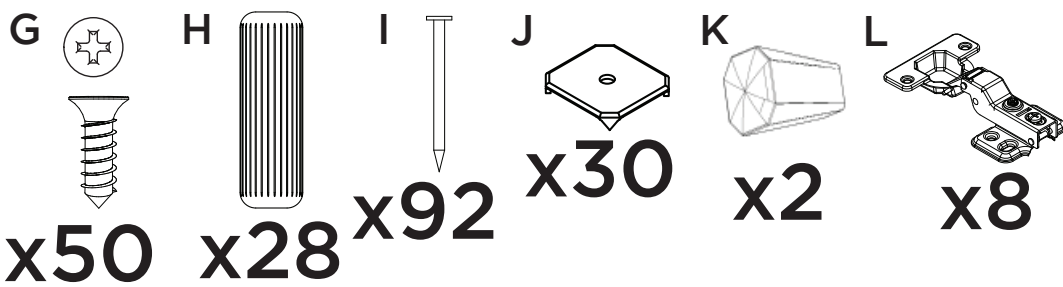
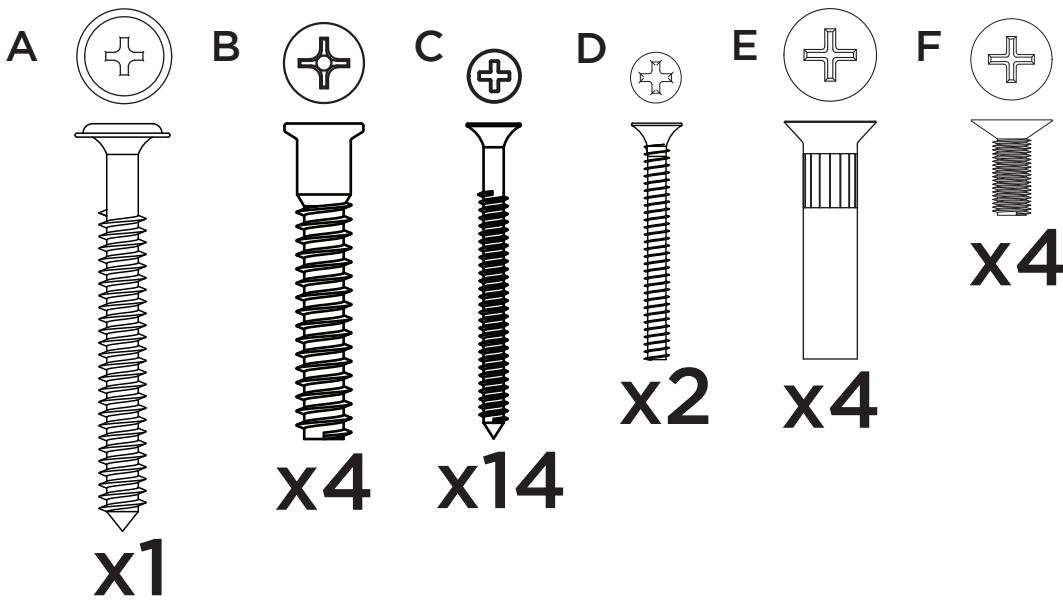

Parafusos em escada
Tornillos escalados
Scaled screws 1:1

Os parafusos (E/F) devem ser usados somente quando este módulo for acoplado a outro módulo componível Henn.

Los tornillos (E/F) se debe utilizar sólo cuando el módulo está conectado a otro módulo componible Henn.

Screws (E/F) are to be used only when this module is mated to another Henn buildable module.

LISTA DE PEÇAS | LISTA DE PIEZAS | LIST OF PIECES

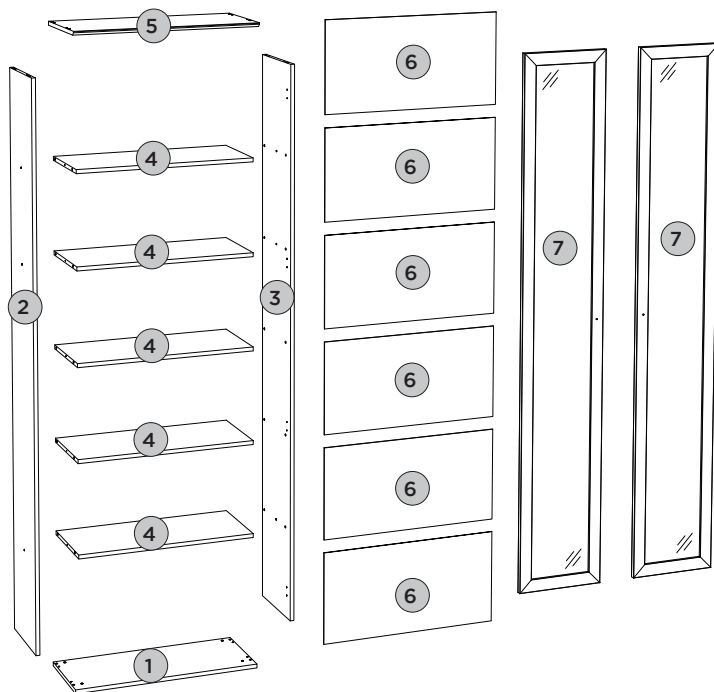





| Item | Caja Caja Box | Qty Ctd Qty | Descrição Descripción Description | Dimensões (mm) Dimensiones (mm) Dimensions (mm) | | |
|------|---------------------|-------------------|------------------------------------------------------------------------------------------------------------|--------------------------------------------------------|---------------------------|----------------------------------|
| | | | | Comprimento Largo Length | Largura Ancho Width | Espessura Grosor Thickness |
| 1 | 1/2 | 01 | BASE BASE BASE | 715 | 295 | 15 |
| 2 | 2/2 | 01 | LATERAL ESQUERDA LATERAL IZQUIERDA LEFT SIDE | 2130 | 295 | 15 |
| 3 | 2/2 | 01 | LATERAL DIREITA LATERAL DERECHA RIGHT SIDE | 2130 | 295 | 15 |
| 4 | 1/2 | 05 | PRATELEIRA ESTANTE SHELF | 684 | 295 | 15 |
| 5 | 1/2 | 01 | TAMPO TAPA TOP | 715 | 322 | 15 |
| 6 | 2/2 | 06 | FUNDO FONDO BOTTOM | 708 | 358 | 3 |
| 7 | 2/2 | 02 | PORTA DE VIDRO TEMPERADA REFLECTA PUERTA DE VIDRIO TEMPLADO REFLECTANTE REFLECT TEMPERED GLASS DOOR | 2137 | 354 | 15 |

PASSO 1

PEÇAS REQUERIDAS

| | | |
|---|------------------|----|
| 1 | BASE | x1 |
| 2 | LATERAL ESQUERDA | x1 |
| 3 | LATERAL DIREITA | x1 |
| 4 | PRATELEIRA | x5 |

ACESSÓRIOS REQUERIDOS

| | | |
|---|-----------------------------------------------------------------------------------|----|
| B |  | 04 |
| H |  | 28 |
| M |  | 04 |
| T |  | |

FERRAMENTAS NECESSÁRIAS

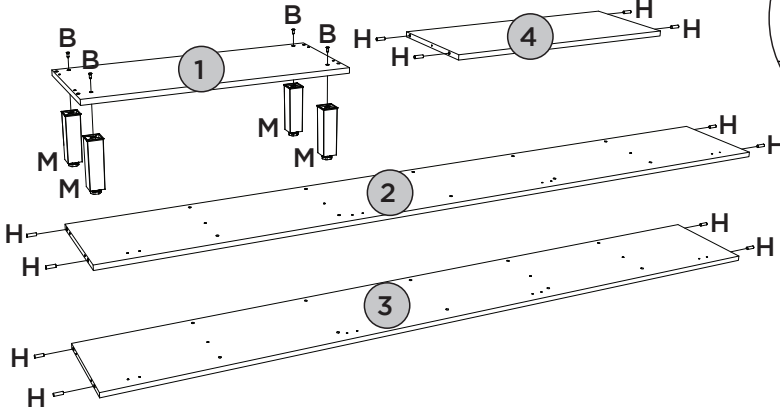
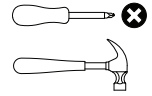

Utilizar o sachê de cola (T) em todas as cavilhas (H) do produto.

Con el pegamento sobre (T) en todos los pernos (H) producto.



Use the glue sachet (T) on all the pegs (H) of the product.

PASSO 2

PEÇAS REQUERIDAS

| | | |
|---|------------------|----|
| 1 | BASE | x1 |
| 2 | LATERAL ESQUERDA | x1 |
| 3 | LATERAL DIREITA | x1 |
| 4 | PRATELEIRA | x5 |
| 5 | TAMPO | x1 |

ACESSÓRIOS REQUERIDOS

| | | |
|---|-----------------------------------------------------------------------------------|----|
| C |  | 14 |
| T |  | |

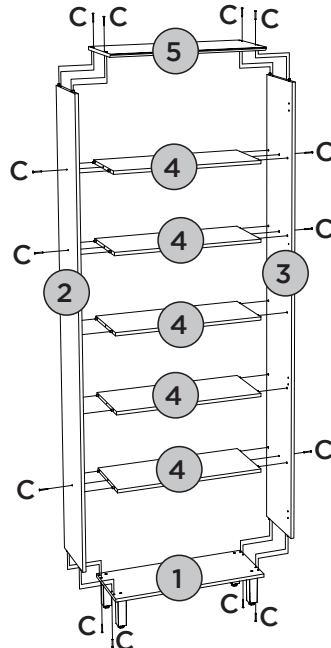
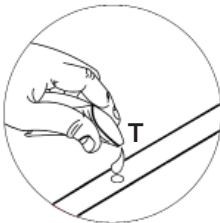
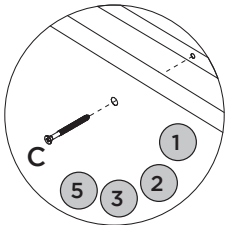

FERRAMENTAS NECESSÁRIAS



PEÇAS REQUERIDAS

| | | |
|---|-------|----|
| 6 | FUNDO | x6 |
|---|-------|----|

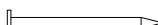
ACESSÓRIOS REQUERIDOS

| | | |
|---|-----------------------------------------------------------------------------------|----|
| I |  | 92 |
| J |  | 30 |

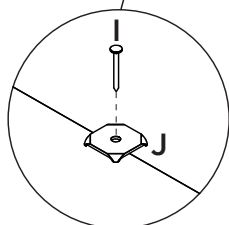
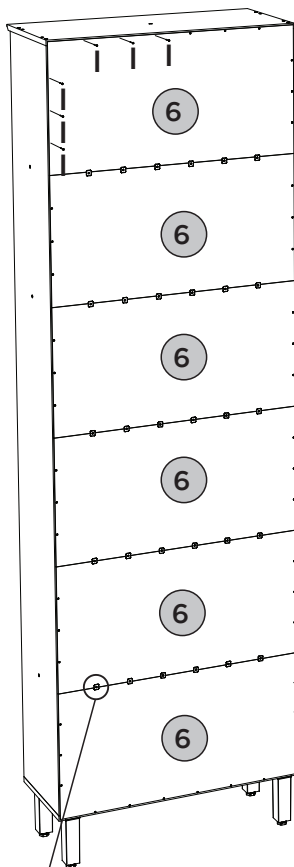
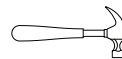
FERRAMENTAS NECESSÁRIAS

Fixar os pregos a uma distância de 100mm de um para outro.

Fijar las uñas a un distancia de 100mm uno a otro.

Fix the nails at a distance of 100mm from one to the other





PASSO 4

ITM/C645-

PEÇAS REQUERIDAS

| | | |
|---|--------------------------------------|----|
| 7 | PORTA DE VIDRO TEMPERADA REFLECTA | x2 |
|---|--------------------------------------|----|

ACESSÓRIOS REQUERIDOS

| | | |
|---|-----------------------------------------------------------------------------------|----|
| D |  | 02 |
| G |  | 16 |
| K |  | 02 |
| L |  | 08 |

FERRAMENTAS NECESSÁRIAS

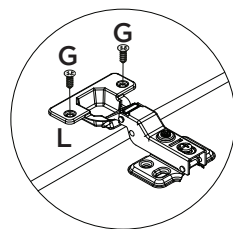
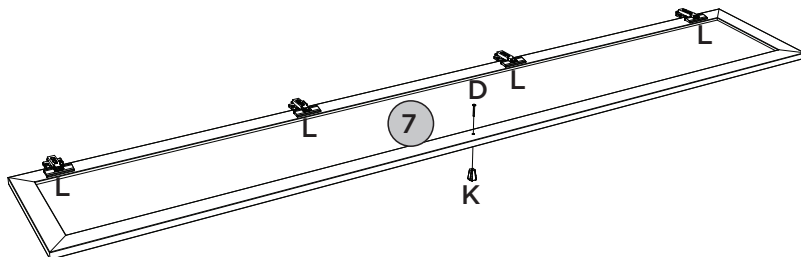
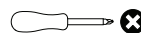

PASSO 5

PEÇAS REQUERIDAS

| | | |
|---|--------------------------------------|----|
| 7 | PORTA DE VIDRO TEMPERADA REFLECTA | x2 |
|---|--------------------------------------|----|

ACESSÓRIOS REQUERIDOS

| | | |
|---|-----------------------------------------------------------------------------------|----|
| G |  | 32 |
|---|-----------------------------------------------------------------------------------|----|

FERRAMENTAS NECESSÁRIAS

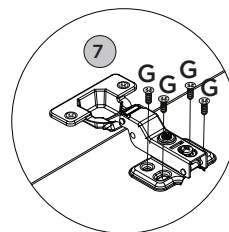
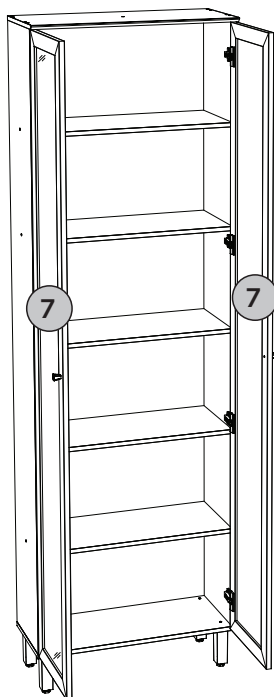
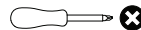

ACESSÓRIOS REQUERIDOS

| | | |
|---|--|----|
| A | | 01 |
| G | | 02 |
| N | | 01 |
| O | | 01 |
| P | | 01 |

| | | |
|---|--|----|
| Q | | 12 |
| R | | 04 |
| S | | 01 |
| U | | 01 |

FERRAMENTAS NECESSÁRIAS



Para parede: Ajustar no modo perfuração
Para peça (5): Usar torque 5

Pesos máximos recomendados com carga distribuída
Peso máximo recomendado con la carga distribuida
Recommended maximum weight with distributed load.

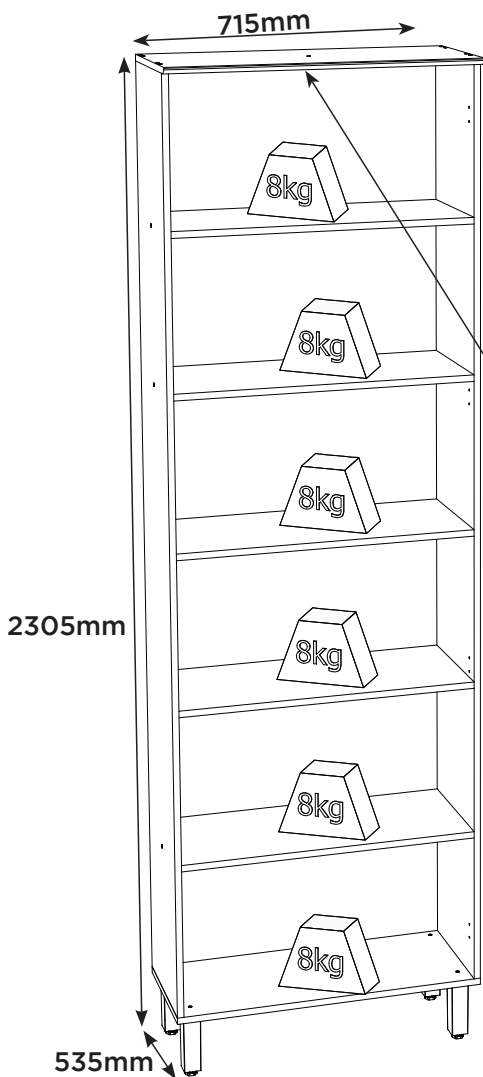

PERFECT CORRECTION
CORRECCIÓN PERFECTA

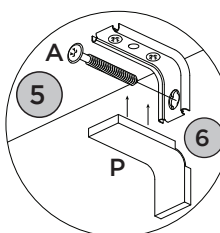
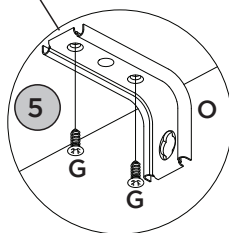
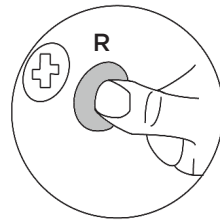
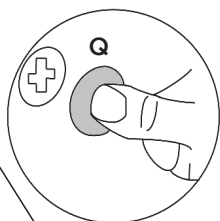
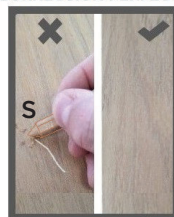

RECOMENDAÇÃO

Para fixar o móvel na parede usar o suporte de fixação (O), o parafuso 4,0x14mm CHT (G), a Bucha 8mm (N) e o parafuso 5,0x50mm FLA (A).

RECOMENDACIÓN

Para conectar el móvil a la pared con el soporte (O), tornillo 4,0x14mm CHT (G), el casquillo de 8 mm (N) y el 5,0 x50mm tornillo FLA (A).

RECOMMENDATION

To fix the furniture to the wall use the fixing bracket (O), the 4,0x14mm CHT (G) screw, the 8mm bushing (N) and the 5.0x50mm FLA screw (A).

Produto Concluído
Producto terminado
Finished Product

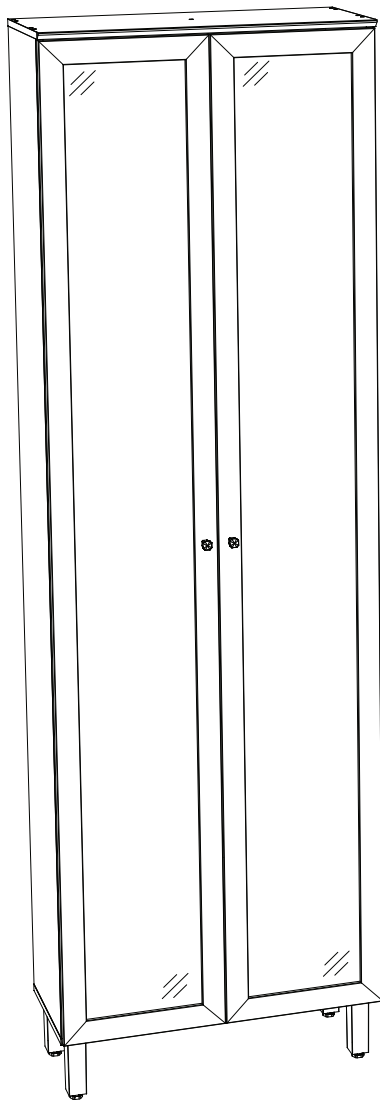

HENNInd. e Com. de Móveis Henn
Mondai - SC - Brasil

☎+55 49 3674.3500

📧@moveishenn
www.henn.com.br**INSTRUÇÕES DE MONTAGEM**INSTRUCCIONES DE MONTAJE
ASSEMBLY INSTRUCTIONS**Tampo para Balcão 1200mm | Tablero para Balcón 1200mm | Counter Top 1200mm**

- C905-23 Duna
- C905-33 Nero
- C905-90 Grafite HP
- C905-94 Rústico
- C905-114 Calcare

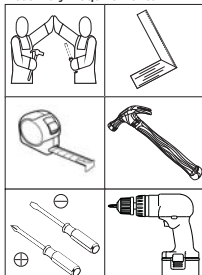
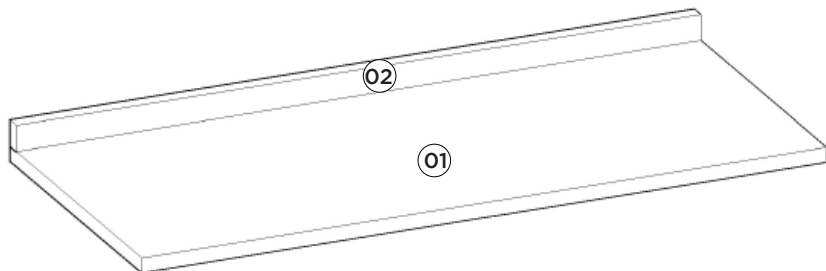
Requisitos para montagem
Requisitor para la montaje
Assembly RequirementsImagens meramente ilustrativas
Imágenes meramente ilustrativas
Images for illustration only**AVISO**

Para limpeza de seu móvel, use uma flanela seca ou umedecida, e não utilize produtos químicos que possam danificar seu produto.

SISTEMA DE MONTAGEM

O sistema de montagem dos produtos, funciona de acordo com a ordem crescente dos números indicados no desenho. Ex: 01, 02, 03, 04... até a conclusão da montagem.

ADVERTENCIA

Para limpieza de su móvil, use una franela seca o húmeda, y no utilice productos químicos que puedan dañar su producto.

Lista de Peças | Lista de piezas | List of parts

| Item | Caixa Caja Box | Qtd Ctd Qty | Descrição Descripción Description | Medidas (mm) Dimensions (mm) Size (measure- ments) (mm) |
|------|----------------------|-------------------|---------------------------------------------|----------------------------------------------------------------------|
| 01 | 1/1 | 01 | Tampo Tapa Top | 1200x533x25 |
| 02 | 1/1 | 01 | Rodatampo Rodatampo Rodatampo | 1200x45x25 |

SISTEMA DE MONTAJE

El sistema de montaje de los productos funciona de acuerdo con el orden creciente de los números indicados en el dibujo. Ej.: 01, 02, 03, 04... hasta la conclusión del montaje.

NOTICE

To clean your furniture, use a dry or wet cloth, and do not use chemicals that may damage your product.

Ferragens | Herrajes | Hardware

| | | | | | |
|------------------------------------------------------------------------------------|-----|-------------------------------------------------------------------------------------|-----|-------------------------------------------------------------------------------------|-----|
| A | 04x | B | 12x | C | 06x |
|  | |  | |  | |
| Parafuso 4,5x50mm CHT. Tornillo 4,5x50mm CHT. Screw 4,5x50mm CHT. | | Parafuso 3,5x14mm FLA. Tornillo 3,5x14mm FLA. Screw 3,5x14mm FLA. | | Cantoneira plástica Cantонера plástica Plastic angle brackets | |

ASSEMBLY SYSTEM

The products' assembly system works according to the increasing order of the indicated numbers. For example: 01, 02, 03, 04 ... to the end of the assembly.



Estas ferragens constam no Pacote do respectivo Balcão.
Estos herrajes constan en el Paquete del respectivo Balcón.
These hardware are included in the Package of the respective Counter.

Esse tampo é opcional e é vendido separadamente

Esta vez es opcional y se vende por separado

This top is optional and is sold separately

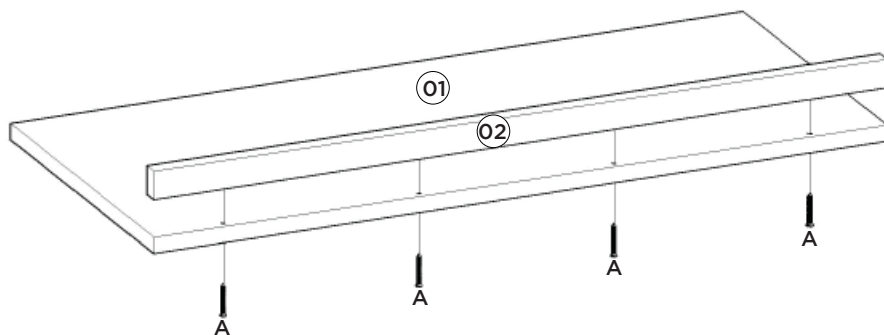

Exemplo de como fixar o Tampo no produto.

Ejemplo de la fijación de la tapa sobre el producto.

Example of fixing the lid on the product.

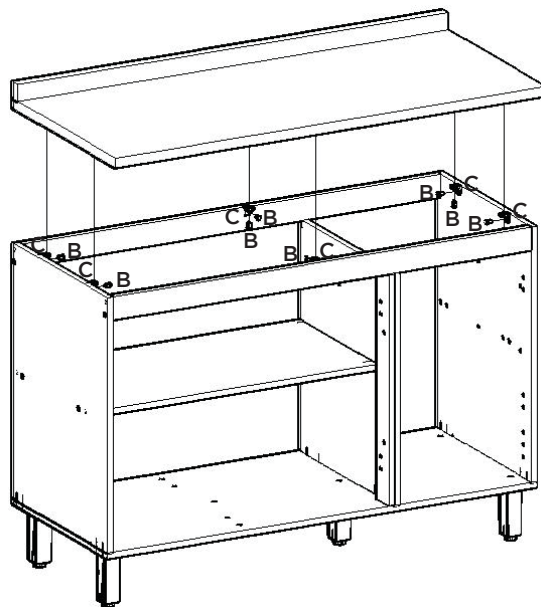

HENNInd. e Com. de Móveis Henn
Mondai - SC - Brasil

☎+55 49 3674.3500

📧@moveishenn
www.henn.com.br**INSTRUÇÕES DE MONTAGEM**INSTRUCCIONES DE MONTAJE
ASSEMBLY INSTRUCTIONS**Tampo Cooktop 800mm | Tampo Cooktop 800mm | Cooktop top 800mm**

- C908-23 Duna
- C908-33 Nero
- C908-114 Calcare

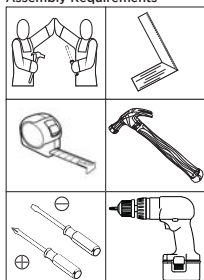
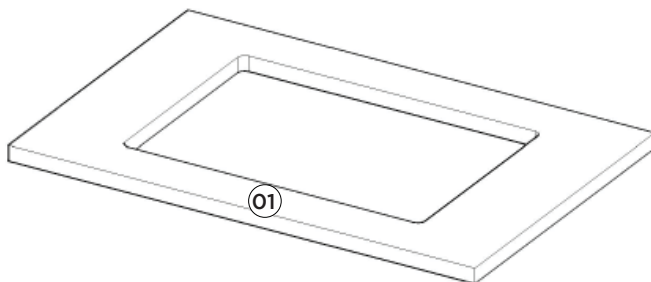
Requisitos para montagem
Requisitor para la montaje
Assembly RequirementsImagens meramente ilustrativas
Imágenes meramente ilustrativas
Images for illustration only**AVISO**

Para limpeza de seu móvel, use uma flanela seca ou umedecida, e não utilize produtos químicos que possam danificar seu produto.

SISTEMA DE MONTAGEM

O sistema de montagem dos produtos, funciona de acordo com a ordem crescente dos números indicados no desenho. Ex: 01, 02, 03, 04... até a conclusão da montagem.

ADVERTENCIA

Para limpieza de su móvil, use una franela seca o húmeda, y no utilice productos químicos que puedan dañar su producto.

SISTEMA DE MONTAJE

El sistema de montaje de los productos funciona de acuerdo con el orden creciente de los números indicados en el dibujo. Ej.: 01, 02, 03, 04... hasta la conclusión del montaje.

NOTICE

To clean your furniture, use a dry or wet cloth, and do not use chemicals that may damage your product.



ASSEMBLY SYSTEM

The products' assembly system works according to the increasing order of the indicated numbers. For example: 01, 02, 03, 04 ... to the end of the assembly.

Lista de Peças | Lista de piezas | List of parts

| Item | Caixa Caja Box | Qty Ctd Qty | Descrição Descripción Description | Medidas (mm) Dimensions (mm) Size (measure- ments) (mm) |
|------|----------------------|-------------------|---------------------------------------------|----------------------------------------------------------------------|
| 01 | 1/1 | 01 | Tampo Tapa Top | 800x533x25 |

Ferragens | Herrajes | Hardware

| | | | | | |
|-------------------------------------------------------------------------|------------------------------------------------------------------------------------|-----|---------------------------------------------------------------------|-------------------------------------------------------------------------------------|-----|
| A |  | 08x | B |  | 04x |
| Parafuso 3,5x14mm FLA. Tornillo 3,5x14mm FLA. Screw 3,5x14mm FLA. | | | Cantoneira plástica Cantонера plástica Plastic angle brackets | | |

 Estas ferragens constam no Pacote do respectivo Balcão.
Estos herrajes constan en el Paquete del respectivo Balcón.
These hardware are included in the Package of the respective Counter.

Esse tampo é opcional e é vendido separadamente

Esta vez es opcional y se vende por separado

This top is optional and is sold separately

Exemplo de como fixar o Tampo Cooktop no produto.

Ejemplo de cómo fijar el Tablero Cooktop en el producto.

Example of how to secure the Cooktop Top to the product.

