

**HENN**Ind. e Com. de Móveis Henn  
Mondai - SC - Brasil

☎ +55 49 3674.3500

📱 @moveishenn  
www.henn.com.br**INSTRUÇÕES DE  
MONTAGEM**INSTRUCCIONES DE MONTAJE  
ASSEMBLY INSTRUCTIONS**Aéreo 02 Porta Basculante 1200mm Requite | Aéreo 02  
Puerta Abatible 1200mm Requite |  
Aerial 02 Tipper Door 1200mm Requite**

C631-128 Nature

C631-217 Nature/Areia HP

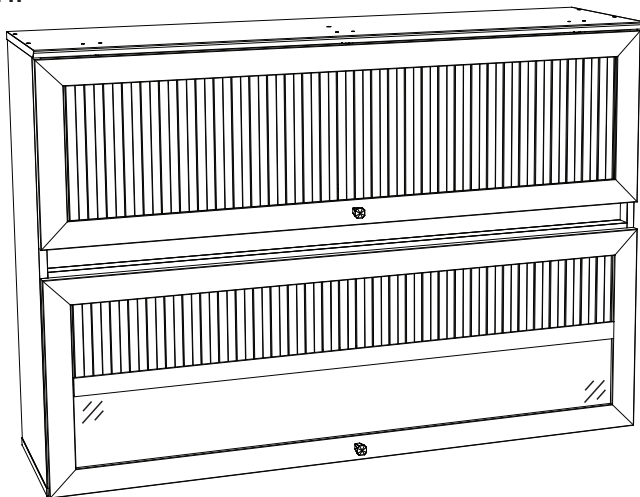
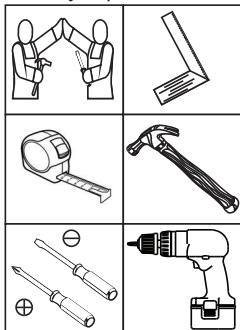
Requisitos para montagem  
Requisitos para la montaje  
Assembly RequirementsImagens meramente ilustrativas,  
não acompanha o produto.  
Imágenes ilustrativas, no incluidas  
con el producto.  
Illustrative images, not included  
with the product.**AVISO**

Para limpeza de seu móvel, use uma flanela seca ou umedecida, e não utilize produtos químicos que possam danificar seu produto.

**SISTEMA DE MONTAGEM**

O sistema de montagem dos produtos, funciona de acordo com a ordem crescente dos números indicados no desenho. Ex: 01, 02, 03, 04... até a conclusão da montagem.

**ASSISTÊNCIA TÉCNICA**

Para solicitação de Assistência Técnica você consumidor deverá entrar em contato com o Lojista o qual você realizou a compra deste produto e solicitar a assistência técnica das peças avariadas. A garantia abrange todas as peças, partes e componentes que eventualmente venham apresentar defeito de fabricação no prazo de 03 (três) meses, contando a partir da entrega do produto ao consumidor, mediante nota fiscal de compra. Se houver qualquer alteração na estrutura do produto ou ocorrer defeito por negligência do montador/consumidor em relação a instrução de montagem e manuseio, não será fornecido assistência técnica gratuita.

**ADVERTENCIA**

Para limpieza de su móvil, use una flanela seca o húmeda, y no utilice productos químicos que puedan dañar su producto.

**SISTEMA DE MONTAJE**

El sistema de montaje de los productos funciona de acuerdo con el orden creciente de los números indicados en el dibujo. Ej.: 01, 02, 03, 04... hasta la conclusión del montaje.

**ASISTENCIA TÉCNICA**

Para solicitar Asistencia Técnica, el consumidor debe comunicarse con el Comercio que usted realizó la compra de este producto y solicita asistencia técnica para las partes dañadas. La garantía cubre todas las partes, piezas y componentes que eventualmente puedan presentar defecto de fabricación en el plazo de 03 (tres) meses, contados a partir de la entrega del producto al consumidor, mediante factura de compra. Si se produce algún cambio en la estructura del producto o se produce un defecto por negligencia del montador/consumidor en relación con las instrucciones de montaje y manipulación, no se prestará asistencia técnica gratuita.

**NOTICE**

To clean your furniture, use a dry or wet cloth, and do not use chemicals that may damage your product.

**ASSEMBLY SYSTEM**

The products' assembly system works according to the increasing order of the indicated numbers. For example: 01, 02, 03, 04 ... to the end of the assembly.

**TECHNICAL ASSISTANCE**

To request Technical Assistance, the consumer must contact the retailer from whom you purchased this product and request technical assistance for the damaged parts. The warranty covers all parts, parts and components that may eventually present a manufacturing defect within a period of 03 (three) months, counting from the delivery of the product to the consumer, by means of a purchase invoice. If there is any change in the structure of the product or defect occurs due to negligence of the assembler/consumer in relation to the assembly and handling instruction, free technical assistance will not be provided.

## ACESSÓRIOS | ACCESORIOS | ACCESSORIES

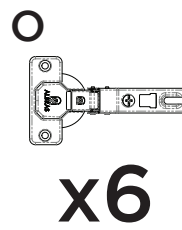
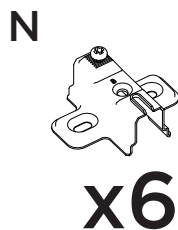
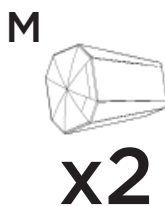
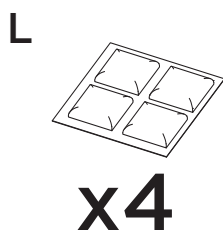
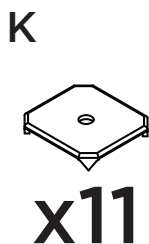
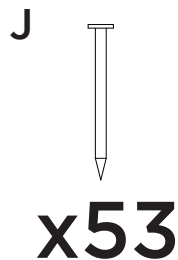
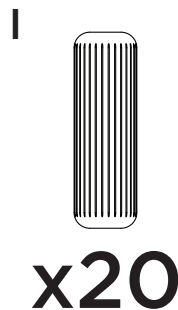
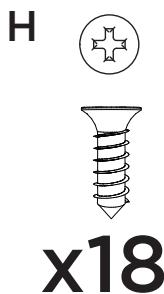
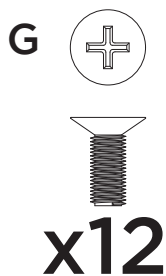
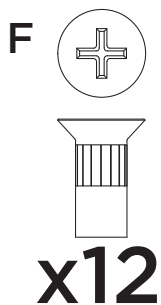
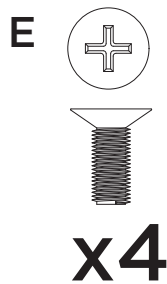
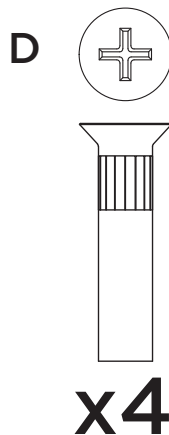
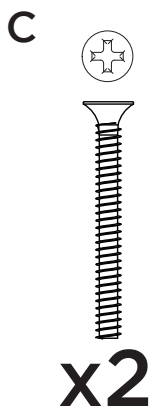
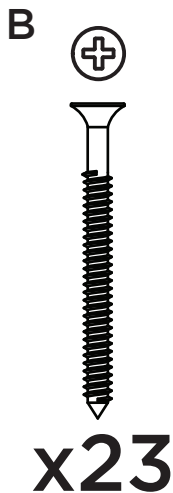
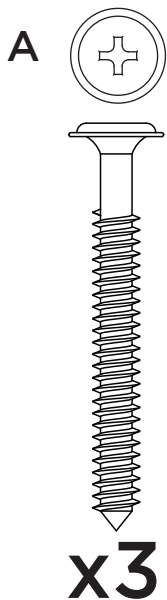

Parafusos em escala  
Tornillos escalados  
Scaled screws

**1:1**

# ACESSÓRIOS | ACCESORIOS | ACCESSORIES

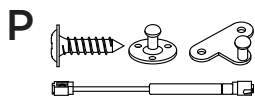

**x4** KIT

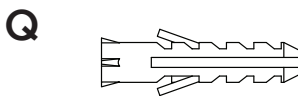

**x3**

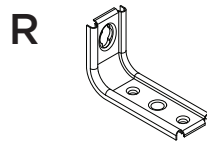

**x3**

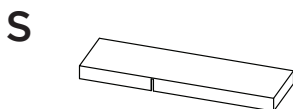

**x3**

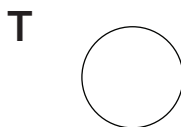

**x26**

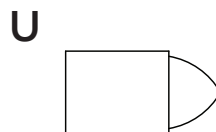

**x2**

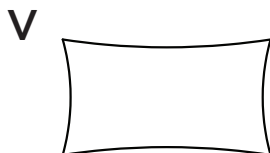

**x2**



**x1**



Os parafusos (D/E) devem ser usados somente quando este módulo for acoplado a outro módulo componível Henn.



Los tornillos (D/E) se debe utilizar sólo cuando el módulo está conectado a otro módulo componible Henn.



Screws (D/E) are to be used only when this module is mated to another Henn buildable module.

## LISTA DE PEÇAS | LISTA DE PIEZAS | LIST OF PIECES

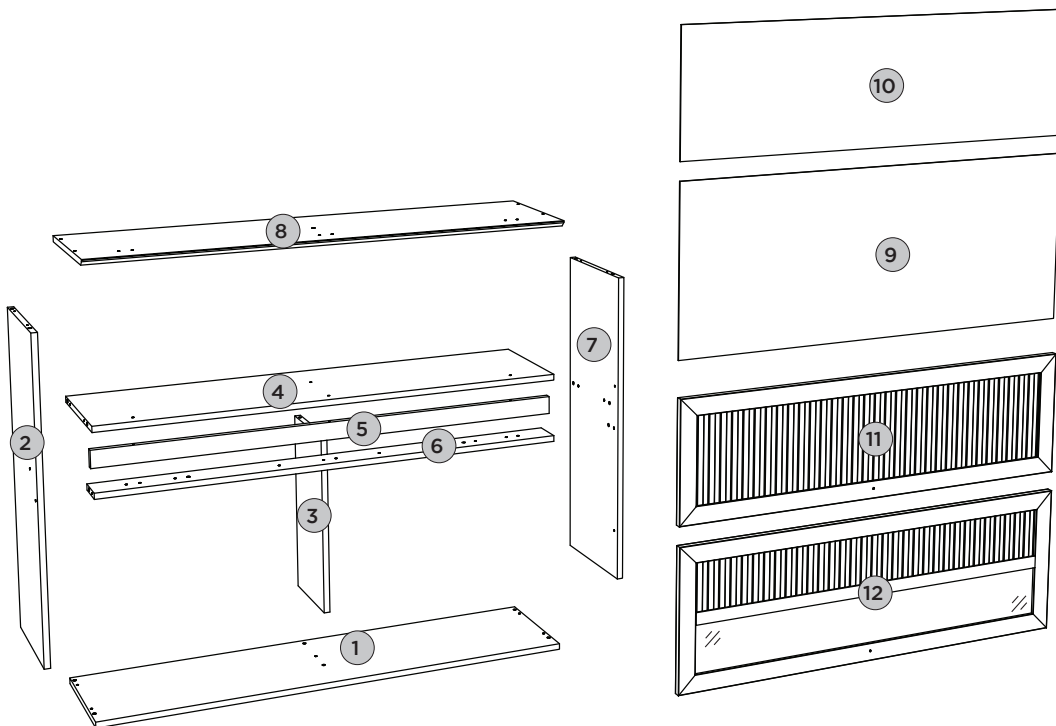

Item	Caixa Caja Box	Qty Ctd Qty	Descrição Descripción Description	Dimensões (mm)   Dimensiones (mm)		
				Comprimento Largo Length	Largura Ancho Width	Espessura Grosor Thickness
1	1/1	01	BASE   BASE   BASE	1200	295	15
2	1/1	01	LATERAL ESQUERDA   LATERAL IZQUIERDA   LEFT SIDE	800	295	15
3	1/1	01	DIVISÃO   DIVISIÓN   DIVISION	452	215	15
4	1/1	01	PRATELEIRA   ESTANTE   SHELF	1168	295	15
5	1/1	01	TRAVESSA FRONTAL   TRAVESAÑO FRONTAL   FRONT CROSSBAR	1168	45	15
6	1/1	01	TRAVESSA   TRAVESAÑO   CROSSBAR	1168	80	15
7	1/1	01	LATERAL DIREITA   LATERAL DERECHA   RIGHT SIDE	800	295	15
8	1/1	01	TAMPO   TAPA   TOP	1200	322	15
9	1/1	01	FUNDO INFERIOR   FONDO INFERIOR   LOWER BACKGROUND	1192	471	3
10	1/1	01	FUNDO SUPERIOR   FONDO SUPERIOR   UPPER BACKGROUND	1192	351	3
11	1/1	01	PORTA MOLDURA RIPADA   PUERTA CON MARCO RIPADA   STRIPPED FRAME DOOR	1195	345	18
12	1/1	01	PORTA MOLDURA RIPADA DE VIDRO   PUERTA CON MARCO VIDRIO RIPADA   RIPADA GLASS FRAME DOOR	1195	410	18

# PASSO 1

ITM/C631-

## PEÇAS REQUERIDAS

2	LATERAL ESQUERDA	x1
3	DIVISÃO	x1
4	PRATELEIRA	x1
5	TRAVESSA FRONTAL	x1
6	TRAVESSA	x1
7	LATERAL DIREITA	x1
8	TAMPO	x1

## ACESSÓRIOS REQUERIDOS

F		12
G		12
I		20
N		06
V		

## FERRAMENTAS NECESSÁRIAS

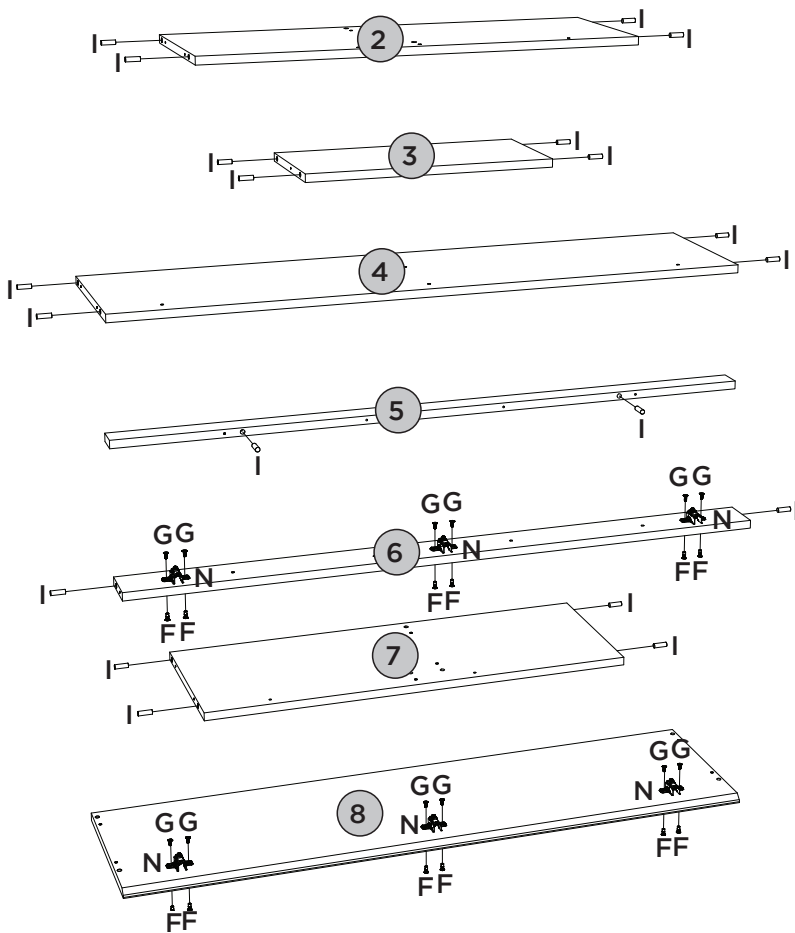
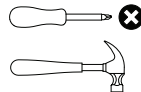

Utilizar o sachê de cola (V) em todas as cavilhas (I) do produto.

Con el pegamento sobre (V) en todos los pernos (I) producto.

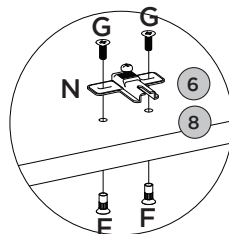

Use the glue sachet (V) on all the pegs (I) of the product.



## PEÇAS REQUERIDAS

1	BASE	x1
2	LATERAL ESQUERDA	x1
3	DIVISÃO	x1
4	PRATELEIRA	x1

## ACESSÓRIOS REQUERIDOS

B			06
V			

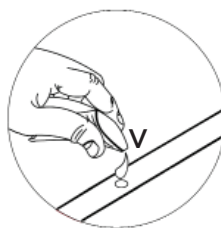
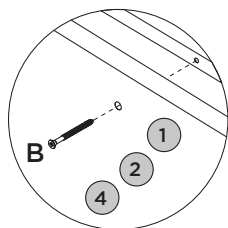
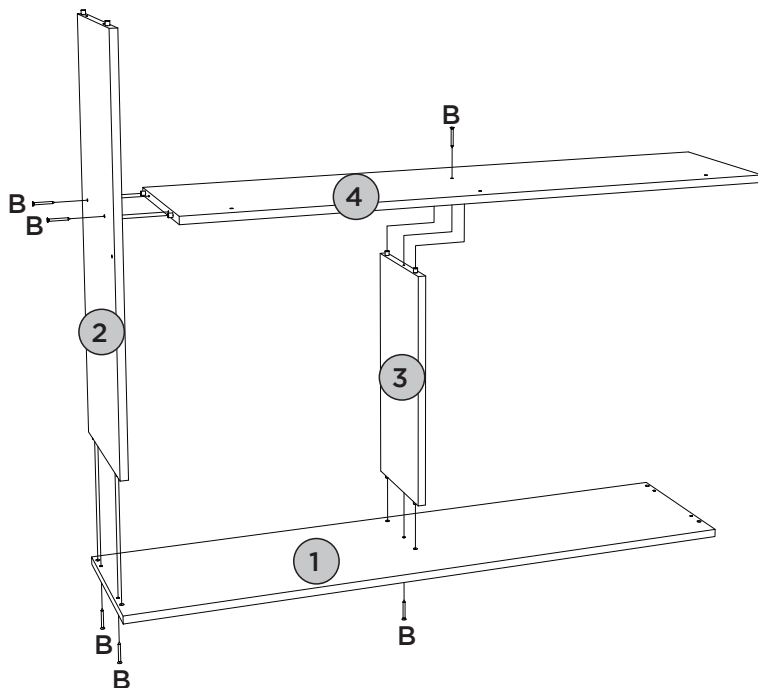
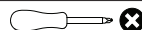

## FERRAMENTAS NECESSÁRIAS



## PEÇAS REQUERIDAS

5	TRAVESSA FRONTAL	x1
6	TRAVESSA	x1
7	LATERAL DIREITA	x1

## ACESSÓRIOS REQUERIDOS

B		10
V		

## FERRAMENTAS NECESSÁRIAS

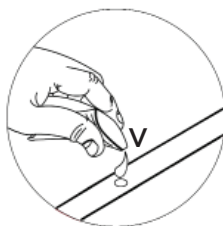
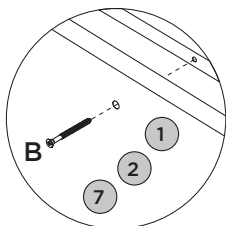
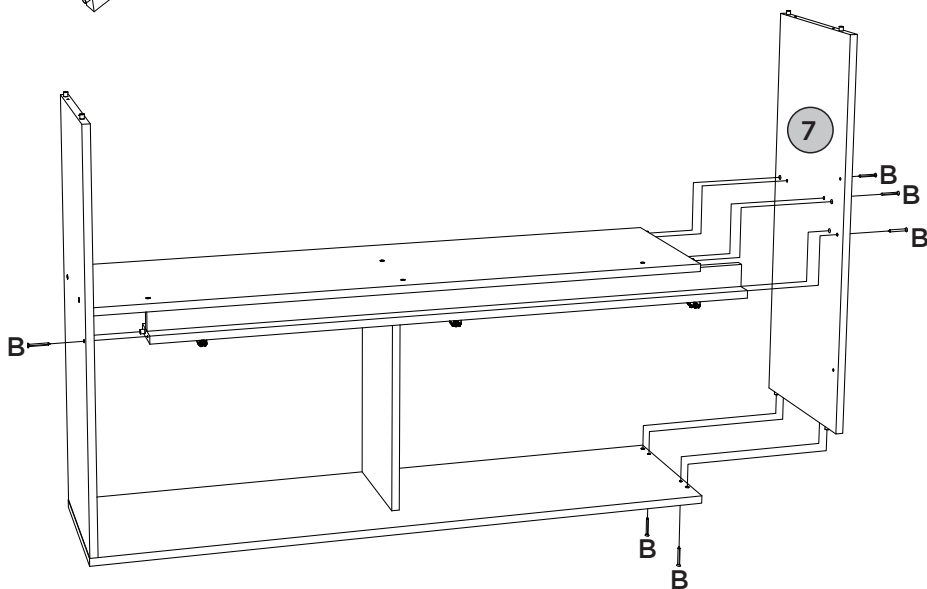
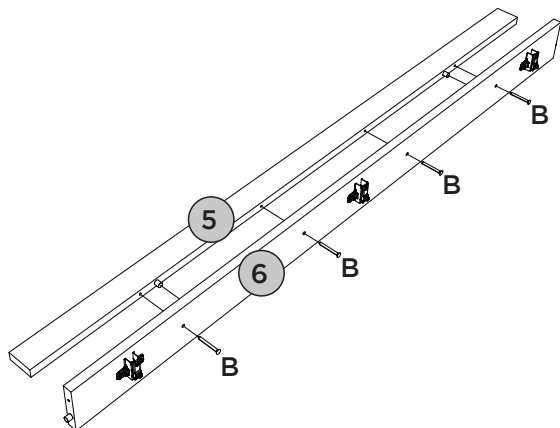
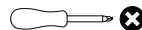



## PASSO 4

## PEÇAS REQUERIDAS

8	TAMPO	x1
---	-------	----

## ACESSÓRIOS REQUERIDOS

B		07
V		

## FERRAMENTAS NECESSÁRIAS

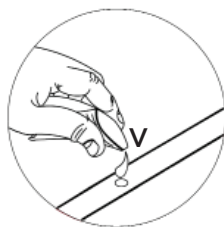
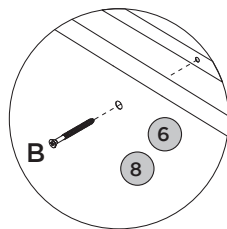
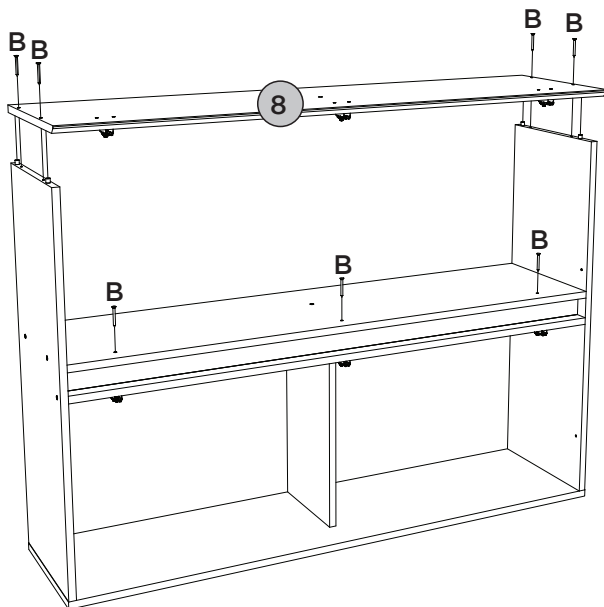
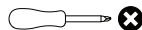



## PASSO 5

## PEÇAS REQUERIDAS

9	FUNDO INFERIOR	x1
10	FUNDO SUPERIOR	x1

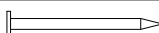
## ACESSÓRIOS REQUERIDOS

J		53
K		11

## FERRAMENTAS NECESSÁRIAS

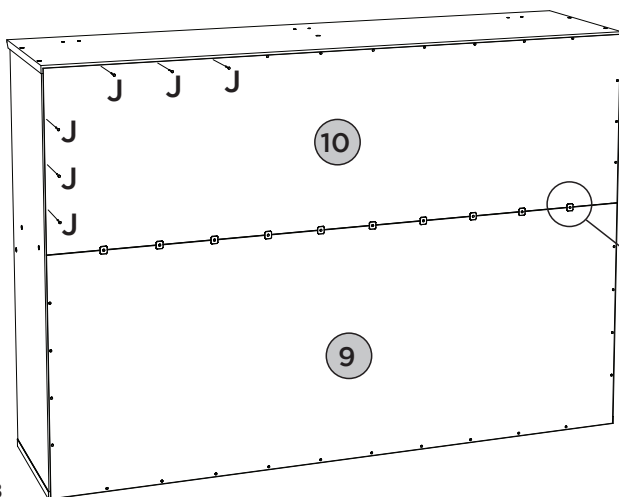

Fixar os pregos a uma distância de 100mm de um para outro.

Fijar las uñas a un distancia de 100mm uno a otro.

Fix the nails at a distance of 100mm from one to the other

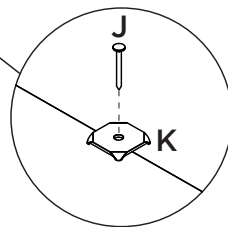





## PEÇAS REQUERIDAS

11	PORTA MOLDURA RIPADO	x1
12	PORTA MOLDURA RIPADO DE VIDRO	x1

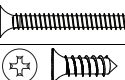
## ACESSÓRIOS REQUERIDOS

C		02
H		12
M		02
O		06

## FERRAMENTAS NECESSÁRIAS

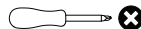

Para portas (11 e 12): Defina para o modo de perfuração.  
Faça a furação passante para fixar os puxadores (M).

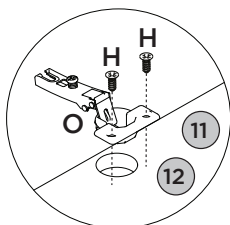
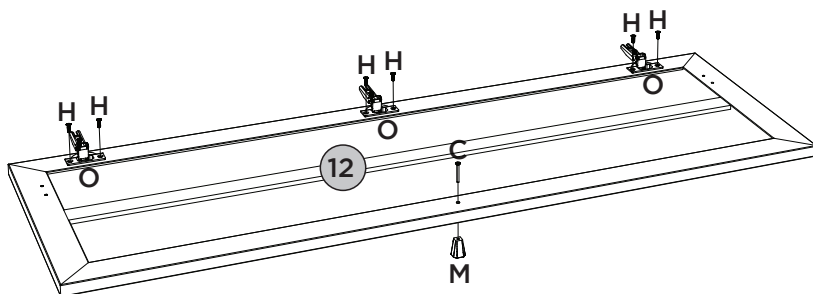
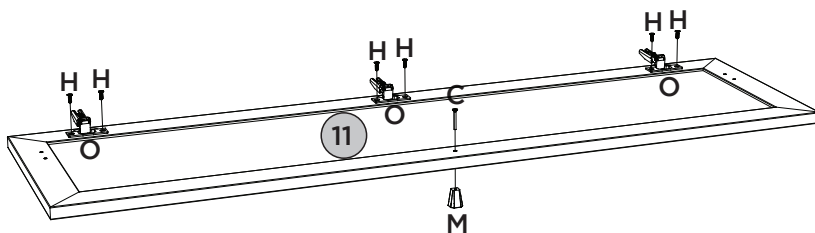

Video: Instalar e regular Dobradiças

Video: Instale y ajuste las bisagras

Video: Install and adjust hinges

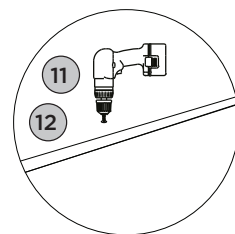

## PEÇAS REQUERIDAS

11	PORTA MOLDURA RIPADO	x1
12	PORTA MOLDURA RIPADO DE VIDRO	x1

## ACESSÓRIOS REQUERIDOS

L		04
P		04

## FERRAMENTAS NECESSÁRIAS

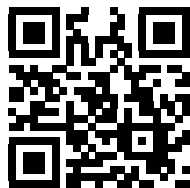
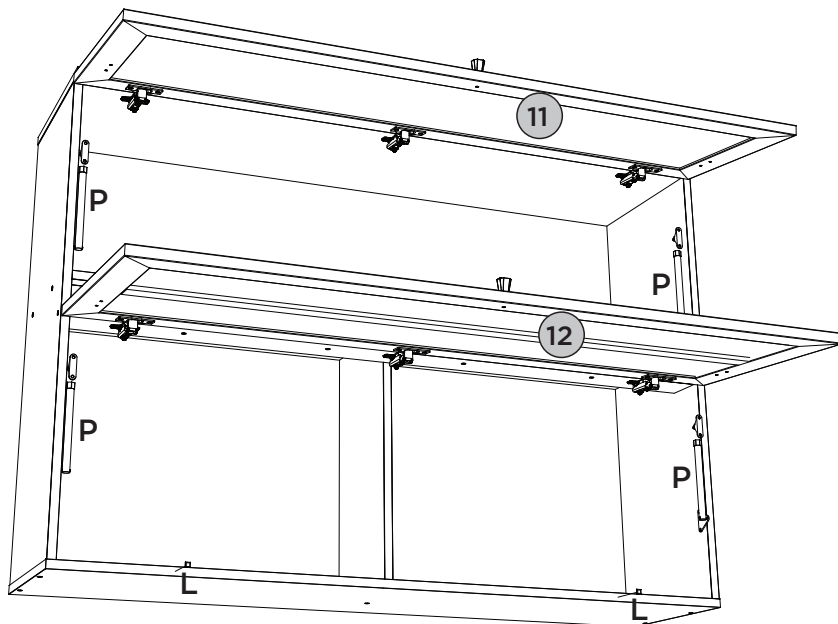
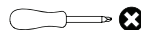







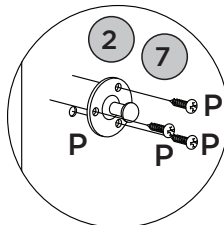
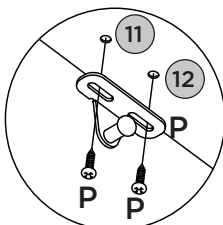
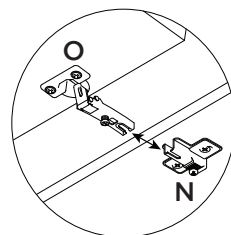
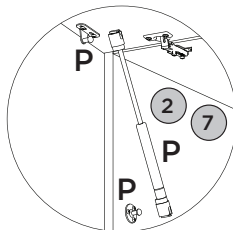

Vídeo: Dicas para instalar o Kit Pistão à Gás

Vídeo: Consejos para instalar el kit de pistón de gas

Vídeo: Tips for installing the Gas Piston Kit



ACESSÓRIOS REQUERIDOS

A		03
H		06
Q		03
R		03
S		03
T		26
U		02
W		01

FERRAMENTAS NECESSÁRIAS



OU

Para parede: Ajustar no modo perfuração  
Para peça (02, 03 e 07): Usar torque 5

Pesos máximos recomendados com carga distribuída  
Peso máximo recomendado con la carga distribuida  
Recommended maximum weight with distributed load.

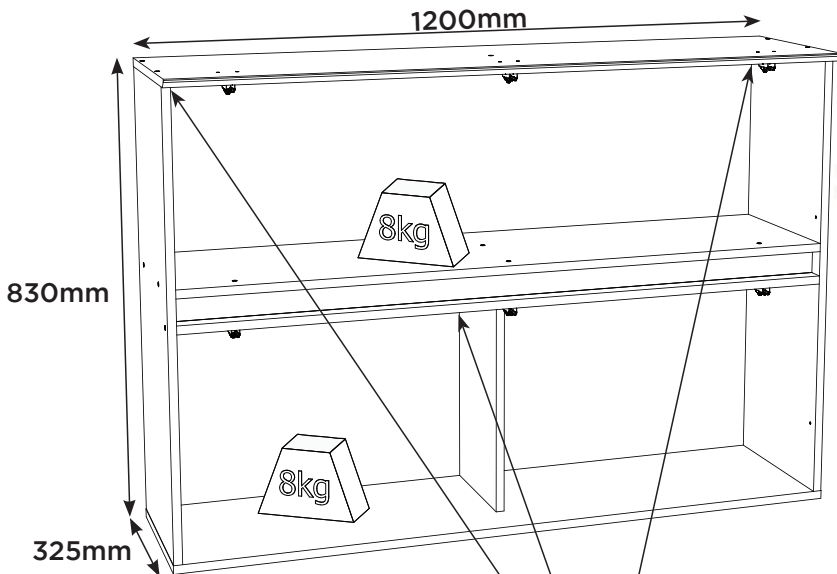

PERFECT CORRECTION  
CORRECCIÓN PERFECTA

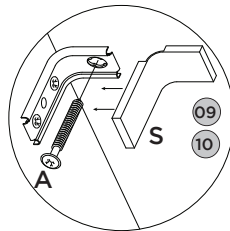
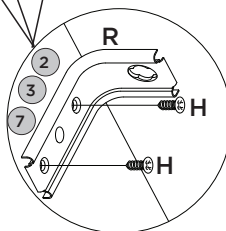
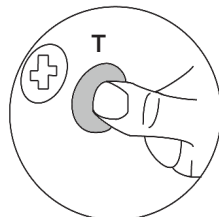
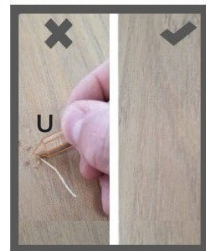

RECOMENDAÇÃO

Para fixar o móvel na parede usar o suporte de fixação (R), o parafuso 4,0x14mm CHT (H), a Bucha 8mm (Q) e o parafuso 5,0x50mm FLA (A).

RECOMENDACIÓN

Para conectar el móvil a la pared con el soporte (R), tornillo 4,0 x14mm CHT (H), el casquillo de 8 mm (Q) y el 5,0 x50mm tornillo FLA (A).

RECOMMENDATION

To fix the furniture to the wall use the fixing bracket (R), the 4,0x14mm CHT screw (H), the 8mm bushing (Q) and the 5.0x50mm FLA screw (A).

**Produto Concluído**  
**Producto terminado**  
**Finished Product**

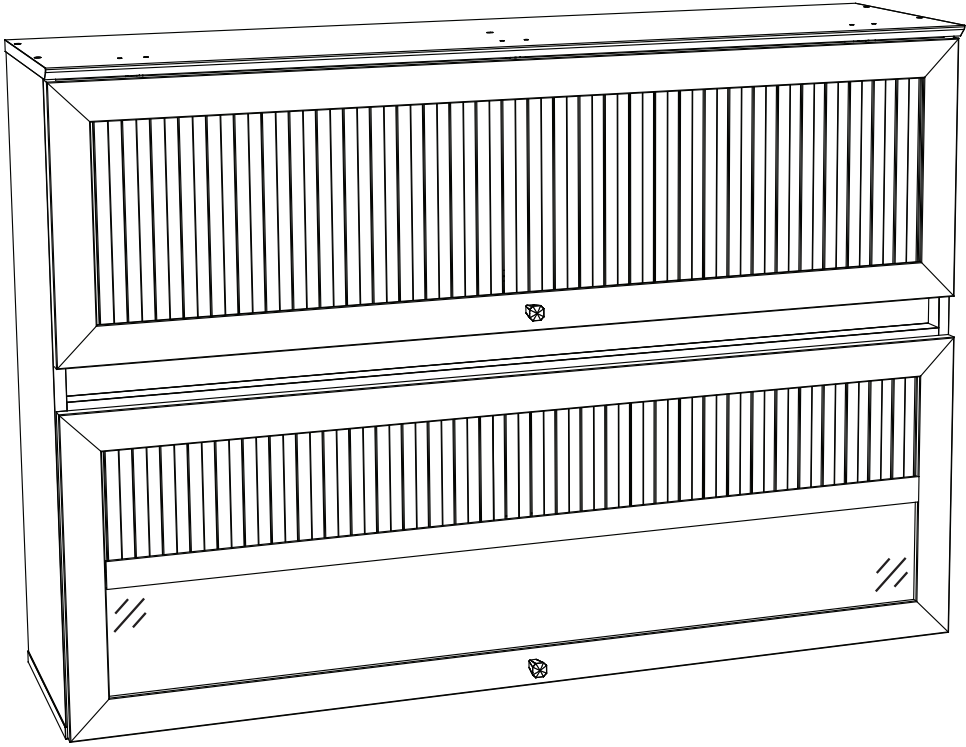

**HENN**Ind. e Com. de Móveis Henn  
Mondai - SC - Brasil

☎ +55 49 3674.3500

📧 @moveishenn  
www.henn.com.br**INSTRUÇÕES DE  
MONTAGEM**INSTRUCCIONES DE MONTAJE  
ASSEMBLY INSTRUCTIONS**Aéreo 01 Porta Basculante 800mm Requite | Aéreo 01  
Puerta Abatible 800mm Requite |  
Aerial 01 Tipper Door 800mm Requite**

C633-128 Nature

C633-217 Nature/Areia HP

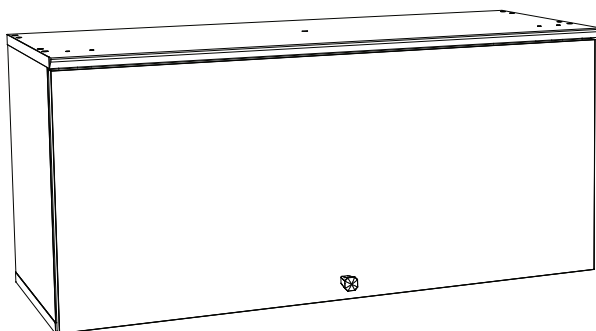
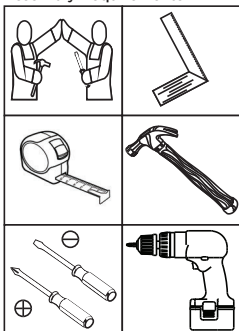
**Requisitos para montagem  
Requisitos para la montaje  
Assembly Requirements**

Imagens meramente ilustrativas,  
não acompanha o produto.  
Imágenes ilustrativas, no incluidas  
con el producto.  
Illustrative images, not included  
with the product.

**AVISO**

Para limpeza de seu móvel, use uma flanela seca ou umedecida, e não utilize produtos químicos que possam danificar seu produto.

**SISTEMA DE MONTAGEM**

O sistema de montagem dos produtos, funciona de acordo com a ordem crescente dos números indicados no desenho. Ex: 01, 02, 03, 04... até a conclusão da montagem.

**ASSISTÊNCIA TÉCNICA**

Para solicitação de Assistência Técnica você consumidor deverá entrar em contato com o Lojista o qual você realizou a compra deste produto e solicitar a assistência técnica das peças avariadas. A garantia abrange todas as peças, partes e componentes que eventualmente venham apresentar defeito de fabricação no prazo de 03 (três) meses, contando a partir da entrega do produto ao consumidor, mediante nota fiscal de compra. Se houver qualquer alteração na estrutura do produto ou ocorrer defeito por negligência do montador/consumidor em relação a instrução de montagem e manuseio, não será fornecido assistência técnica gratuita.

**ADVERTENCIA**

Para limpeza de su móvil, use una franela seca o húmeda, y no utilice productos químicos que puedan dañar su producto.

**SISTEMA DE MONTAJE**

El sistema de montaje de los productos funciona de acuerdo con el orden creciente de los números indicados en el dibujo. Ej.: 01, 02, 03, 04... hasta la conclusión del montaje.

**ASISTENCIA TÉCNICA**

Para solicitar Asistencia Técnica, el consumidor debe comunicarse con el Comercio que usted realizó la compra de este producto y solicita asistencia técnica para las partes dañadas. La garantía cubre todas las partes, piezas y componentes que eventualmente puedan presentar defecto de fabricación en el plazo de 03 (tres) meses, contados a partir de la entrega del producto al consumidor, mediante factura de compra. Si se produce algún cambio en la estructura del producto o se produce un defecto por negligencia del montador/consumidor en relación con las instrucciones de montaje y manipulación, no se prestará asistencia técnica gratuita.

**NOTICE**

To clean your furniture, use a dry or wet cloth, and do not use chemicals that may damage your product.

**ASSEMBLY SYSTEM**

The products' assembly system works according to the increasing order of the indicated numbers. For example: 01, 02, 03, 04 ... to the end of the assembly.

**TECHNICAL ASSISTANCE**

To request Technical Assistance, the consumer must contact the retailer from whom you purchased this product and request technical assistance for the damaged parts. The warranty covers all parts, parts and components that may eventually present a manufacturing defect within a period of 03 (three) months, counting from the delivery of the product to the consumer, by means of a purchase invoice. If there is any change in the structure of the product or defect occurs due to negligence of the assembler/consumer in relation to the assembly and handling instruction, free technical assistance will not be provided.

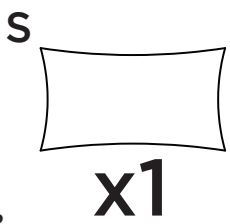
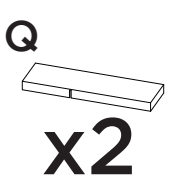
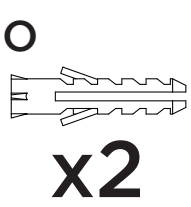
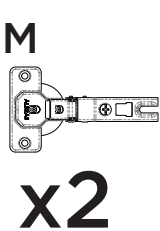
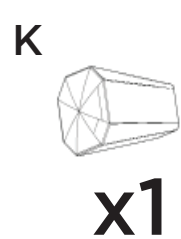
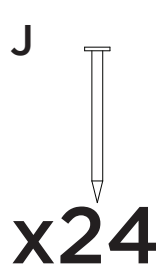
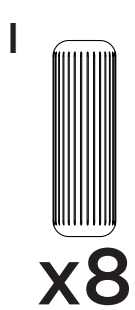
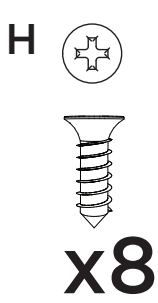
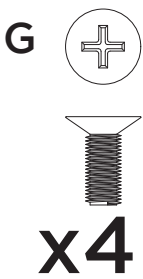
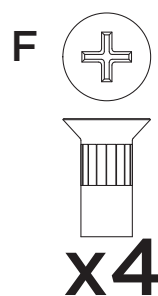
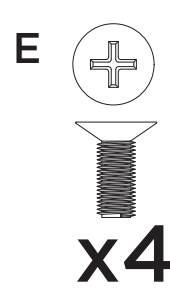
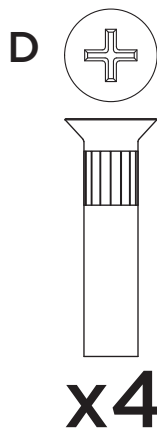
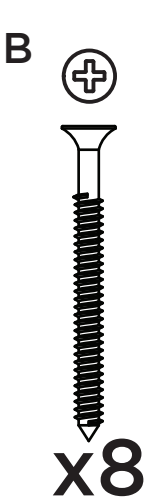
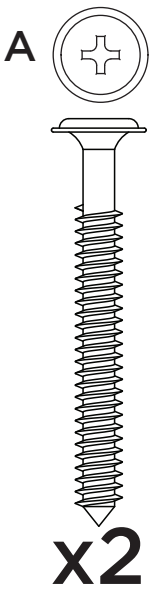

Parafusos em escala  
Tornillos escalados  
Scaled screws **1:1**

 Os parafusos (D/E) devem ser usados somente quando este módulo for acoplado a outro módulo componível Henn.

 Los tornillos (D/E) se debe utilizar sólo cuando el módulo está conectado a otro módulo componible Henn.

 Screws (D/E) are to be used only when this module is mated to another Henn buildable module.

# LISTA DE PEÇAS | LISTA DE PIEZAS | LIST OF PIECES

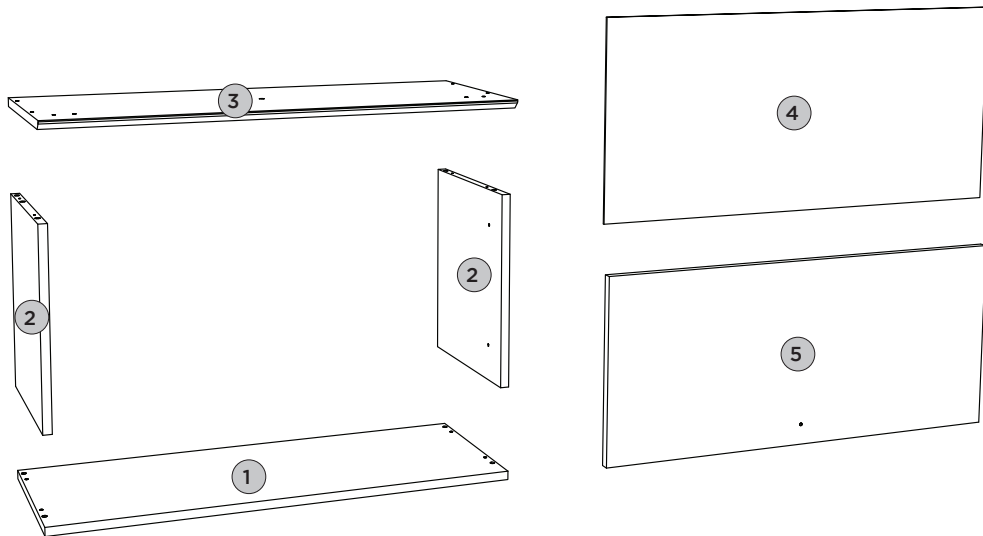





Item	Caixa Caja Box	Qtd Ctd Qty	Descrição Descripción Description	Dimensões (mm)   Dimensiones (mm)		
				Comprimento Largo Length	Largura Ancho Width	Espessura Grosor Thickness
1	1/1	01	BASE   BASE   BASE	800	295	15
2	1/1	02	LATERAL DIREITA ESQUERDA   LATERAL DERECHA IZQUIERDA   RIGHT LEFT SIDE	337	295	15
3	1/1	01	TAMPO   TAPA   TOP	800	322	15
4	1/1	01	FUNDO   FONDO   BACKGROUND	793	361	3
5	1/1	01	PORTA BASCULANTE   PUERTA BASCULANTE   BASCULATING DOOR	796	345	15

**PASSO 1****PEÇAS REQUERIDAS**

2	LATERAL DIREITA ESQUERDA	x2
3	TAMPO	x1

**ACESSÓRIOS REQUERIDOS**

F		04
G		04
I		08
L		02
S		

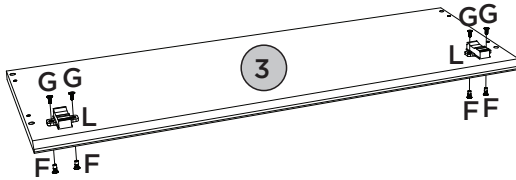
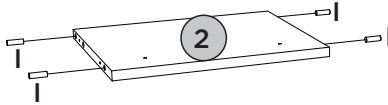
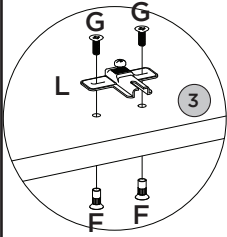
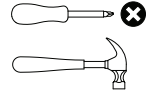
**FERRAMENTAS NECESSÁRIAS**

Utilizar o sachê de cola (S) em todas as cavilhas (I) do produto.



Con el pegamento sobre (S) en todos los pernos (I) producto.

Use the glue sachet (S) on all the pegs (I) of the product.

**PASSO 2****PEÇAS REQUERIDAS**

1	BASE	x1
2	LATERAL DIREITA ESQUERDA	x2
3	TAMPO	x1

**ACESSÓRIOS REQUERIDOS**

B		08
S		

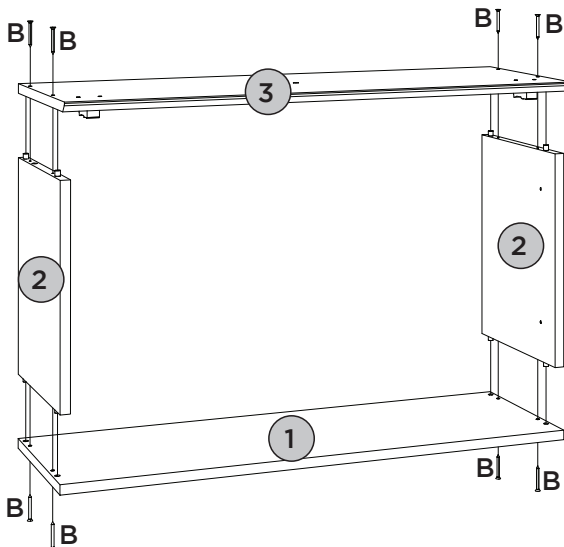
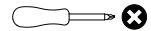
**FERRAMENTAS NECESSÁRIAS**



# PASSO 3

ITM/C633-

## PEÇAS REQUERIDAS

4	FUNDO	x1
---	-------	----

## ACESSÓRIOS REQUERIDOS

J		24
---	---	----

## FERRAMENTAS NECESSÁRIAS

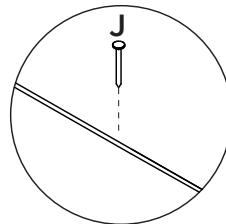
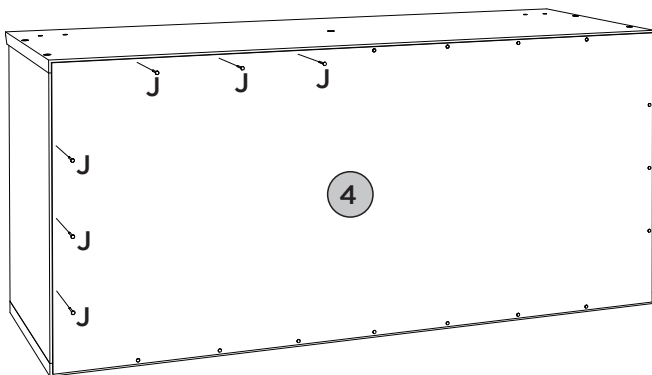
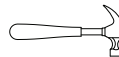

Fixar os pregos a uma distância de 100mm de um para outro.

Fijar las uñas a un distancia de 100mm uno a otro.







Fix the nails at a distance of 100mm from one to the other

# PASSO 4

## PEÇAS REQUERIDAS

5	PORTA BASCULANTE	x1
---	------------------	----

## ACESSÓRIOS REQUERIDOS

C	 	01
H	 	04
K		01
M		02

## FERRAMENTAS NECESSÁRIAS

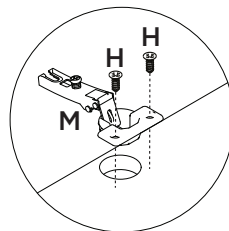
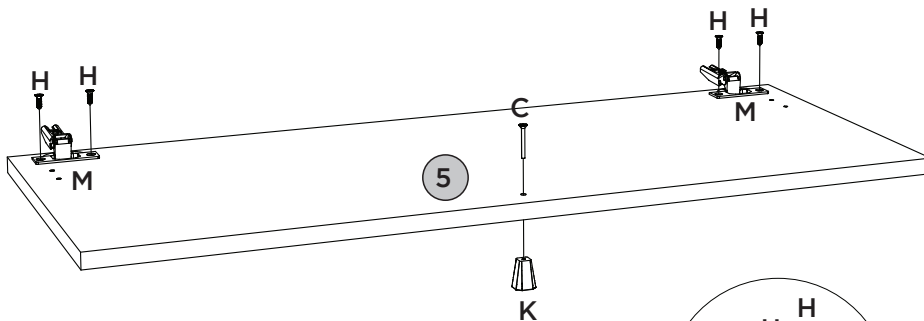
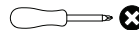

## PEÇAS REQUERIDAS

5	PORTA BASCULANTE	x1
---	------------------	----

## ACESSÓRIOS REQUERIDOS

N		01
---	--	----

## FERRAMENTAS NECESSÁRIAS

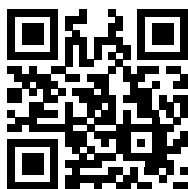
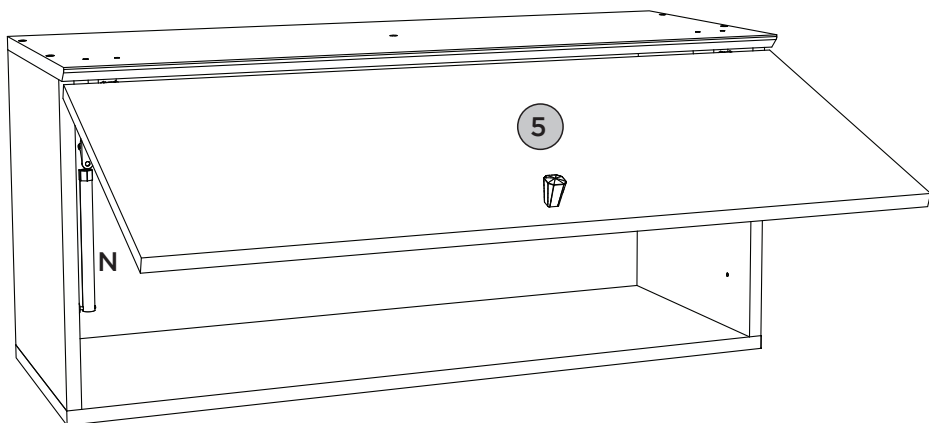
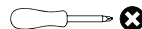

Vídeo: Dicas para instalar o Kit Pistão à Gás

Vídeo: Consejos para instalar el kit de pistón de gas

Vídeo: Tips for installing the Gas Piston Kit

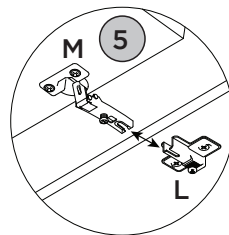
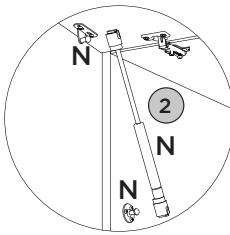
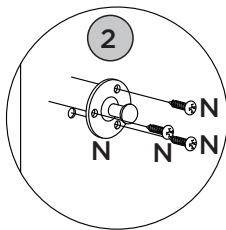
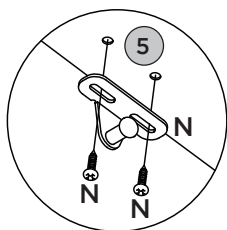

ACESSÓRIOS REQUERIDOS

A		02
H		04
O		02
P		02
Q		02
R		10

FERRAMENTAS NECESSÁRIAS



OU

Para parede: Ajustar no modo perfuração  
Para peça (O2): Usar torque 5

Pesos máximos recomendados com carga distribuída  
Peso máximo recomendado con la carga distribuida  
Recommended maximum weight with distributed load.

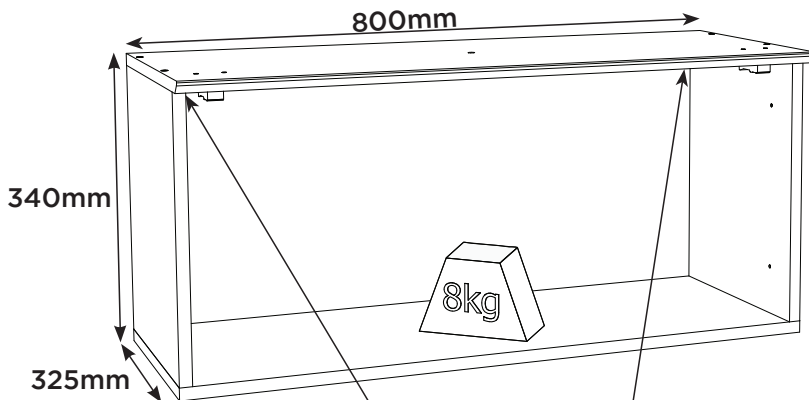

RECOMENDAÇÃO

Para fixar o móvel na parede usar o suporte de fixação (P), o parafuso 4,0x14mm CHT (H), a Bucha 8mm (O) e o parafuso 5,0x50mm FLA (A).

RECOMENDACIÓN

Para conectar el móvil a la pared con el soporte (P), tornillo 4,0 x14mm CHT (H), el casquillo de 8 mm (O) y el 5,0 x50mm tornillo FLA (A).

RECOMMENDATION

To fix the furniture to the wall use the fixing bracket (P), the 4,0x14mm CHT (H) screw, the 8mm bushing (O) and the 5,0x50mm FLA screw (A).

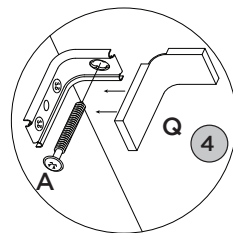
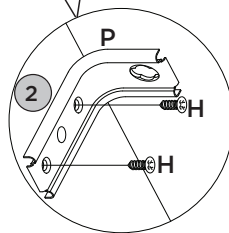
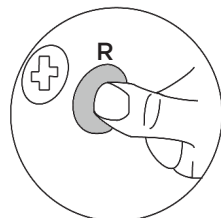

**Produto Concluído**  
**Producto terminado**  
**Finished Product**

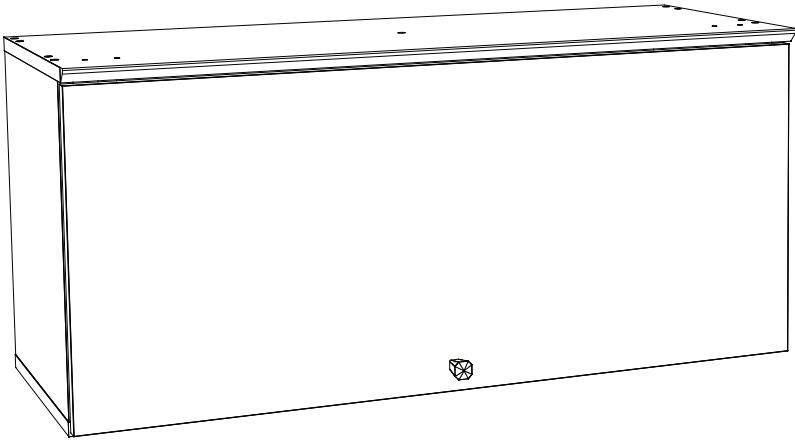

**HENN**Ind. e Com. de Móveis Henn  
Mondai - SC - Brasil

☎ +55 49 3674.3500

📧 @moveishenn  
www.henn.com.br**INSTRUÇÕES DE  
MONTAGEM**INSTRUCCIONES DE MONTAJE  
ASSEMBLY INSTRUCTIONS**Aéreo Canto Reto 01 Porta Requite |  
Aire Esquina Recto 01 Puerta Requite |  
Aerial Corner Challenge 01 Door Requite**

C634-128 Nature

C634-217 Nature/Areia HP

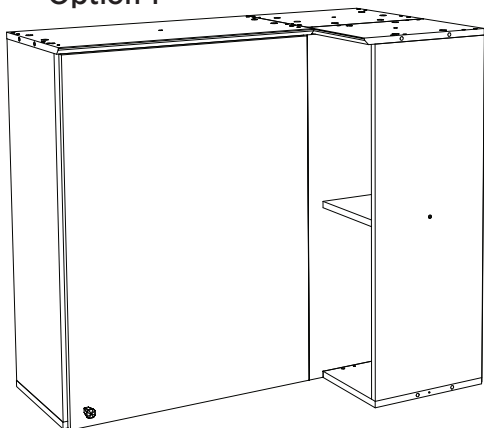
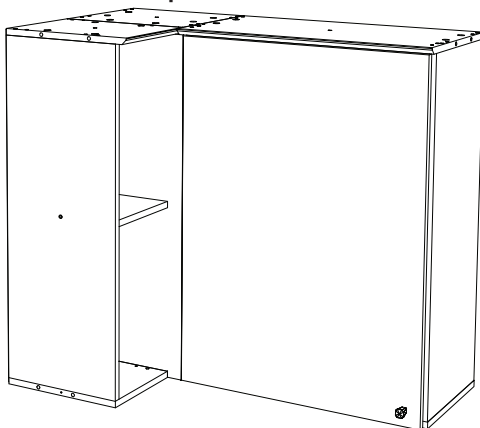
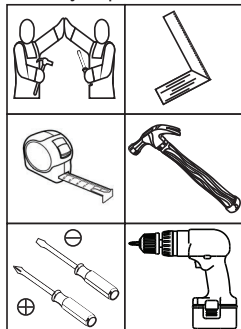
Opção 1  
Opción 1  
Option 1Opção 2  
Opción 2  
Option 2Requisitos para montagem  
Requisitos para la montaje  
Assembly RequirementsImagens meramente ilustrativas,  
não acompanha o produto.  
Imágenes ilustrativas, no incluidas  
con el producto.  
Illustrative images, not included  
with the product.**AVISO**

Para limpeza de seu móvel, use uma flanela seca ou umedecida, e não utilize produtos químicos que possam danificar seu produto.

**SISTEMA DE MONTAGEM**O sistema de montagem dos produtos, funciona de acordo com a ordem crescente dos números indicados no desenho.  
Ex: 01, 02, 03, 04... até a conclusão da montagem.**ASSISTÊNCIA TÉCNICA**

Para solicitação de Assistência Técnica você consumidor deverá entrar em contato com o Lojista o qual você realizou a compra deste produto e solicitar a assistência técnica das peças avariadas. A garantia abrange todas as peças, partes e componentes que eventualmente venham apresentar defeito de fabricação no prazo de 03 (três) meses, contando a partir da entrega do produto ao consumidor, mediante nota fiscal de compra. Se houver qualquer alteração na estrutura do produto ou ocorrer defeito por negligência do montador/consumidor em relação a instrução de montagem e manuseio, não será fornecido assistência técnica gratuita.

**ADVERTENCIA**

Para limpieza de su móvil, use una flanela seca o húmeda, y no utilice productos químicos que puedan dañar su producto.

**SISTEMA DE MONTAJE**

El sistema de montaje de los productos funciona de acuerdo con el orden creciente de los números indicados en el dibujo. Ej.: 01, 02, 03, 04... hasta la conclusión del montaje.

**ASISTENCIA TÉCNICA**

Para solicitar Asistencia Técnica, el consumidor debe comunicarse con el Comercio que usted realizó la compra de este producto y solicita asistencia técnica para las partes dañadas. La garantía cubre todas las partes, piezas y componentes que eventualmente puedan presentar defecto de fabricación en el plazo de 03 (tres) meses, contados a partir de la entrega del producto al consumidor, mediante factura de compra. Si se produce algún cambio en la estructura del producto o se produce un defecto por negligencia del montador/consumidor en relación con las instrucciones de montaje y manipulación, no se prestará asistencia técnica gratuita.

**NOTICE**

To clean your furniture, use a dry or wet cloth, and do not use chemicals that may damage your product.

**ASSEMBLY SYSTEM**

The products' assembly system works according to the increasing order of the indicated numbers. For example: 01, 02, 03, 04 ... to the end of the assembly.

**TECHNICAL ASSISTANCE**

To request Technical Assistance, the consumer must contact the retailer from whom you purchased this product and request technical assistance for the damaged parts. The warranty covers all parts, parts and components that may eventually present a manufacturing defect within a period of 03 (three) months, counting from the delivery of the product to the consumer, by means of a purchase invoice. If there is any change in the structure of the product or defect occurs due to negligence of the assembler/consumer in relation to the assembly and handling instruction, free technical assistance will not be provided.

ACESSÓRIOS | ACCESORIOS | ACCESSORIES

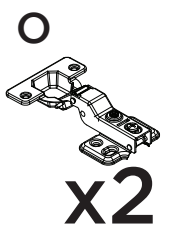
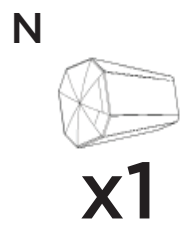
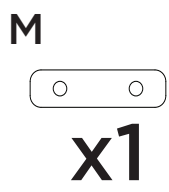
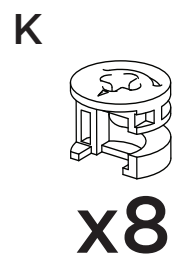
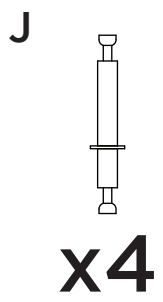
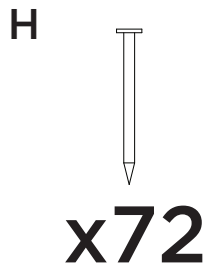
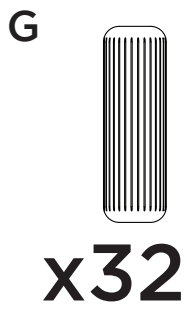
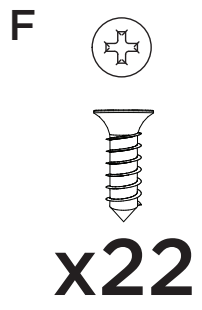
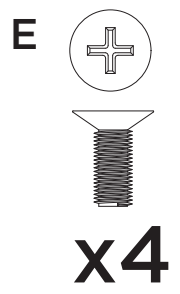
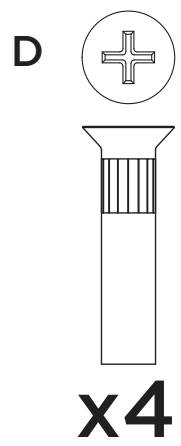
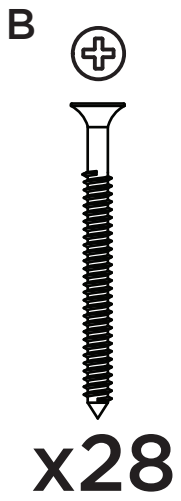
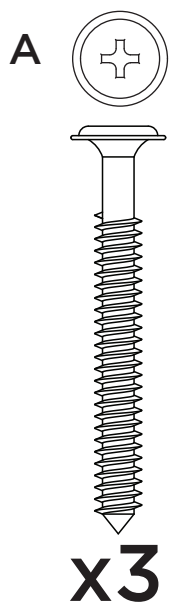

Parafusos em escala  
Tornillos escalados  
Scaled screws **1:1**

# ACESSÓRIOS | ACCESORIOS | ACCESSORIES

P

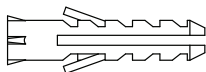

**x3**

Q

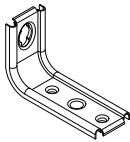

**x3**

R

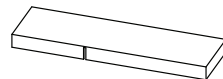

**x3**

S

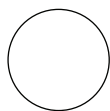

**x30**

T

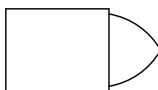

**x2**

U

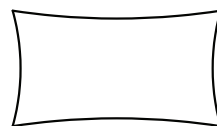

**x2**



Os parafusos (D/E) devem ser usados somente quando este módulo for acoplado a outro módulo componível Henn.



Los tornillos (D/E) se debe utilizar sólo cuando el módulo está conectado a otro módulo componible Henn.



Screws (D/E) are to be used only when this module is mated to another Henn buildable module.

## LISTA DE PEÇAS | LISTA DE PIEZAS | LIST OF PIECES

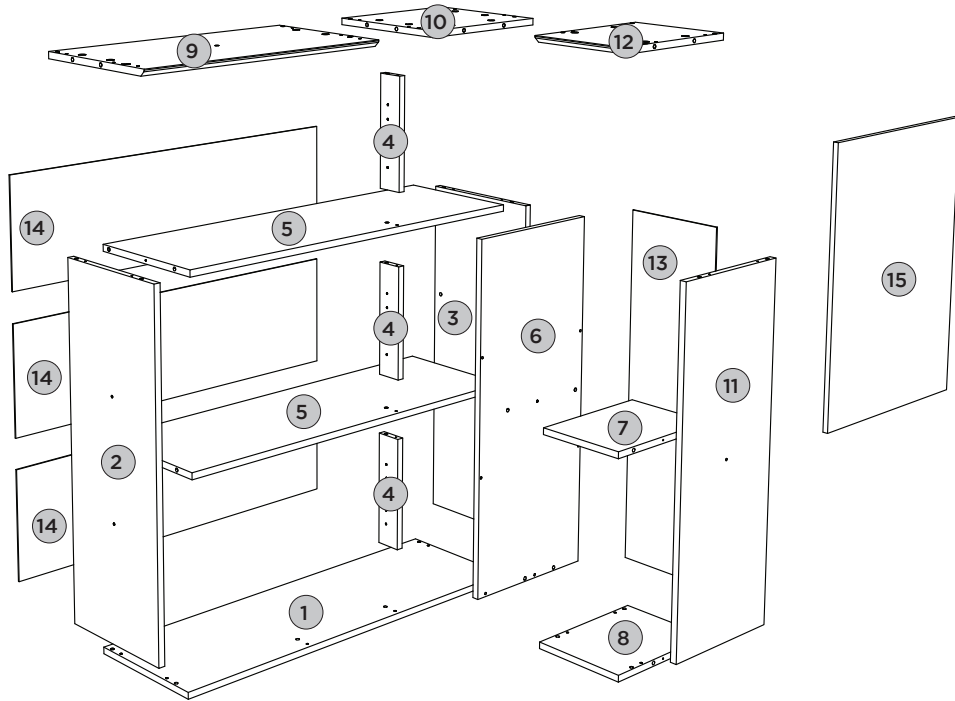

Item	Caixa Caja Box	Qty Ctd Qty	Descrição Descripción Description	Dimensões (mm)   Dimensions (mm)   Dimensions (mm)		
				Comprimento Largo Length	Largura Ancho Width	Espessura Grosor Thickness
1	1/1	01	BASE   BASE   BASE	940	295	15
2	1/1	01	LATERAL ESQUERDA   LATERAL IZQUIERDA   LEFT SIDE	800	295	15
3	1/1	01	FUNDO 15MM   FONDO 15MM   15MM BOTTOM	800	295	15
4	1/1	03	PILASTRA DA PORTA   PUERTA PILASTRA   DOOR PILASTER	256	60	15
5	1/1	02	PRATELEIRA   ESTANTE   SHELF	909	295	15
6	1/1	01	FRENTE FIXA   FRENTE FIJA   FIXED FRONT	815	333	15
7	1/1	01	PRATELEIRA NICHU   ESTANTERIA DE NICHU   NICHE SHELF	293	208	15
8	1/1	01	BASE NICHU   NICHU BASE   BASE NICHE	295	223	15
9	1/1	01	TAMPO MAIOR   TAPA MAYOR   TOP SURFACE	618	322	15
10	1/1	01	TAMPO MENOR   TAPA MAYOR   TOP SURFACE	322	295	15
11	1/1	01	LATERAL DIREITA NICHU   NICHU LADO DERECHO   RIGHT SIDE NICHE	800	295	15
12	1/1	01	TAMPO NICHU   TAPA NICHU   NICHE TOP	322	238	15
13	1/1	01	FUNDO MENOR   FONDO MENOR   MINOR FUND	824	235	3
14	1/1	03	FUNDO   FONDO   BOTTOM	933	273	3
15	1/1	01	PORTA   PUERTA   DOOR	813	597	15





# PASSO 1

ITM/C634-

## PEÇAS REQUERIDAS

2	LATERAL ESQUERDA	x1
3	FUNDO 15MM	x1
4	PILASTRA DA PORTA	x3

## ACESSÓRIOS REQUERIDOS

G		14
U		

## FERRAMENTAS NECESSÁRIAS

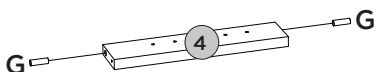
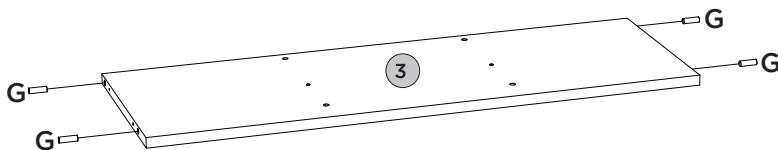
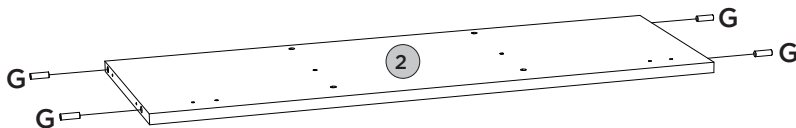
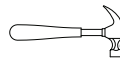

Utilizar o sachê de cola (U) em todas as cavilhas (G) do produto.

Con el pegamento sobre (U) en todos los pernos (G) producto.

Use the glue sachet (U) on all the pegs (G) of the product.



# PASSO 2

ITM/C634-

## PEÇAS REQUERIDAS

5	PRATELEIRA	x2
7	PRATELEIRA NICHU	x1
11	LATERAL DIREITA NICHU	x1

## ACESSÓRIOS REQUERIDOS

G		16
U		

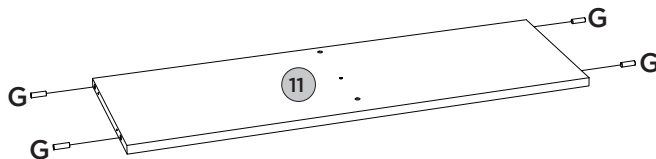
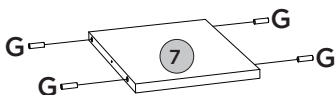
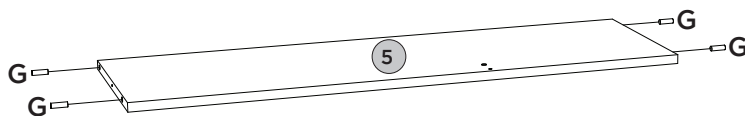
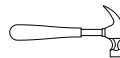

## FERRAMENTAS NECESSÁRIAS



## PEÇAS REQUERIDAS

1	BASE	x1
2	LATERAL ESQUERDA	x1
3	FUNDO 15MM	x1
4	PILASTRA DA PORTA	x3
5	PRATELEIRA	x2

## ACESSÓRIOS REQUERIDOS

B		11
U		

## FERRAMENTAS NECESSÁRIAS

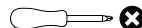

### Opção 1 Opción 1 Option 1

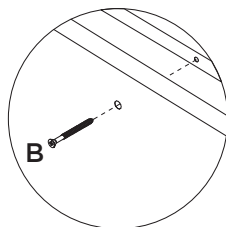
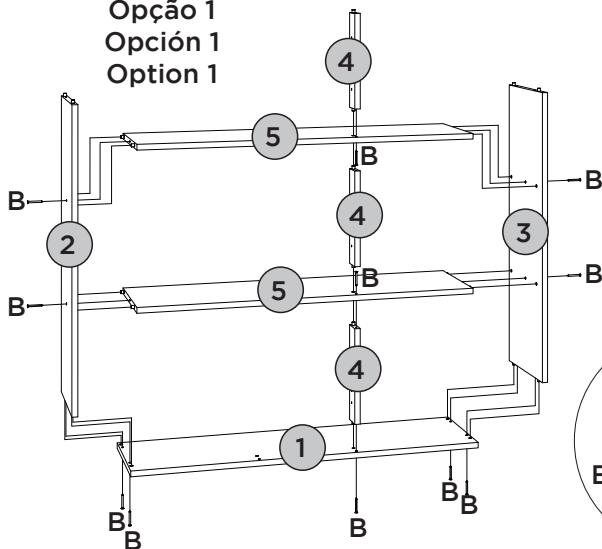

### Opção 2 Opción 2 Option 2

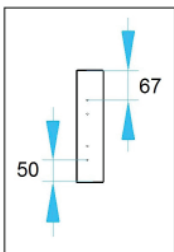
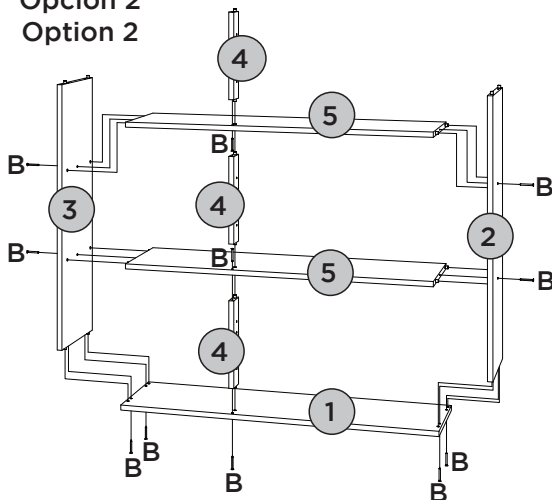

Peça (04) com o lado da pinção de 50mm para baixo.

Parte (04) con el lado del orificio de 50mm hacia abajo.

Part (04) with the side of the pinhole of 50mm down.



# PASSO 4

ITM/C634-

## PEÇAS REQUERIDAS

6	FRENTE FIXA	x1
7	PRATELEIRA NICHU	x1
8	BASE NICHU	x1

## ACESSÓRIOS REQUERIDOS

B		02
G		02
U		

## FERRAMENTAS NECESSÁRIAS

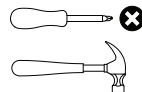

### Opção 1 Opción 1 Option 1

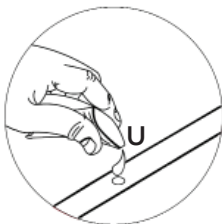
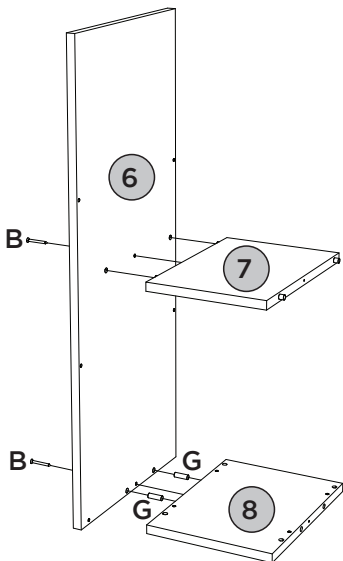

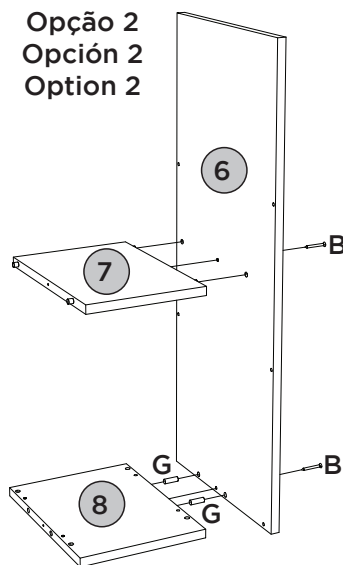

### Opção 2 Opción 2 Option 2



## PEÇAS REQUERIDAS

9	TAMPO MAIOR	x1
10	TAMPO	x1

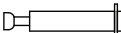
## ACESSÓRIOS REQUERIDOS

J		02
K		04

## FERRAMENTAS NECESSÁRIAS

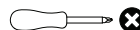

Opção 1  
Opción 1  
Option 1

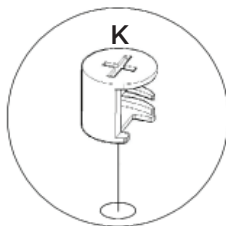
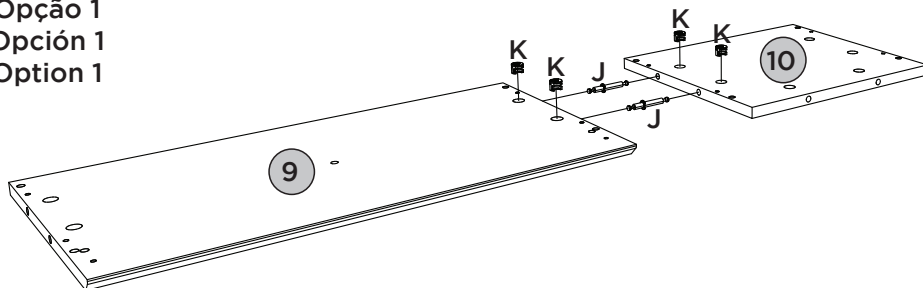



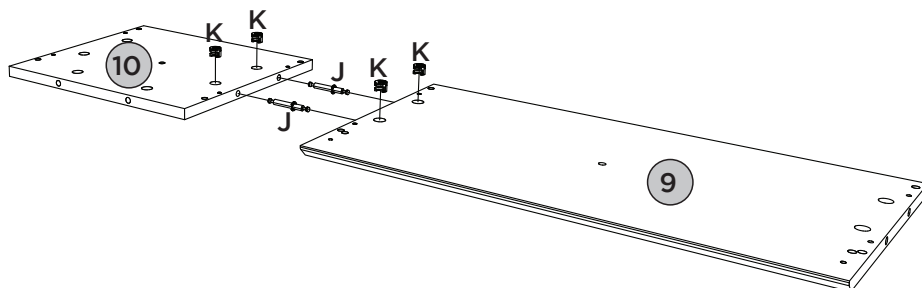



Opção 2  
Opción 2  
Option 2

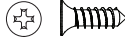

## ACESSÓRIOS REQUERIDOS

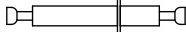
## FERRAMENTAS NECESSÁRIAS

B		10	K		02
F		02	L		01
J		02	U		

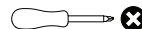

Opção 1

Opcción 1

Option 1

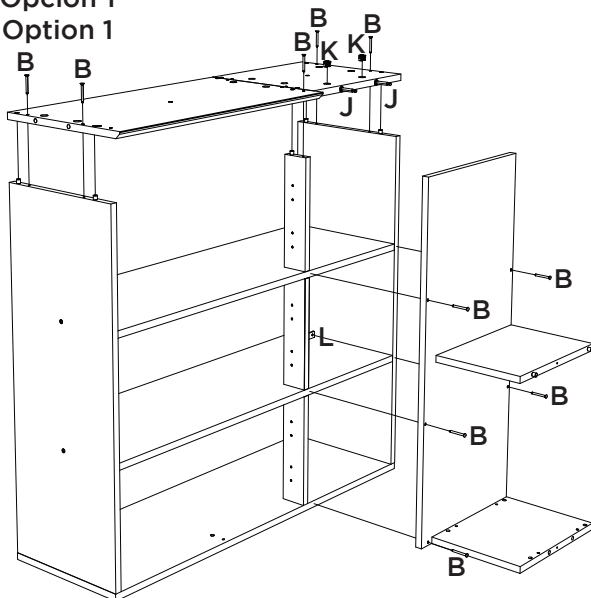

Na opção do Nicho, recomenda-se apertar as ferragens J e K antes de fixar a peça 06.

En la opción de nicho, se recomienda para apretar los accesorios J y K antes de fijar la pieza 06.

In the Niche, it is recommended to tighten the hardware J and K before securing part 06.

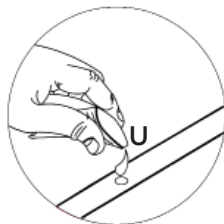
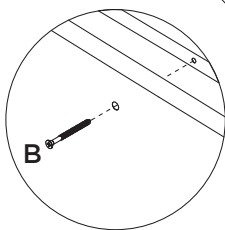
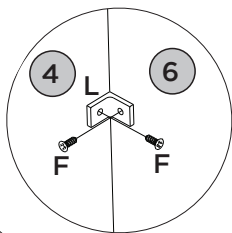

Opção 2  
Opcción 2  
Option 2

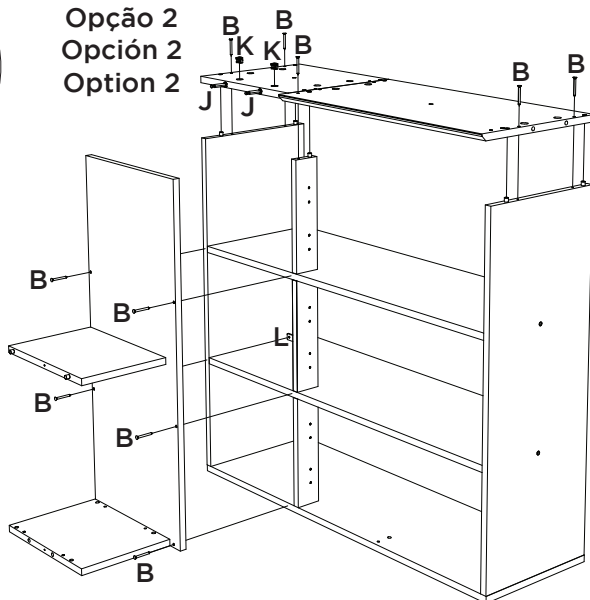



# PASSO 7

ITM/C634-

## PEÇAS REQUERIDAS

11	LATERAL DIREITA NICHOS	x1
12	TAMPO NICHOS	x1

## ACESSÓRIOS REQUERIDOS

B		05
K		02
U		

## FERRAMENTAS NECESSÁRIAS

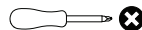

Opção 1  
Opción 1  
Option 1

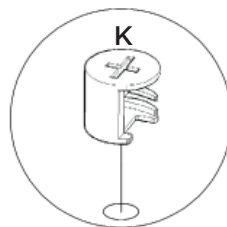
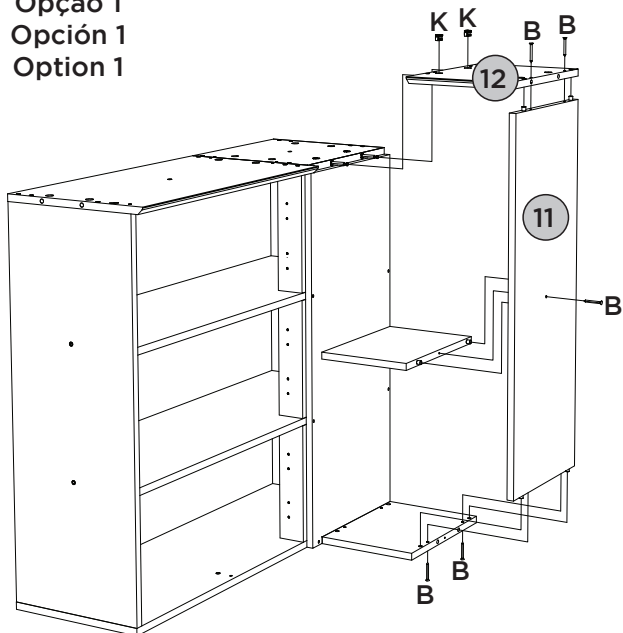

Opção 2  
Opción 2  
Option 2

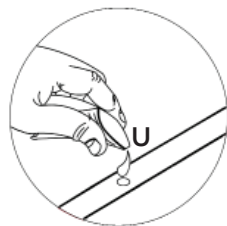
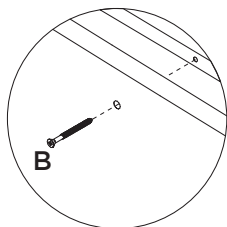
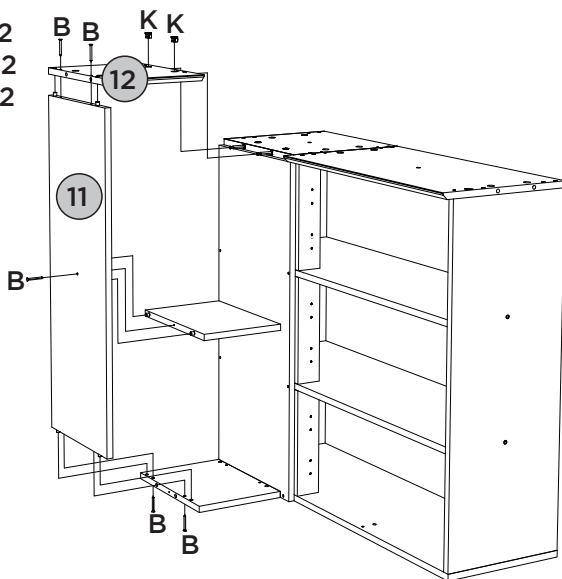



# PASSO 8

ITM/C634-

## PEÇAS REQUERIDAS

13	FUNDO MENOR	x1
14	FUNDO	x3

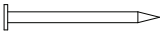
## ACESSÓRIOS REQUERIDOS

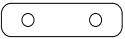
F		02
H		72
I		16
M		01

## FERRAMENTAS NECESSÁRIAS

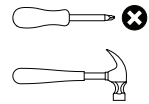

Opção 1  
Opción 1  
Option 1

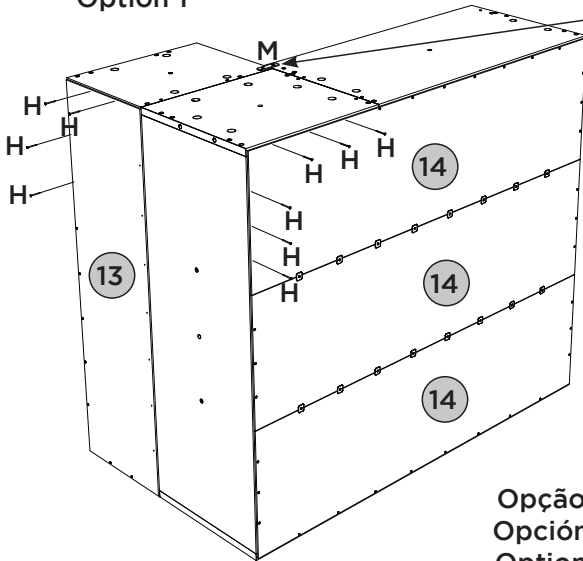

Fixar os pregos a uma distância de 100mm de um para outro.

Fijar las uñas a un distancia de 100mm uno a otro.

Fix the nails at a distance of 100mm from one to the other

Opção 2  
Opción 2  
Option 2

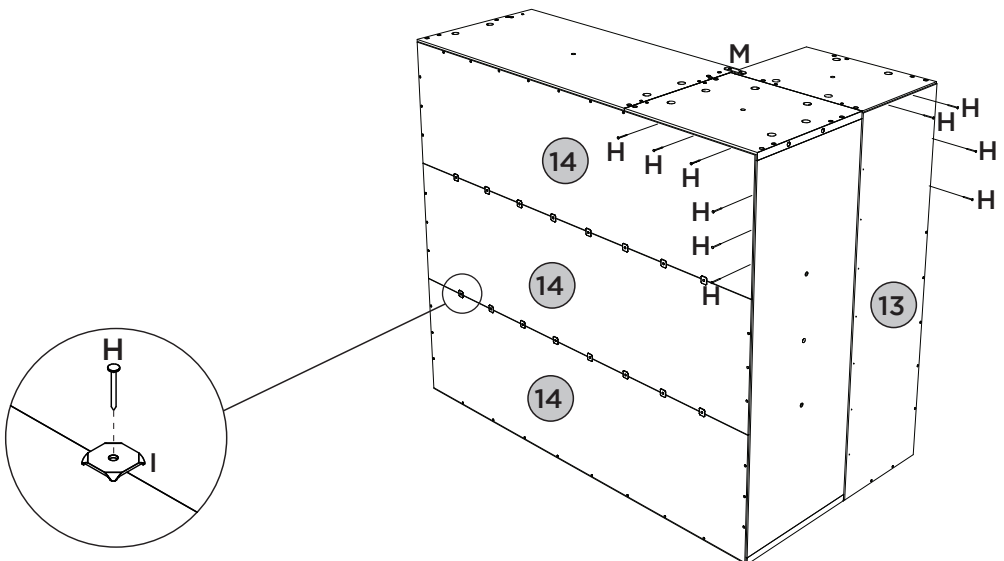





## PEÇAS REQUERIDAS

15	PORTA	x1
----	-------	----

## ACESSÓRIOS REQUERIDOS

F		04
O		02



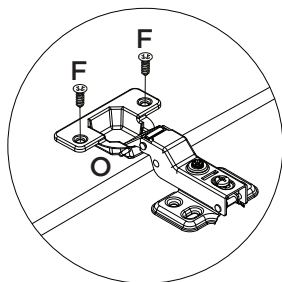
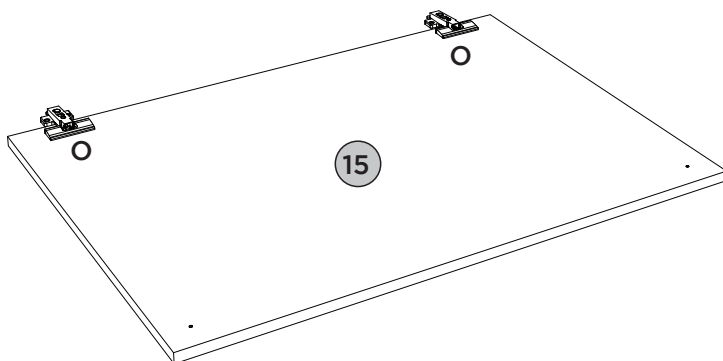
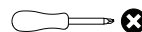

## FERRAMENTAS NECESSÁRIAS

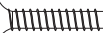

## PEÇAS REQUERIDAS

15	PORTA	x1
----	-------	----

## ACESSÓRIOS REQUERIDOS

C			01
F			08
N			01

## FERRAMENTAS NECESSÁRIAS

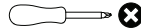

Para porta (15): Defina para o modo de perfuração.

Faça a furação passante para fixar o puxador (N).

### Opção 1 Opción 1 Option 1

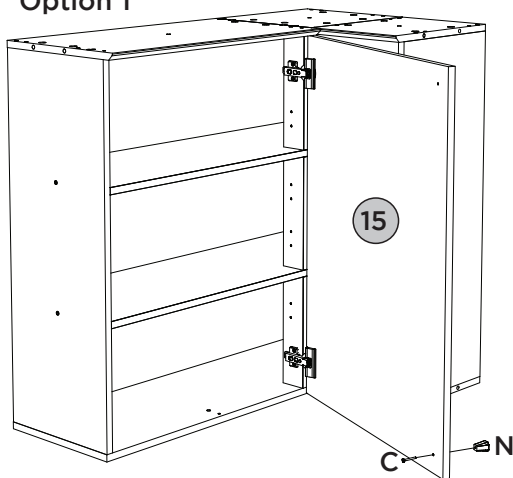

### Opção 2 Opción 2 Option 2

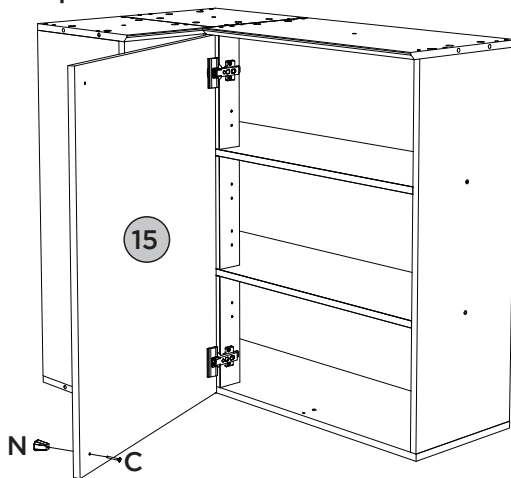
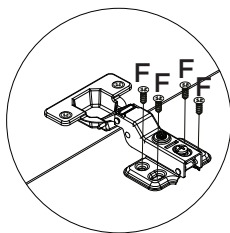

ACESSÓRIOS REQUERIDOS

A		03
F		06
P		03
Q		03
R		03
S		30
T		02

FERRAMENTAS NECESSÁRIAS



OU

Para parede: Ajustar no modo perfuração  
Para peças (2, 3 e 9): Usar torque 5

Pesos máximos recomendados com carga distribuída  
Peso máximo recomendado con la carga distribuida  
Recommended maximum weight with distributed load.

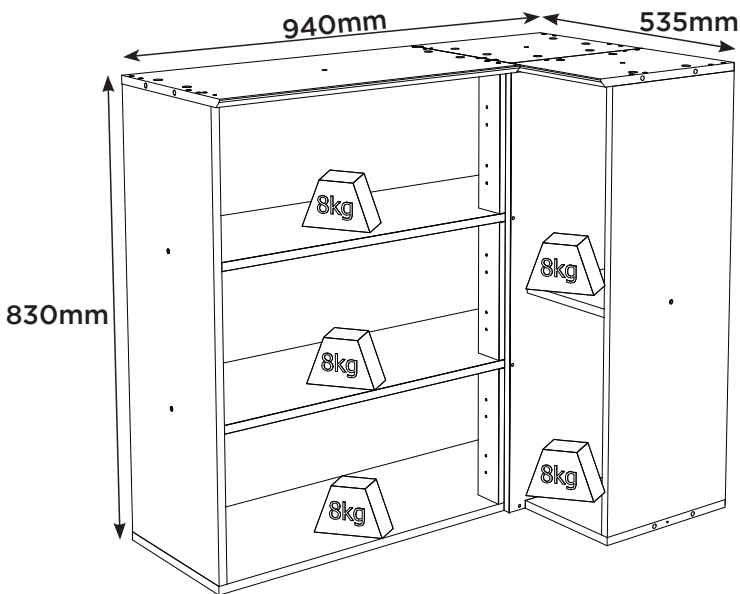

PERFECT CORRECTION  
CORRECCIÓN PERFECTA

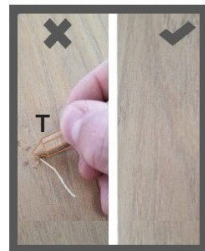

RECOMENDAÇÃO

Para fixar o móvel na parede usar o suporte de fixação (Q), o parafuso 4,0x14mm CHT (F), a Bucha 8mm (P) e o parafuso 5,0x50mm FLA (A).

RECOMENDACIÓN

Para conectar el móvil a la pared con el soporte (Q), tornillo 4,0x14mm CHT (F), el casquillo de 8 mm (P) y el 5,0 x50mm tornillo FLA (A).

RECOMMENDATION

To fix the furniture to the wall use the fixing bracket (Q), the 4,0x14mm CHT (F) screw, the 8mm bushing (P) and the 5.0x50mm FLA screw (A).

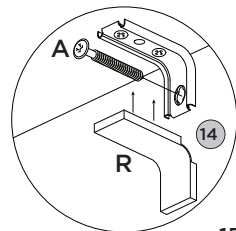
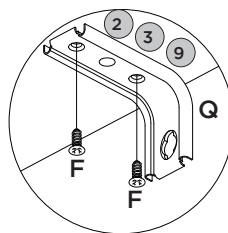
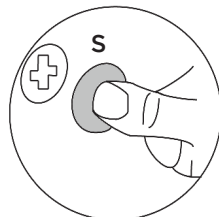

**Produto Concluído**  
**Producto terminado**  
**Finished Product**

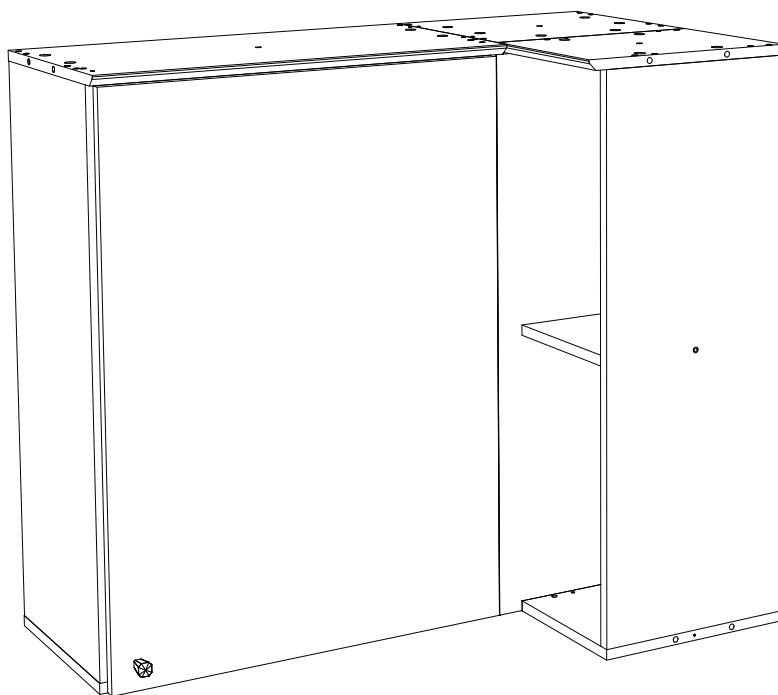

**HENN**Ind. e Com. de Móveis Henn  
Mondai - SC - Brasil

☎ +55 49 3674.3500

📱 @moveishenn  
www.henn.com.br**INSTRUÇÕES DE  
MONTAGEM**INSTRUCCIONES DE MONTAJE  
ASSEMBLY INSTRUCTIONS**Aéreo 01 Porta 400mm Requite |  
Aéreo 01 Puerta 400mm Requite |  
Aerial 01 Door 400mm Requite**

C635-128 Nature

C635-217 Nature/Areia HP

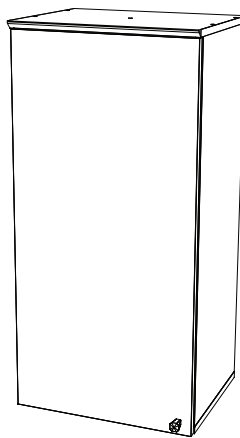
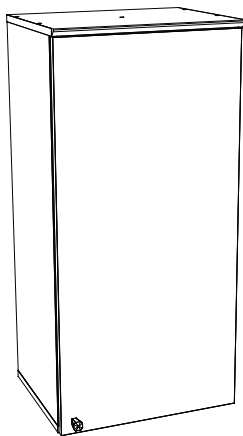
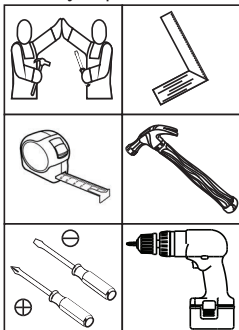
Opção 01  
Opción 01  
Option 01Opção 02  
Opción 02  
Option 02**Requisitos para montagem  
Requisitos para la montaje  
Assembly Requirements**

Imagens meramente ilustrativas,  
não acompanha o produto.  
Imágenes ilustrativas, no incluidas  
con el producto.  
Illustrative images, not included  
with the product.

**AVISO**

Para limpeza de seu móvel, use uma flanela seca ou umedecida, e não utilize produtos químicos que possam danificar seu produto.

**SISTEMA DE MONTAGEM**

O sistema de montagem dos produtos, funciona de acordo com a ordem crescente dos números indicados no desenho. Ex: 01, 02, 03, 04... até a conclusão da montagem.

**ASSISTÊNCIA TÉCNICA**

Para solicitação de Assistência Técnica você consumidor deverá entrar em contato com o Lojista o qual você realizou a compra deste produto e solicitar a assistência técnica das peças avariadas. A garantia abrange todas as peças, partes e componentes que eventualmente venham apresentar defeito de fabricação no prazo de 03 (três) meses, contando a partir da entrega do produto ao consumidor, mediante nota fiscal de compra. Se houver qualquer alteração na estrutura do produto ou ocorrer defeito por negligência do montador/consumidor em relação a instrução de montagem e manuseio, não será fornecido assistência técnica gratuita.

**ADVERTENCIA**

Para limpieza de su móvil, use una flanela seca o húmeda, y no utilice productos químicos que puedan dañar su producto.

**SISTEMA DE MONTAJE**

El sistema de montaje de los productos funciona de acuerdo con el orden creciente de los números indicados en el dibujo. Ej.: 01, 02, 03, 04... hasta la conclusión del montaje.

**ASISTENCIA TÉCNICA**

Para solicitar Asistencia Técnica, el consumidor debe comunicarse con el Comercio que usted realizó la compra de este producto y solicita asistencia técnica para las partes dañadas. La garantía cubre todas las partes, piezas y componentes que eventualmente puedan presentar defecto de fabricación en el plazo de 03 (tres) meses, contados a partir de la entrega del producto al consumidor, mediante factura de compra. Si se produce algún cambio en la estructura del producto o se produce un defecto por negligencia del montador/consumidor en relación con las instrucciones de montaje y manipulación, no se prestará asistencia técnica gratuita.

**NOTICE**

To clean your furniture, use a dry or wet cloth, and do not use chemicals that may damage your product.

**ASSEMBLY SYSTEM**

The products' assembly system works according to the increasing order of the indicated numbers. For example: 01, 02, 03, 04 ... to the end of the assembly.

**TECHNICAL ASSISTANCE**

To request Technical Assistance, the consumer must contact the retailer from whom you purchased this product and request technical assistance for the damaged parts. The warranty covers all parts, parts and components that may eventually present a manufacturing defect within a period of 03 (three) months, counting from the delivery of the product to the consumer, by means of a purchase invoice. If there is any change in the structure of the product or defect occurs due to negligence of the assembler/consumer in relation to the assembly and handling instruction, free technical assistance will not be provided.

## ACESSÓRIOS | ACCESORIOS | ACCESSORIES

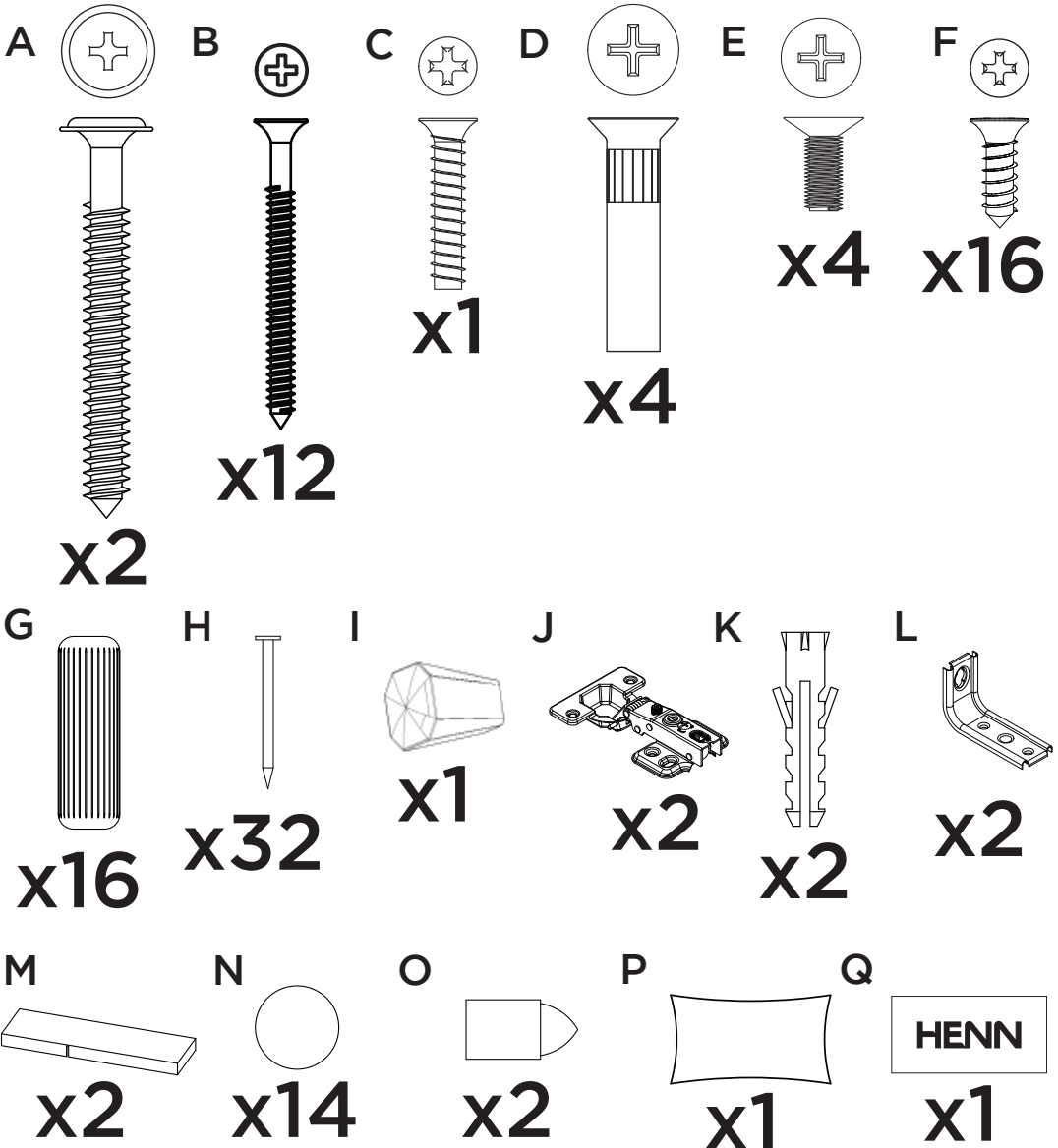

 Os parafusos (D/E) devem ser usados somente quando este módulo for acoplado a outro módulo componível Henn.

 Los tornillos (D/E) se debe utilizar sólo cuando el módulo está conectado a otro módulo componible Henn.

 Screws (D/E) are to be used only when this module is mated to another Henn buildable module.

Parafusos em escala  
Tornillos escalados  
Scaled screws

1:1

# LISTA DE PEÇAS | LISTA DE PIEZAS | LIST OF PIECES

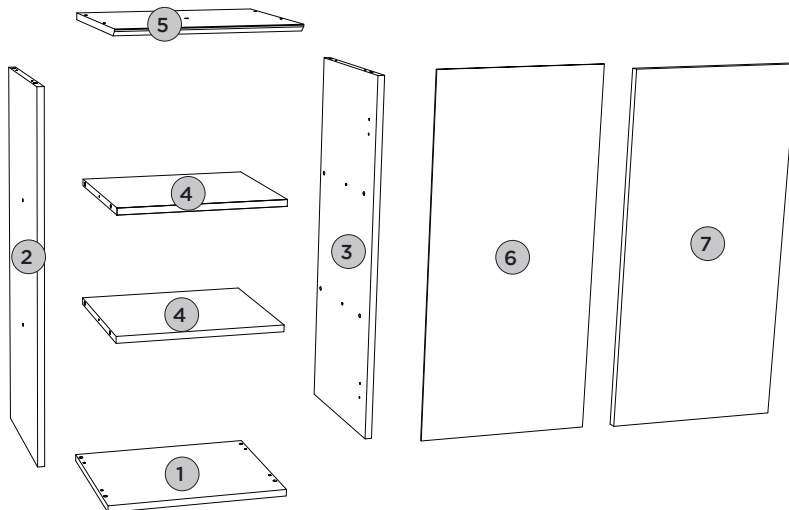

Item	Caixa Caja Box	Qty Ctd Qty	Descrição Descripción Description	Dimensões (mm)   Dimensiones (mm)		
				Comprimento Largo Length	Largura Ancho Width	Espessura Grosor Thickness
1	1/1	01	BASE   BASE   BASE	400	295	15
2	1/1	01	LATERAL ESQUERDA   LATERAL IZQUIERDA   LEFT SIDE	800	295	15
3	1/1	01	LATERAL DIREITA   LATERAL DERECHA   RIGHT SIDE	800	295	15
4	1/1	02	PRATELEIRA   ESTANTE   SHELF	369	295	15
5	1/1	01	TAMPO   TAPA   TOP	400	322	15
6	1/1	01	FUNDO   FONDO   BACKGROUND	824	392	3
7	1/1	01	PORTA   PUERTA   DOOR	813	396	15



# PASSO 1

ITM/C635-

## PEÇAS REQUERIDAS

2	LATERAL ESQUERDA	x1
3	LATERAL DIREITA	x1
4	PRATELEIRA	x2

## ACESSÓRIOS REQUERIDOS

G		16
P		

## FERRAMENTAS NECESSÁRIAS

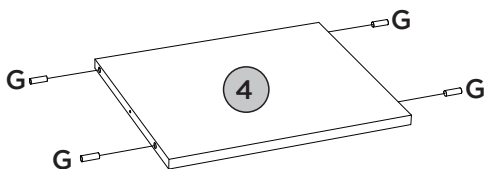
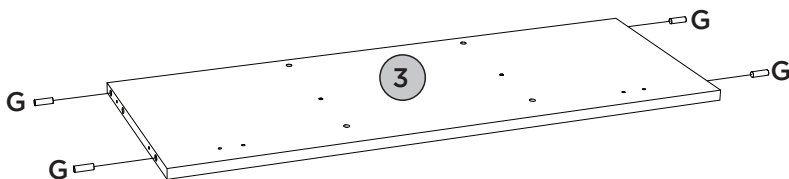
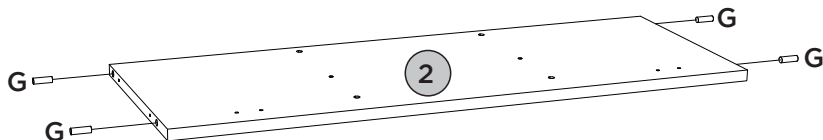
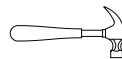

Utilizar o sachê de cola (P) em todas as cavilhas (G) do produto.

Con el pegamento sobre (P) en todos los pernos (G) producto.



Use the glue sachet (P) on all the pegs (G) of the product.



**PASSO 2****PEÇAS REQUERIDAS**

1	BASE	x1
2	LATERAL ESQUERDA	x1
3	LATERAL DIREITA	x1
4	PRATELEIRA	x2
5	TAMPO	x1

**ACESSÓRIOS REQUERIDOS**

B		12
P		

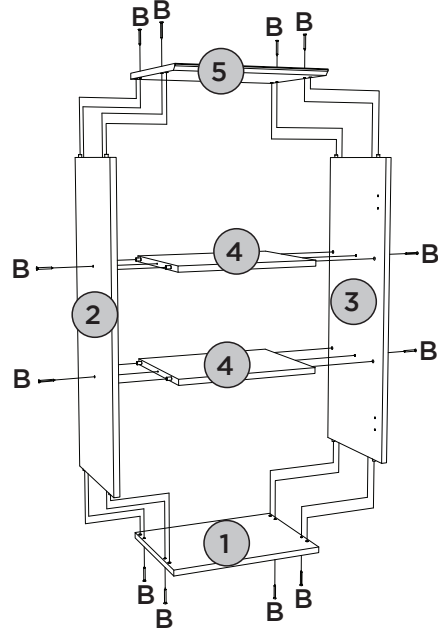
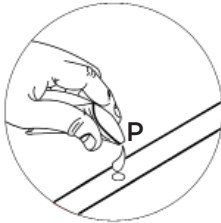
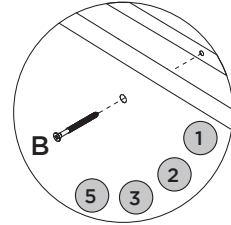
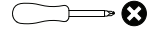
**FERRAMENTAS NECESSÁRIAS****PASSO 3****PEÇAS REQUERIDAS**

6	FUNDO	x1
---	-------	----

**ACESSÓRIOS REQUERIDOS**

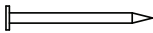
H		32
---	---	----

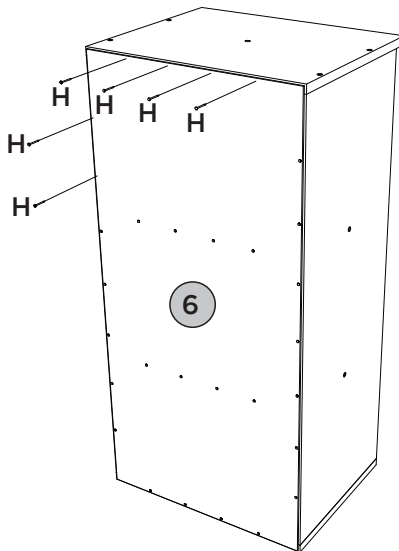
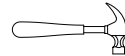
**FERRAMENTAS NECESSÁRIAS**

Fixar os pregos a uma distância de 100mm de um para outro.

Fijar las uñas a un distancia de 100mm uno a otro.

Fix the nails at a distance of 100mm from one to the other

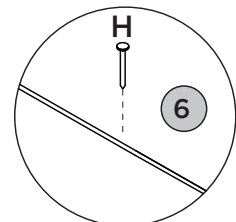



# PASSO 4

ITM/C635-

## PEÇAS REQUERIDAS

7	PORTA	x1
---	-------	----

## ACESSÓRIOS REQUERIDOS

F	 	04
J		02

## FERRAMENTAS NECESSÁRIAS

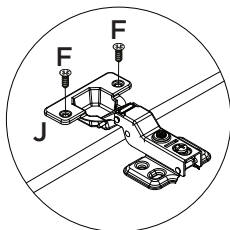
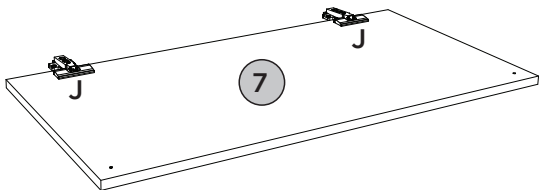
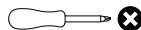





# PASSO 5

## PEÇAS REQUERIDAS

7	PORTA	x1
---	-------	----

## ACESSÓRIOS REQUERIDOS

C	 	01
F	 	08
I		01

## FERRAMENTAS NECESSÁRIAS

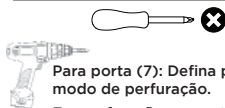

Para porta (7): Defina para o modo de perfuração.

Faça a furação passante para fixar os puxadores (I).

Opção 01  
Opción 01  
Option 01

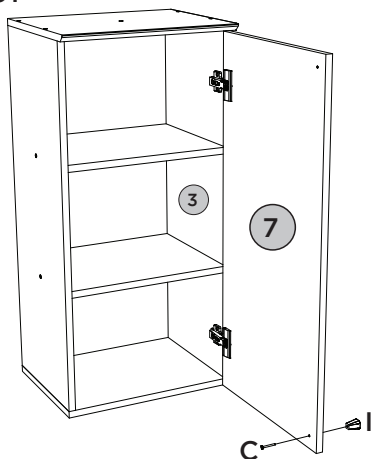

Opção 02  
Opción 02  
Option 02

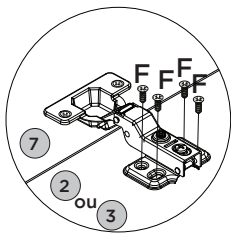
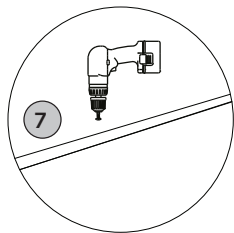
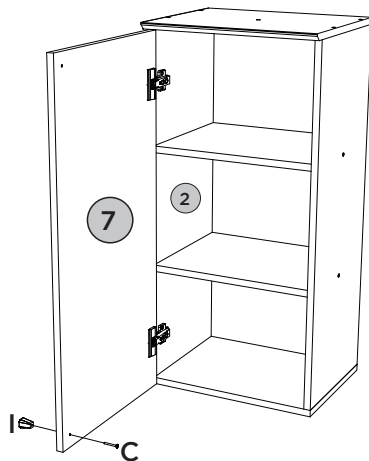

ACESSÓRIOS REQUERIDOS

A		02
F		04
K		02
L		02
M		02
N		14
O		02
Q		01

FERRAMENTAS NECESSÁRIAS



OU

Para parede: Ajustar no modo perfuração  
Para peça (02 e 03): Usar torque 5.

Pesos máximos recomendados com carga distribuída  
Peso máximo recomendado con la carga distribuida  
Recommended maximum weight with distributed load.

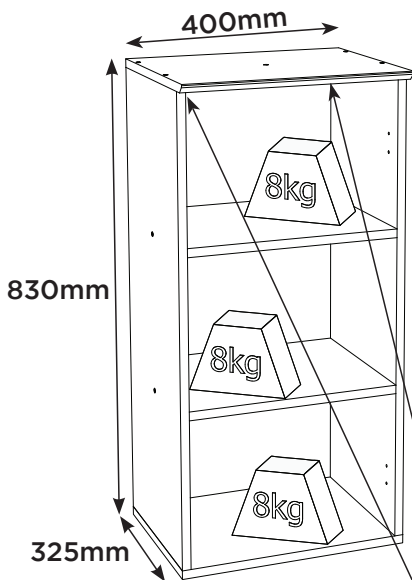

PERFECT CORRECTION  
CORRECCIÓN PERFECTA

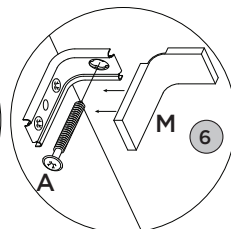
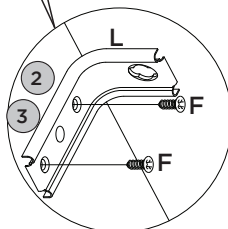
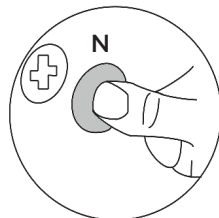
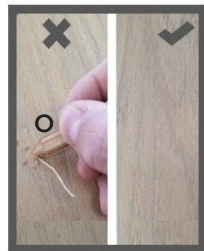

RECOMENDAÇÃO

Para fixar o móvel na parede usar o suporte de fixação (L), o parafuso 4,0x14mm CHT (F), a Bucha 8mm (K) e o parafuso 5,0x50mm FLA (A).

RECOMENDACIÓN

Para conectar el móvil a la pared con el soporte (L), tornillo 4,0x14mm CHT (F), el casquillo de 8 mm (K) y el 5,0 x50mm tornillo FLA (A).

RECOMMENDATION

To fix the furniture to the wall use the fixing bracket (L), the 4,0x14mm CHT (F) screw, the 8mm bushing (K) and the 5,0x50mm FLA screw (A).

**Produto Concluído**  
**Producto terminado**  
**Finished Product**

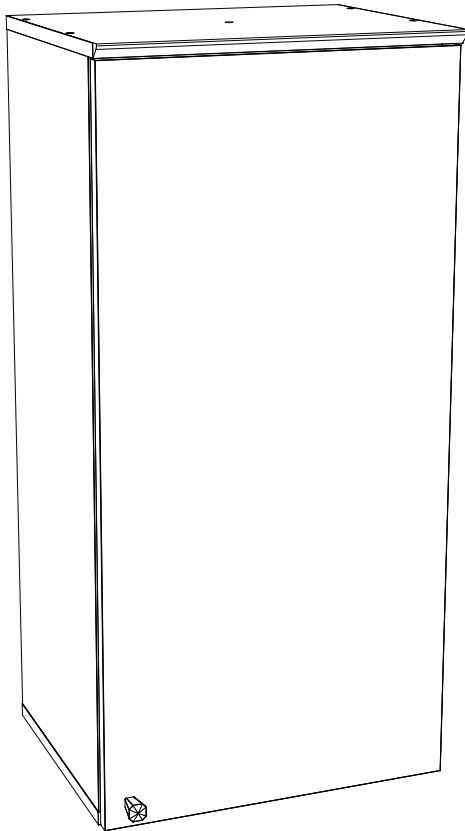
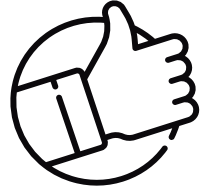

**HENN**Ind. e Com. de Móveis Henn  
Mondai - SC - Brasil

☎ +55 49 3674.3500

📧 @moveishenn  
www.henn.com.br**INSTRUÇÕES DE  
MONTAGEM**INSTRUCCIONES DE MONTAJE  
ASSEMBLY INSTRUCTIONS**Balcão 01 Porta 400mm Requite |**  
**Contador 01 Puerta 400mm Requite | Counter 01 Door 400mm Requite**

C638-217 Nature/Areia HP

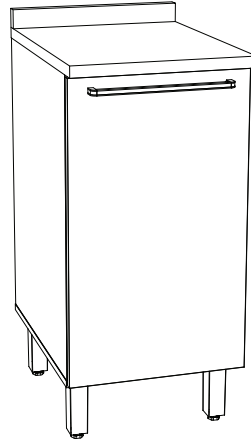
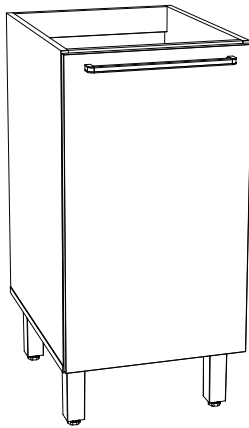
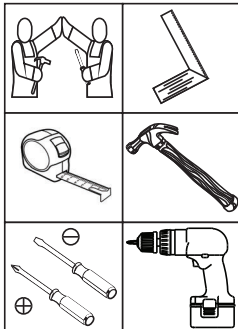
**Opção**  
**Opción**  
**Option****Requisitos para montagem**  
**Requisitos para la montaje**  
**Assembly Requirements**

Imagens meramente ilustrativas,  
não acompanha o produto.  
Imágenes ilustrativas, no incluidas  
con el producto.  
Illustrative images, not included  
with the product.

**AVISO**

Para limpeza de seu móvel, use uma franela seca ou umedecida, e não utilize produtos químicos que possam danificar seu produto.

**SISTEMA DE MONTAGEM**

O sistema de montagem dos produtos, funciona de acordo com a ordem crescente dos números indicados no desenho. Ex: 01, 02, 03, 04... até a conclusão da montagem.

**ASSISTÊNCIA TÉCNICA**

Para solicitação de Assistência Técnica você consumidor deverá entrar em contato com o Lojista o qual você realizou a compra deste produto e solicitar a assistência técnica das peças avariadas. A garantia abrange todas as peças, partes e componentes que eventualmente venham apresentar defeito de fabricação no prazo de 03 (três) meses, contando a partir da entrega do produto ao consumidor, mediante nota fiscal de compra. Se houver qualquer alteração na estrutura do produto ou ocorrer defeito por negligência do montador/consumidor em relação a instrução de montagem e manuseio, não será fornecido assistência técnica gratuita.

**ADVERTENCIA**

Para limpieza de su móvil, use una franela seca o húmeda, y no utilice productos químicos que puedan dañar su producto.

**SISTEMA DE MONTAJE**

El sistema de montaje de los productos funciona de acuerdo con el orden creciente de los números indicados en el dibujo. Ej.: 01, 02, 03, 04... hasta la conclusión del montaje.

**ASSISTÊNCIA TÉCNICA**

Para solicitar Assistência Técnica, o consumidor deve comunicar-se com o Comercio que usted realizou a compra de este produto y solicita asistencia técnica para las partes dañadas. La garantía cubre todas las partes, piezas y componentes que eventualmente puedan presentar defecto de fabricación en el plazo de 03 (tres) meses, contados a partir de la entrega del producto al consumidor, mediante factura de compra. Si se produce algún cambio en la estructura del producto o se produce un defecto por negligencia del montador/consumidor en relación con las instrucciones de montaje y manipulación, no se prestará asistencia técnica gratuita.

**NOTICE**

To clean your furniture, use a dry or wet cloth, and do not use chemicals that may damage your product.

**ASSEMBLY SYSTEM**

The products' assembly system works according to the increasing order of the indicated numbers. For example: 01, 02, 03, 04 ... to the end of the assembly.

**TECHNICAL ASSISTANCE**

To request Technical Assistance, the consumer must contact the retailer from whom you purchased this product and request technical assistance for the damaged parts. The warranty covers all parts, parts and components that may eventually present a manufacturing defect within a period of 03 (three) months, counting from the delivery of the product to the consumer, by means of a purchase invoice. If there is any change in the structure of the product or defect occurs due to negligence of the assembler/consumer in relation to the assembly and handling instruction, free technical assistance will not be provided.

# ACESSÓRIOS | ACCESORIOS | ACCESSORIES

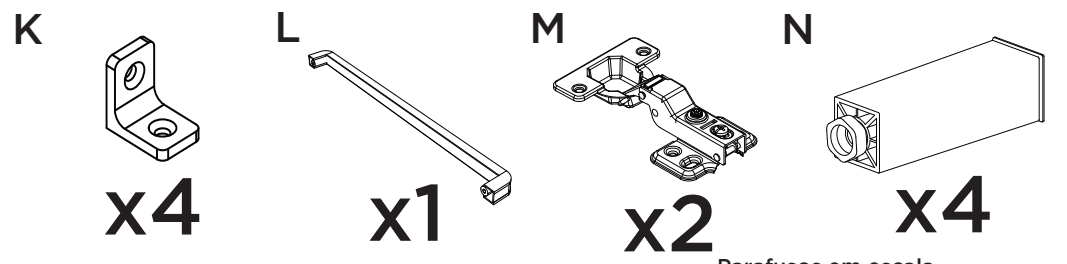
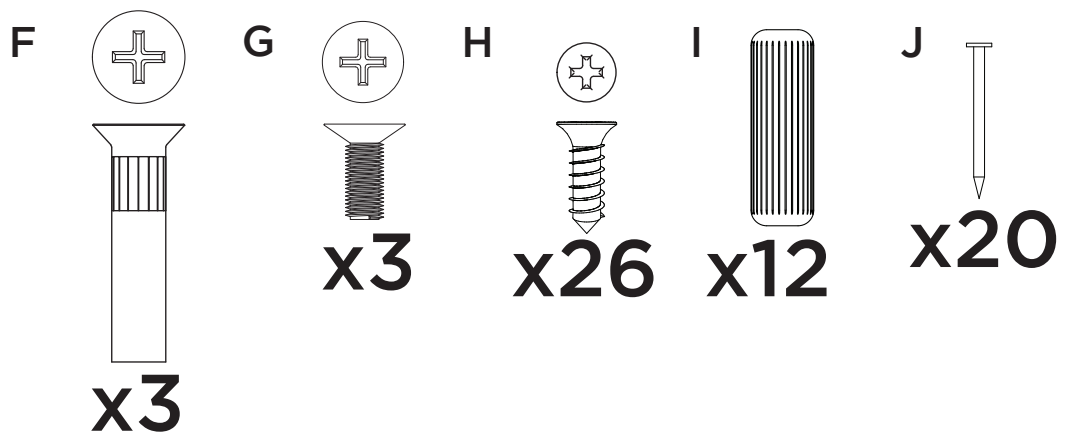
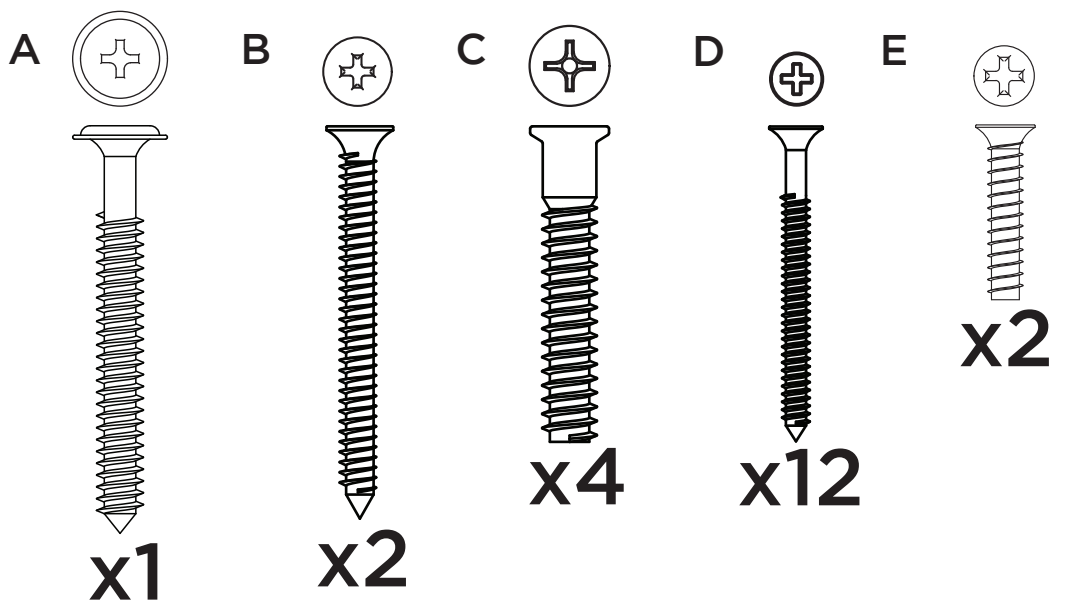

Parafusos em escala  
 Tornillos escalados  
 Scaled screws **1:1**

# ACESSÓRIOS | ACCESORIOS | ACCESSORIES

O

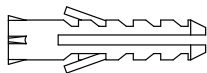

**x1**

P

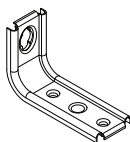

**x1**

Q

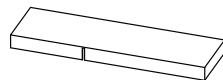

**x1**

R

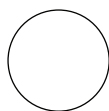

**x14**

S

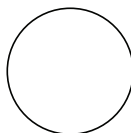

**x4**

T

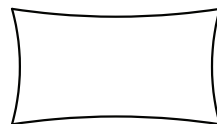

**x1**



Os parafusos (F/G) devem ser usados somente quando este módulo for acoplado a outro módulo componível Henn.



Los tornillos (F/G) se debe utilizar sólo cuando el módulo está conectado a otro módulo componible Henn.



Screws (F/G) are to be used only when this module is mated to another Henn buildable module.

## LISTA DE PEÇAS | LISTA DE PIEZAS | LIST OF PIECES

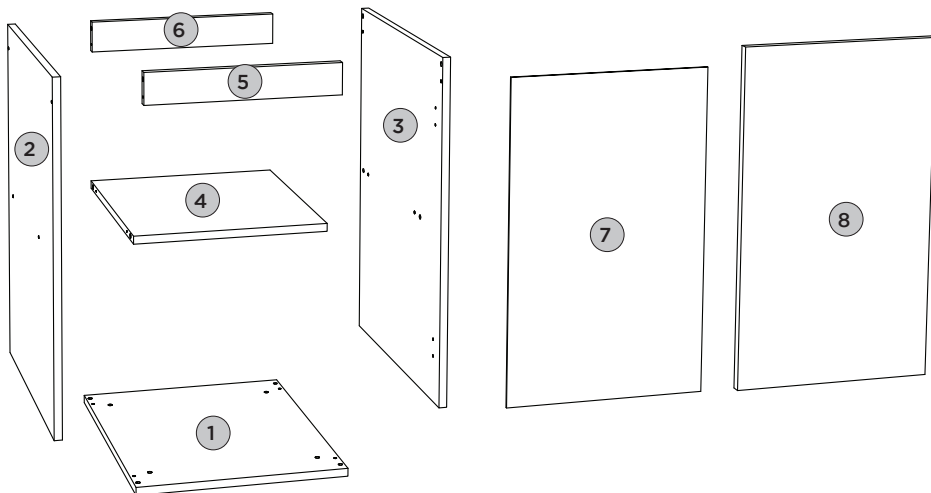

Item	Caixa Caja Box	Qty Ctd Qty	Descrição Descripción Description	Dimensões (mm)   Dimensiones (mm)   Dimensions (mm)		
				Comprimento Largo Length	Largura Ancho Width	Espessura Grosor Thickness
1	1/1	01	BASE   BASE   BASE	490	400	15
2	1/1	01	LATERAL ESQUERDA   LATERAL IZQUIERDA   LEFT SIDE	660	490	15
3	1/1	01	LATERAL DIREITA   LATERAL DERECHA   RIGHT SIDE	660	490	15
4	1/1	01	PRATELEIRA   ESTANTE   SHELF	400	368	15
5	1/1	01	TRAVESSA FRONTAL   TRAVESAÑO FRONTAL   FRONT CROSSBAR	368	60	15
6	1/1	01	TRAVESSA TRASEIRA   TRAVESAÑO TRASERO   REAR BUMPER	368	60	15
7	1/1	01	FUNDO   FONDO   BOTTOM	627	392	3
8	1/1	01	PORTA   PUERTA   DOOR	665	396	15







# PASSO 1

ITM/C638-

## PEÇAS REQUERIDAS

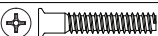
1	BASE	x1
2	LATERAL ESQUERDA	x1
3	LATERAL DIREITA	x1
4	PRATELEIRA	x1
5	TRAVESSA FRONTAL	x1
6	TRAVESSA TRASEIRA	x1

## ACESSÓRIOS REQUERIDOS

C		04
I		12
N		04
T		

## FERRAMENTAS NECESSÁRIAS

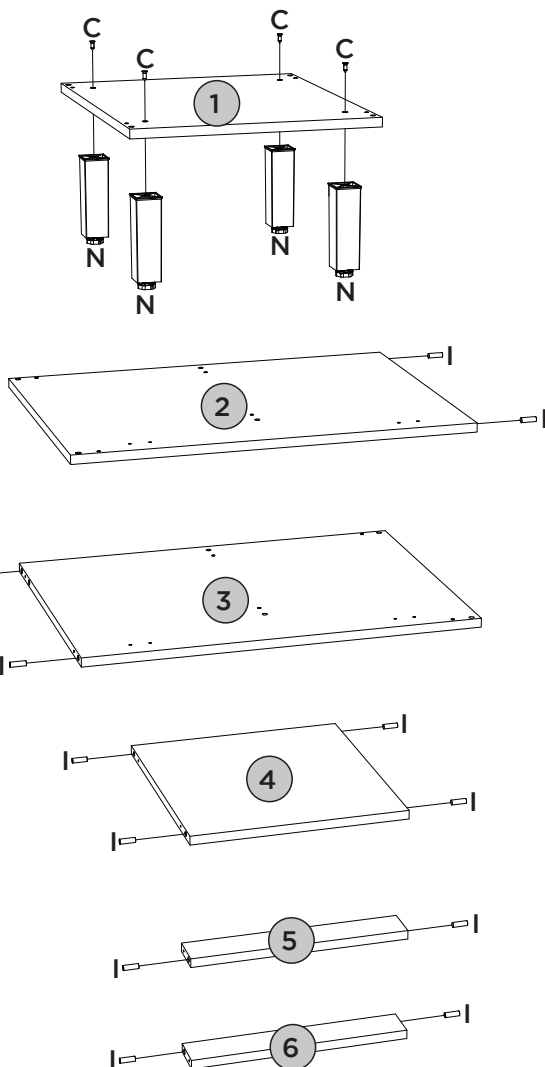
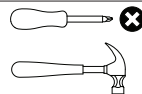

Utilizar o sachê de cola (T) em todas as cavilhas (I) do produto.



Con el pegamento sobre (T) en todos los pernos (I) producto.

Use the glue sachet (T) on all the pegs (I) of the product.

**PASSO 2****PEÇAS REQUERIDAS**





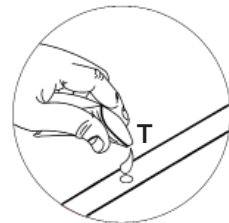
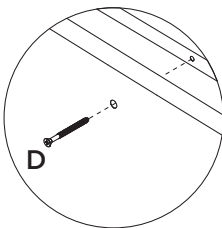
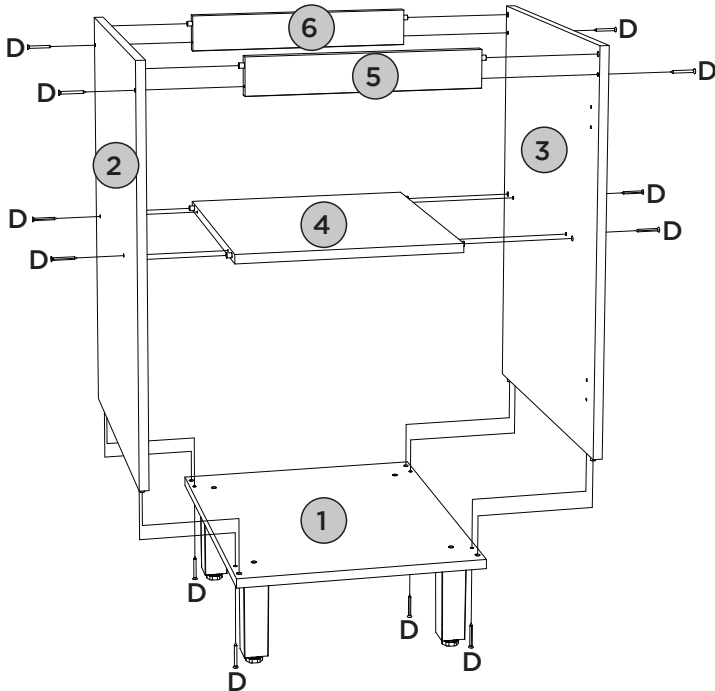

1	BASE	x1
2	LATERAL ESQUERDA	x1
3	LATERAL DIREITA	x1
4	PRATELEIRA	x1
5	TRAVESSA FRONTAL	x1
6	TRAVESSA TRASEIRA	x1

**ACESSÓRIOS REQUERIDOS**

D			12
T			

**FERRAMENTAS NECESSÁRIAS**

## ACESSÓRIOS REQUERIDOS

B			02
H			08
K			04

## FERRAMENTAS NECESSÁRIAS

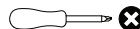

Esse tampo é opcional e é vendido separadamente (C902-128).

Esta vez es opcional y se vende por separado (C902-128).

This top is optional and is sold separately (C902-128).

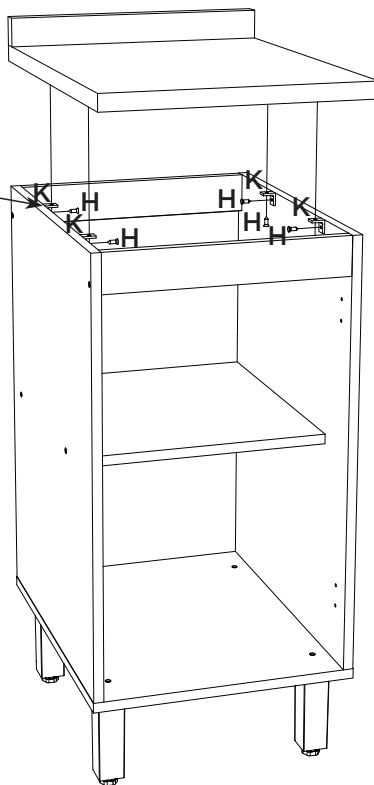
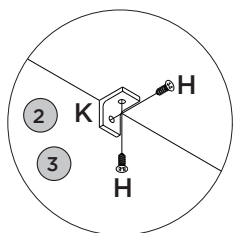
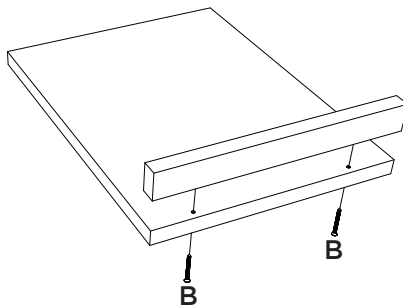

# PASSO 4

ITM/C638-

## PEÇAS REQUERIDAS

7	FUNDO	x1
---	-------	----

## ACESSÓRIOS REQUERIDOS

H		04
J		20

## FERRAMENTAS NECESSÁRIAS

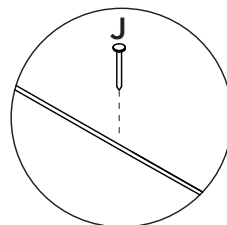
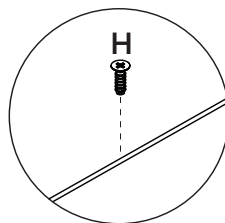
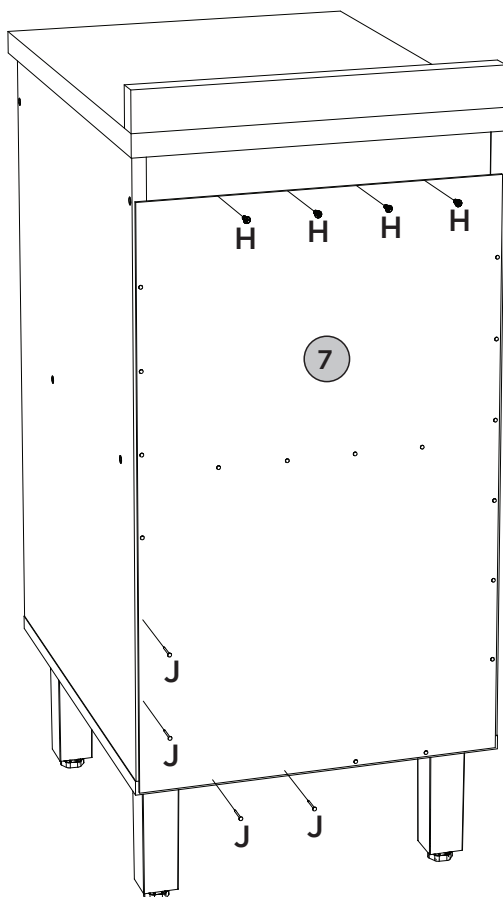
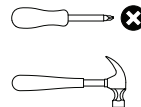

Fixar os pregos a uma distância de 100mm de um para outro.



Fijar las uñas a un distancia de 100mm uno a otro.

Fix the nails at a distance of 100mm from one to the other

## PEÇAS REQUERIDAS

8	PORTA	x1
---	-------	----

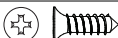
## ACESSÓRIOS REQUERIDOS

H		04
M		02



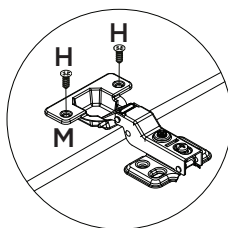
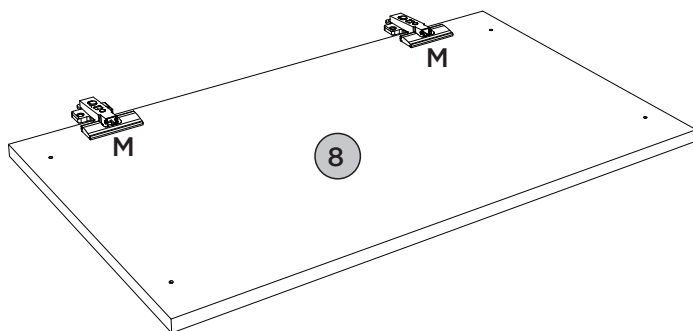
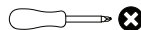

## FERRAMENTAS NECESSÁRIAS



## PEÇAS REQUERIDAS

8	PORTA	x1
---	-------	----

## ACESSÓRIOS REQUERIDOS

E	 	02
H	 	08
L		01

## FERRAMENTAS NECESSÁRIAS

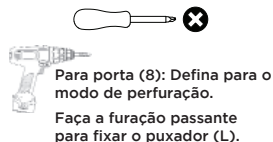

Opção 01  
Opción 01  
Option 01

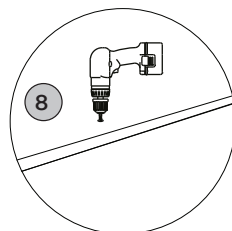
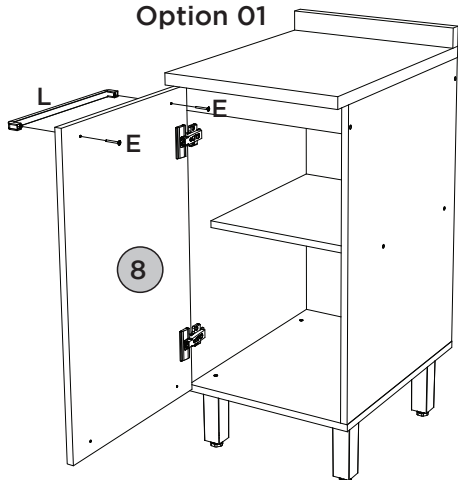

Opção 02  
Opción 02  
Option 02

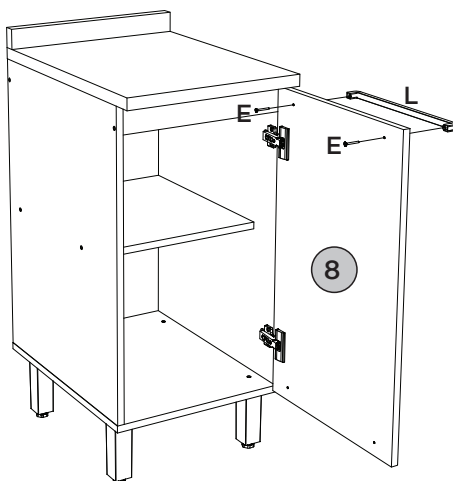
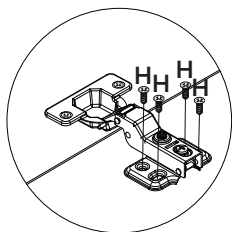

## ACESSÓRIOS REQUERIDOS

A		01
H		02
O		01
P		01

Q		01
R		14
S		04

## FERRAMENTAS NECESSÁRIAS

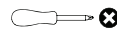

OU



Para parede: Ajustar no modo perfuração

**Pesos máximos recomendados com carga distribuída**  
**Peso máximo recomendado con la carga distribuida**  
**Recommended maximum weight with distributed load.**

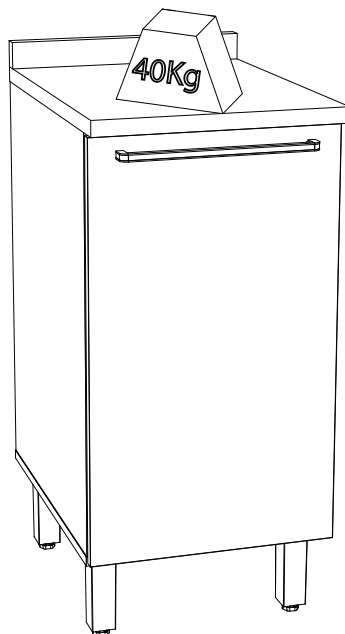
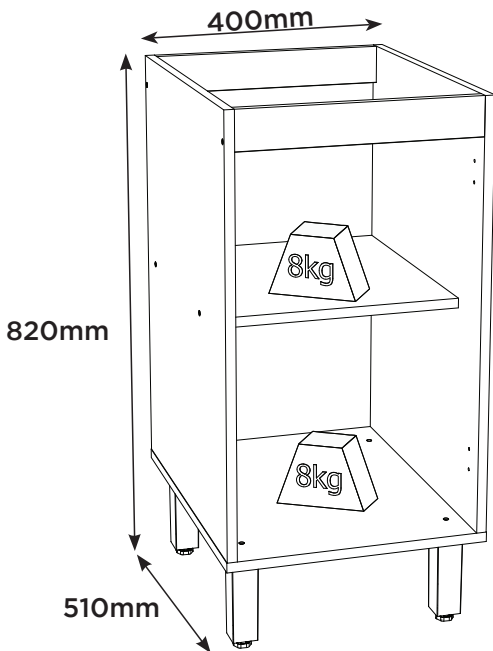

### RECOMENDAÇÃO

Para fixar o móvel na parede usar o suporte de fixação (P), o parafuso 4,0x14mm CHT (H), a Bucha 8mm (O) e o parafuso 5,0x50mm FLA (A).

### RECOMENDACIÓN

Para conectar el móvil a la pared con el soporte (P), tornillo 4,0x14mm CHT (H), el casquillo de 8 mm (O) y el 5,0 x50mm tornillo FLA (A).

### RECOMMENDATION

To fix the furniture to the wall use the fixing bracket (P), the 4,0x14mm CHT (H) screw, the 8mm bushing (O) and the 5.0x50mm FLA screw (A).

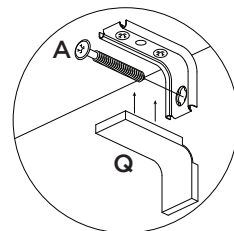
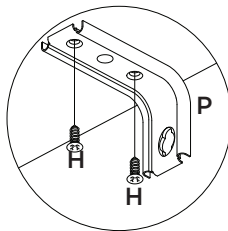
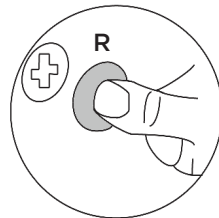
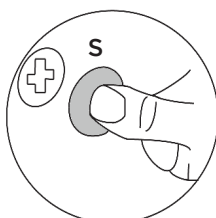

**Producto Concluído**  
**Producto terminado**  
**Finished Product**

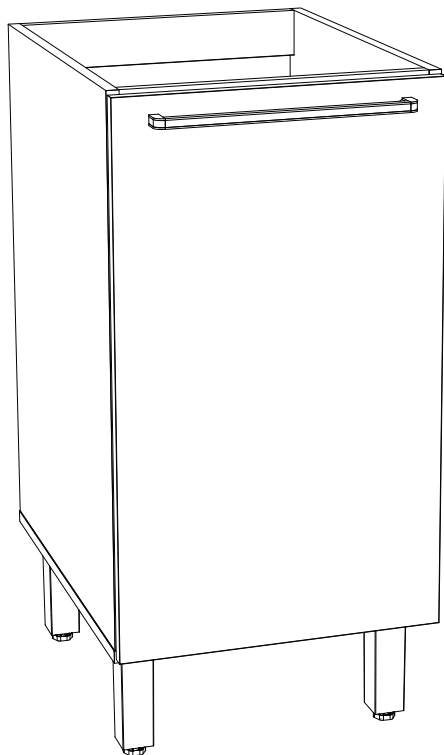



**HENN**Ind. e Com. de Móveis Henn  
Mondai - SC - Brasil

☎ +55 49 3674.3500

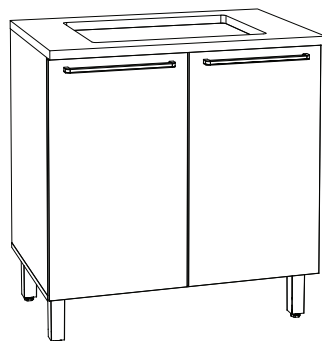
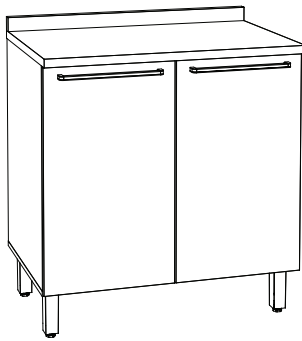
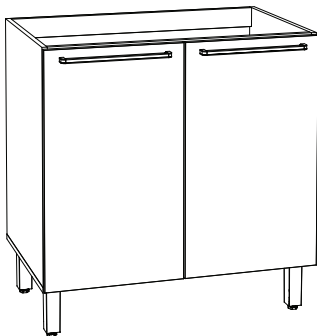
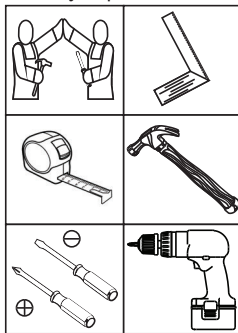
📧 @moveishenn  
www.henn.com.br**INSTRUÇÕES DE  
MONTAGEM**INSTRUCCIONES DE MONTAJE  
ASSEMBLY INSTRUCTIONS**Balcão 02 Portas 800mm Requite |****Contador 02 Puertas 800mm Requite | Counter 02 Doors 800mm Requite****C639-217 Nature/Areia HP****Opção 01****Opción 01****Option 01****Opção 02****Opción 02****Option 02****Requisitos para montagem  
Requisitos para la montaje  
Assembly Requirements**

Imagens meramente ilustrativas,  
não acompanha o produto.  
Imágenes ilustrativas, no incluidas  
con el producto.  
Illustrative images, not included  
with the product.

**AVISO**

Para limpeza de seu móvel, use uma franela seca ou umedecida, e não utilize produtos químicos que possam danificar seu produto.

**SISTEMA DE MONTAGEM**

O sistema de montagem dos produtos, funciona de acordo com a ordem crescente dos números indicados no desenho. Ex: 01, 02, 03, 04... até a conclusão da montagem.

**ASSISTÊNCIA TÉCNICA**

Para solicitação de Assistência Técnica você consumidor deverá entrar em contato com o Lojista a qual você realizou a compra deste produto e solicitar a assistência técnica das peças avariadas. A garantia abrange todas as peças, partes e componentes que eventualmente venham apresentar defeito de fabricação no prazo de 03 (três) meses, contando a partir da entrega do produto ao consumidor, mediante nota fiscal de compra. Se houver qualquer alteração na estrutura do produto ou ocorrer defeito por negligência do montador/consumidor em relação a instrução de montagem e manuseio, não será fornecido assistência técnica gratuita.

**ADVERTENCIA**

Para limpieza de su móvil, use una franela seca o húmeda, y no utilice productos químicos que puedan dañar su producto.

**SISTEMA DE MONTAJE**

El sistema de montaje de los productos funciona de acuerdo con el orden creciente de los números indicados en el dibujo. Ej.: 01, 02, 03, 04... hasta la conclusión del montaje.

**ASSISTÊNCIA TÉCNICA**

Para solicitar Asistencia Técnica, el consumidor debe comunicarse con el Comercio que usted realizó la compra de este producto y solicita asistencia técnica para las partes dañadas. La garantía cubre todas las partes, piezas y componentes que eventualmente puedan presentar defecto de fabricación en el plazo de 03 (tres) meses, contados a partir de la entrega del producto al consumidor, mediante factura de compra. Si se produce algún cambio en la estructura del producto o se produce un defecto por negligencia del montador/consumidor en relación con las instrucciones de montaje y manipulación, no se prestará asistencia técnica gratuita.

**NOTICE**

To clean your furniture, use a dry or wet cloth, and do not use chemicals that may damage your product.

**ASSEMBLY SYSTEM**

The products' assembly system works according to the increasing order of the indicated numbers. For example: 01, 02, 03, 04 ... to the end of the assembly.

**TECHNICAL ASSISTANCE**

To request Technical Assistance, the consumer must contact the retailer from whom you purchased this product and request technical assistance for the damaged parts. The warranty covers all parts, parts and components that may eventually present a manufacturing defect within a period of 03 (three) months, counting from the delivery of the product to the consumer, by means of a purchase invoice. If there is any change in the structure of the product or defect occurs due to negligence of the assembler/consumer in relation to the assembly and handling instruction, free technical assistance will not be provided.

# ACESSÓRIOS | ACCESORIOS | ACCESSORIES

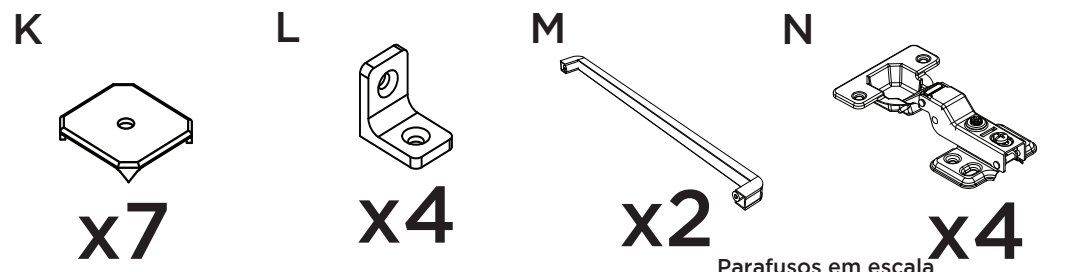
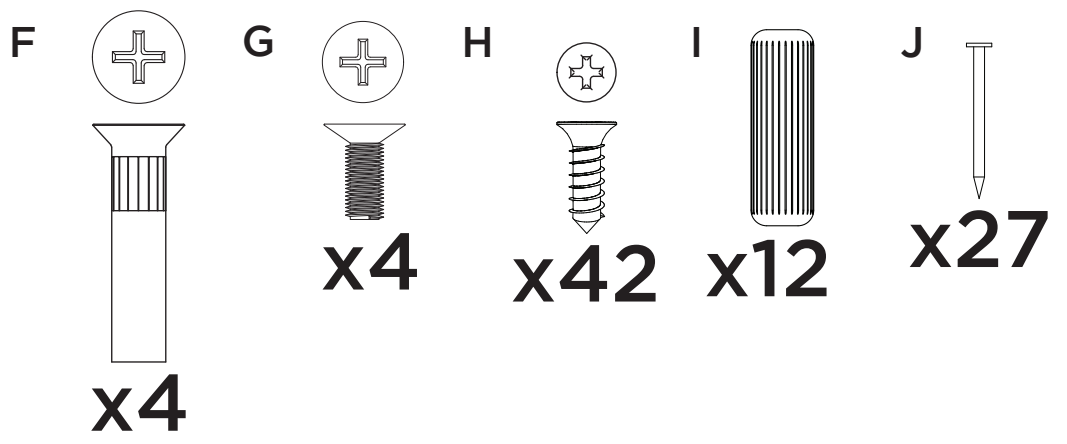
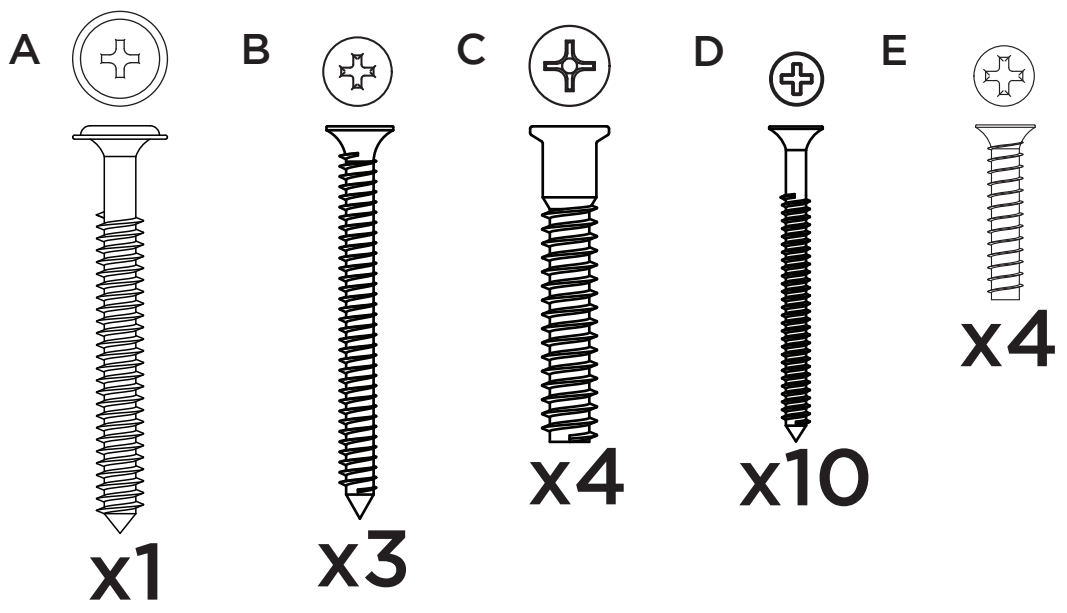

Parafusos em escala  
Tornillos escalados  
Scaled screws **1:1**

# ACESSÓRIOS | ACCESORIOS | ACCESSORIES

O

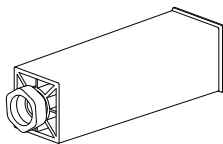

x4

P

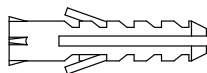

x1

Q

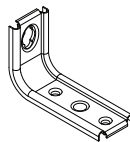

x1

R

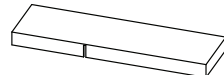

x1

S

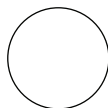

x14

T

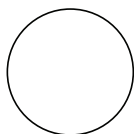

x4

U

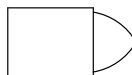

x3

V

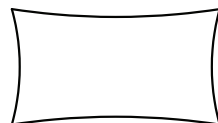

x1



Os parafusos (F/G) devem ser usados somente quando este módulo for acoplado a outro módulo componível Henn.



Los tornillos (F/G) se debe utilizar sólo cuando el módulo está conectado a otro módulo componible Henn.



Screws (F/G) are to be used only when this module is mated to another Henn buildable module.

## LISTA DE PEÇAS | LISTA DE PIEZAS | LIST OF PIECES

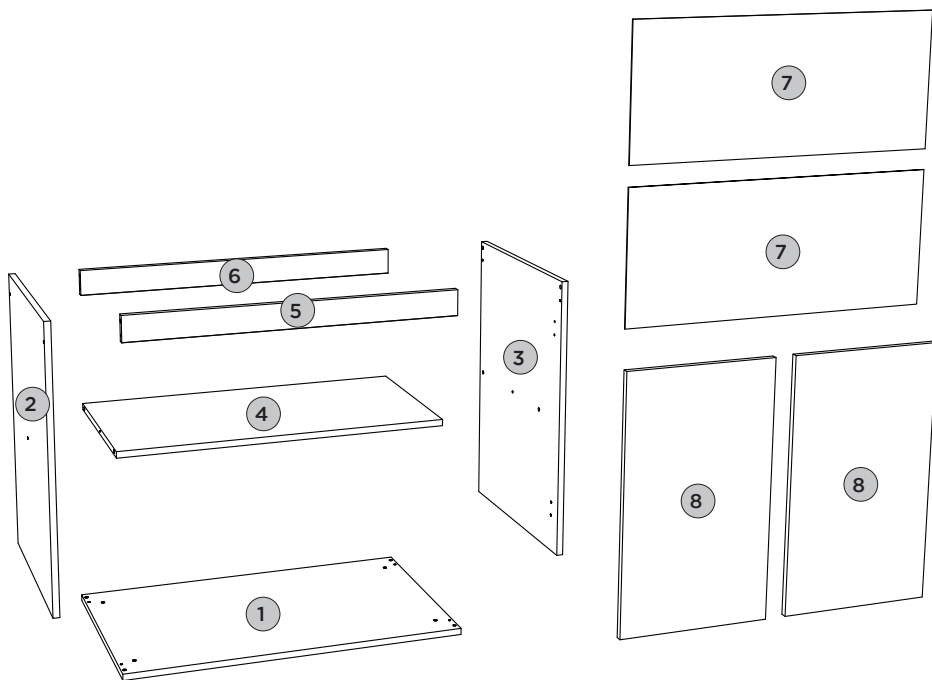





Item	Caixa Caja Box	Qtd Ctd Qty	Descrição Descripción Description	Dimensões (mm)   Dimensiones (mm)   Dimensions (mm)		
				Comprimento Largo Length	Largura Ancho Width	Espessura Grosor Thickness
1	1/1	01	BASE   BASE   BASE	800	490	15
2	1/1	01	LATERAL ESQUERDA   LATERAL IZQUIERDA   LEFT SIDE	660	490	15
3	1/1	01	LATERAL DIREITA   LATERAL DERECHA   RIGHT SIDE	660	490	15
4	1/1	01	PRATELEIRA   ESTANTE   SHELF	768	400	15
5	1/1	01	TRAVESSA FRONTAL   TRAVESAÑO FRONTAL   FRONT CROSSBAR	768	60	15
6	1/1	01	TRAVESSA TRASEIRA   TRAVESAÑO TRASERO   REAR BUMPER	768	60	15
7	1/1	02	FUNDO   FONDO   BOTTOM	792	335	3
8	1/1	02	PORTA   PUERTA   DOOR	665	396	15

## PEÇAS REQUERIDAS

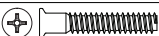
1	BASE	x1
2	LATERAL ESQUERDA	x1
3	LATERAL DIREITA	x1
4	PRATELEIRA	x1
5	TRAVESSA FRONTAL	x1
6	TRAVESSA TRASEIRA	x1

## ACESSÓRIOS REQUERIDOS

C		04
I		12
O		04
V		

## FERRAMENTAS NECESSÁRIAS

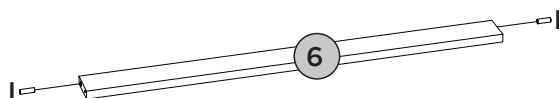
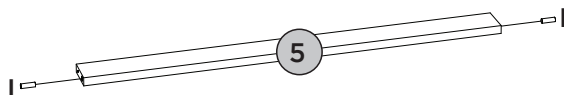
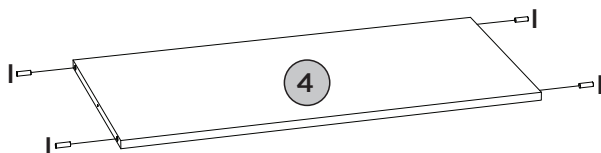
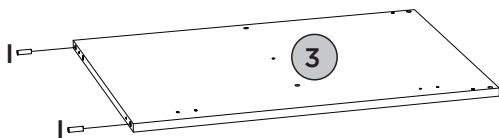
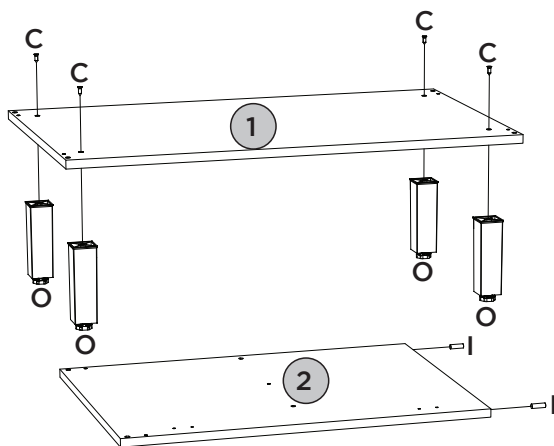
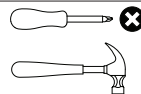

Utilizar o sachê de cola (V) em todas as cavilhas (I) do produto.

Con el pegamento sobre (V) en todos los pernos (I) producto.

Use the glue sachet (V) on all the pegs (I) of the product.



# PASSO 2

ITM/C639-

## PEÇAS REQUERIDAS

1	BASE	x1
2	LATERAL ESQUERDA	x1
3	LATERAL DIREITA	x1
4	PRATELEIRA	x1
5	TRAVESSA FRONTAL	x1
6	TRAVESSA TRASEIRA	x1



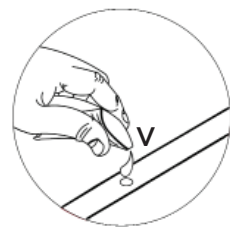
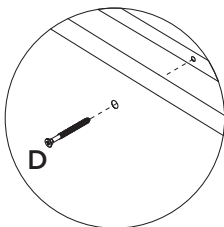
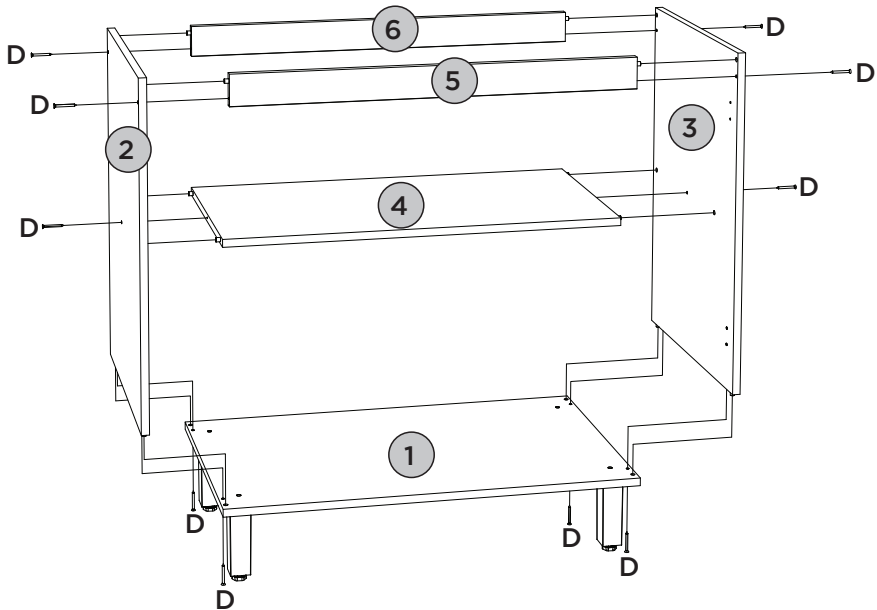

## ACESSÓRIOS REQUERIDOS

D			10
V			

## FERRAMENTAS NECESSÁRIAS



ACESSÓRIOS REQUERIDOS

B			03
H			08
L			04

FERRAMENTAS NECESSÁRIAS

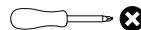

Esse tampo é opcional e é vendido separadamente (C904-128).

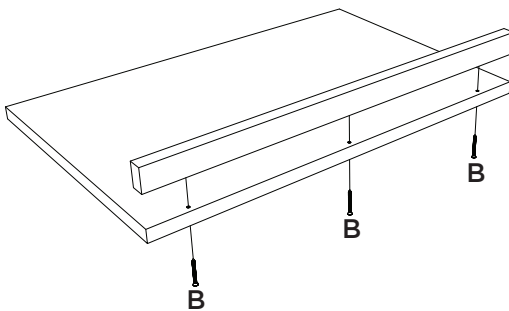



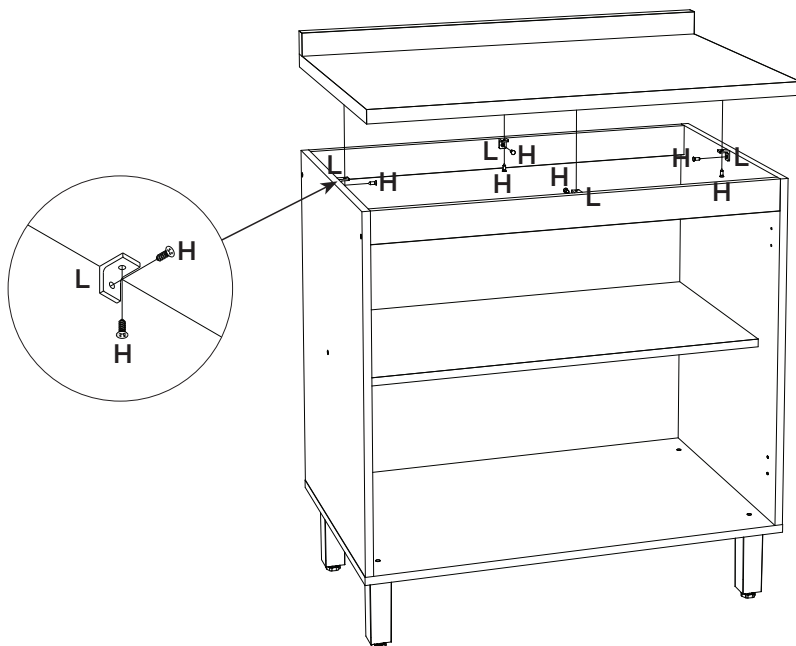

Esta vez es opcional y se vende por separado (C904-128).

This top is optional and is sold separately (C904-128).



## ACESSÓRIOS REQUERIDOS

H			08
L			04

## FERRAMENTAS NECESSÁRIAS

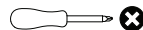

Esse tampo é opcional e é vendido separadamente (C908-128).

Esta vez es opcional y se vende por separado (C908-128).

This top is optional and is sold separately (C908-128).

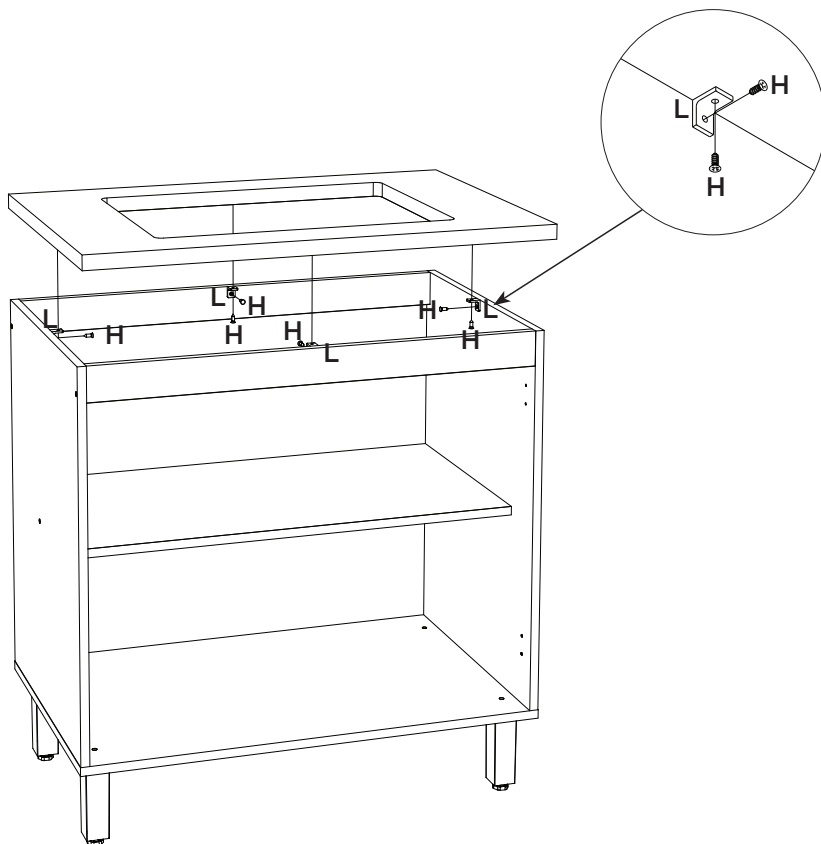





## PEÇAS REQUERIDAS

7	FUNDO	x2
---	-------	----

## ACESSÓRIOS REQUERIDOS

H		08
J		27
K		07

## FERRAMENTAS NECESSÁRIAS

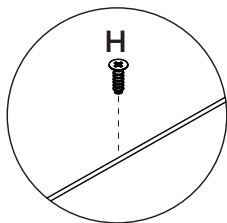
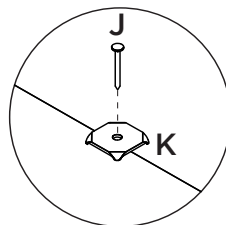
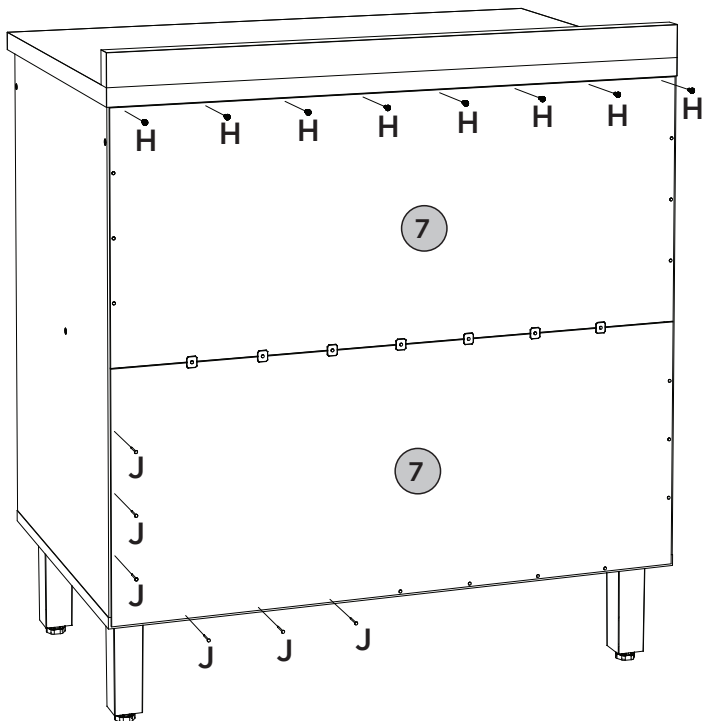
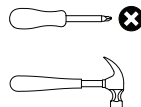

Fixar os pregos a uma distância de 100mm de um para outro.



Fijar las uñas a un distancia de 100mm uno a otro.

Fix the nails at a distance of 100mm from one to the other

**PASSO 6****PEÇAS REQUERIDAS**

8	PORTA	x2
---	-------	----

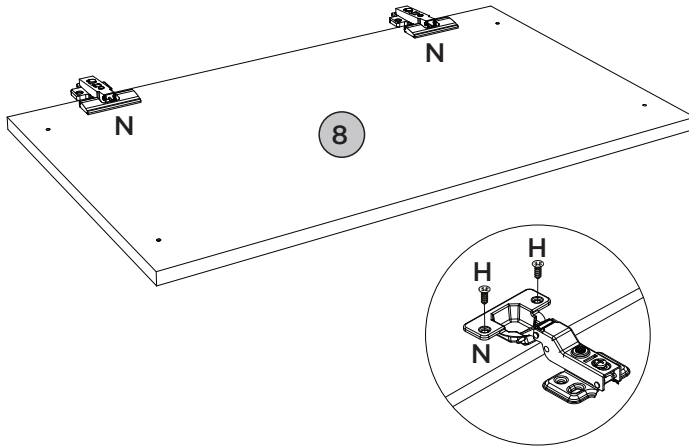
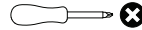

**ACESSÓRIOS REQUERIDOS**

H		08
N		04

**FERRAMENTAS NECESSÁRIAS****PASSO 7****PEÇAS REQUERIDAS**

8	PORTA	x2
---	-------	----

**ACESSÓRIOS REQUERIDOS**

E		04
H		16
M		02

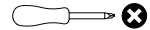
**FERRAMENTAS NECESSÁRIAS**

Para porta (8): Defina para o modo de perfuração.

Faça a furação passante para fixar o puxador (M).

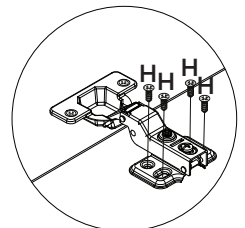
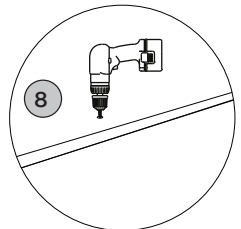
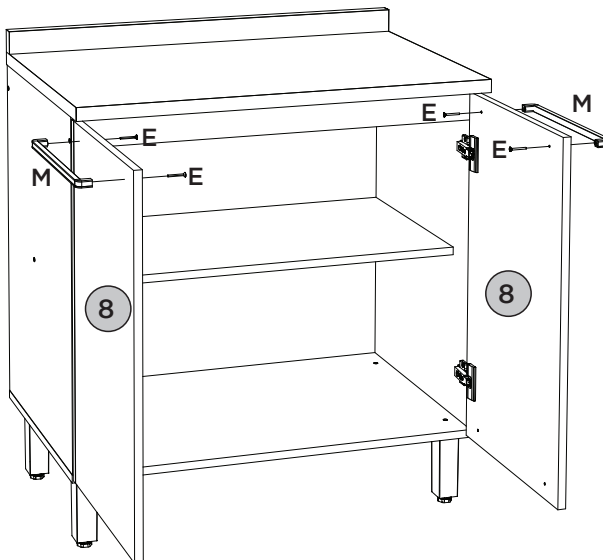

## ACESSÓRIOS REQUERIDOS

A		01	R		01
H		02	S		14
P		01	T		04
Q		01	U		03

## FERRAMENTAS NECESSÁRIAS



OU



Para parede: Ajustar no modo perfuração

**Pesos máximos recomendados com carga distribuída**  
**Peso máximo recomendado con la carga distribuida**  
**Recommended maximum weight with distributed load.**

PERFECT CORRECTION  
 CORRECCIÓN PERFECTA

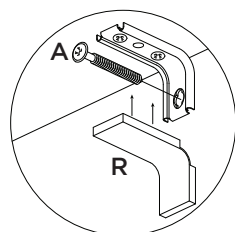
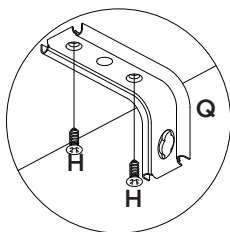
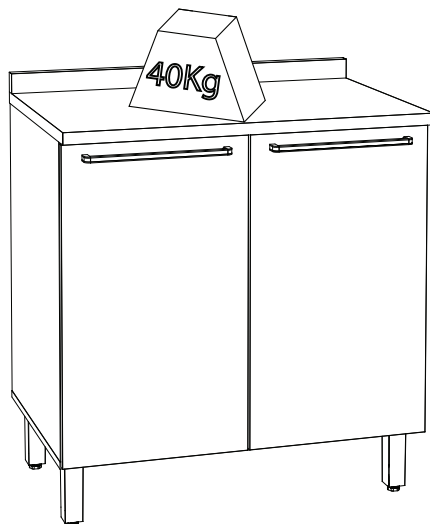
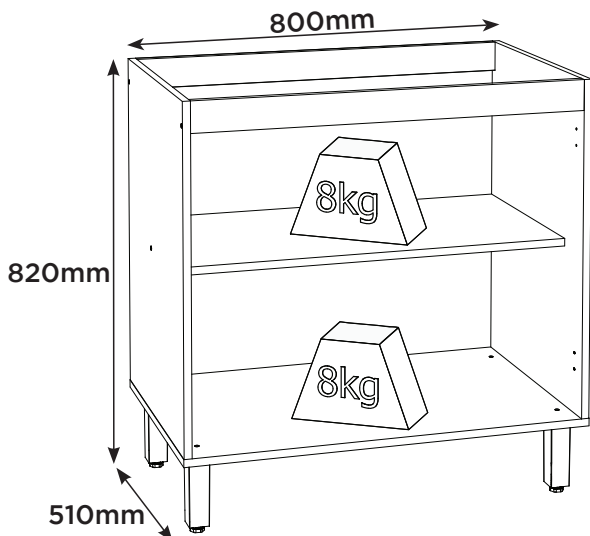
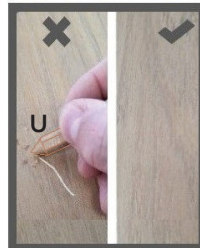

### RECOMENDAÇÃO

Para fixar o móvel na parede usar o suporte de fixação (Q), o parafuso 4,0x14mm CHT (H), a Bucha 8mm (P) e o parafuso 5,0x50mm FLA (A).

### RECOMENDACIÓN

Para conectar el móvil a la pared con el soporte (Q), tornillo 4,0x14mm CHT (H), el casquillo de 8 mm (P) y el 5,0 x50mm tornillo FLA (A).

### RECOMMENDATION

To fix the furniture to the wall use the fixing bracket (Q), the 4,0x14mm CHT (H) screw, the 8mm bushing (P) and the 5.0x50mm FLA screw (A).

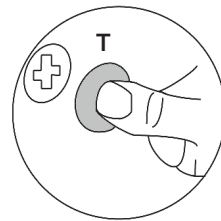
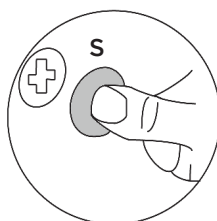

**Produto Concluído**  
**Producto terminado**  
**Finished Product**

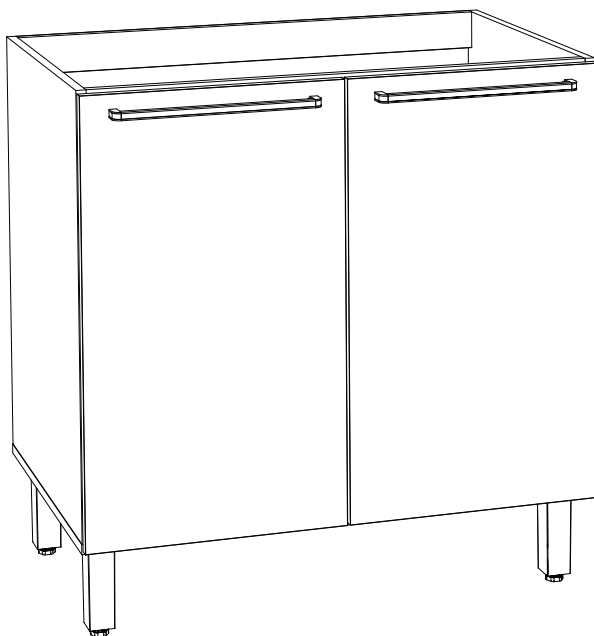

**HENN**Ind. e Com. de Móveis Henn  
Mondai - SC - Brasil

☎ +55 49 3674.3500

📧 @moveishenn  
www.henn.com.br**INSTRUÇÕES DE  
MONTAGEM**INSTRUCCIONES DE MONTAJE  
ASSEMBLY INSTRUCTIONS**Balcão Pia 02 Gavetas 03 Portas Requinte |**  
Pia Contador 02 Cajones 03 Puertas Requinte |  
Balcony Pia 02 Drawers 03 Doors Requinte

C640-217 Nature/Areia

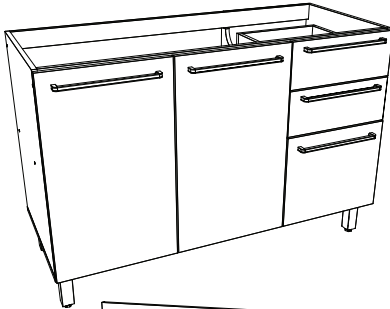
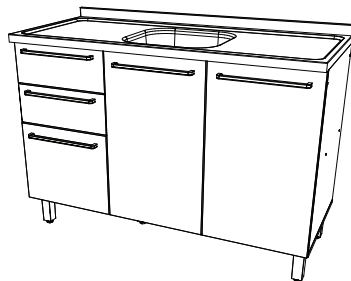
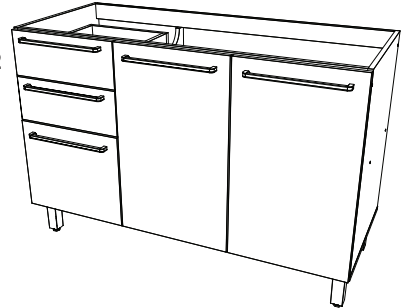
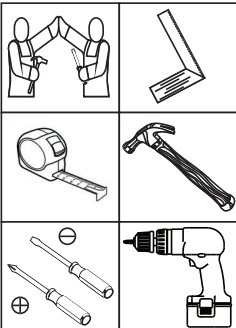
Opção 01  
Opción 01  
Option 01Opção 02  
Opción 02  
Option 02Requisitos para montagem  
Requisitos para la montaje  
Assembly RequirementsImagens meramente ilustrativas,  
não acompanha o produto.  
Imágenes ilustrativas, no incluidas  
con el producto.  
Illustrative images, not included  
with the product.**AVISO**

Para limpeza de seu móvel, use uma franela seca ou umedecida, e não utilize produtos químicos que possam danificar seu produto.

**SISTEMA DE MONTAGEM**

O sistema de montagem dos produtos, funciona de acordo com a ordem crescente dos números indicados no desenho. Ex: 01, 02, 03, 04... até a conclusão da montagem.

**ASSISTÊNCIA TÉCNICA**

Para solicitação de Assistência Técnica você consumidor deverá entrar em contato com o Lojista a qual você realizou a compra deste produto e solicitar a assistência técnica das peças avariadas. A garantia abrange todas as peças, partes e componentes que eventualmente venham apresentar defeito de fabricação no prazo de 03 (três) meses, contando a partir da entrega do produto ao consumidor, mediante nota fiscal de compra. Se houver qualquer alteração na estrutura do produto ou ocorrer defeito por negligência do montador/consumidor em relação a instrução de montagem e manuseio, não será fornecido assistência técnica gratuita.

**ADVERTENCIA**

Para limpieza de su móvil, use una franela seca o húmeda, y no utilice productos químicos que puedan dañar su producto.

**SISTEMA DE MONTAJE**

El sistema de montaje de los productos funciona de acuerdo con el orden creciente de los números indicados en el dibujo. Ej.: 01, 02, 03, 04... hasta la conclusión del montaje.

**ASISTENCIA TÉCNICA**

Para solicitar Asistencia Técnica, el consumidor debe comunicarse con el Comercio que usted realizó la compra de este producto y solicita asistencia técnica para las partes dañadas. La garantía cubre todas las partes, piezas y componentes que eventualmente puedan presentar defecto de fabricación en el plazo de 03 (tres) meses, contados a partir de la entrega del producto al consumidor, mediante factura de compra. Si se produce algún cambio en la estructura del producto o se produce un defecto por negligencia del montador/consumidor en relación con las instrucciones de montaje y manipulación, no se prestará asistencia técnica gratuita.

**NOTICE**

To clean your furniture, use a dry or wet cloth, and do not use chemicals that may damage your product.

**ASSEMBLY SYSTEM**

The products' assembly system works according to the increasing order of the indicated numbers. For example: 01, 02, 03, 04 ... to the end of the assembly.

**TECHNICAL ASSISTANCE**

To request Technical Assistance, the consumer must contact the retailer from whom you purchased this product and request technical assistance for the damaged parts. The warranty covers all parts, parts and components that may eventually present a manufacturing defect within a period of 03 (three) months, counting from the delivery of the product to the consumer, by means of a purchase invoice. If there is any change in the structure of the product or defect occurs due to negligence of the assembler/consumer in relation to the assembly and handling instruction, free technical assistance will not be provided.

## ACESSÓRIOS | ACCESORIOS | ACCESSORIES

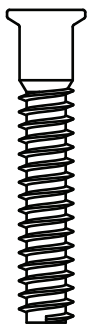

**x5**

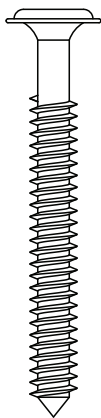

**x2**



**x4**



**x2**



**x14**

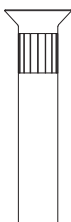

**x6**

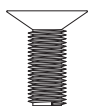

**x6**

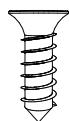

**x98**



**x4**



**x10**

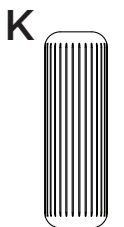

**x32**



**x38**



**x13**



Os parafusos (F/G) devem ser usados somente quando este módulo for acoplado a outro módulo componível Henn.



Los tornillos (F/G) se debe utilizar sólo cuando el módulo está conectado a otro módulo componible Henn.



Screws (F/G) are to be used only when this module is mated to another Henn buildable module.

Parafusos em escala  
Tornillos escalados  
Scaled screws **1:1**

## ACESSÓRIOS | ACCESORIOS | ACCESSORIES

N

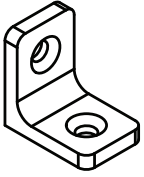

x11

O

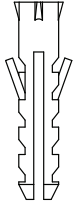

x2

P

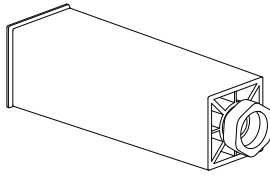

x5

Q

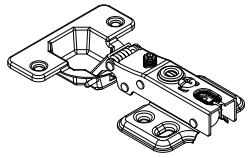

x6

R

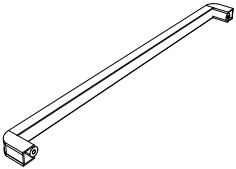

x5

S

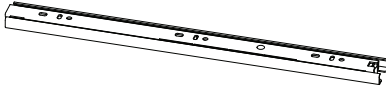

x2

T

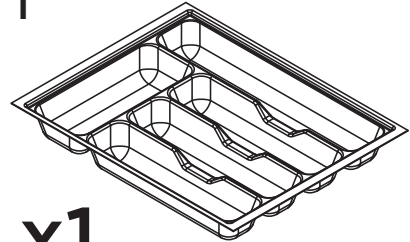

x1

U

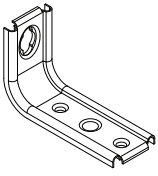

x2

V

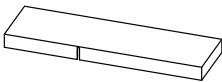

x2

W

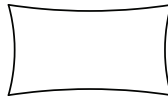

x2

X

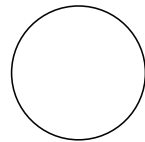

x6

Y



x26

Z

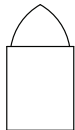

x3

AA



x1

# LISTA DE PEÇAS | LISTA DE PIEZAS | LIST OF PIECES

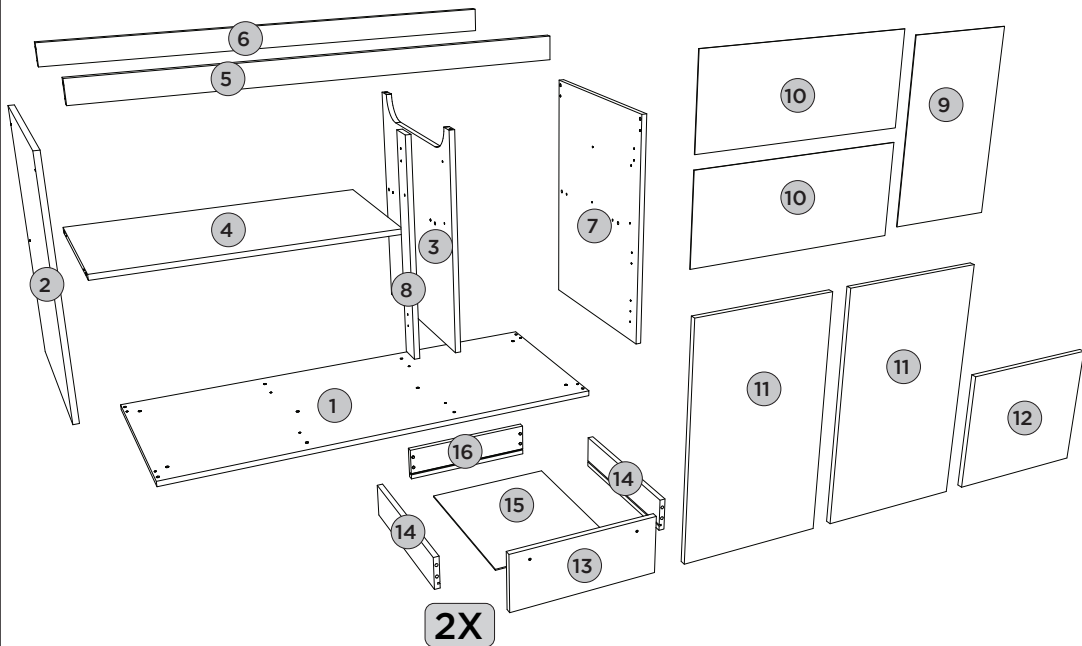

Item	Caixa Caja Box	Qty Ctd Qty	Descrição Descripción Description	Dimensões (mm)   Dimensiones (mm)		
				Comprimento Largo Length	Largura Ancho Width	Espessura Grosor Thickness
1	1/1	01	BASE   BASE   BASE	1200	490	15
2	1/1	01	LATERAL ESQUERDA   LATERAL IZQUIERDA   LEFT SIDE	660	490	15
3	1/1	01	DIVISÃO   DIVISIÓN   DIVISION	600	490	15
4	1/1	01	PRATELEIRA   ESTANTE   SHELF	783	400	15
5	1/1	01	TRAVESSA FRONTAL   TRAVESAÑO FRONTAL   FRONT CROSSBAR	1168	60	15
6	1/1	01	TRAVESSA TRASEIRA   TRAVESAÑO TRASERO   REAR BUMPER	1168	60	15
7	1/1	01	LATERAL DIREITA   LATERAL DERECHA   RIGHT SIDE	660	490	15
8	1/1	01	PILASTRA DA PORTA   PILASTRA PUERTA   PILASTER DOOR	597	60	15
9	1/1	01	FUNDO MENOR   FONDO MENOR   MINOR FUND	672	389	3
10	1/1	02	FUNDO   FONDO   BOTTOM	802	335	3
11	1/1	02	PORTA   PUERTA   DOOR	665	396	15
12	1/1	01	PORTA MENOR   PUERTA MENOR   SMALLER DOOR	396	337	15
13	1/1	02	FRENTE DE GAVETA   FRENTE DE CAJÓN   FRONT OF DRAWER	396	160	15
14	1/1	04	LADO DE GAVETA MENOR   LADO DEL CAJÓN MENOR   SMALLEST DRAWER SIDE	400	90	15
15	1/1	02	FUNDO DE GAVETA   FONDO DE CAJÓN   BOTTOM OF DRAWER	411	326	3
16	1/1	02	RIPA DE TRÁS   MALLA DETRÁS   REAR LATH	345	90	15







# PASSO 1

ITM/C640-

## PEÇAS REQUERIDAS

1	BASE	x1
4	PRATELEIRA	x1
5	TRAVESSA FRONTAL	x1
6	TRAVESSA TRASEIRA	x1

## ACESSÓRIOS REQUERIDOS

A		05
K		08
P		05
W		

## FERRAMENTAS NECESSÁRIAS

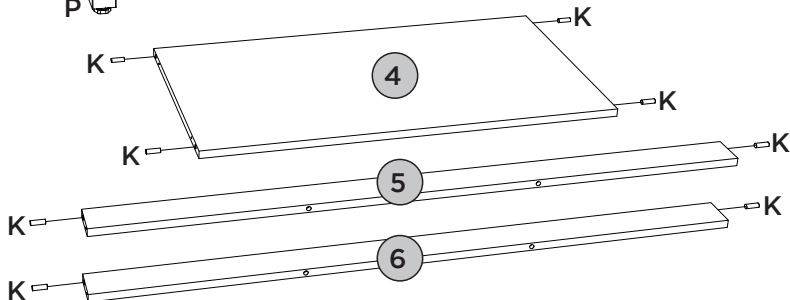
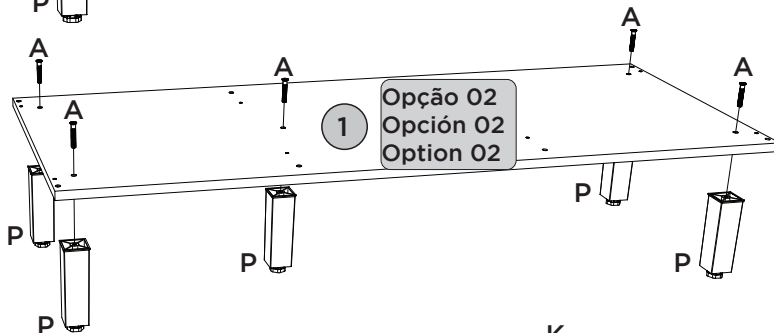
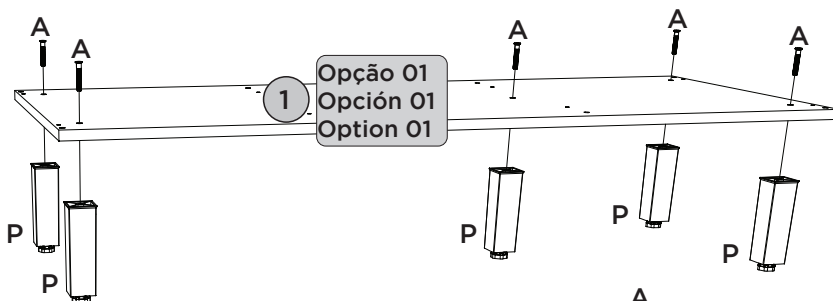
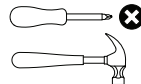

Utilizar o sachê de cola (W) em todas as cavilhas (K) do produto.

Con el pegamento sobre (W) en todos los pernos (K) producto.

Use the glue sachet (W) on all the pegs (K) of the product.





# PASSO 2

ITM/C640-

## PEÇAS REQUERIDAS

2	LATERAL ESQUERDA	x1
3	DIVISÃO	x1
7	LATERAL DIREITA	x1

## ACESSÓRIOS REQUERIDOS

H		12
K		08
S		04
W		

## FERRAMENTAS NECESSÁRIAS

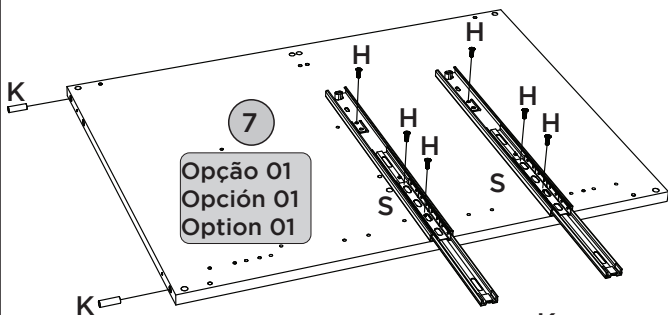
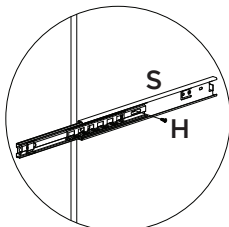
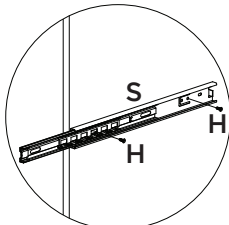
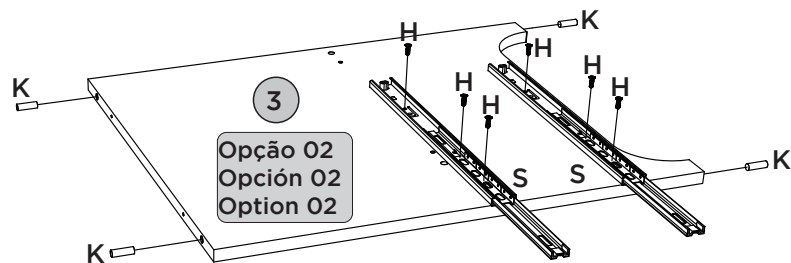
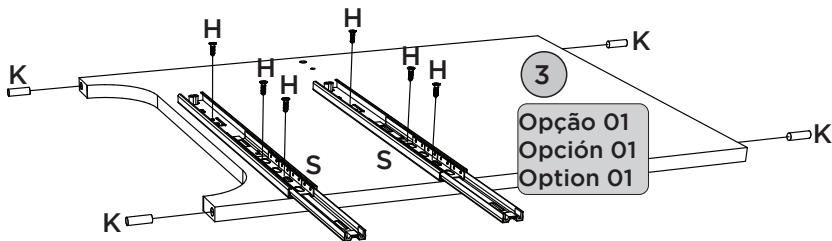
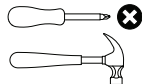

Na Opção 01 a Lateral Esquerda (02) ficará apenas com cavilhas (K), assim como na opção 02 a Lateral Direita (07) ficará apenas com cavilhas (K).

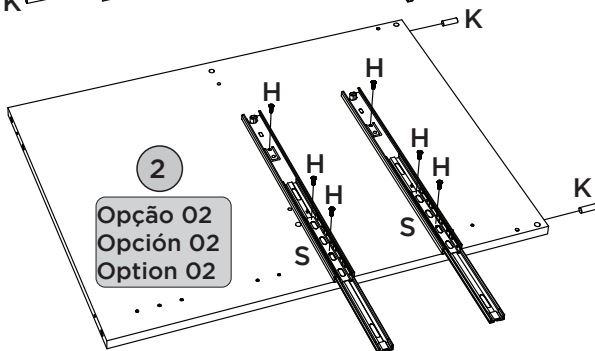

En la Opción 01 el Lado Izquierdo (02) solo tendrá pasadores (K), al igual que en la opción 02 el Lado Derecho (07) solo tendrá pasadores (K).

In Option 01 the Left Side (02) will only have pins (K), just as in option 02 the Right Side (07) will only have pins (K).



# PASSO 3

ITM/C640-

## PEÇAS REQUERIDAS

1	BASE	x1
2	LATERAL ESQUERDA	x1
3	DIVISÃO	x1
4	PRATELEIRA	x1
5	TRAVESSA FRONTAL	x1
6	TRAVESSA TRASEIRA	x1
7	LATERAL DIREITA	x1

## ACESSÓRIOS REQUERIDOS

E		10
W		

## FERRAMENTAS NECESSÁRIAS

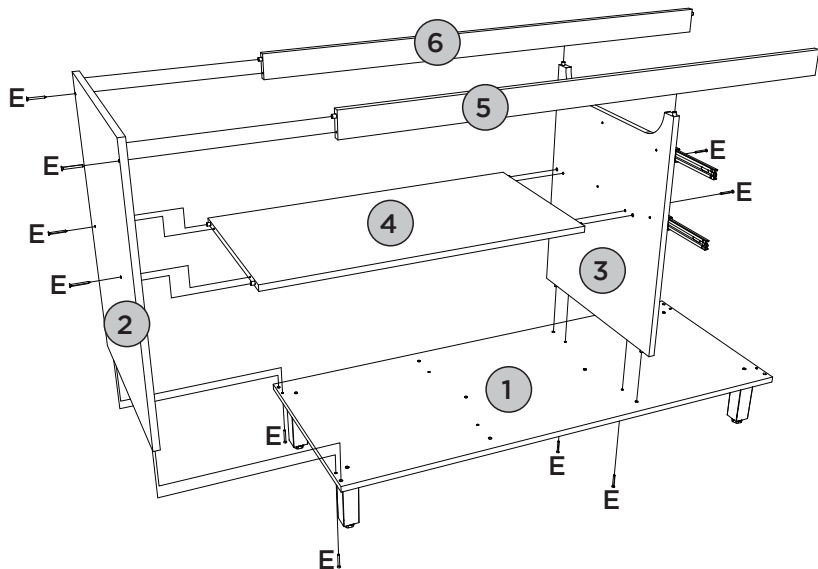
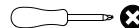

Opção 01  
Opción 01  
Option 01



Opção 02  
Opción 02  
Option 02

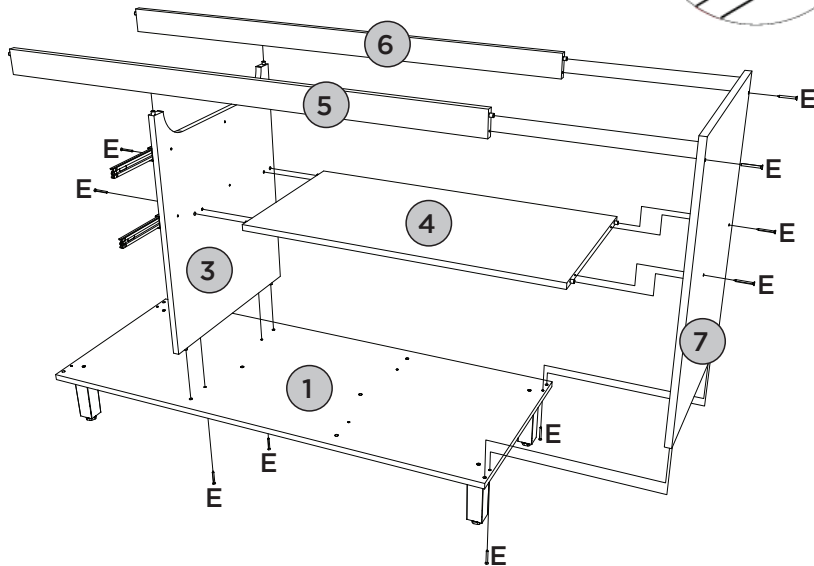





# PASSO 4

ITM/C640-

## PEÇAS REQUERIDAS

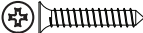
2	LATERAL ESQUERDA	x1
7	LATERAL DIREITA	x1
8	PILASTRA DA PORTA	x1

## ACESSÓRIOS REQUERIDOS

D		02
E		04
H		02
N		01
W		

## FERRAMENTAS NECESSÁRIAS



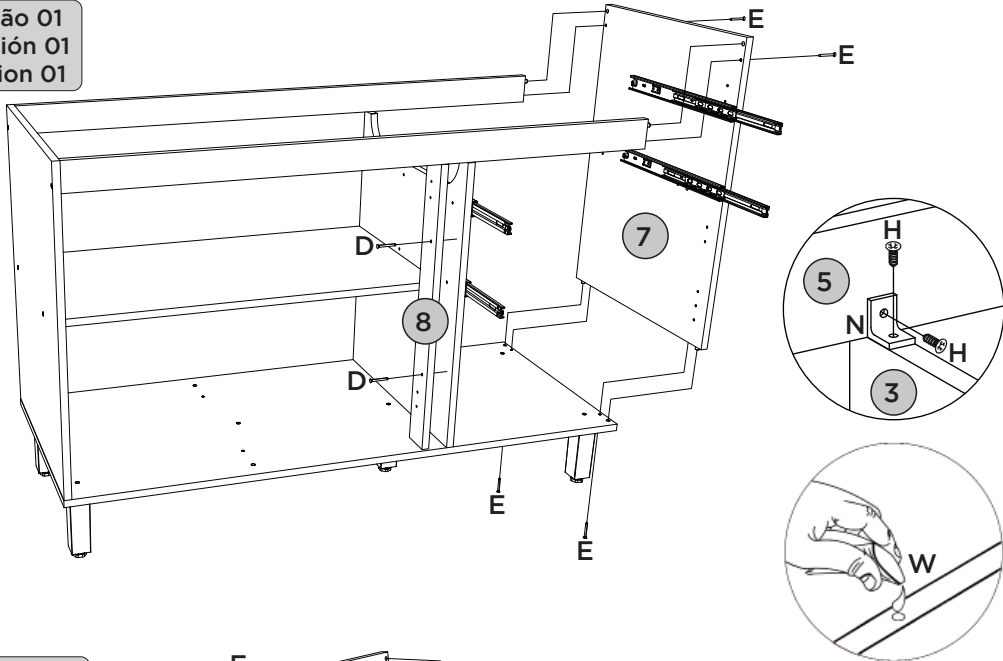

Opção 01  
Opción 01  
Option 01

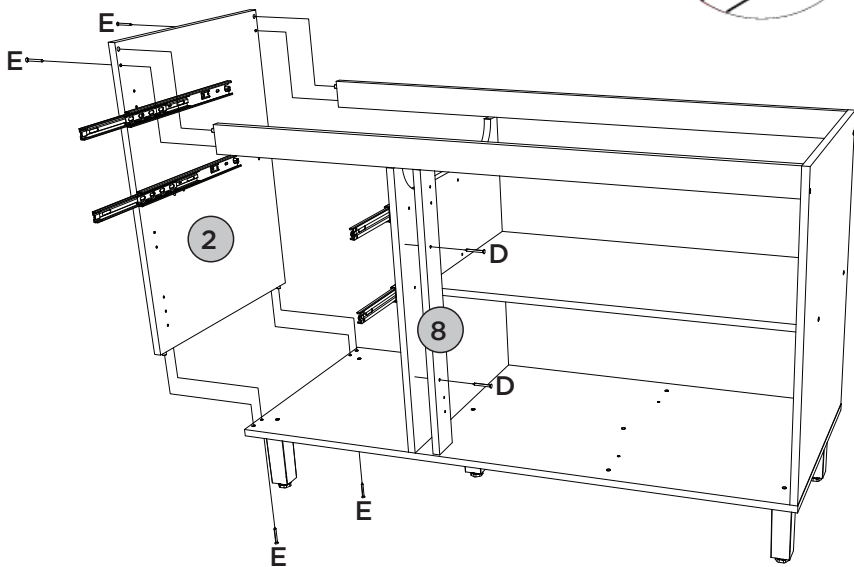

Opção 02  
Opción 02  
Option 02



## ACESSÓRIOS REQUERIDOS

C		04
H		12
N		06

## FERRAMENTAS NECESSÁRIAS



Esse tampo é opcional e é vendido separadamente (C905-128).

Esta vez es opcional y se vende por separado (C905-128).

This top is optional and is sold separately (C905-128).

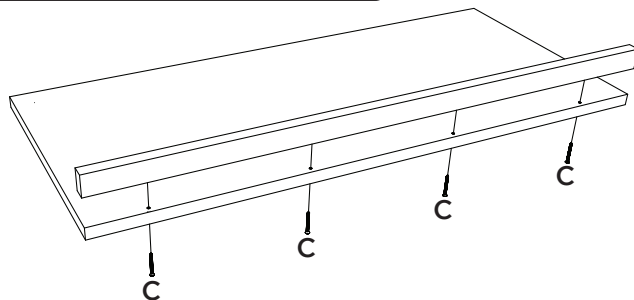

Opção 01  
Opción 01  
Option 01

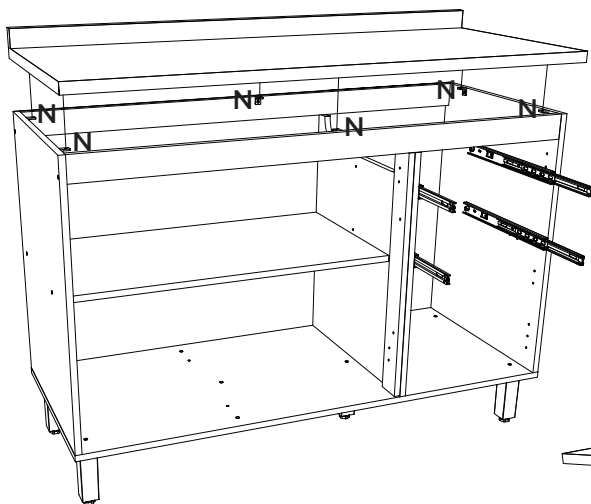

Opção 02  
Opción 02  
Option 02

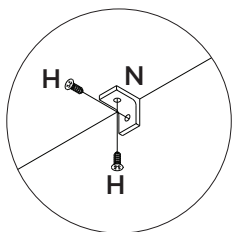
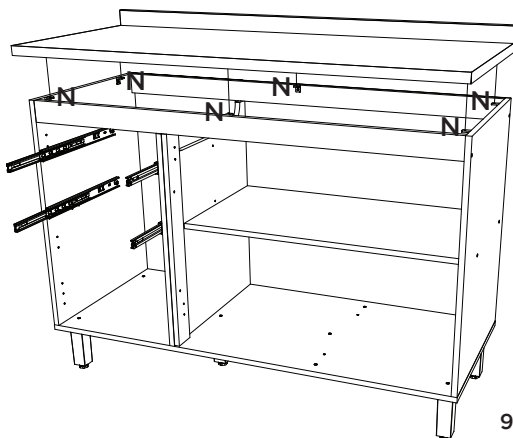



# PASSO 6

ITM/C640-

## PEÇAS REQUERIDAS

9	FUNDO MENOR	x1
10	FUNDO	x2

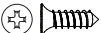
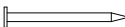
## ACESSÓRIOS REQUERIDOS

H		12
L		38
M		13

## FERRAMENTAS NECESSÁRIAS

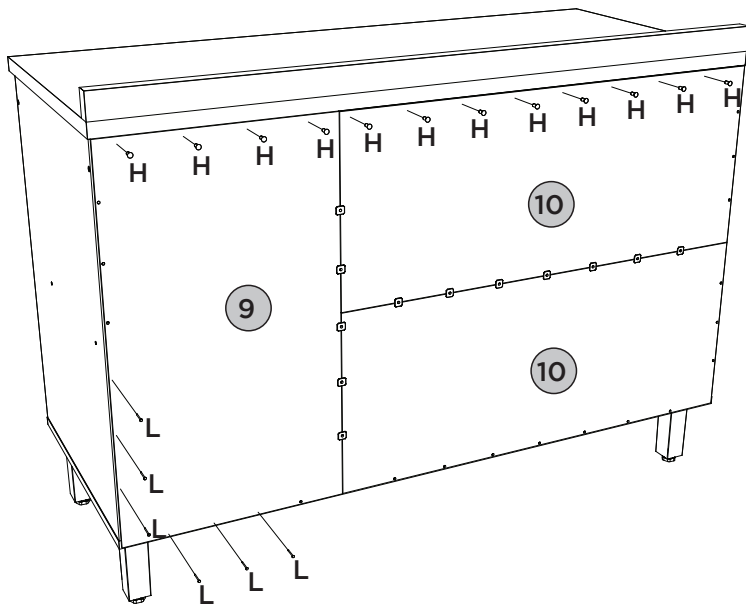
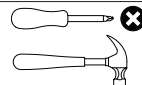

Opção 01  
Opción 01  
Option 01

Opção 02  
Opción 02  
Option 02

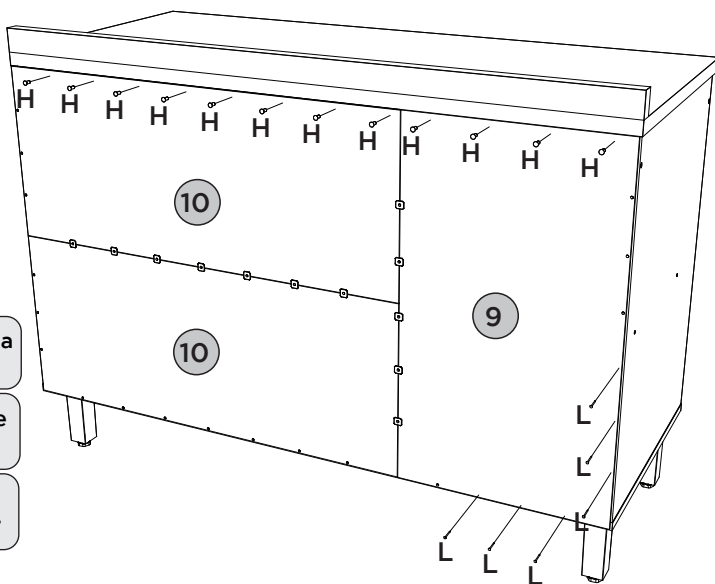

Fixar os pregos a uma distância de 100mm de um para outro.



Fijar las uñas a un distancia de 100mm uno a otro.

Fix the nails at a distance of 100mm from one to the other

## PEÇAS REQUERIDAS

11	PORTA	x2
12	PORTA MENOR	x1

## ACESSÓRIOS REQUERIDOS

H		12
Q		06

## FERRAMENTAS NECESSÁRIAS

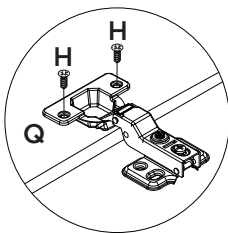
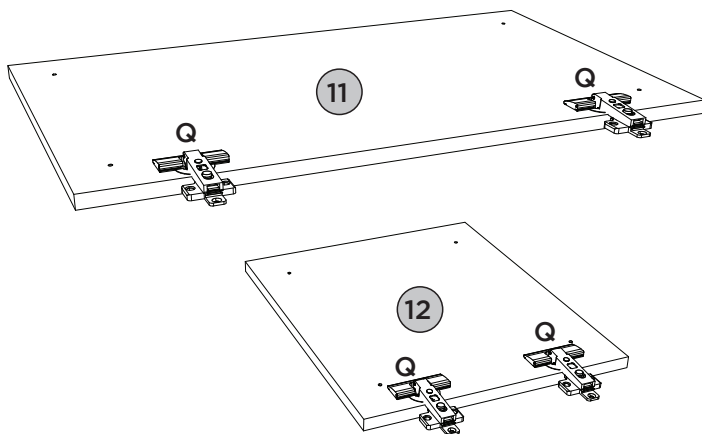
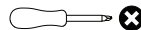



# PASSO 8

ITM/C640-

## PEÇAS REQUERIDAS

11	PORTA	x2
12	PORTA MENOR	x1

## ACESSÓRIOS REQUERIDOS

H		24
J		06
R		03

## FERRAMENTAS NECESSÁRIAS



Para porta (11 e 12): Defina para o modo de perfuração.  
Faça a furação passante para fixar os puxadores (R).

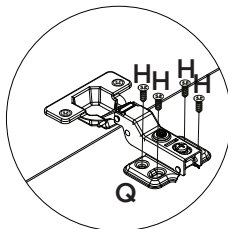
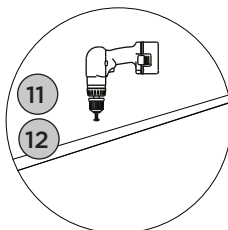
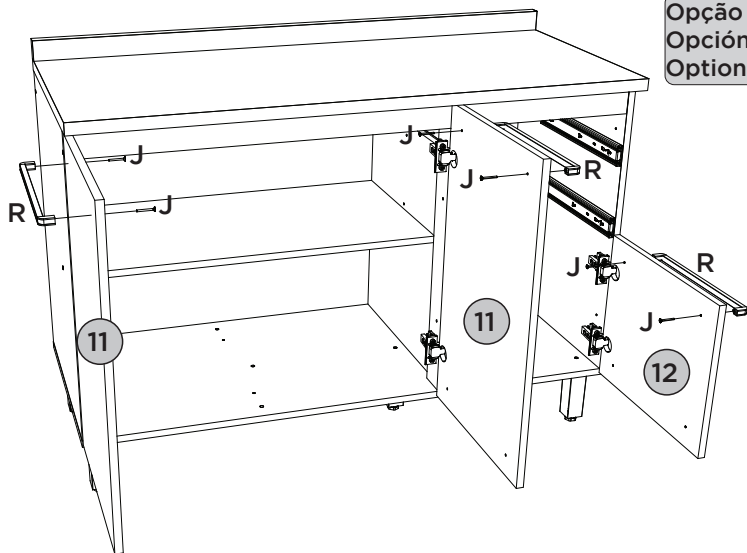

Opção 02  
Opción 02  
Option 02

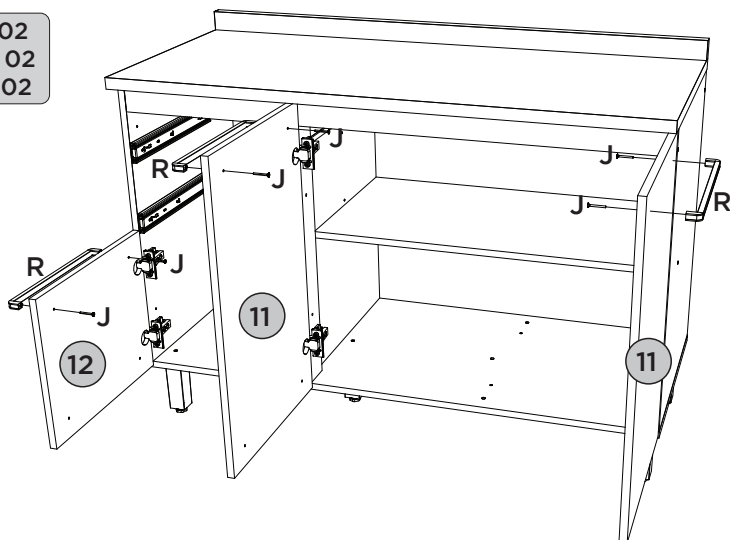







# PASSO 9

ITM/C640-

## PEÇAS REQUERIDAS

13	FRENTE DE GAVETA	x2
14	LADO DE GAVETA	x4
15	FUNDO DE GAVETA	x2

## ACESSÓRIOS REQUERIDOS

H		08
K		16
N		04
W		

## FERRAMENTAS NECESSÁRIAS

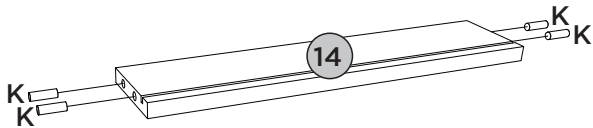
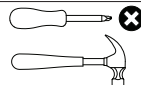

**1º**  
**2X**

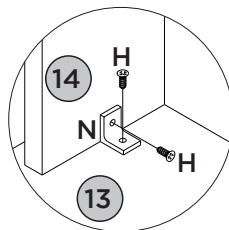
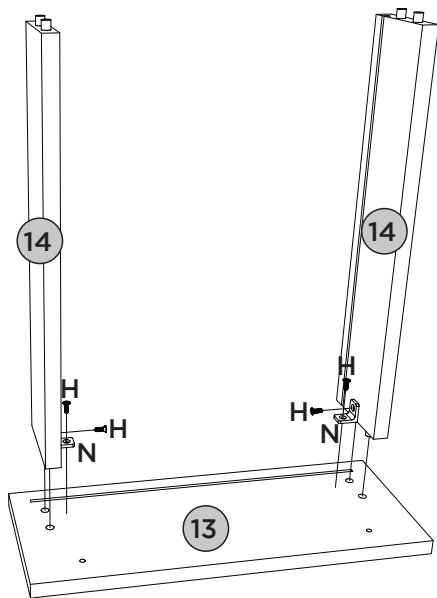

**2º**  
**2X**

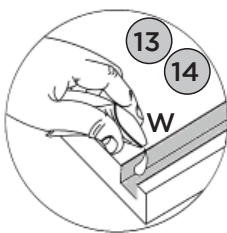
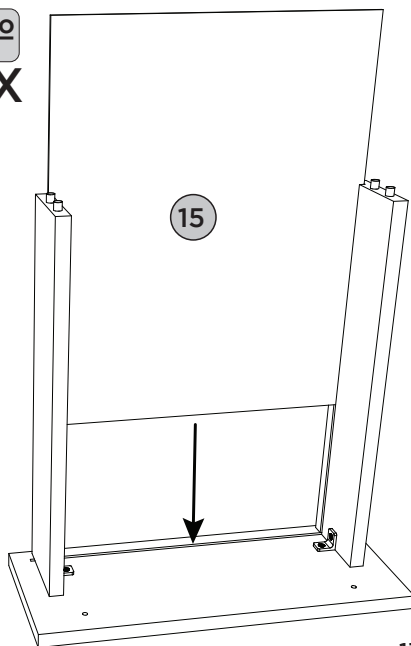

# PASSO 10

ITM/C640-

## PEÇAS REQUERIDAS

16	RIPA DE TRÁS	x2
----	--------------	----

## ACESSÓRIOS REQUERIDOS

H		12
I		04
J		04
R		02
S		04
W		

## FERRAMENTAS NECESSÁRIAS

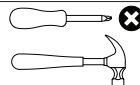

3º  
2X

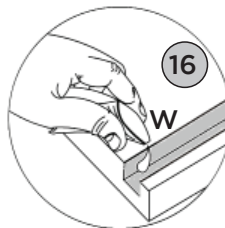
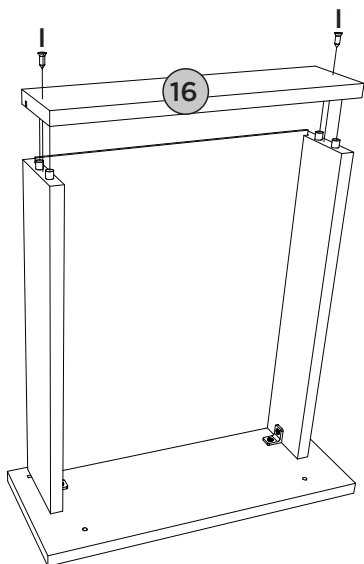

4º  
2X

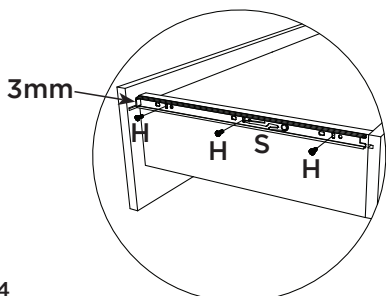
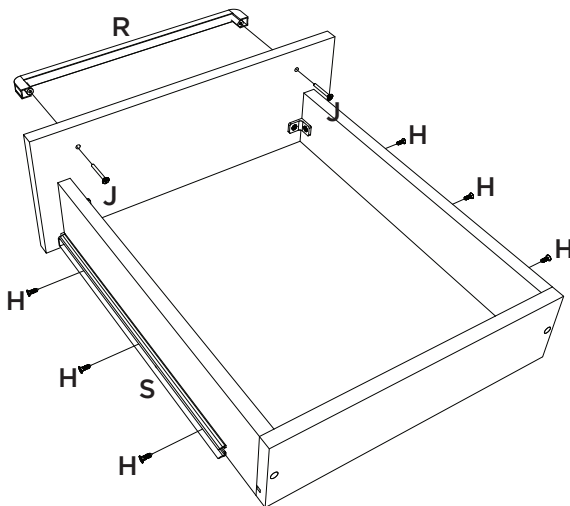

## ACESSÓRIOS REQUERIDOS

B		02	X		06
H		04	Y		26
O		02	Z		03
U		02	AA		01
V		02			

## FERRAMENTAS NECESSÁRIAS



OU

Para parede: Ajustar no modo perfuração.  
Para peça (02 e 07): Usar torque 5.

Pesos máximos recomendados com carga distribuída  
Peso máximo recomendado con la carga distribuida  
Recommended maximum weight with distributed load.

PERFECT CORRECTION  
CORRECCIÓN PERFECTA

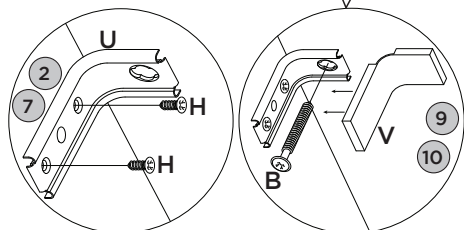
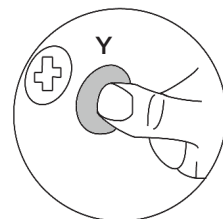
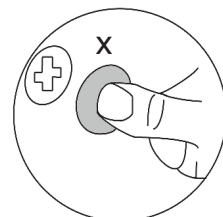
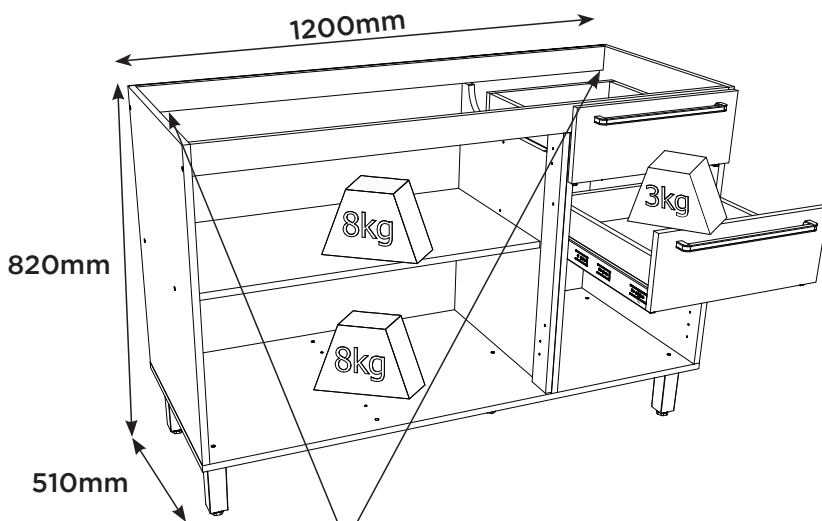
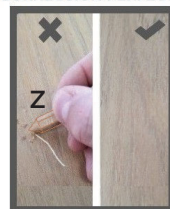

### RECOMENDAÇÃO

Para fixar o móvel na parede usar o suporte de fixação (U), o parafuso 4,0x14mm CHT (H), a Bucha 8mm (O) e o parafuso 5,0x50mm FLA (B).

### RECOMENDACIÓN

Para conectar el móvil a la pared con el soporte (U), tornillo 4,0 x14mm CHT (H), el casquillo de 8 mm (O) y el 5,0 x50mm tornillo FLA (B).

### RECOMMENDATION

To fix the furniture to the wall use the fixing bracket (U), the 4,0x14mm CHT (H) screw, the 8mm bushing (O) and the 5.0x50mm FLA screw (B).

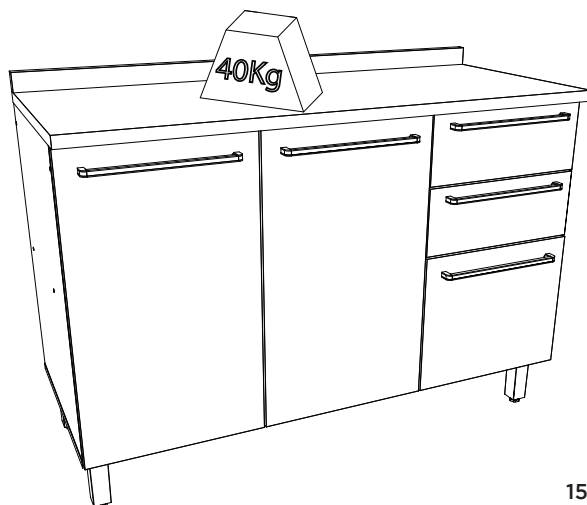

**Producto Concluído**  
**Producto terminado**  
**Finished Product**

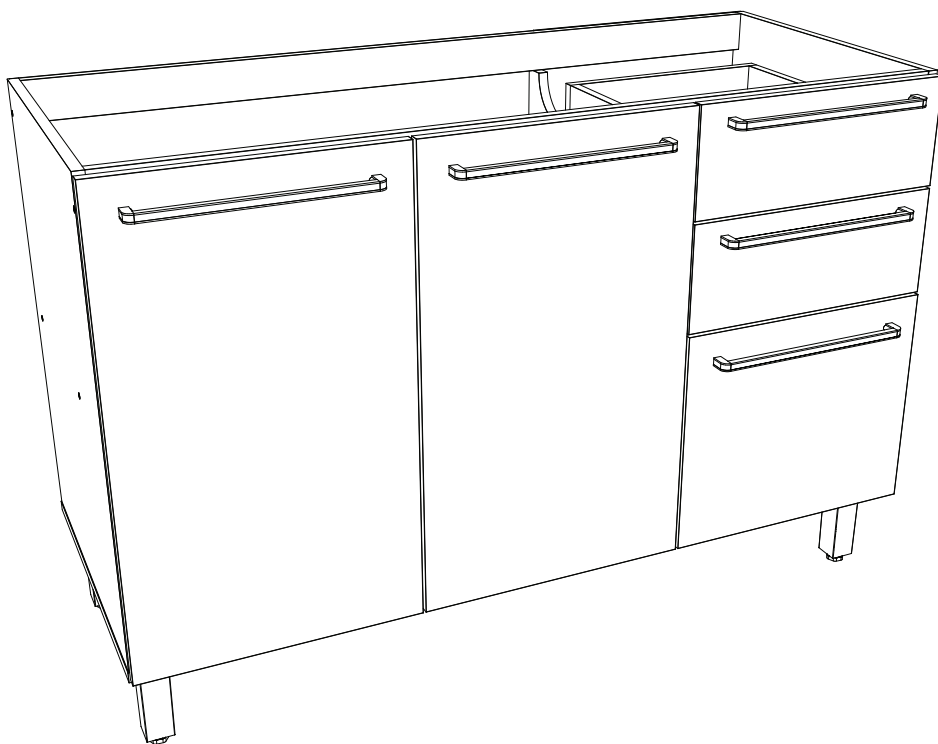

**HENN**Ind. e Com. de Móveis Henn  
Mondaí - SC - Brasil

☎ +55 49 3674.3500

📱 @moveishenn  
www.henn.com.br**INSTRUÇÕES DE  
MONTAGEM**INSTRUCCIONES DE MONTAJE  
ASSEMBLY INSTRUCTIONS**Balcão Canto Reto 01 Porta Requinte | Balcón de  
Esquina Reto 01 Puerta Requinte | Balcony Corner Straight 01  
Door Requinte**

C641-217 Nature/Areia HP

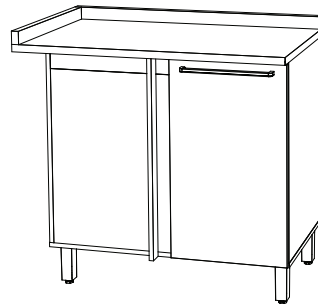
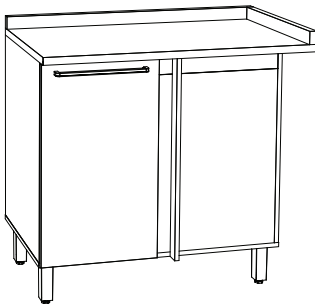
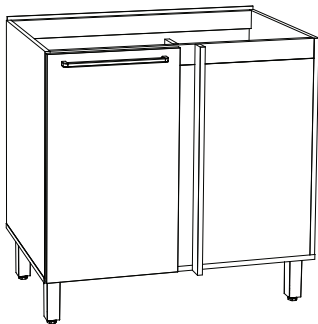
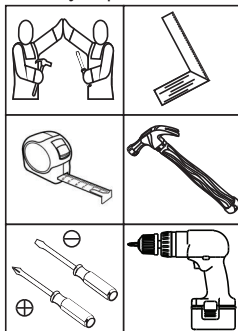
**Opção 01  
Opción 01  
Option 01****Opção 02  
Opción 02  
Option 02****Requisitos para montagem  
Requisitos para la montaje  
Assembly Requirements**

Imagens meramente ilustrativas,  
não acompanha o produto.  
Imágenes ilustrativas, no incluidas  
con el producto.  
Illustrative images, not included  
with the product.

**AVISO**

Para limpeza de seu móvel, use uma franela seca ou umedecida, e não utilize produtos químicos que possam danificar seu produto.

**SISTEMA DE MONTAGEM**

O sistema de montagem dos produtos, funciona de acordo com a ordem crescente dos números indicados no desenho. Ex: 01, 02, 03, 04... até a conclusão da montagem.

**ASSISTÊNCIA TÉCNICA**

Para solicitação de Assistência Técnica você consumidor deverá entrar em contato com o Lojista o qual você realizou a compra deste produto e solicitar a assistência técnica das peças avariadas. A garantia abrange todas as peças, partes e componentes que eventualmente venham apresentar defeito de fabricação no prazo de 03 (três) meses, contando a partir da entrega do produto ao consumidor, mediante nota fiscal de compra. Se houver qualquer alteração na estrutura do produto ou ocorrer defeito por negligência do montador/consumidor em relação a instrução de montagem e manuseio, não será fornecido assistência técnica gratuita.

**ADVERTENCIA**

Para limpieza de su móvil, use una franela seca o húmeda, y no utilice productos químicos que puedan dañar su producto.

**SISTEMA DE MONTAJE**

El sistema de montaje de los productos funciona de acuerdo con el orden creciente de los números indicados en el dibujo. Ej.: 01, 02, 03, 04... hasta la conclusión del montaje.

**ASISTENCIA TÉCNICA**

Para solicitar Asistencia Técnica, el consumidor debe comunicarse con el Comercio que usted realizó la compra de este producto y solicita asistencia técnica para las partes dañadas. La garantía cubre todas las partes, piezas y componentes que eventualmente puedan presentar defecto de fabricación en el plazo de 03 (tres) meses, contados a partir de la entrega del producto al consumidor, mediante factura de compra. Si se produce algún cambio en la estructura del producto o se produce un defecto por negligencia del montador/consumidor en relación con las instrucciones de montaje y manipulación, no se prestará asistencia técnica gratuita.

**NOTICE**

To clean your furniture, use a dry or wet cloth, and do not use chemicals that may damage your product.

**ASSEMBLY SYSTEM**

The products' assembly system works according to the increasing order of the indicated numbers. For example: 01, 02, 03, 04 ... to the end of the assembly.

**TECHNICAL ASSISTANCE**

To request Technical Assistance, the consumer must contact the retailer from whom you purchased this product and request technical assistance for the damaged parts. The warranty covers all parts, parts and components that may eventually present a manufacturing defect within a period of 03 (three) months, counting from the delivery of the product to the consumer, by means of a purchase invoice. If there is any change in the structure of the product or defect occurs due to negligence of the assembler/consumer in relation to the assembly and handling instruction, free technical assistance will not be provided.

## ACESSÓRIOS | ACCESORIOS | ACCESSORIES

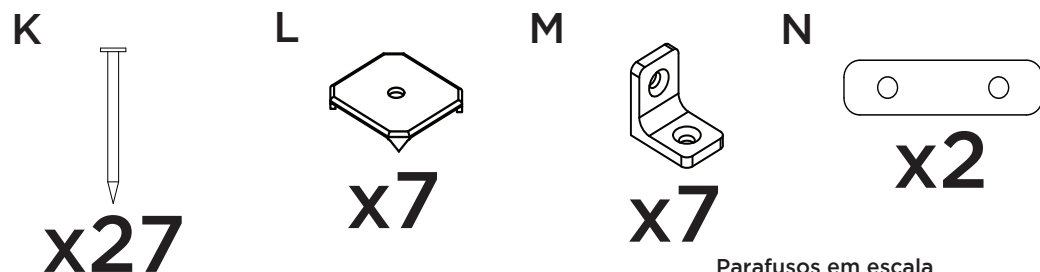
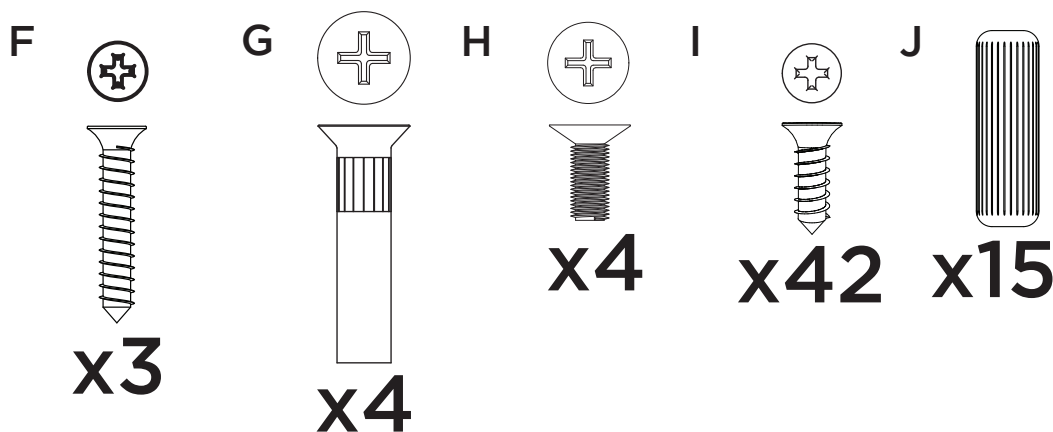
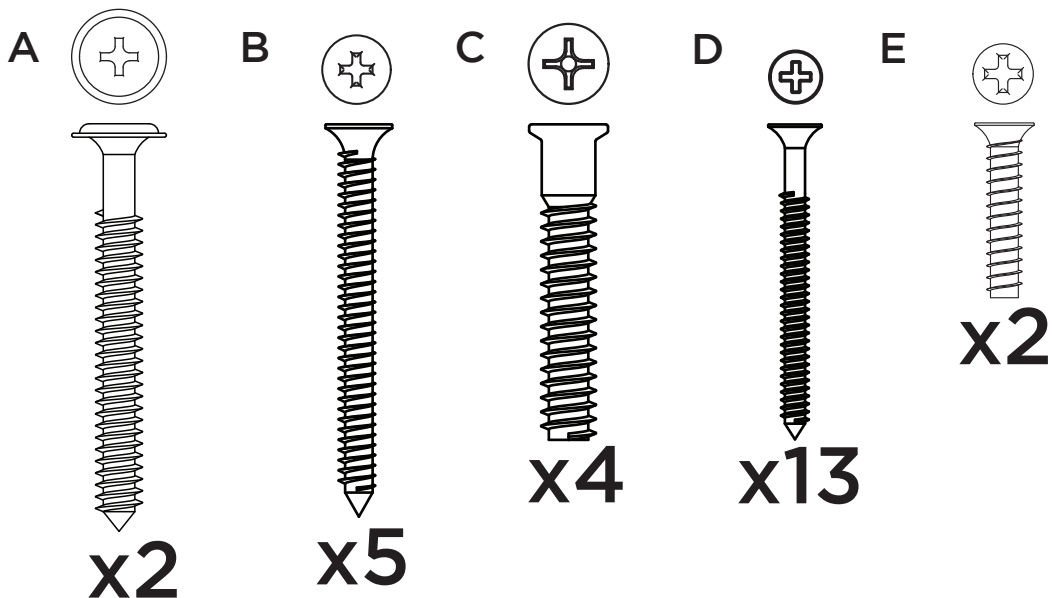

Parafusos em escala  
Tornillos escalados  
Scaled screws **1:1**

## ACESSÓRIOS | ACCESORIOS | ACCESSORIES

O

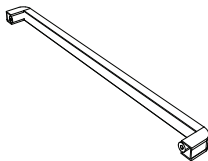

x1

P

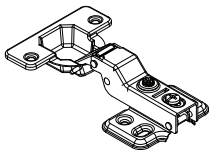

x2

Q

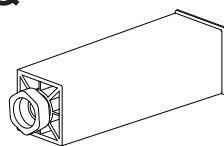

x4

R

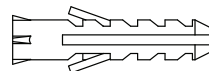

x2

S

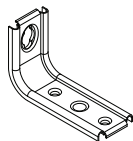

x2

T

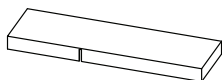

x2

U

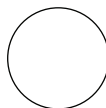

x12

V

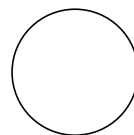

x4

W

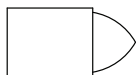

x3

X

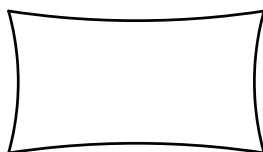

x2

Y



x1



Os parafusos (G/H) devem ser usados somente quando este módulo for acoplado a outro módulo componível Henn.



Los tornillos (G/H) se debe utilizar sólo cuando el módulo está conectado a otro módulo componible Henn.



Screws (G/H) are to be used only when this module is mated to another Henn buildable module.

## LISTA DE PEÇAS | LISTA DE PIEZAS | LIST OF PIECES

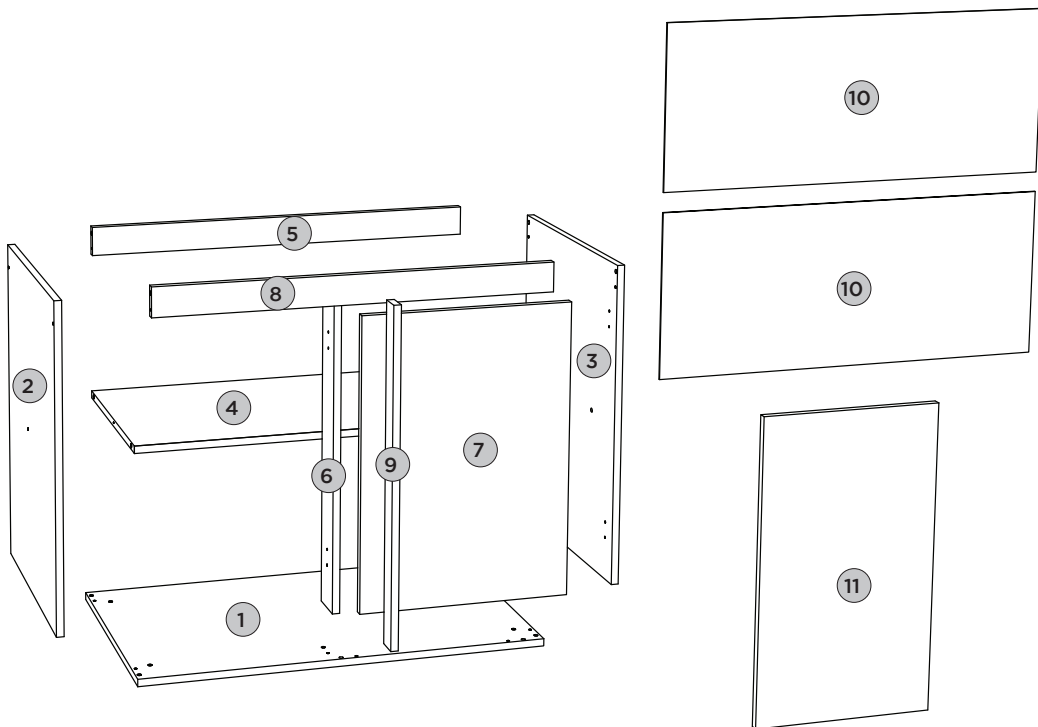

Item	Caixa Caja Box	Qty Ctd Qty	Descrição Descripción Description	Dimensões (mm)   Dimensiones (mm)   Dimensions (mm)		
				Comprimento Largo Length	Largura Ancho Width	Espessura Grosor Thickness
1	1/1	01	BASE   BASE   BASE	840	490	15
2	1/1	01	LATERAL ESQUERDA   LATERAL IZQUIERDA   LEFT SIDE	660	490	15
3	1/1	01	LATERAL DIREITA   LATERAL DERECHA   RIGHT SIDE	660	490	15
4	1/1	01	PRATEIRA   ESTANTE   SHELF	808	400	15
5	1/1	01	TRAVESSA TRASEIRA   TRAVESAÑO TRASERO   REAR BUMPER	808	60	15
6	1/1	01	PILASTRA DA PORTA   PUERTA PILASTRA   DOOR PILASTER	660	75	15
7	1/1	01	FRENTE FIXA   FRENTE FIJA   FIXED FRONT	600	435	15
8	1/1	01	TRAVESSA FRONTAL   TRAVESAÑO FRONTAL   FRONT CROSSBAR	808	60	15
9	1/1	01	TRAVESSA ESTRUTURAL   TRAVESAÑO ESTRUCTURAL   STRUCTURAL CROSSBEAM	675	43	15
10	1/1	02	FUNDO   FONDO   BOTTOM	832	341	3
11	1/1	01	PORTA   PUERTA   DOOR	665	396	15



# PASSO 1

ITM/C641-

## PEÇAS REQUERIDAS

1	BASE	x1
2	LATERAL ESQUERDA	x1
3	LATERAL DIREITA	x1
4	PRATELEIRA	x1
5	TRAVESSA TRASEIRA	x1
6	PILASTRA DA PORTA	x1
7	FRENTE FIXA	x1
8	FRONTAL FRONTAL	x1

## ACESSÓRIOS REQUERIDOS

C		04
J		15
Q		04
X		

## FERRAMENTAS NECESSÁRIAS

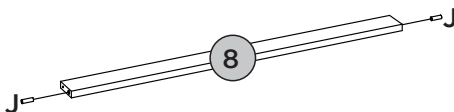
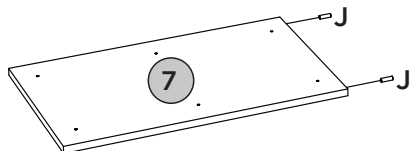
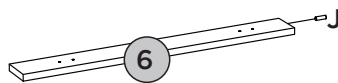
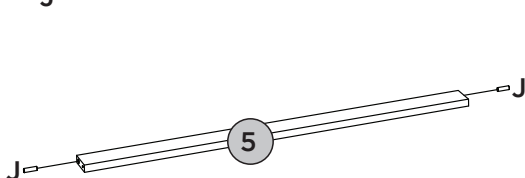
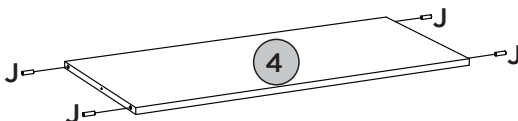
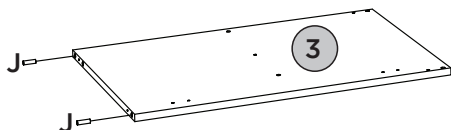
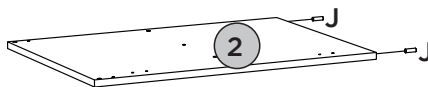
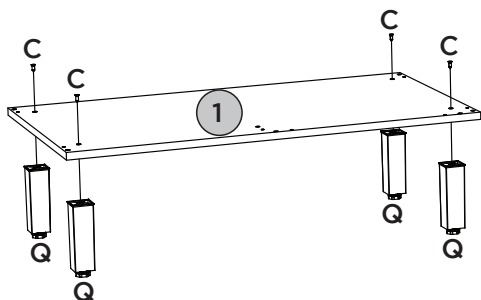
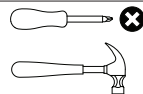

Utilizar o sachê de cola (X) em todas as cavilhas (J) do produto.



Con el pegamento sobre (X) en todos los pernos (J) producto.

Use the glue sachet (X) on all the pegs (J) of the product.

**PASSO 2****PEÇAS REQUERIDAS**

1	BASE	x1
2	LATERAL ESQUERDA	x1
3	LATERAL DIREITA	x1
4	PRATELEIRA	x1
5	PILASTRA DA PORTA	x1
6	TRAVESSA TRASEIRA	x1
7	FRENTE FIXA	x1
8	TRAVESSA FRONTAL	x1

**ACESSÓRIOS REQUERIDOS**

D			13
X			

**FERRAMENTAS NECESSÁRIAS**

Opção 01  
Opción 01  
Option 01

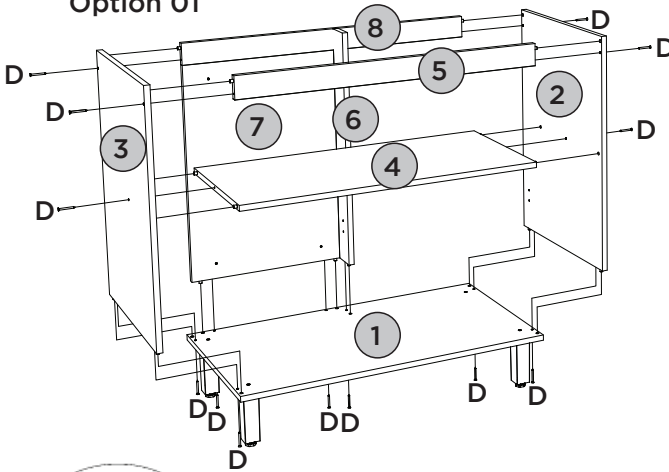

VISTA TRASEIRA

VISTA TRASERA

BACK VIEW

Opção 02  
Opción 02  
Option 02

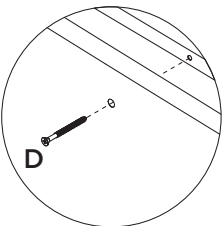
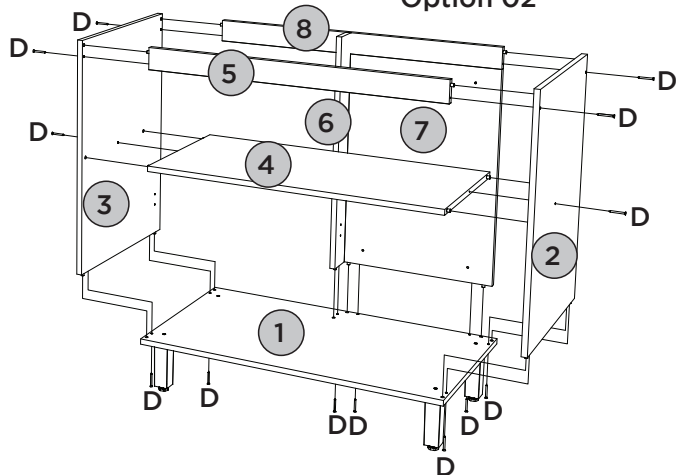

# PASSO 3

ITM/C641-

## PEÇAS REQUERIDAS

9	TRAVESSA ESTRUTURAL	x1
---	---------------------	----

## ACESSÓRIOS REQUERIDOS

F			03
I			10
M			03
N			02

## FERRAMENTAS NECESSÁRIAS

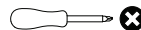

Opção 01  
Opción 01  
Option 01

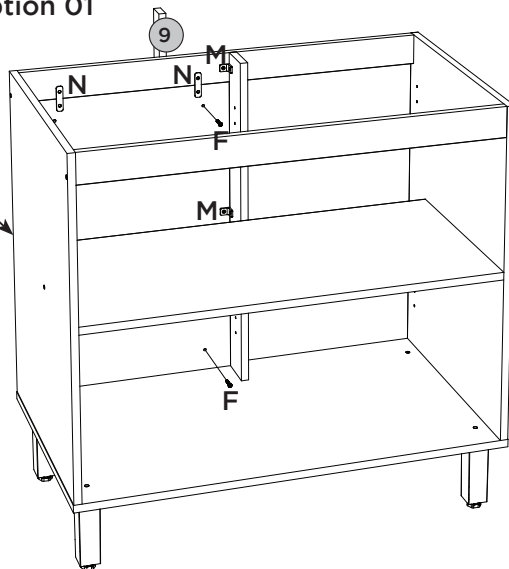
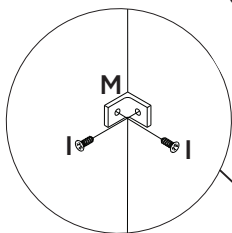

VISTA TRASEIRA  
VISTA TRASERA  
BACK VIEW

Opção 02  
Opción 02  
Option 02

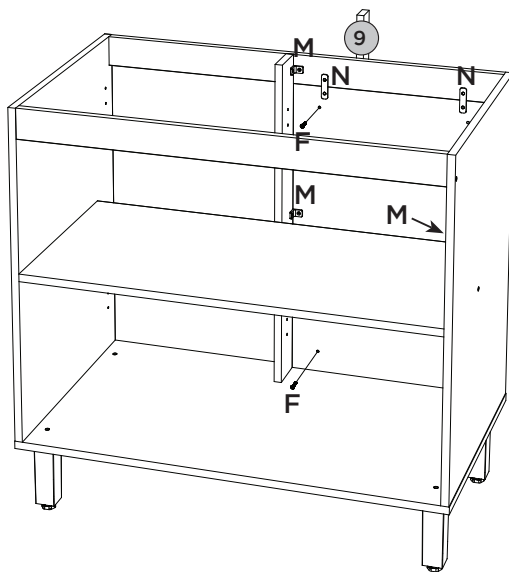
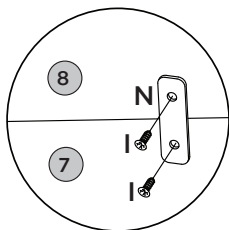

## ACESSÓRIOS REQUERIDOS



## FERRAMENTAS NECESSÁRIAS

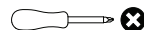

Opção 01  
Opción 01  
Option 01

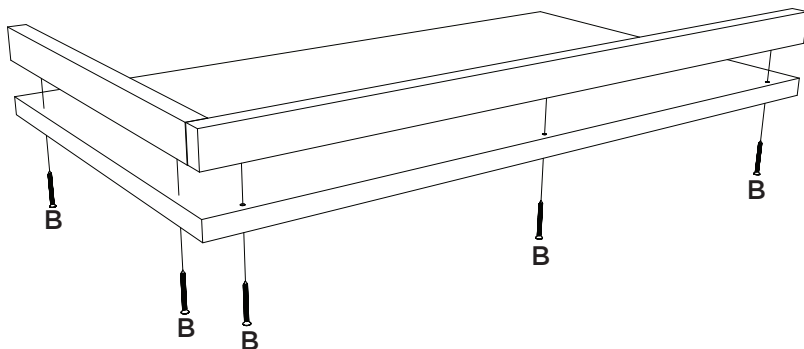

Esse tampo é opcional e é vendido separadamente (C906-128).

Esta vez es opcional y se vende por separado (C906-128).

This top is optional and is sold separately (C906-128).

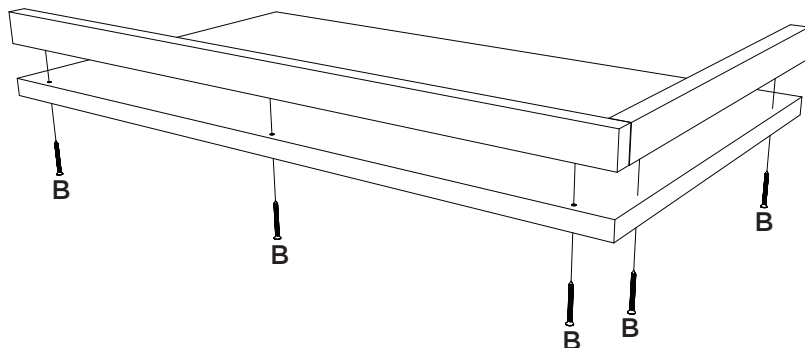

Opção 02  
Opción 02  
Option 02



**PEÇAS REQUERIDAS**

10	FUNDO	x2
----	-------	----

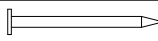
**ACESSÓRIOS REQUERIDOS**

I		16
K		27
L		07
M		04

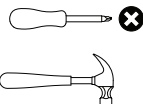
**FERRAMENTAS NECESSÁRIAS**

Fixar os pregos a uma distância de 100mm de um para outro.

Fijar las uñas a un distancia de 100mm uno a otro.

Fix the nails at a distance of 100mm from one to the other

Opção 01  
Opción 01  
Option 01

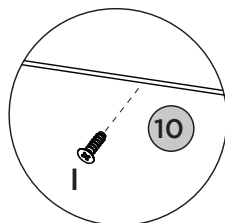
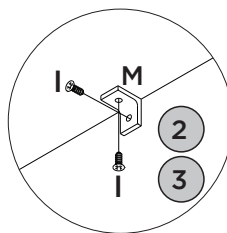
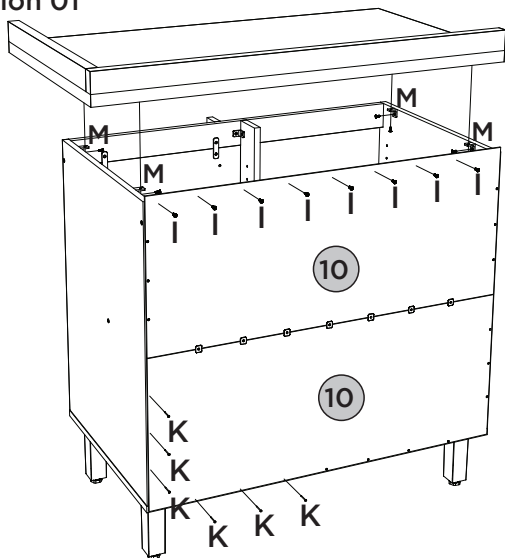

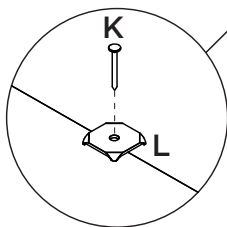
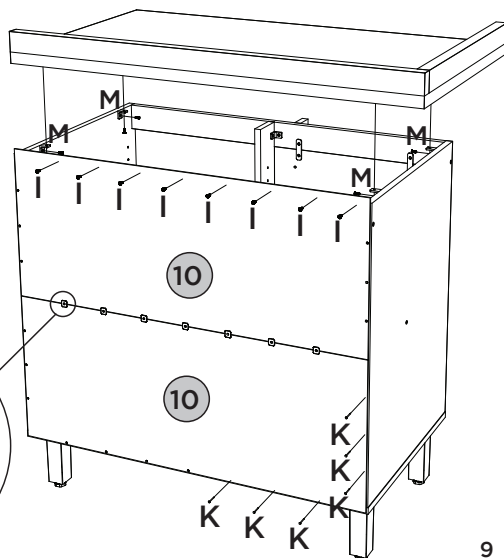

Opção 02  
Opción 02  
Option 02



**PASSO 6****PEÇAS REQUERIDAS**

11	PORTA	x1
----	-------	----

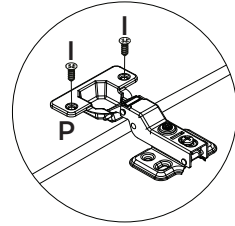
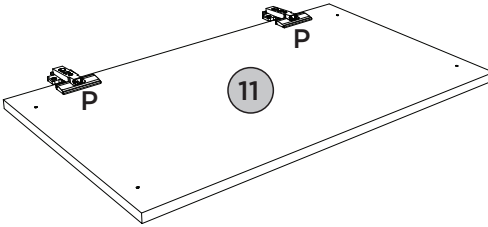
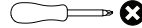

**ACESSÓRIOS REQUERIDOS**

I		04
P		02

**FERRAMENTAS NECESSÁRIAS****PASSO 7****PEÇAS REQUERIDAS**

11	PORTA	x1
----	-------	----

**ACESSÓRIOS REQUERIDOS**

E		02
I		08
O		01

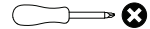
**FERRAMENTAS NECESSÁRIAS**

Para porta (11): Defina para o modo de perfuração.  
Faça a furação passante para fixar o puxador (O).

Opção 01  
Opción 01  
Option 01

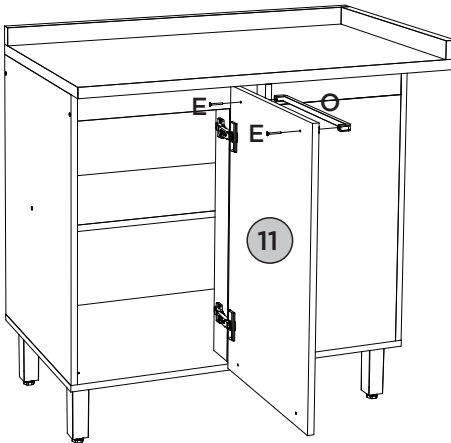

Opção 02  
Opción 02  
Option 02

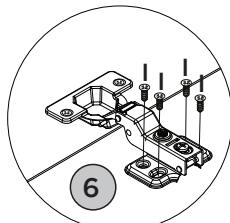
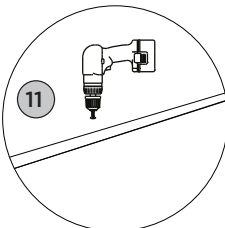
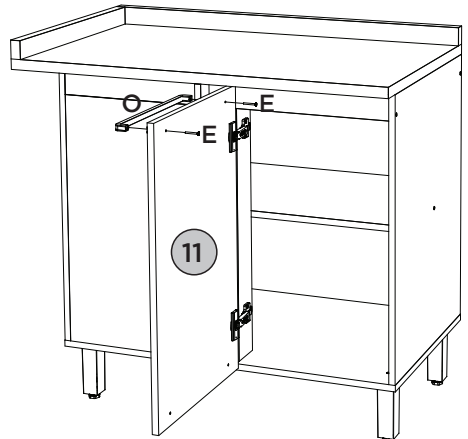

## ACESSÓRIOS REQUERIDOS

A		02	U		12
I		04	V		04
R		02	W		03
S		02	Y	<b>HENN</b>	01
T		02			

## FERRAMENTAS NECESSÁRIAS



OU

Para parede: Ajustar no modo perfuração  
Para peças (02 e 03): Usar torque 5.

Pesos máximos recomendados com carga distribuída  
Peso máximo recomendado con la carga distribuida  
Recommended maximum weight with distributed load.

PERFECT CORRECTION  
CORRECCIÓN PERFECTA

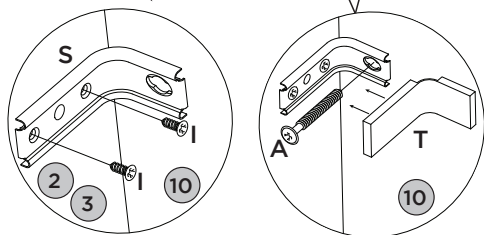
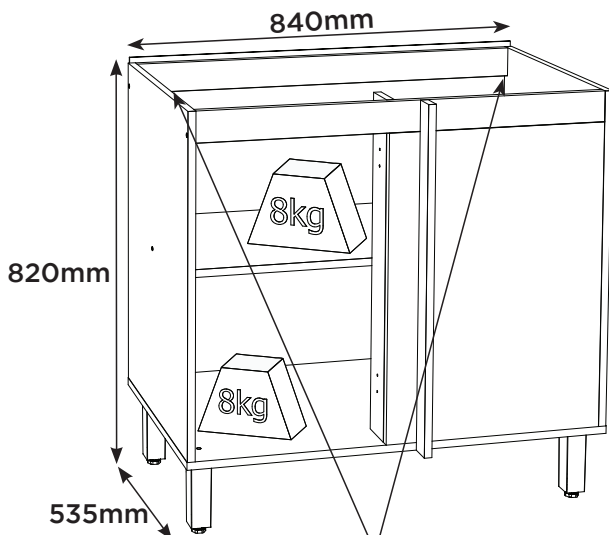
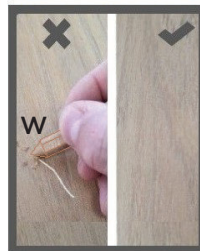

### RECOMENDAÇÃO

Para fixar o móvel na parede usar o suporte de fixação (S), o parafuso 4,0x14mm CHT (I), a Bucha 8mm (R) e o parafuso 5,0x50mm FLA (A).

### RECOMENDACIÓN

Para conectar el móvil a la pared con el soporte (S), tornillo 4,0x14mm CHT (I), el casquillo de 8 mm (R) y el 5,0 x50mm tornillo FLA (A).

### RECOMMENDATION

To fix the furniture to the wall use the fixing bracket (S), the 4,0x14mm CHT (I) screw, the 8mm bushing (R) and the 5,0x50mm FLA screw (A).

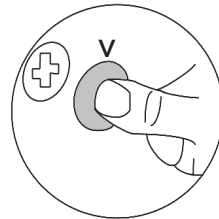
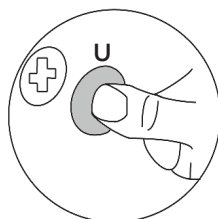

**Produto Concluído**  
**Producto terminado**  
**Finished Product**

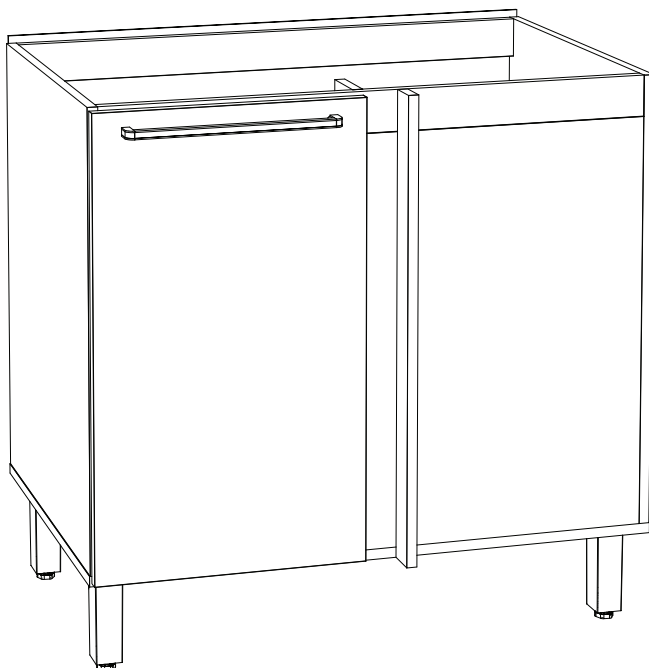





Ind. e Com. de Móveis Henn  
Mondai - SC - Brasil

+55 49 3674.3500

@moveishenn  
www.henn.com.br

# INSTRUÇÕES DE MONTAGEM

INSTRUCCIONES DE MONTAJE  
ASSEMBLY INSTRUCTIONS

## Torre Quente 02 Fornos 715mm Requite |

Torre Caliente 02 Hornos 715mm Requite | Hot Tower 02 Ovens 715mm Requite

C643-217 Nature/Areia HP  
C643-218 Nature/Nature/Areia HP

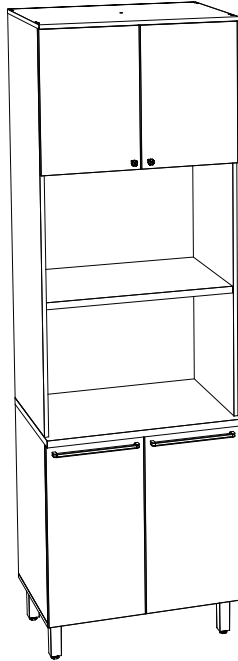

Requisitos para montagem  
Requisitos para la montaje  
Assembly Requirements

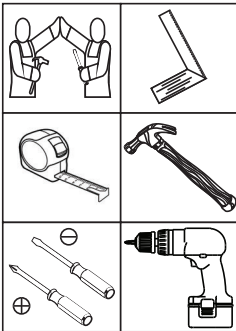

Imagens meramente ilustrativas, não acompanha o produto.  
Imágenes ilustrativas, no incluidas con el producto.  
Illustrative images, not included with the product.

### AVISO

Para limpeza de seu móvel, use uma franela seca ou umedecida, e não utilize produtos químicos que possam danificar seu produto.

### SISTEMA DE MONTAGEM

O sistema de montagem dos produtos, funciona de acordo com a ordem crescente dos números indicados no desenho. Ex: 01, 02, 03, 04... até a conclusão da montagem.

### ASSISTÊNCIA TÉCNICA

Para solicitação de Assistência Técnica você consumidor deverá entrar em contato com o Lojista o qual você realizou a compra deste produto e solicitar a assistência técnica das peças avariadas. A garantia abrange todas as peças, partes e componentes que eventualmente venham apresentar defeito de fabricação no prazo de 03 (três) meses, contando a partir da entrega do produto ao consumidor, mediante nota fiscal de compra. Se houver qualquer alteração na estrutura do produto ou ocorrer defeito por negligência do montador/consumidor em relação a instrução de montagem e manuseio, não será fornecido assistência técnica gratuita.

### ADVERTENCIA

Para limpieza de su móvil, use una franela seca o húmeda, y no utilice productos químicos que puedan dañar su producto.

### SISTEMA DE MONTAJE

El sistema de montaje de los productos funciona de acuerdo con el orden creciente de los números indicados en el dibujo. Ej.: 01, 02, 03, 04... hasta la conclusión del montaje.

### ASISTENCIA TÉCNICA

Para solicitar Asistencia Técnica, el consumidor debe comunicarse con el Comercio que usted realizó la compra de este producto y solicita asistencia técnica para las partes dañadas. La garantía cubre todas las partes, piezas y componentes que eventualmente puedan presentar defecto de fabricación en el plazo de 03 (tres) meses, contados a partir de la entrega del producto al consumidor, mediante factura de compra. Si se produce algún cambio en la estructura del producto o se produce un defecto por negligencia del montador/consumidor en relación con las instrucciones de montaje y manipulación, no se prestará asistencia técnica gratuita.

### NOTICE

To clean your furniture, use a dry or wet cloth, and do not use chemicals that may damage your product.

### ASSEMBLY SYSTEM

The products' assembly system works according to the increasing order of the indicated numbers. For example: 01, 02, 03, 04 ... to the end of the assembly.

### TECHNICAL ASSISTANCE

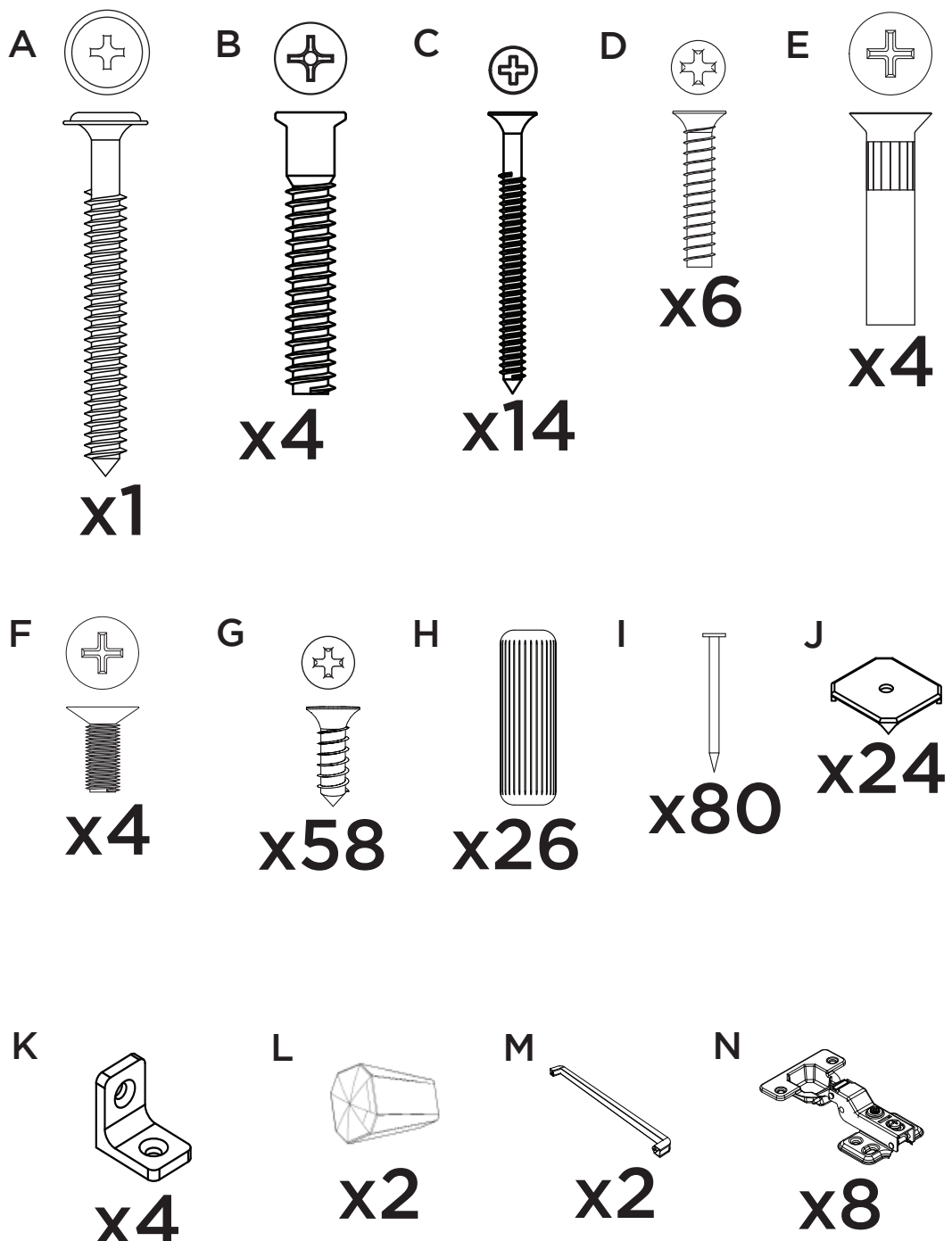

To request Technical Assistance, the consumer must contact the retailer from whom you purchased this product and request technical assistance for the damaged parts. The warranty covers all parts, parts and components that may eventually present a manufacturing defect within a period of 03 (three) months, counting from the delivery of the product to the consumer, by means of a purchase invoice. If there is any change in the structure of the product or defect occurs due to negligence of the assembler/consumer in relation to the assembly and handling instruction, free technical assistance will not be provided.

# ACESSÓRIOS | ACCESORIOS | ACCESSORIES

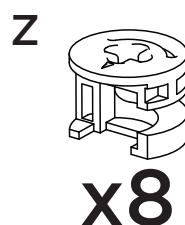
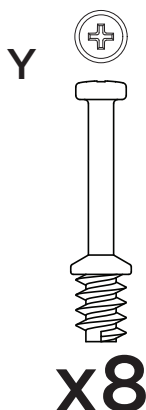
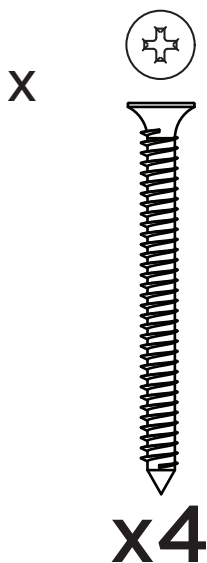
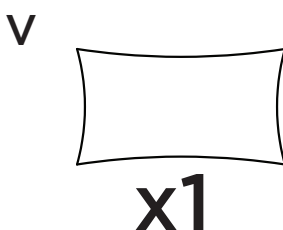
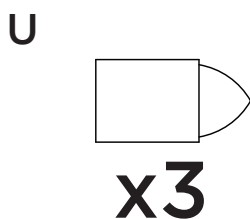
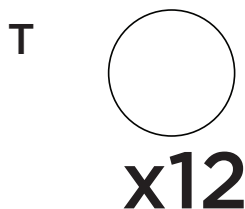
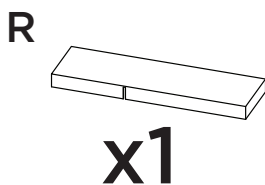
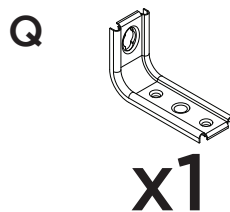
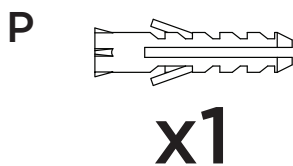
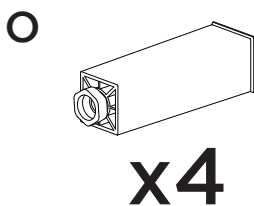

Parafusos em escala  
 Tornillos escalados  
 Scaled screws **1:1**

## ACESSÓRIOS | ACCESORIOS | ACCESSORIES

Os parafusos (E/F) devem ser usados somente quando este módulo for acoplado a outro módulo componível Henn.



Los tornillos (E/F) se debe utilizar sólo cuando el módulo está conectado a otro módulo componible Henn.



Screws (E/F) are to be used only when this module is mated to another Henn buildable module.

Parafusos em escala  
Tornillos escalados  
Scaled screws 1:1

# LISTA DE PEÇAS | LISTA DE PIEZAS | LIST OF PIECES

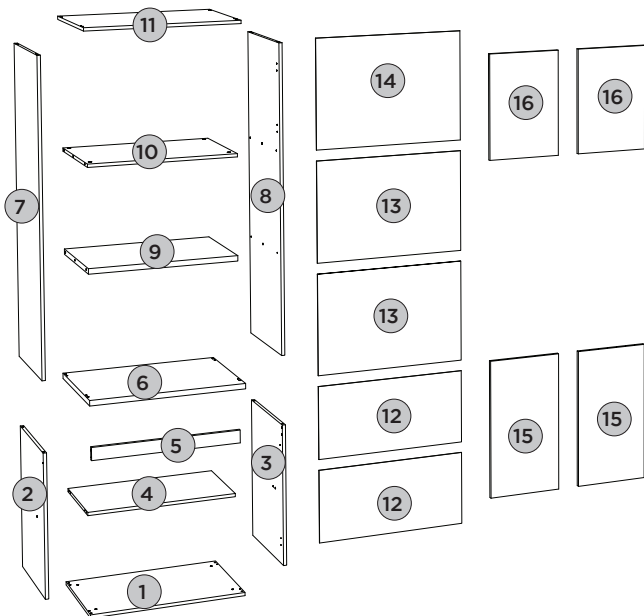

Item	Caixa Caja Box	Qty Ctd Qty	Descrição Descripción Description	Dimensões (mm)   Dimensiones (mm)		
				Comprimento Largo Length	Largura Ancho Width	Espessura Grosor Thickness
1	1/1	01	BASE   BASE   BASE	715	490	15
2	1/1	01	LATERAL ESQUERDA INFERIOR   LATERAL IZQUIERDA INFERIOR   LEFT SIDE LOWER	660	490	15
3	1/1	01	LATERAL DIREITA INFERIOR   LATERAL DERECHA INFERIOR   RIGHT SIDE LOWER	660	490	15
4	1/1	01	PRATELEIRA   ESTANTE   SHELF	684	400	15
5	1/1	01	TRAVESSA FRONTAL   TRAVESAÑO FRONTAL   FRONT CROSS-BAR	684	60	15
6	1/1	01	TAMPO 25MM   TAPA 25MM   TOP 25MM	715	533	25
7	1/1	01	LATERAL ESQUERDA SUPERIOR   LATERAL IZQUIERDA SUPERIOR   UPPER LEFT SIDE	1445	490	15
8	1/1	01	LATERAL DIREITA SUPERIOR   LATERAL DERECHA SUPERIOR   UPPER RIGHT SIDE	1445	490	15
9	1/1	01	PRATELEIRA CENTRAL   ESTANTE CENTRAL   CENTRAL SHELF	684	480	25
10	1/1	01	BASE AÉREO   BASE AEREO   AIR BASE	684	490	15
11	1/1	01	TAMPO   TAPA   TOP	715	517	15
12	1/1	02	FUNDO INFERIOR   FONDO INFERIOR   LOWER BACKGROUND	708	343	3
13	1/1	02	FUNDO CENTRAL   FONDO CENTRAL   CENTRAL FUND	708	475	3
14	1/1	01	FUNDO SUPERIOR   FONDO SUPERIOR   UPPER BACKGROUND	708	517	3
15	1/1	02	PORTA INFERIOR   PUERTA INFERIOR   LOWER DOOR	665	354	15
16	1/1	02	PORTA   PUERTA   DOOR	508	354	15





# PASSO 1

ITM/C643-

## PEÇAS REQUERIDAS

1	BASE	x1
2	LATERAL ESQUERDA INFERIOR	x1
3	LATERAL DIREITA INFERIOR	x1
4	PRATELEIRA	x1
5	TRAVESSA FRONTAL	x1

## ACESSÓRIOS REQUERIDOS

B		04
H		14
O		04
V		

## FERRAMENTAS NECESSÁRIAS

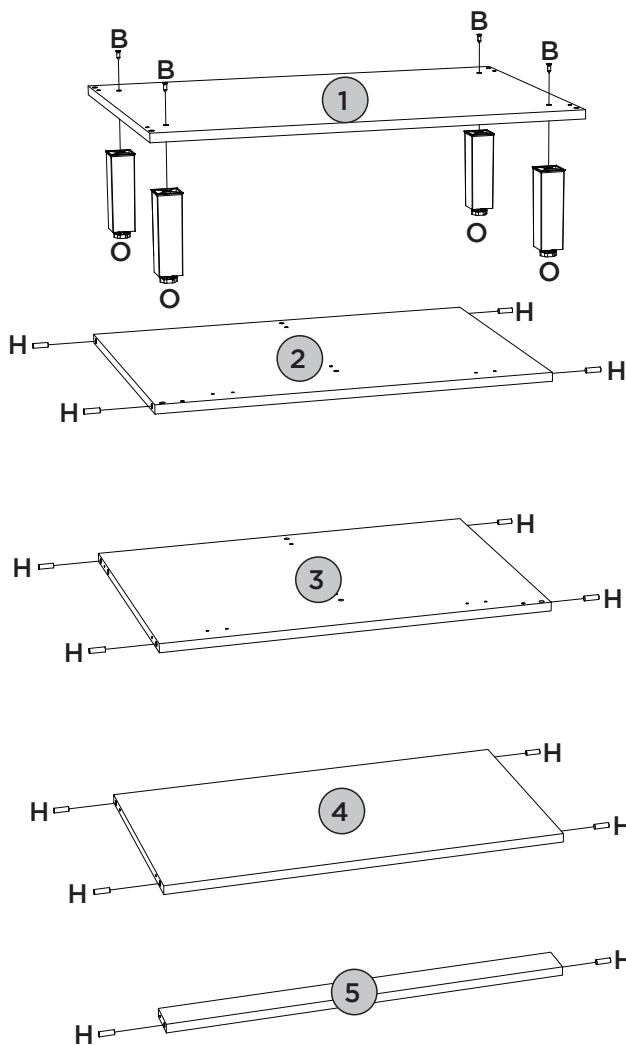
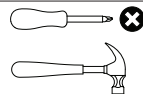

Utilizar o sachê de cola (V) em todas as cavilhas (H) do produto.

Con el pegamento sobre (V) en todos los pernos (H) producto.

Use the glue sachet (V) on all the pegs (H) of the product.



# PASSO 2

ITM/C643-

## PEÇAS REQUERIDAS

7	LATERAL ESQUERDA SUPERIOR	x1
8	LATERAL DIREITA SUPERIOR	x1
9	PRATELEIRA CENTRAL	x1
10	BASE AÉREO	x1

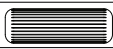
## ACESSÓRIOS REQUERIDOS

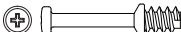
H		12
V		
Y		08

## FERRAMENTAS NECESSÁRIAS

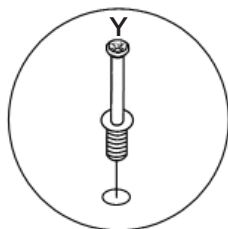
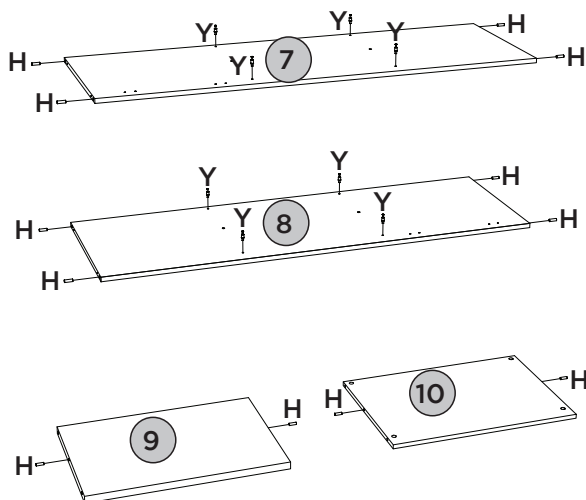
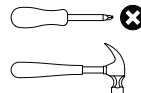



# PASSO 3

## PEÇAS REQUERIDAS

1	BASE	x1
2	LATERAL ESQUERDA INFERIOR	x1
3	LATERAL DIREITA INFERIOR	x1
4	PRATELEIRA	x1
5	TRAVESSA FRONTAL	x1

## ACESSÓRIOS REQUERIDOS

C		10
V		



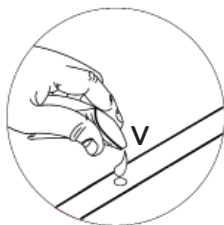
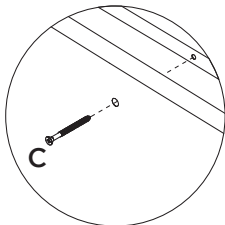
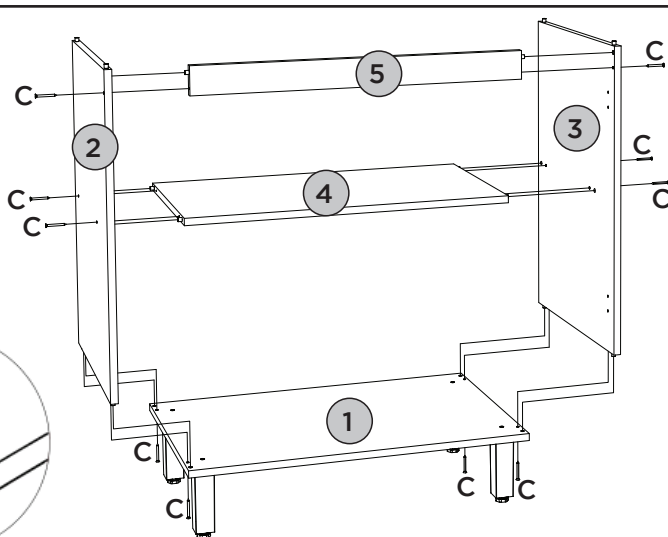

## FERRAMENTAS NECESSÁRIAS



**PEÇAS REQUERIDAS**

6	TAMPO 25MM	x1
7	LATERAL ESQUERDA SUPERIOR	x1
8	LATERAL DIREITA SUPERIOR	x1
9	PRATELEIRA CENTRAL	x1
10	BASE AÉREO	x1
11	TAMPO	x1

**ACESSÓRIOS REQUERIDOS**

C		04
V		
X		04
Z		08

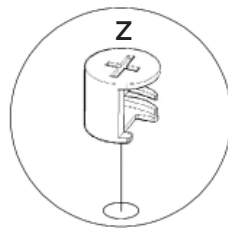
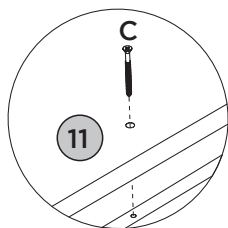
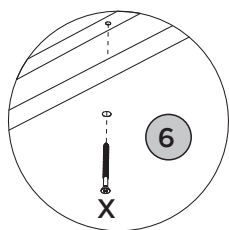
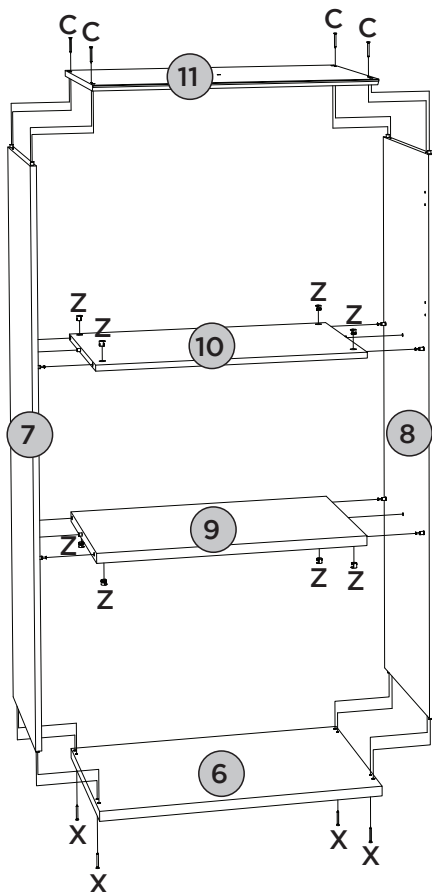
**FERRAMENTAS NECESSÁRIAS**

# PASSO 5

ITM/C643-

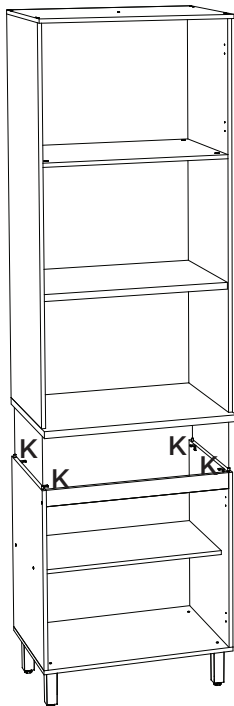

## ACESSÓRIOS REQUERIDOS

G		08
K		04
V		

## FERRAMENTAS NECESSÁRIAS

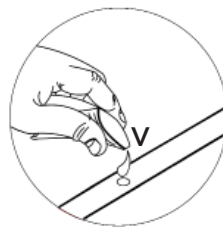
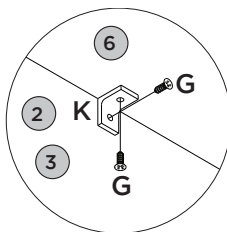
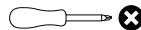

# PASSO 6

## PEÇAS REQUERIDAS

12	FUNDO INFERIOR	x2
13	FUNDO CENTRAL	x2
14	FUNDO SUPERIOR	x1

## ACESSÓRIOS REQUERIDOS

I		80
J		24

## FERRAMENTAS NECESSÁRIAS

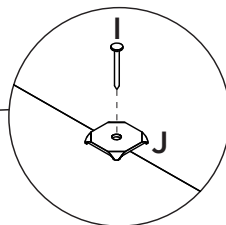
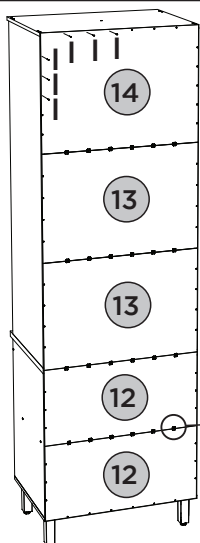
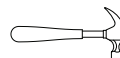

Fixar os pregos a uma distância de 100mm de um para outro.

Fijar las uñas a un distancia de 100mm uno a otro.

Fix the nails at a distance of 100mm from one to the other



## PEÇAS REQUERIDAS

15	PORTA INFERIOR	x2
16	PORTA	x2

## ACESSÓRIOS REQUERIDOS

G		16
N		08



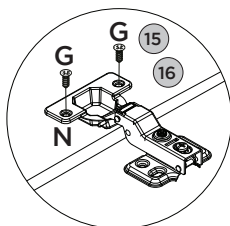
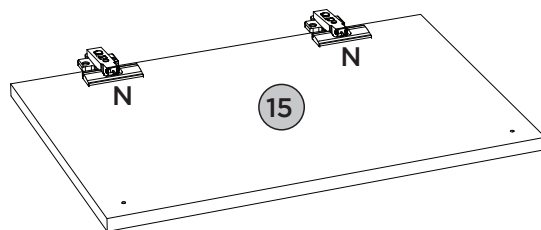
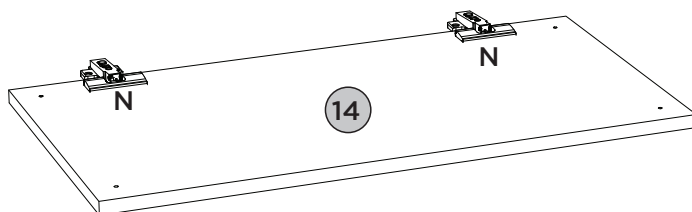
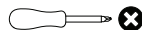



## FERRAMENTAS NECESSÁRIAS



## PEÇAS REQUERIDAS

15	PORTA INFERIOR	x2
16	PORTA	x2

## ACESSÓRIOS REQUERIDOS

D	 	06
G	 	32
L		02
M		02

## FERRAMENTAS NECESSÁRIAS

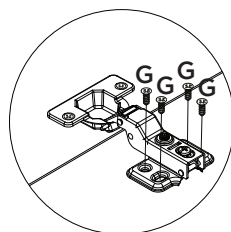
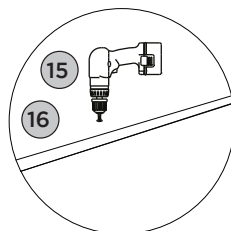
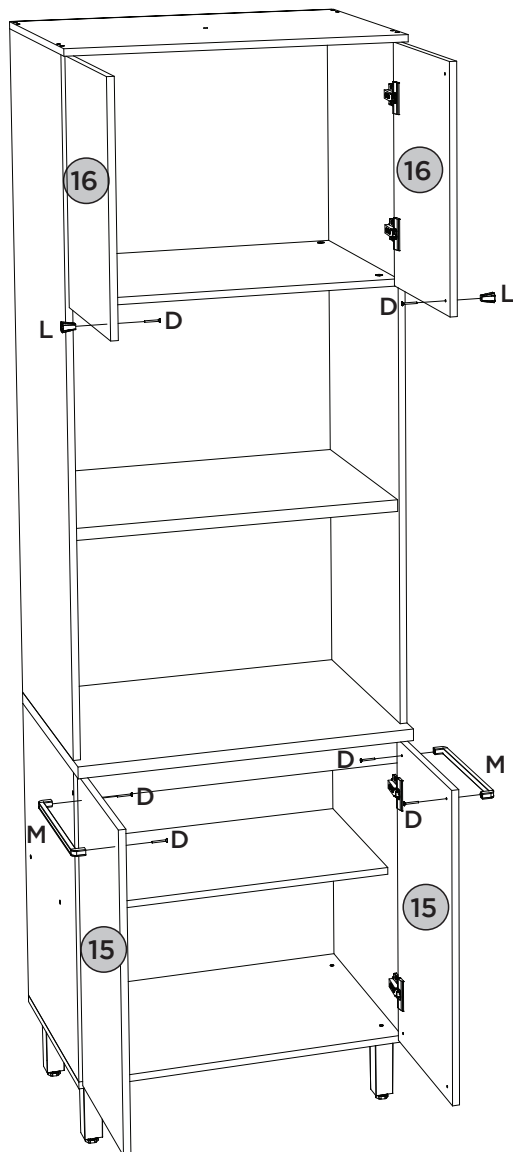
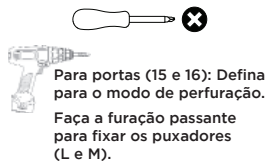

ACESSÓRIOS REQUERIDOS

A		01	S		16
G		02	T		12
P		01	U		03
Q		01	W		01
R		01			

FERRAMENTAS NECESSÁRIAS

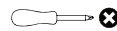

OU



Para parede: Ajustar no modo perfuração  
Para peça (11): Usar torque 5

Pesos máximos recomendados com carga distribuída  
Peso máximo recomendado con la carga distribuida  
Recommended maximum weight with distributed load.

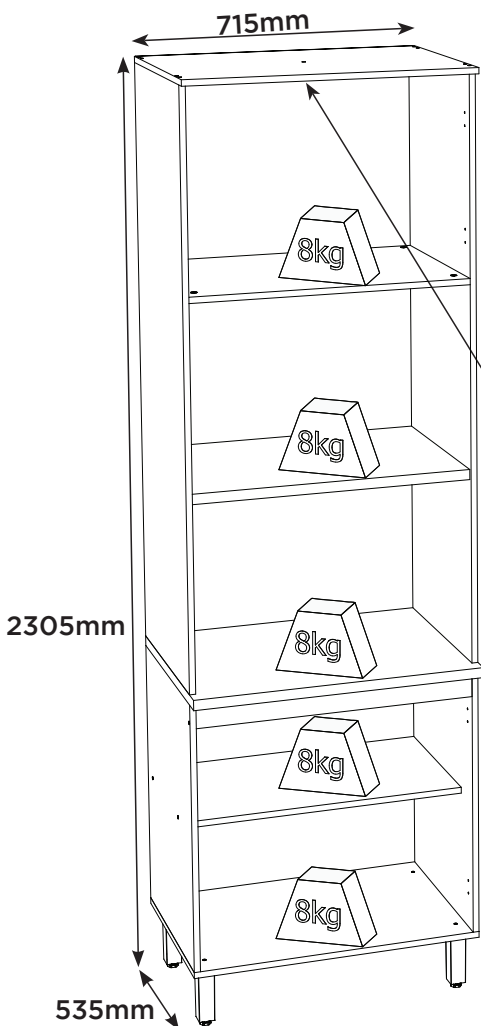

PERFECT CORRECTION  
CORRECCIÓN PERFECTA

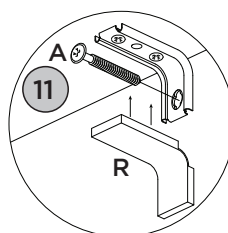
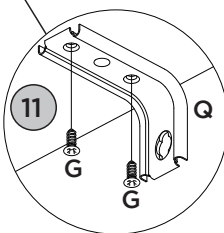
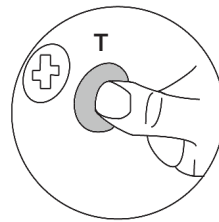
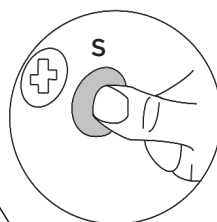
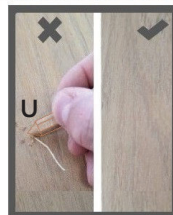

RECOMENDAÇÃO

Para fixar o móvel na parede usar o suporte de fixação (Q), o parafuso 4,0x14mm CHT (G), a Bucha 8mm (P) e o parafuso 5,0x50mm FLA (A).

RECOMENDACIÓN

Para conectar el móvil a la pared con el soporte (Q), tornillo 4,0x14mm CHT (G), el casquillo de 8 mm (P) y el 5,0 x50mm tornillo FLA (A).

RECOMMENDATION

To fix the furniture to the wall use the fixing bracket (Q), the 4,0x14mm CHT (G) screw, the 8mm bushing (P) and the 5.0x50mm FLA screw (A).

**Produto Concluído**  
**Producto terminado**  
**Finished Product**

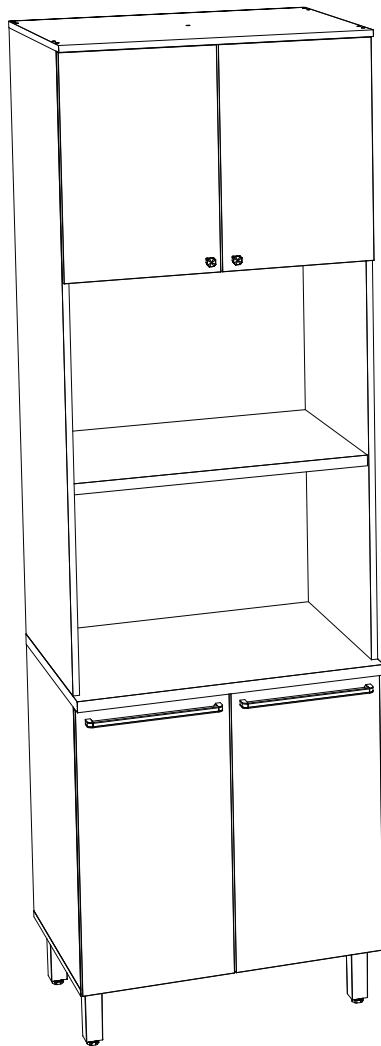
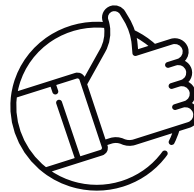

**HENN**Ind. e Com. de Móveis Henn  
Mondai - SC - Brasil

☎ +55 49 3674.3500

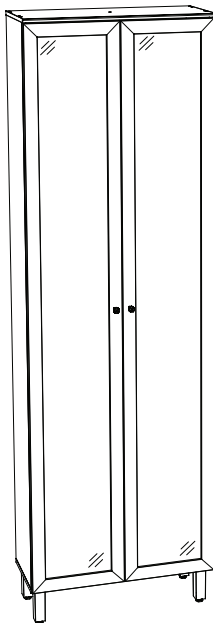
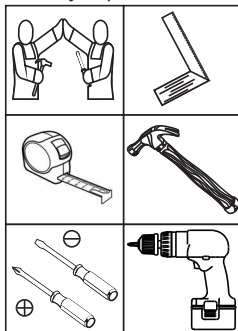
📷 📱 @moveishenn  
www.henn.com.br**INSTRUÇÕES DE  
MONTAGEM**INSTRUCCIONES DE MONTAJE  
ASSEMBLY INSTRUCTIONS**Cristaleira 02 Portas Requite |  
Gabinete 02 Puertas Requite | Cabinet 02 Doors Requite****C645-128 Nature  
C645-217 Nature/Areia HP****Requisitos para montagem  
Requisitos para la montaje  
Assembly Requirements**

Imagens meramente ilustrativas,  
não acompanha o produto.  
Imágenes ilustrativas, no incluidas  
con el producto.  
Illustrative images, not included  
with the product.

**AVISO**

Para limpeza de seu móvel, use uma flanela seca ou umedecida, e não utilize produtos químicos que possam danificar seu produto.

**SISTEMA DE MONTAGEM**

O sistema de montagem dos produtos, funciona de acordo com a ordem crescente dos números indicados no desenho. Ex: 01, 02, 03, 04... até a conclusão da montagem.

**ASSISTÊNCIA TÉCNICA**

Para solicitação de Assistência Técnica você consumidor deverá entrar em contato com o Lojista a qual você realizou a compra deste produto e solicitar a assistência técnica das peças avariadas. A garantia abrange todas as peças, partes e componentes que eventualmente venham apresentar defeito de fabricação no prazo de 03 (três) meses, contando a partir da entrega do produto ao consumidor, mediante nota fiscal de compra. Se houver qualquer alteração na estrutura do produto ou ocorrer defeito por negligência do montador/consumidor em relação a instrução de montagem e manuseio, não será fornecido assistência técnica gratuita.

**ADVERTENCIA**

Para limpieza de su móvil, use una flanela seca o húmeda, y no utilice productos químicos que puedan dañar su producto.

**SISTEMA DE MONTAJE**

El sistema de montaje de los productos funciona de acuerdo con el orden creciente de los números indicados en el dibujo. Ej.: 01, 02, 03, 04... hasta la conclusión del montaje.

**ASISTENCIA TÉCNICA**

Para solicitar Asistencia Técnica, el consumidor debe comunicarse con el Comercio que usted realizó la compra de este producto y solicita asistencia técnica para las partes dañadas. La garantía cubre todas las partes, piezas y componentes que eventualmente puedan presentar defecto de fabricación en el plazo de 03 (tres) meses, contados a partir de la entrega del producto al consumidor, mediante factura de compra. Si se produce algún cambio en la estructura del producto o se produce un defecto por negligencia del montador/consumidor en relación con las instrucciones de montaje y manipulación, no se prestará asistencia técnica gratuita.

**NOTICE**

To clean your furniture, use a dry or wet cloth, and do not use chemicals that may damage your product.

**ASSEMBLY SYSTEM**

The products' assembly system works according to the increasing order of the indicated numbers. For example: 01, 02, 03, 04 ... to the end of the assembly.

**TECHNICAL ASSISTANCE**

To request Technical Assistance, the consumer must contact the retailer from whom you purchased this product and request technical assistance for the damaged parts. The warranty covers all parts, parts and components that may eventually present a manufacturing defect within a period of 03 (three) months, counting from the delivery of the product to the consumer, by means of a purchase invoice. If there is any change in the structure of the product or defect occurs due to negligence of the assembler/consumer in relation to the assembly and handling instruction, free technical assistance will not be provided.

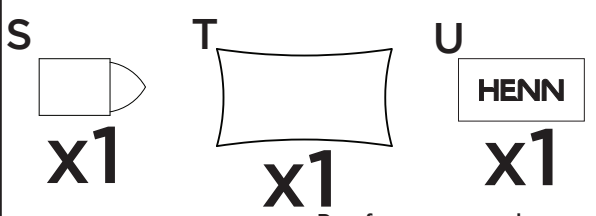
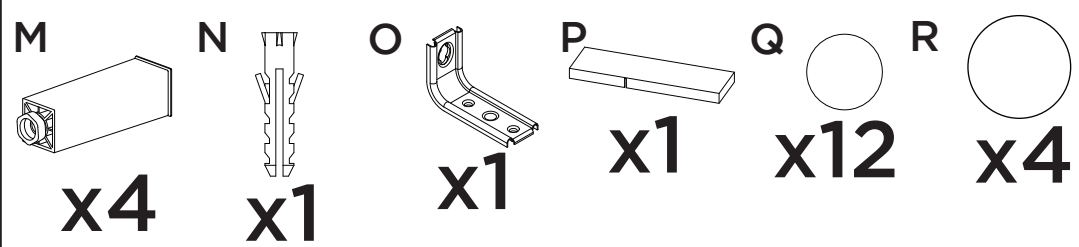
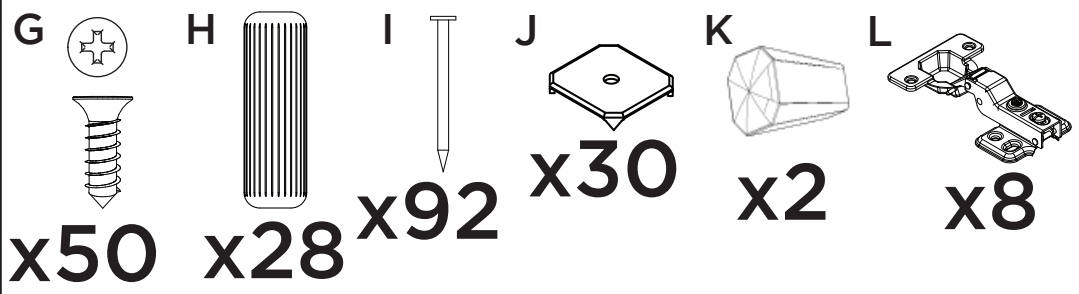
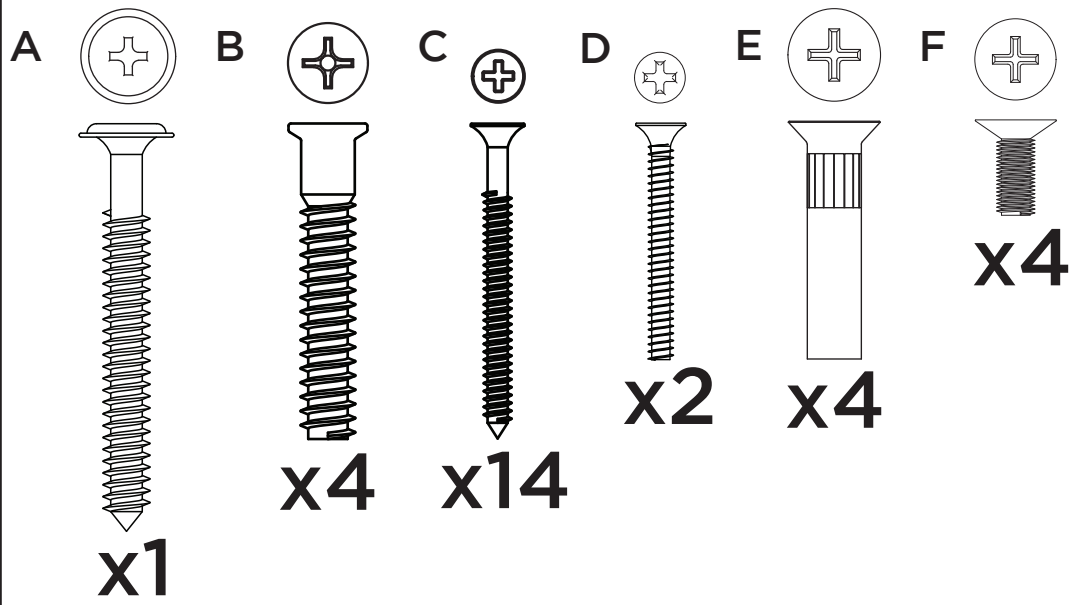

Parafusos em escada  
Tornillos escalados  
Scaled screws 1:1

Os parafusos (E/F) devem ser usados somente quando este módulo for acoplado a outro módulo componível Henn.

Los tornillos (E/F) se debe utilizar sólo cuando el módulo está conectado a otro módulo componible Henn.

Screws (E/F) are to be used only when this module is mated to another Henn buildable module.

## LISTA DE PEÇAS | LISTA DE PIEZAS | LIST OF PIECES

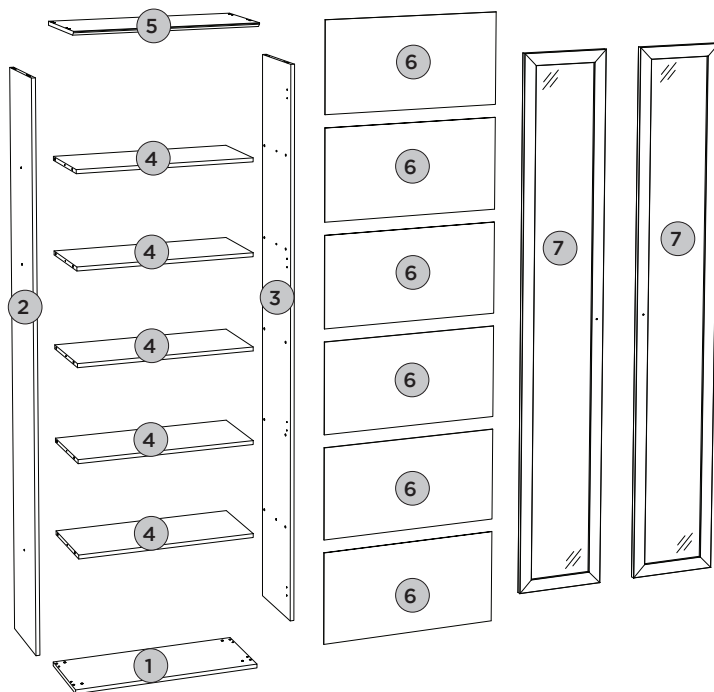





Item	Caja Caja Box	Qty Ctd Qty	Descrição Descripción Description	Dimensões (mm)   Dimensiones (mm)   Dimensions (mm)		
				Comprimento Largo Length	Largura Ancho Width	Espessura Grosor Thickness
1	1/2	01	BASE   BASE   BASE	715	295	15
2	2/2	01	LATERAL ESQUERDA   LATERAL IZQUIERDA   LEFT SIDE	2130	295	15
3	2/2	01	LATERAL DIREITA   LATERAL DERECHA   RIGHT SIDE	2130	295	15
4	1/2	05	PRATELEIRA   ESTANTE   SHELF	684	295	15
5	1/2	01	TAMPO   TAPA   TOP	715	322	15
6	2/2	06	FUNDO   FONDO   BOTTOM	708	358	3
7	2/2	02	PORTA DE VIDRO TEMPERADA REFLECTA   PUERTA DE VIDRIO TEMPLADO REFLECTANTE   REFLECT TEMPERED GLASS DOOR	2137	354	15

# PASSO 1

## PEÇAS REQUERIDAS

1	BASE	x1
2	LATERAL ESQUERDA	x1
3	LATERAL DIREITA	x1
4	PRATELEIRA	x5

## ACESSÓRIOS REQUERIDOS

B		04
H		28
M		04
T		

## FERRAMENTAS NECESSÁRIAS

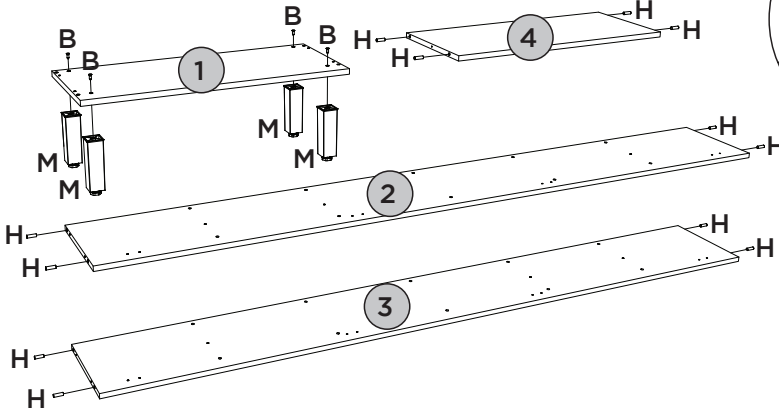
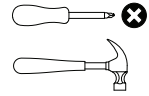

Utilizar o sachê de cola (T) em todas as cavilhas (H) do produto.

Con el pegamento sobre (T) en todos los pernos (H) producto.



Use the glue sachet (T) on all the pegs (H) of the product.

# PASSO 2

## PEÇAS REQUERIDAS

1	BASE	x1
2	LATERAL ESQUERDA	x1
3	LATERAL DIREITA	x1
4	PRATELEIRA	x5
5	TAMPO	x1

## ACESSÓRIOS REQUERIDOS

C		14
T		

## FERRAMENTAS NECESSÁRIAS

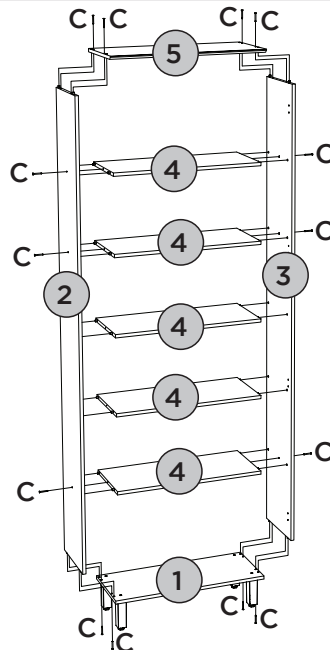
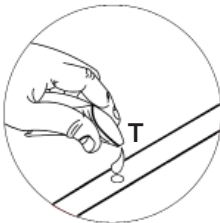
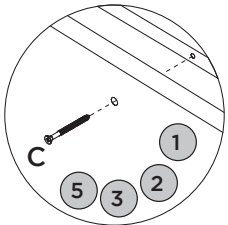
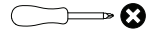





## PEÇAS REQUERIDAS

6	FUNDO	x6
---	-------	----

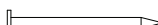
## ACESSÓRIOS REQUERIDOS

I		92
J		30

## FERRAMENTAS NECESSÁRIAS

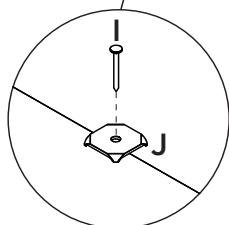
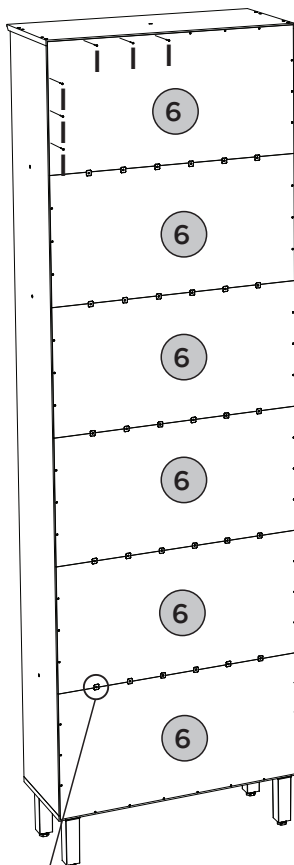
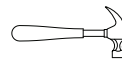

Fixar os pregos a uma distância de 100mm de um para outro.

Fijar las uñas a un distancia de 100mm uno a otro.

Fix the nails at a distance of 100mm from one to the other





# PASSO 4

ITM/C645-

## PEÇAS REQUERIDAS

7	PORTA DE VIDRO TEMPERADA REFLECTA	x2
---	--------------------------------------	----

## ACESSÓRIOS REQUERIDOS

D		02
G		16
K		02
L		08

## FERRAMENTAS NECESSÁRIAS

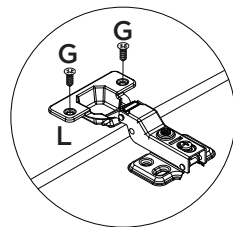
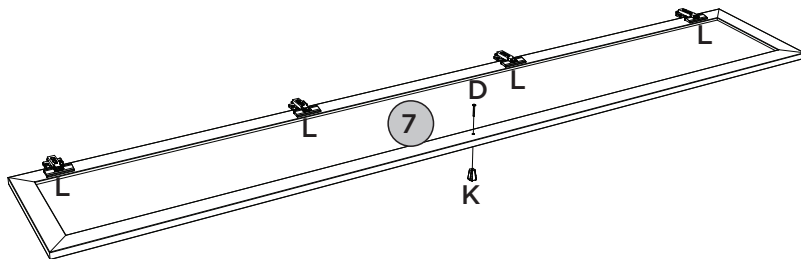
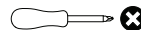

# PASSO 5

## PEÇAS REQUERIDAS

7	PORTA DE VIDRO TEMPERADA REFLECTA	x2
---	--------------------------------------	----

## ACESSÓRIOS REQUERIDOS

G		32
---	---	----

## FERRAMENTAS NECESSÁRIAS

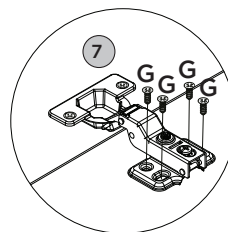
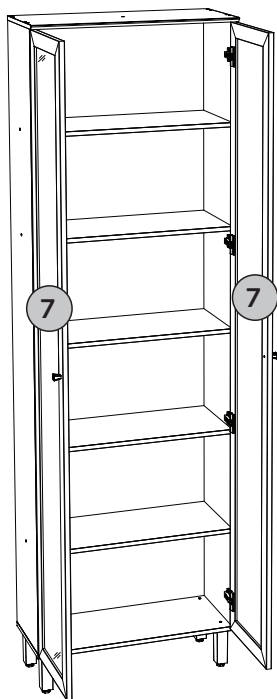
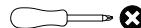

ACESSÓRIOS REQUERIDOS

A		01
G		02
N		01
O		01
P		01

Q		12
R		04
S		01
U		01

FERRAMENTAS NECESSÁRIAS



Para parede: Ajustar no modo perfuração  
Para peça (5): Usar torque 5

Pesos máximos recomendados com carga distribuída  
Peso máximo recomendado con la carga distribuida  
Recommended maximum weight with distributed load.

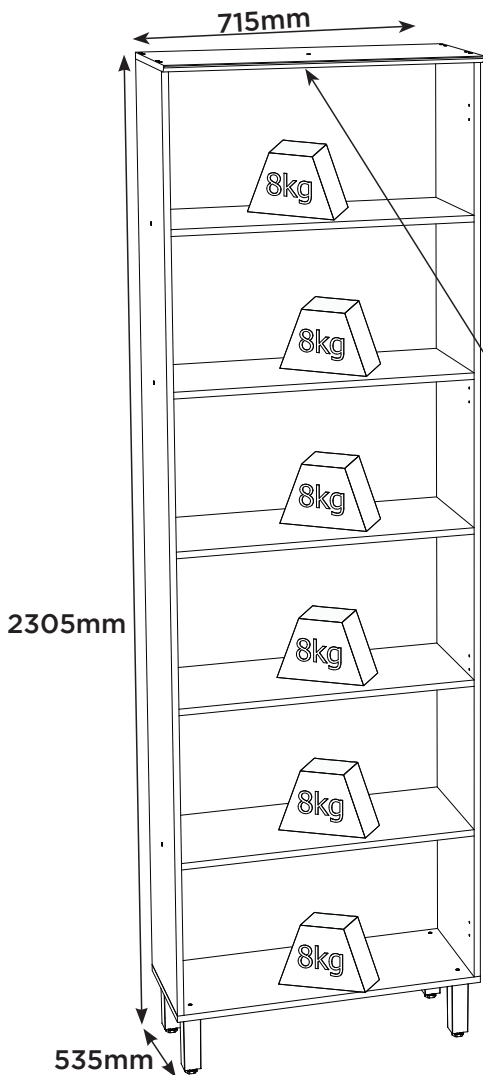

PERFECT CORRECTION  
CORRECCIÓN PERFECTA

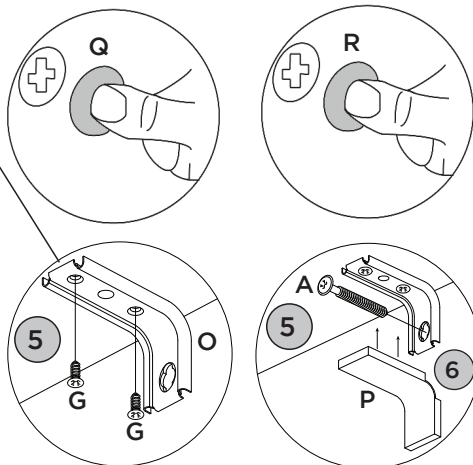
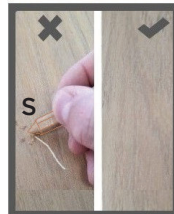

RECOMENDAÇÃO

Para fixar o móvel na parede usar o suporte de fixação (O), o parafuso 4,0x14mm CHT (G), a Bucha 8mm (N) e o parafuso 5,0x50mm FLA (A).

RECOMENDACIÓN

Para conectar el móvil a la pared con el soporte (O), tornillo 4,0x14mm CHT (G), el casquillo de 8 mm (N) y el 5,0 x50mm tornillo FLA (A).

RECOMMENDATION

To fix the furniture to the wall use the fixing bracket (O), the 4,0x14mm CHT (G) screw, the 8mm bushing (N) and the 5.0x50mm FLA screw (A).

**Produto Concluído**  
**Producto terminado**  
**Finished Product**

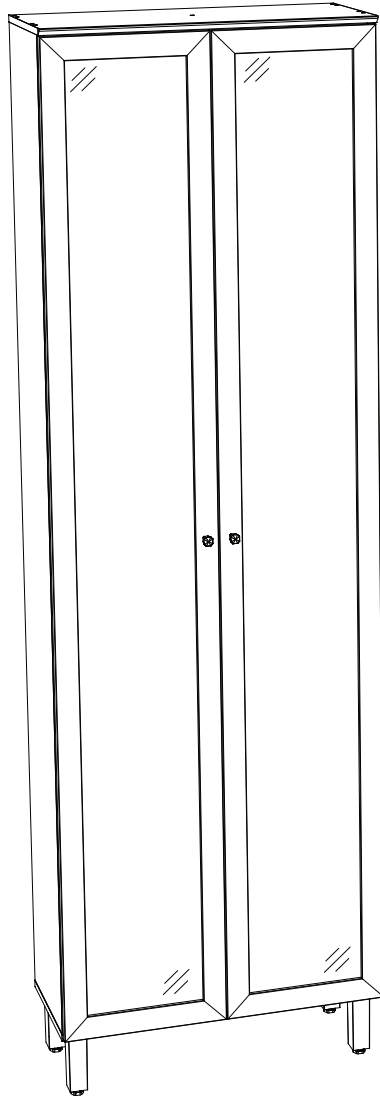
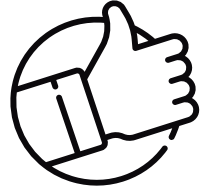

**HENN**Ind. e Com. de Móveis Henn  
Mondai - SC - Brasil

☎ +55 49 3674.3500

📧 @moveishenn  
www.henn.com.br**INSTRUÇÕES DE MONTAGEM**INSTRUCCIONES DE MONTAJE  
ASSEMBLY INSTRUCTIONS**Tampo para Balcão 400mm | Tablero para Balcón 400mm | Counter Top 400mm**

- C902-23 - Duna
- C902-33 - Nero
- C902-114 - Calcare

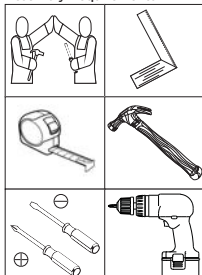
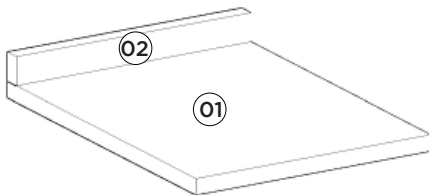
Requisitos para montagem  
Requisitor para la montaje  
Assembly RequirementsImagens meramente ilustrativas  
Imágenes meramente ilustrativas  
Images for illustration only**AVISO**

Para limpeza de seu móvel, use uma flanela seca ou umedecida, e não utilize produtos químicos que possam danificar seu produto.

**SISTEMA DE MONTAGEM**

O sistema de montagem dos produtos, funciona de acordo com a ordem crescente dos números indicados no desenho. Ex: 01, 02, 03, 04... até a conclusão da montagem.

**ADVERTENCIA**

Para limpieza de su móvil, use una franela seca o húmeda, y no utilice productos químicos que puedan dañar su producto.

**Lista de Peças | Lista de piezas | List of parts**

Item	Caixa Caja Box	Qtd Ctd Qty	Descrição   Descripción   Description	Medidas (mm)   Dimensions (mm)   Size (measure- ments) (mm)
01	1/1	01	Tampo   Tapa   Top	533x400x25
02	1/1	01	Rodatampo   Rodatampo   Rodatampo	400x45x25

**SISTEMA DE MONTAJE**

El sistema de montaje de los productos funciona de acuerdo con el orden creciente de los números indicados en el dibujo. Ej.: 01, 02, 03, 04... hasta la conclusión del montaje.

**NOTICE**

To clean your furniture, use a dry or wet cloth, and do not use chemicals that may damage your product.

**Ferragens | Herrajes | Hardware**

<b>A</b>	02x	<b>B</b>	08x	<b>C</b>	04x
Parafuso 4,5x50mm CHT. Tornillo 4,5x50mm CHT. Screw 4,5x50mm CHT.		Parafuso 3,5x14mm FLA. Tornillo 3,5x14mm FLA. Screw 3,5x14mm FLA.		Cantoneira plástica Cantoneira plástica Plastic angle brackets	

Estas ferragens constam no Pacote do respectivo Balcão.  
Estos herrajes constan en el Paquete del respectivo Balcón.  
These hardware are included in the Package of the respective Counter.

**ASSEMBLY SYSTEM**

The products' assembly system works according to the increasing order of the indicated numbers. For example: 01, 02, 03, 04 ... to the end of the assembly.

Esse tampo é opcional e é vendido separadamente

Esta vez es opcional y se vende por separado

This top is optional and is sold separately

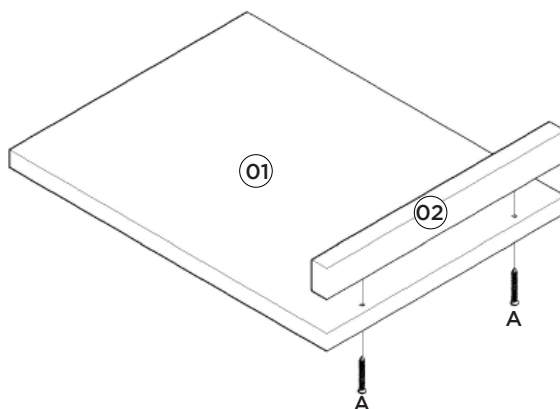

Exemplo de como fixar o Tampo no produto.

Ejemplo de la fijación de la tapa sobre el producto.

Example of fixing the lid on the product.

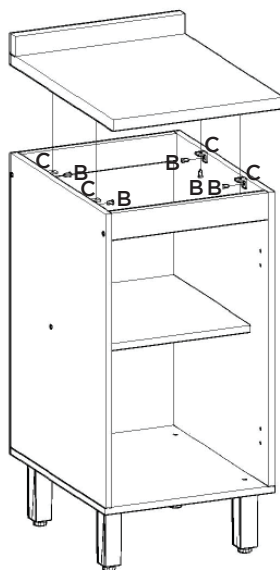

**HENN**Ind. e Com. de Móveis Henn  
Mondai - SC - Brasil

☎+55 49 3674.3500

📧📱@moveishenn  
www.henn.com.br**INSTRUÇÕES DE MONTAGEM**INSTRUCCIONES DE MONTAJE  
ASSEMBLY INSTRUCTIONS**Tampo para Balcão Canto Reto | Tapa para Balcón Canto Reto | Straight Corner Counter Top**

- C906-23 Duna
- C906-33 Nero
- C906-114 Calcare

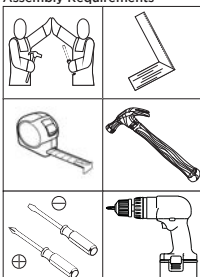
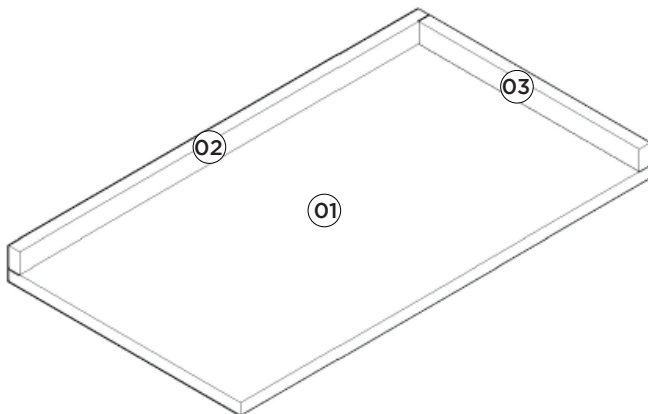
Requisitos para montagem  
Requisitor para la montaje  
Assembly RequirementsImagens meramente ilustrativas  
Imágenes meramente ilustrativas  
Images for illustration only**AVISO**

Para limpeza de seu móvel, use uma flanela seca ou umedecida, e não utilize produtos químicos que possam danificar seu produto.

**SISTEMA DE MONTAGEM**

O sistema de montagem dos produtos, funciona de acordo com a ordem crescente dos números indicados no desenho. Ex: 01, 02, 03, 04... até a conclusão da montagem.

**ADVERTENCIA**

Para limpieza de su móvil, use una franela seca o húmeda, y no utilice productos químicos que puedan dañar su producto.

**SISTEMA DE MONTAJE**

El sistema de montaje de los productos funciona de acuerdo con el orden creciente de los números indicados en el dibujo. Ej.: 01, 02, 03, 04... hasta la conclusión del montaje.

**NOTICE**

To clean your furniture, use a dry or wet cloth, and do not use chemicals that may damage your product.

**ASSEMBLY SYSTEM**

The products' assembly system works according to the increasing order of the indicated numbers. For example: 01, 02, 03, 04 ... to the end of the assembly.

**Lista de Peças | Lista de piezas | List of parts**

Item	Caixa Caja Box	Qtd Ctd Qty	Descrição   Descripción   Description	Medidas (mm)   Dimensions (mm)   Size (measure- ments) (mm)
01	1/1	01	Tampo   Tapa   Top	940x533x25
02	1/1	01	Rodatampo Maior   Rodatampo Mayor   Largest Rodatampo	940x45x25
03	1/1	01	Rodatampo Menor   Rodatampo Menor   Rodatampo Minor	508x45x25

**Ferragens | Herrajes | Hardware**

**A** 05x  
  
 Parafuso 4,5x50mm CHT.  
 Tornillo 4,5x50mm CHT.  
 Screw 4,5x50mm CHT.

**B** 08x  
  
 Parafuso 3,5x14mm FLA.  
 Tornillo 3,5x14mm FLA.  
 Screw 3,5x14mm FLA.

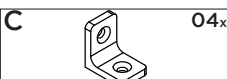
**C** 04x  
  
 Cantoneira plástica  
 Cantonera plástica  
 Plastic angle brackets

 Estas ferragens constam no Pacote do respectivo Balcão.  
 Estos herrajes constan en el Paquete del respectivo Balcón.  
 These hardware are included in the Package of the respective Counter.

Esse tampo é opcional e é vendido separadamente

Esta vez es opcional y se vende por separado

This top is optional and is sold separately

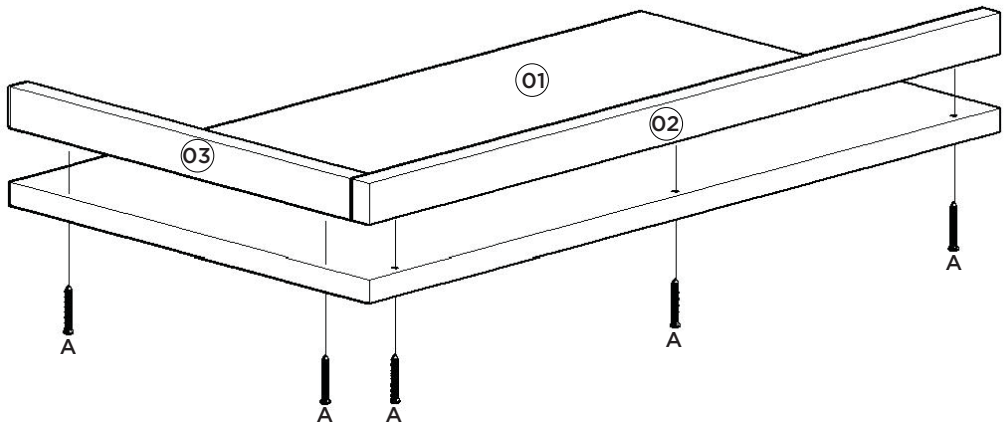

Exemplo de como fixar o Tampo no produto.

Ejemplo de la fijación de la tapa sobre el producto.

Example of fixing the lid on the product.

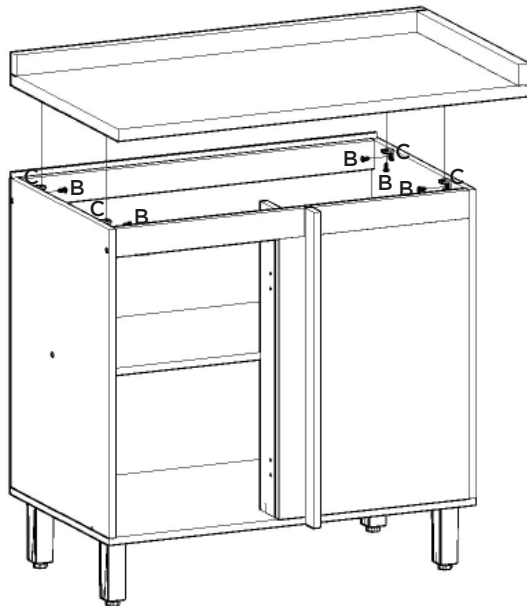



**HENN**Ind. e Com. de Móveis Henn  
Mondai - SC - Brasil

☎ +55 49 3674.3500

📧 @moveishenn  
www.henn.com.br**INSTRUÇÕES DE MONTAGEM**INSTRUCCIONES DE MONTAJE  
ASSEMBLY INSTRUCTIONS**Tampo Cooktop 800mm | Tampo Cooktop 800mm | Cooktop top 800mm**

- C908-23 Duna
- C908-33 Nero
- C908-114 Calcare

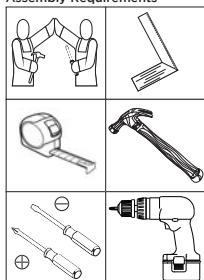
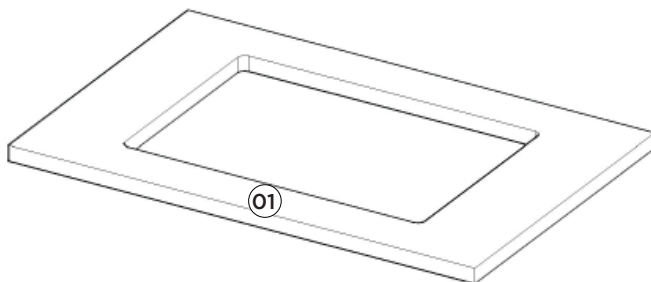
Requisitos para montagem  
Requisitor para la montaje  
Assembly RequirementsImagens meramente ilustrativas  
Imágenes meramente ilustrativas  
Images for illustration only**AVISO**

Para limpeza de seu móvel, use uma flanela seca ou umedecida, e não utilize produtos químicos que possam danificar seu produto.

**SISTEMA DE MONTAGEM**

O sistema de montagem dos produtos, funciona de acordo com a ordem crescente dos números indicados no desenho. Ex: 01, 02, 03, 04... até a conclusão da montagem.

**ADVERTENCIA**

Para limpieza de su móvil, use una franela seca o húmeda, y no utilice productos químicos que puedan dañar su producto.

**SISTEMA DE MONTAJE**

El sistema de montaje de los productos funciona de acuerdo con el orden creciente de los números indicados en el dibujo. Ej.: 01, 02, 03, 04... hasta la conclusión del montaje.

**NOTICE**

To clean your furniture, use a dry or wet cloth, and do not use chemicals that may damage your product.



**ASSEMBLY SYSTEM**

The products' assembly system works according to the increasing order of the indicated numbers. For example: 01, 02, 03, 04 ... to the end of the assembly.

**Lista de Peças | Lista de piezas | List of parts**

Item	Caixa Caja Box	Qty Ctd Qty	Descrição   Descripción   Description	Medidas (mm)   Dimensions (mm)   Size (measure- ments) (mm)
01	1/1	01	Tampo   Tapa   Top	800x533x25

**Ferragens | Herrajes | Hardware**

<b>A</b>		08x	<b>B</b>		04x
Parafuso 3,5x14mm FLA. Tornillo 3,5x14mm FLA. Screw 3,5x14mm FLA.			Cantoneira plástica Cantонера plástica Plastic angle brackets		



Estas ferragens constam no Pacote do respectivo Balcão.  
Estos herrajes constan en el Paquete del respectivo Balcón.  
These hardware are included in the Package of the respective Counter.

Esse tampo é opcional e é vendido separadamente

Esta vez es opcional y se vende por separado

This top is optional and is sold separately

Exemplo de como fixar o Tampo Cooktop no produto.

Ejemplo de cómo fijar el Tablero Cooktop en el producto.

Example of how to secure the Cooktop Top to the product.

