

HENNInd. e Com. de Móveis Henn
Mondai - SC - Brasil

☎ +55 49 3674.3500

📱 @moveishenn
www.henn.com.br**INSTRUÇÕES DE
MONTAGEM**INSTRUCCIONES DE MONTAJE
ASSEMBLY INSTRUCTIONS**Aéreo 02 Porta Basculante 1200mm Requite | Aéreo 02
Puerta Abatible 1200mm Requite |
Aerial 02 Tipper Door 1200mm Requite**

C631-128 Nature

C631-217 Nature/Areia HP

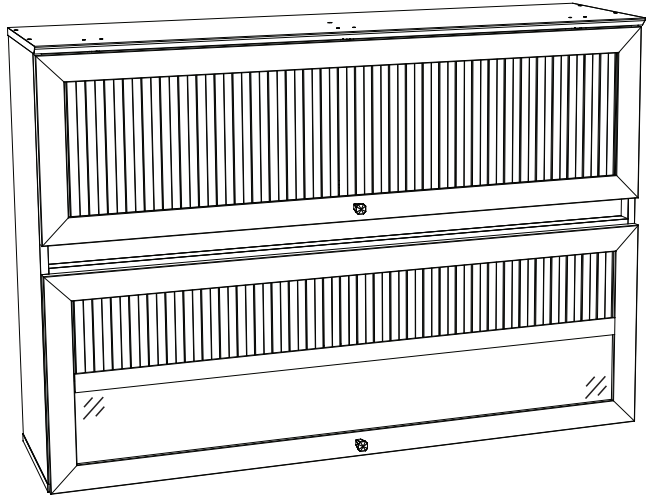
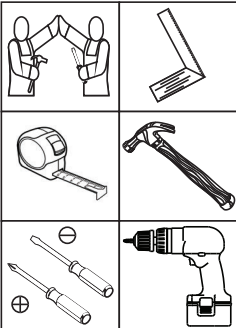
**Requisitos para montagem
Requisitos para la montaje
Assembly Requirements**

Imagens meramente ilustrativas,
não acompanha o produto.
Imágenes ilustrativas, no incluidas
con el producto.
Illustrative images, not included
with the product.

AVISO

Para limpeza de seu móvel, use uma flanela seca ou umedecida, e não utilize produtos químicos que possam danificar seu produto.

SISTEMA DE MONTAGEM

O sistema de montagem dos produtos, funciona de acordo com a ordem crescente dos números indicados no desenho. Ex: 01, 02, 03, 04... até a conclusão da montagem.

ASSISTÊNCIA TÉCNICA

Para solicitação de Assistência Técnica você consumidor deverá entrar em contato com o Lojista o qual você realizou a compra deste produto e solicitar a assistência técnica das peças avariadas. A garantia abrange todas as peças, partes e componentes que eventualmente venham apresentar defeito de fabricação no prazo de 03 (três) meses, contando a partir da entrega do produto ao consumidor, mediante nota fiscal de compra. Se houver qualquer alteração na estrutura do produto ou ocorrer defeito por negligência do montador/consumidor em relação a instrução de montagem e manuseio, não será fornecido assistência técnica gratuita.

ADVERTENCIA

Para limpieza de su móvil, use una flanela seca o húmeda, y no utilice productos químicos que puedan dañar su producto.

SISTEMA DE MONTAJE

El sistema de montaje de los productos funciona de acuerdo con el orden creciente de los números indicados en el dibujo. Ej.: 01, 02, 03, 04... hasta la conclusión del montaje.

ASISTENCIA TÉCNICA

Para solicitar Asistencia Técnica, el consumidor debe comunicarse con el Comercio que usted realizó la compra de este producto y solicita asistencia técnica para las partes dañadas. La garantía cubre todas las partes, piezas y componentes que eventualmente puedan presentar defecto de fabricación en el plazo de 03 (tres) meses, contados a partir de la entrega del producto al consumidor, mediante factura de compra. Si se produce algún cambio en la estructura del producto o se produce un defecto por negligencia del montador/consumidor en relación con las instrucciones de montaje y manipulación, no se prestará asistencia técnica gratuita.

NOTICE

To clean your furniture, use a dry or wet cloth, and do not use chemicals that may damage your product.

ASSEMBLY SYSTEM

The products' assembly system works according to the increasing order of the indicated numbers. For example: 01, 02, 03, 04 ... to the end of the assembly.

TECHNICAL ASSISTANCE

To request Technical Assistance, the consumer must contact the retailer from whom you purchased this product and request technical assistance for the damaged parts. The warranty covers all parts, parts and components that may eventually present a manufacturing defect within a period of 03 (three) months, counting from the delivery of the product to the consumer, by means of a purchase invoice. If there is any change in the structure of the product or defect occurs due to negligence of the assembler/consumer in relation to the assembly and handling instruction, free technical assistance will not be provided.

ACESSÓRIOS | ACCESORIOS | ACCESSORIES

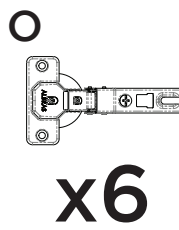
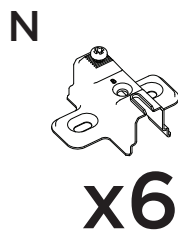
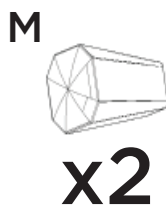
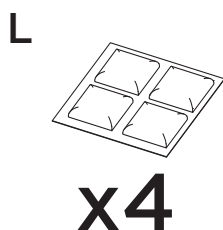
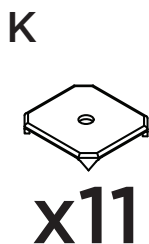
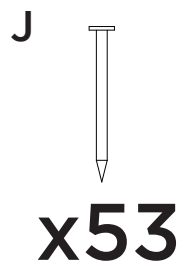
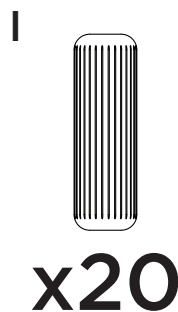
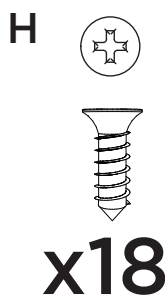
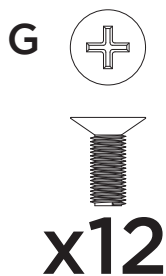
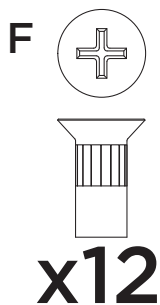
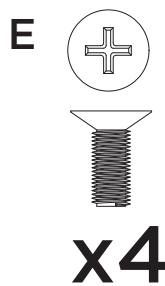
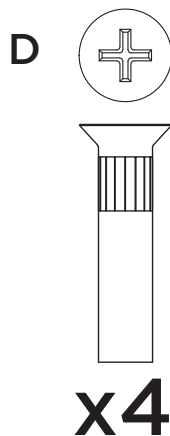
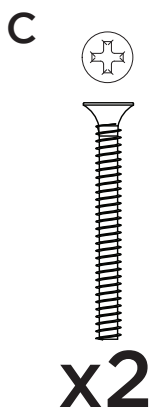
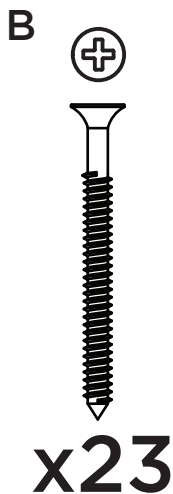
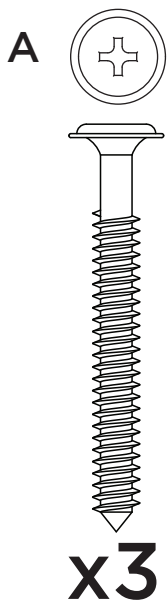

Parafusos em escala
Tornillos escalados
Scaled screws

1:1

ACESSÓRIOS | ACCESORIOS | ACCESSORIES

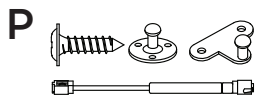

x4 KIT

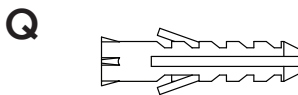

x3

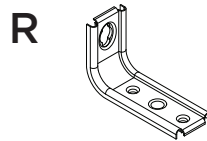

x3

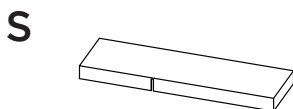

x3

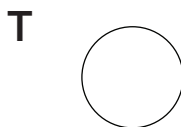

x26

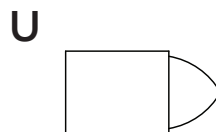

x2

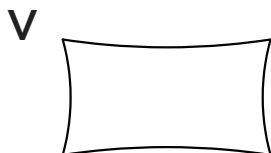

x2



x1



Os parafusos (D/E) devem ser usados somente quando este módulo for acoplado a outro módulo componível Henn.



Los tornillos (D/E) se debe utilizar sólo cuando el módulo está conectado a otro módulo componible Henn.



Screws (D/E) are to be used only when this module is mated to another Henn buildable module.

LISTA DE PEÇAS | LISTA DE PIEZAS | LIST OF PIECES

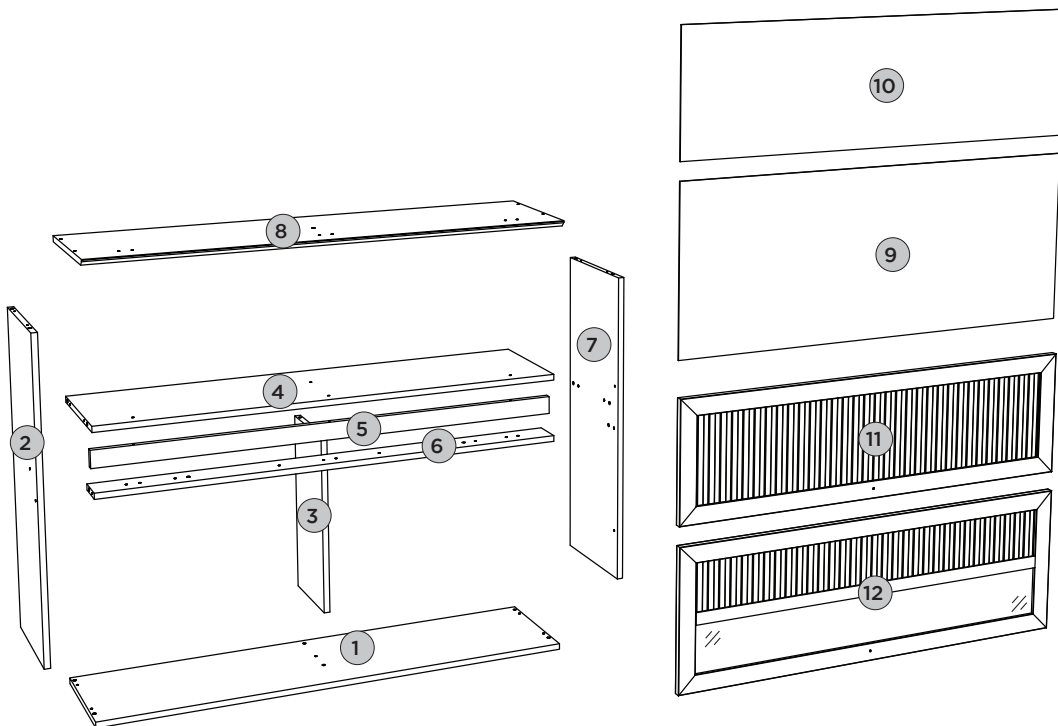

Item	Caixa Caja Box	Qty Ctd Qty	Descrição Descripción Description	Dimensões (mm) Dimensiones (mm)		
				Comprimento Largo Length	Largura Ancho Width	Espessura Grosor Thickness
1	1/1	01	BASE BASE BASE	1200	295	15
2	1/1	01	LATERAL ESQUERDA LATERAL IZQUIERDA LEFT SIDE	800	295	15
3	1/1	01	DIVISÃO DIVISIÓN DIVISION	452	215	15
4	1/1	01	PRATELEIRA ESTANTE SHELF	1168	295	15
5	1/1	01	TRAVESSA FRONTAL TRAVESAÑO FRONTAL FRONT CROSSBAR	1168	45	15
6	1/1	01	TRAVESSA TRAVESAÑO CROSSBAR	1168	80	15
7	1/1	01	LATERAL DIREITA LATERAL DERECHA RIGHT SIDE	800	295	15
8	1/1	01	TAMPO TAPA TOP	1200	322	15
9	1/1	01	FUNDO INFERIOR FONDO INFERIOR LOWER BACKGROUND	1192	471	3
10	1/1	01	FUNDO SUPERIOR FONDO SUPERIOR UPPER BACKGROUND	1192	351	3
11	1/1	01	PORTA MOLDURA RIPADA PUERTA CON MARCO RIPADA STRIPPED FRAME DOOR	1195	345	18
12	1/1	01	PORTA MOLDURA RIPADA DE VIDRO PUERTA CON MARCO VIDRIO RIPADA RIPADA GLASS FRAME DOOR	1195	410	18

PASSO 1

ITM/C631-

PEÇAS REQUERIDAS

2	LATERAL ESQUERDA	x1
3	DIVISÃO	x1
4	PRATELEIRA	x1
5	TRAVESSA FRONTAL	x1
6	TRAVESSA	x1
7	LATERAL DIREITA	x1
8	TAMPO	x1

ACESSÓRIOS REQUERIDOS

F		12
G		12
I		20
N		06
V		

FERRAMENTAS NECESSÁRIAS

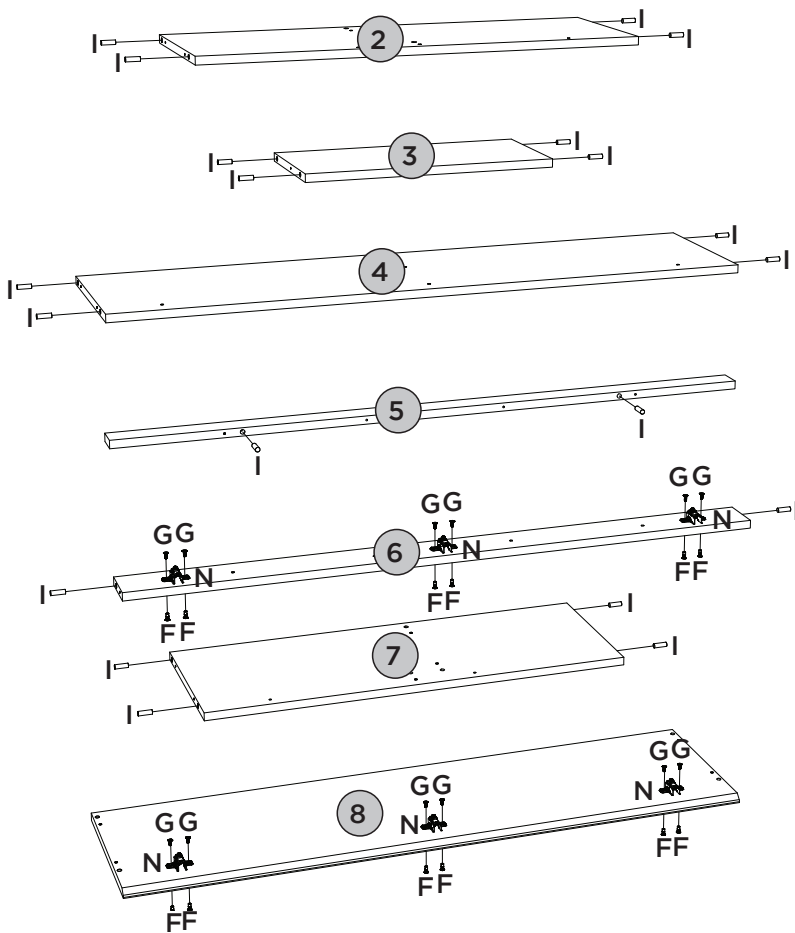
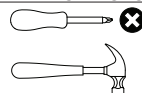

Utilizar o sachê de cola (V) em todas as cavilhas (I) do produto.

Con el pegamento sobre (V) en todos los pernos (I) producto.

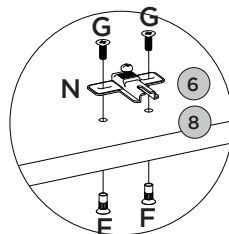

Use the glue sachet (V) on all the pegs (I) of the product.



PEÇAS REQUERIDAS

1	BASE	x1
2	LATERAL ESQUERDA	x1
3	DIVISÃO	x1
4	PRATELEIRA	x1

ACESSÓRIOS REQUERIDOS

B			06
V			

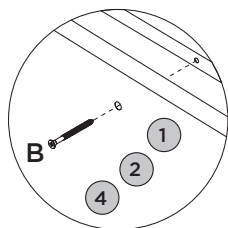
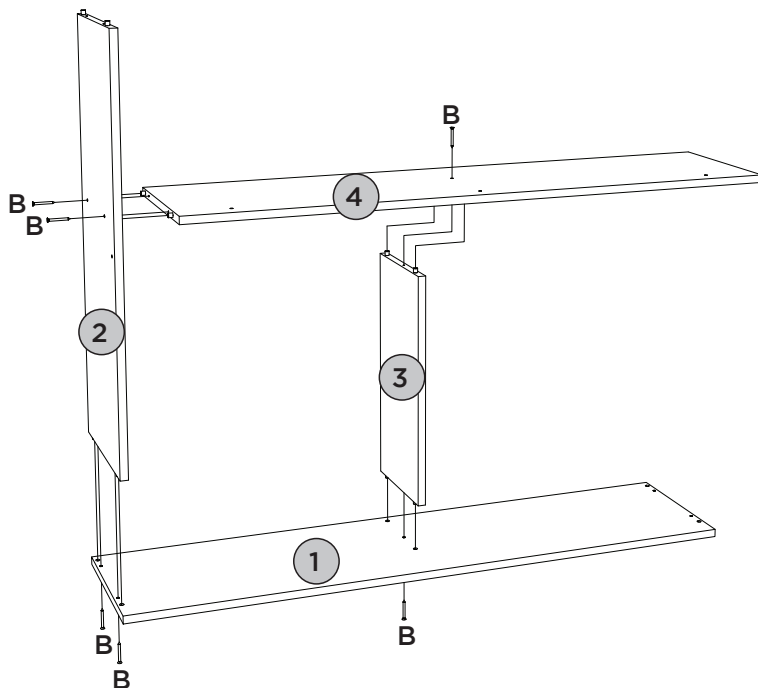
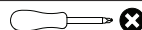

FERRAMENTAS NECESSÁRIAS



PEÇAS REQUERIDAS

5	TRAVESSA FRONTAL	x1
6	TRAVESSA	x1
7	LATERAL DIREITA	x1

ACESSÓRIOS REQUERIDOS

B		10
V		

FERRAMENTAS NECESSÁRIAS

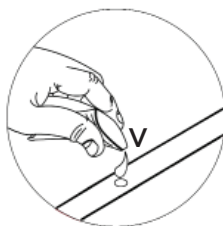
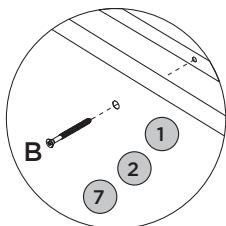
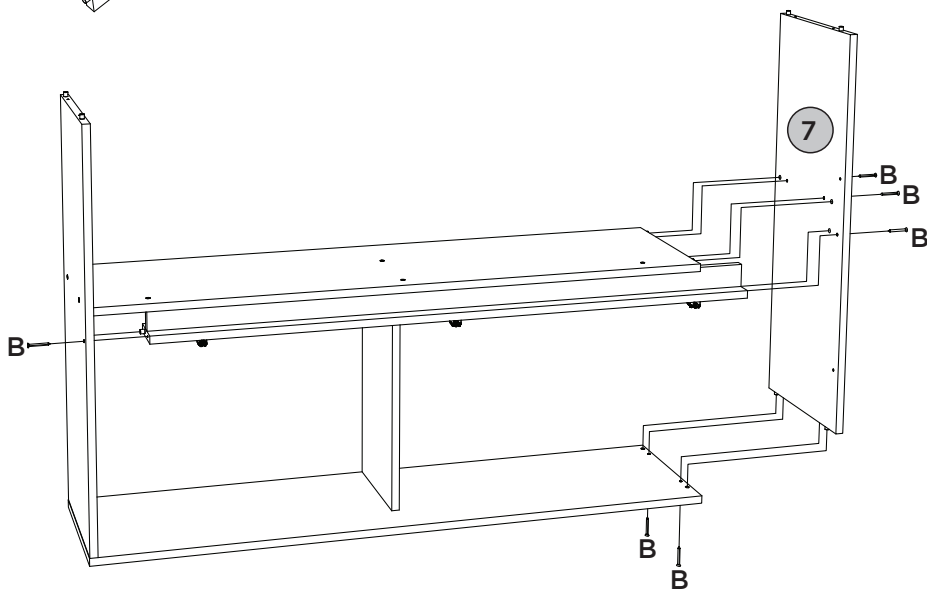
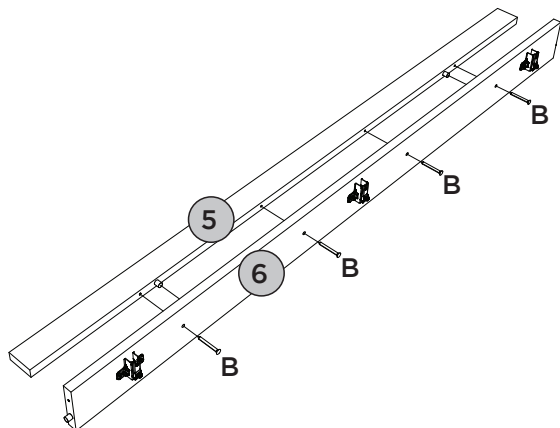



PASSO 4

ITM/C631-

PEÇAS REQUERIDAS

8	TAMPO	x1
---	-------	----

ACESSÓRIOS REQUERIDOS

B		07
V		

FERRAMENTAS NECESSÁRIAS

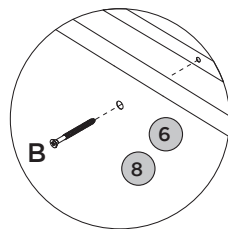
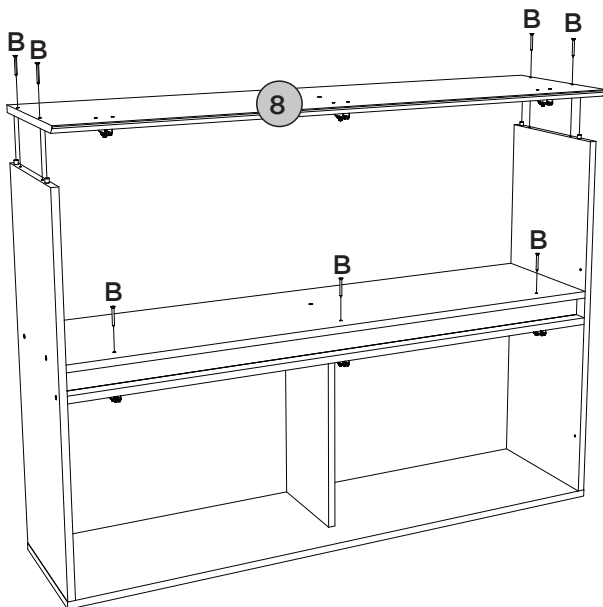
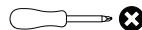



PASSO 5

PEÇAS REQUERIDAS

9	FUNDO INFERIOR	x1
10	FUNDO SUPERIOR	x1

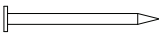
ACESSÓRIOS REQUERIDOS

J		53
K		11

FERRAMENTAS NECESSÁRIAS

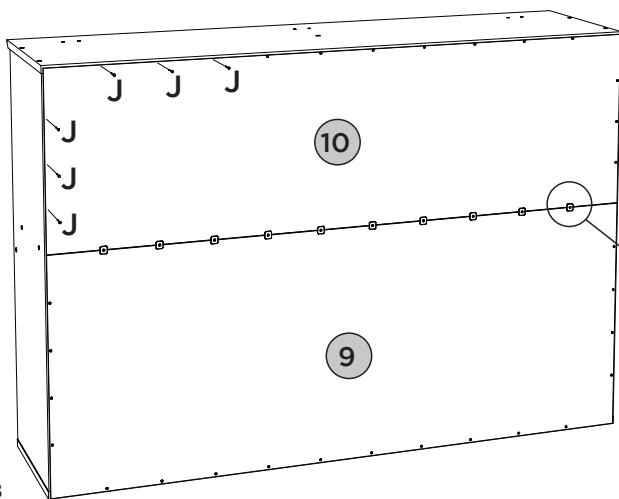

Fixar os pregos a uma distância de 100mm de um para outro.

Fijar las uñas a un distancia de 100mm uno a otro.



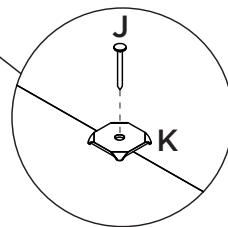

Fix the nails at a distance of 100mm from one to the other



PEÇAS REQUERIDAS

11	PORTA MOLDURA RIPADO	x1
12	PORTA MOLDURA RIPADO DE VIDRO	x1

ACESSÓRIOS REQUERIDOS

C		02
H		12
M		02
O		06

FERRAMENTAS NECESSÁRIAS

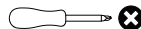

Para portas (11 e 12): Defina para o modo de perfuração.
Faça a furação passante para fixar os puxadores (M).

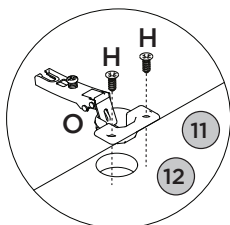
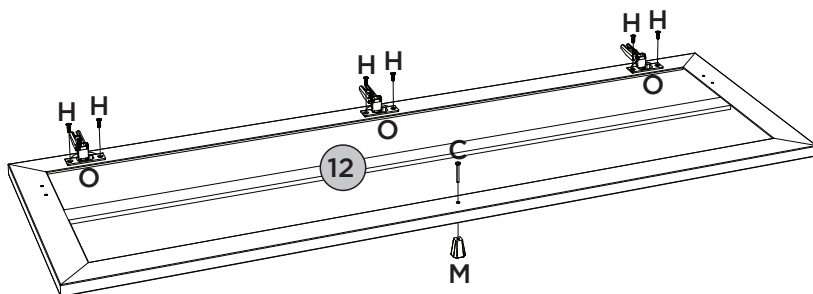
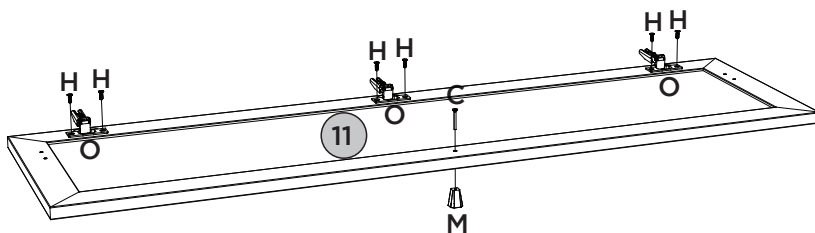

Video: Instalar e regular Dobradiças

Video: Instale y ajuste las bisagras

Video: Install and adjust hinges

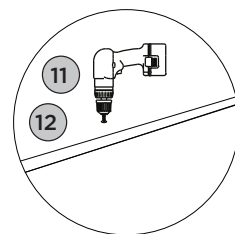

PEÇAS REQUERIDAS

11	PORTA MOLDURA RIPADO	x1
12	PORTA MOLDURA RIPADO DE VIDRO	x1

ACESSÓRIOS REQUERIDOS

L		04
P		04

FERRAMENTAS NECESSÁRIAS

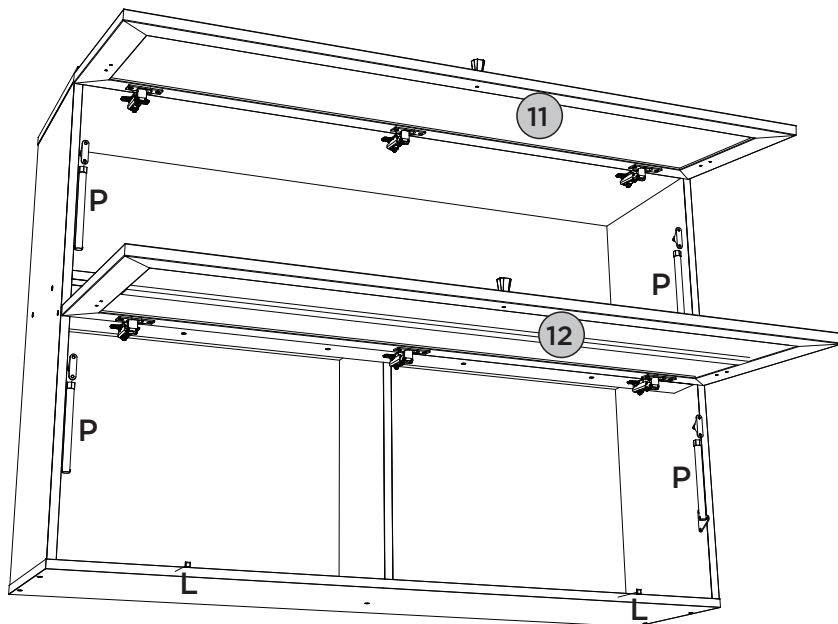
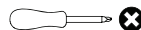

Vídeo: Dicas para instalar o Kit Pistão à Gás

Vídeo: Consejos para instalar el kit de pistón de gas

Vídeo: Tips for installing the Gas Piston Kit

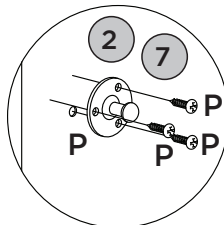
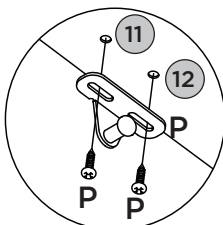
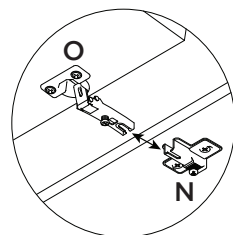
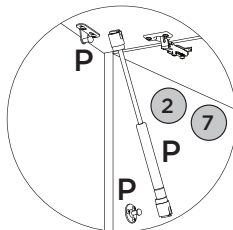

ACESSÓRIOS REQUERIDOS

A		03
H		06
Q		03
R		03
S		03
T		26
U		02
W		01

FERRAMENTAS NECESSÁRIAS



OU
 Para parede: Ajustar no modo perfuração
 Para peça (02, 03 e 07): Usar torque 5

Pesos máximos recomendados com carga distribuída
 Peso máximo recomendado con la carga distribuida
 Recommended maximum weight with distributed load.

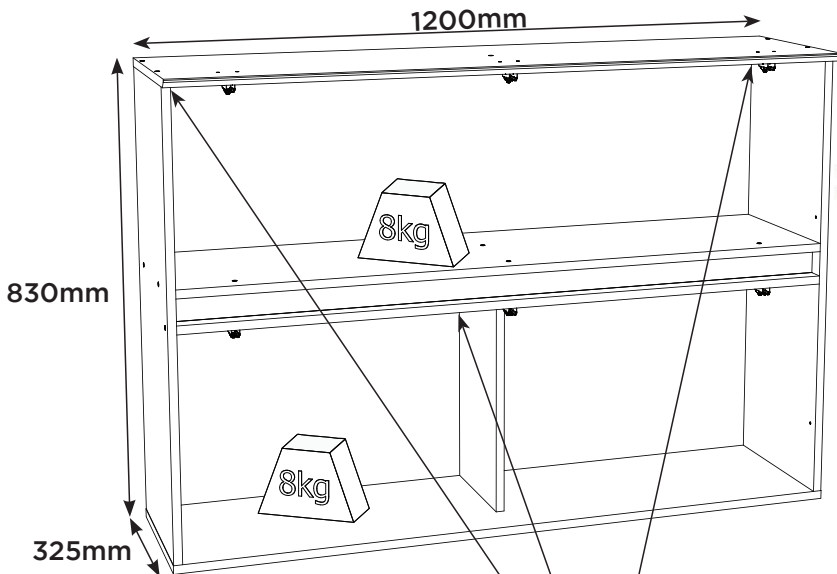

PERFECT CORRECTION
 CORRECCIÓN PERFECTA

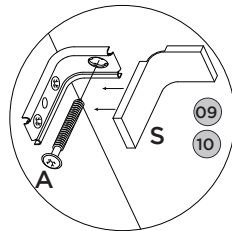
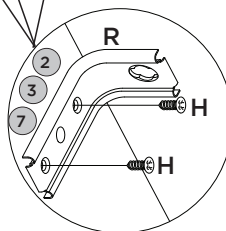
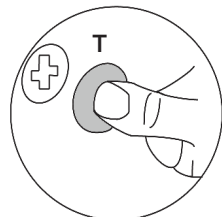
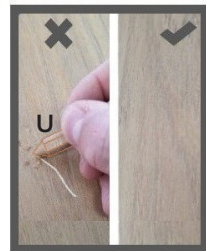

RECOMENDAÇÃO

Para fixar o móvel na parede usar o suporte de fixação (R), o parafuso 4,0x14mm CHT (H), a Bucha 8mm (Q) e o parafuso 5,0x50mm FLA (A).

RECOMENDACIÓN

Para conectar el móvil a la pared con el soporte (R), tornillo 4,0 x14mm CHT (H), el casquillo de 8 mm (Q) y el 5,0 x50mm tornillo FLA (A).

RECOMMENDATION

To fix the furniture to the wall use the fixing bracket (R), the 4,0x14mm CHT screw (H), the 8mm bushing (Q) and the 5.0x50mm FLA screw (A).

Producto Concluído
Producto terminado
Finished Product

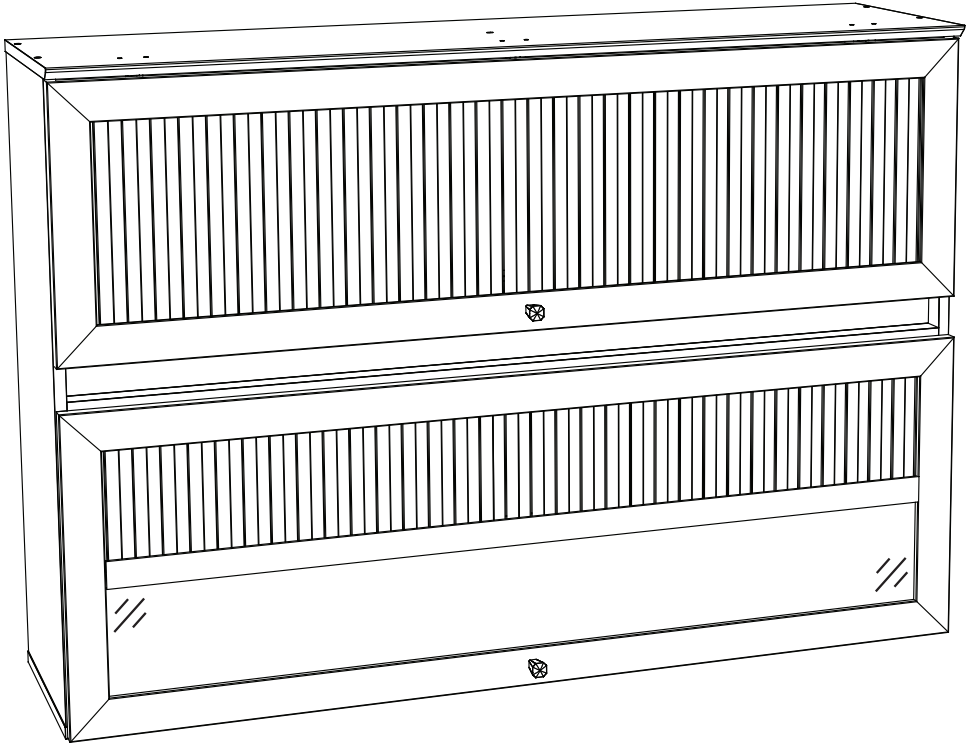

HENNInd. e Com. de Móveis Henn
Mondai - SC - Brasil

☎ +55 49 3674.3500

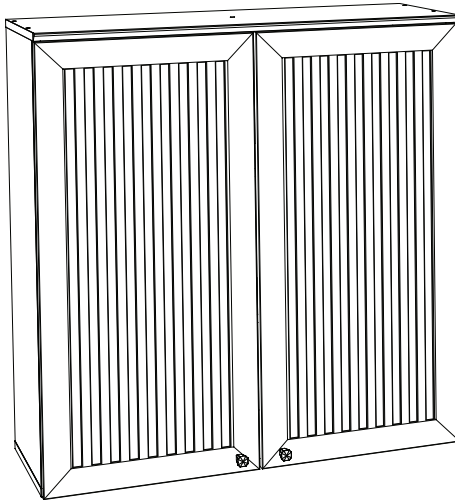
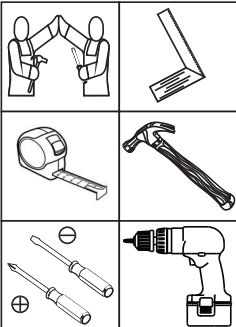
📧 @moveishenn
www.henn.com.br**INSTRUÇÕES DE
MONTAGEM**INSTRUCCIONES DE MONTAJE
ASSEMBLY INSTRUCTIONS**Aéreo 02 Portas 800mm Requite |
Aéreo 02 Puertas 800mm Requite |
Aerial 02 Door 800mm Requite****C632-128 Nature
C632-217 Nature/Areia HP****Requisitos para montagem
Requisitos para la montaje
Assembly Requirements**

Imagens meramente ilustrativas,
não acompanha o produto.
Imágenes ilustrativas, no incluidas
con el producto.
Illustrative images, not included
with the product.

AVISO

Para limpeza de seu móvel, use uma flanela seca ou umedecida, e não utilize produtos químicos que possam danificar seu produto.

SISTEMA DE MONTAGEM

O sistema de montagem dos produtos, funciona de acordo com a ordem crescente dos números indicados no desenho. Ex: 01, 02, 03, 04... até a conclusão da montagem.

ASSISTÊNCIA TÉCNICA

Para solicitação de Assistência Técnica você consumidor deverá entrar em contato com o Lojista o qual você realizou a compra deste produto e solicitar a assistência técnica das peças avariadas. A garantia abrange todas as peças, partes e componentes que eventualmente venham apresentar defeito de fabricação no prazo de 03 (três) meses, contando a partir da entrega do produto ao consumidor, mediante nota fiscal de compra. Se houver qualquer alteração na estrutura do produto ou ocorrer defeito por negligência do montador/consumidor em relação a instrução de montagem e manuseio, não será fornecido assistência técnica gratuita.

ADVERTENCIA

Para limpieza de su móvil, use una flanela seca o húmeda, y no utilice productos químicos que puedan dañar su producto.

SISTEMA DE MONTAJE

El sistema de montaje de los productos funciona de acuerdo con el orden creciente de los números indicados en el dibujo. Ej.: 01, 02, 03, 04... hasta la conclusión del montaje.

ASSISTENCIA TÉCNICA

Para solicitar Asistencia Técnica, el consumidor debe comunicarse con el Comercio que usted realizó la compra de este producto y solicita asistencia técnica para las partes dañadas. La garantía cubre todas las partes, piezas y componentes que eventualmente puedan presentar defecto de fabricación en el plazo de 03 (tres) meses, contados a partir de la entrega del producto al consumidor, mediante factura de compra. Si se produce algún cambio en la estructura del producto o se produce un defecto por negligencia del montador/consumidor en relación con las instrucciones de montaje y manipulación, no se prestará asistencia técnica gratuita.

NOTICE

To clean your furniture, use a dry or wet cloth, and do not use chemicals that may damage your product.

ASSEMBLY SYSTEM

The products' assembly system works according to the increasing order of the indicated numbers. For example: 01, 02, 03, 04 ... to the end of the assembly.

TECHNICAL ASSISTANCE

To request Technical Assistance, the consumer must contact the retailer from whom you purchased this product and request technical assistance for the damaged parts. The warranty covers all parts, parts and components that may eventually present a manufacturing defect within a period of 03 (three) months, counting from the delivery of the product to the consumer, by means of a purchase invoice. If there is any change in the structure of the product or defect occurs due to negligence of the assembler/consumer in relation to the assembly and handling instruction, free technical assistance will not be provided.

ACESSÓRIOS | ACCESORIOS | ACCESSORIES

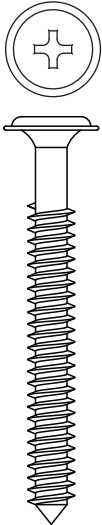
A  **x2**

B  **x12**

C  **x2**

D  **x4**

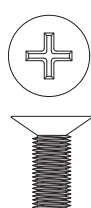
E  **x4**

F  **x28**

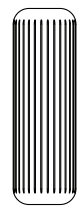
G  **x16**

H  **x48**

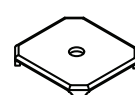
I  **x14**

J  **x2**

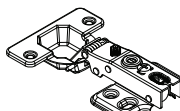
K  **x4**

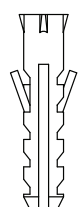
L  **x2**

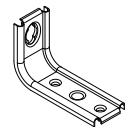
M  **x2**

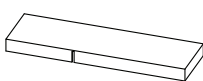
N  **x2**

O  **x14**

P  **x2**

Q  **x1**

R

HENN

x1

Parafusos em escala
Tornillos escalados
Scaled screws **1:1**

 Os parafusos (D/E) devem ser usados somente quando este módulo for acoplado a outro módulo componível Henn.

 Los tornillos (D/E) se debe utilizar sólo cuando el módulo está conectado a otro módulo componible Henn.

 Screws (D/E) are to be used only when this module is mated to another Henn buildable module.

LISTA DE PEÇAS | LISTA DE PIEZAS | LIST OF PIECES

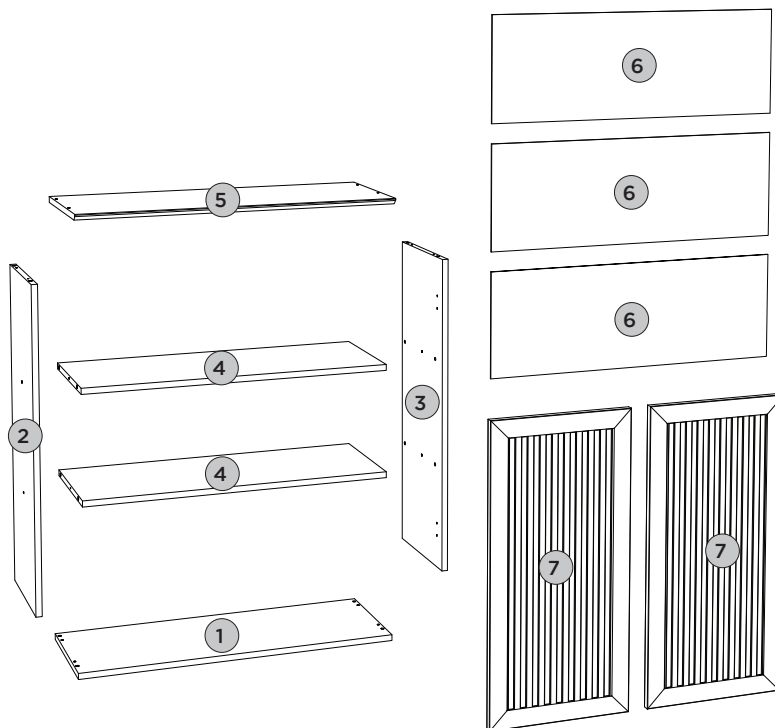

Item	Caixa Caja Box	Qty Ctd Qty	Descrição Descripción Description	Dimensões (mm) Dimensiones (mm)		
				Comprimento Largo Length	Largura Ancho Width	Espessura Grosor Thickness
1	1/1	01	BASE BASE BASE	800	295	15
2	1/1	01	LATERAL ESQUERDA LATERAL IZQUIERDA LEFT SIDE	800	295	15
3	1/1	01	LATERAL DIREITA LATERAL DERECHA RIGHT SIDE	800	295	15
4	1/1	02	PRATELEIRA ESTANTE SHELF	769	295	15
5	1/1	01	TAMPO TAPA TOP	800	322	15
6	1/1	03	FUNDO FONDO BACKGROUND	792	274	3
7	1/1	02	PORTA MOLDURA RIPADA PUERTA CON MARCO RIPADA STRIPPED FRAME DOOR	813	396	18



PASSO 1

ITM/C632-

PEÇAS REQUERIDAS

2	LATERAL ESQUERDA	x1
3	LATERAL DIREITA	x1
4	PRATELEIRA	x2

ACESSÓRIOS REQUERIDOS

G		16
Q		

FERRAMENTAS NECESSÁRIAS

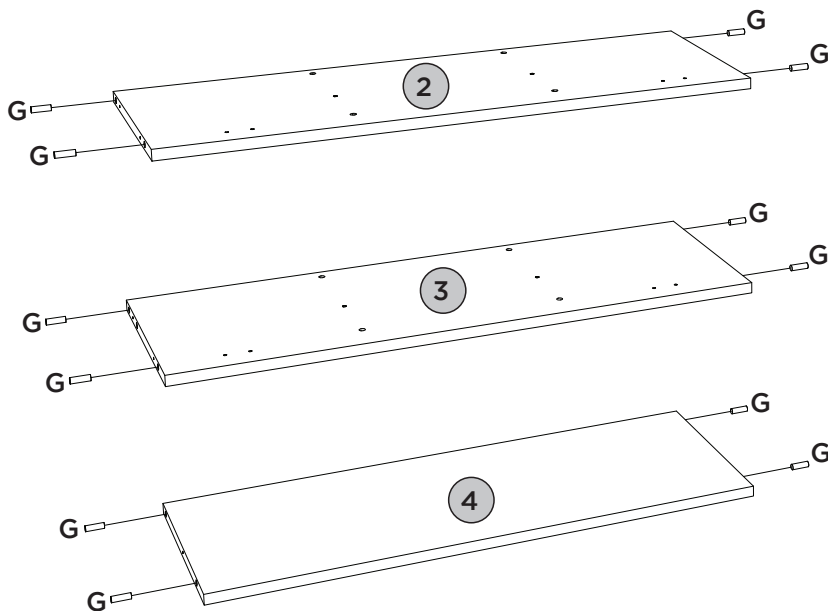
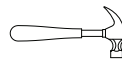

Utilizar o sachê de cola (Q) em todas as cavilhas (G) do produto.

Con el pegamento sobre (Q) en todos los pernos (G) producto.

Use the glue sachet (Q) on all the pegs (G) of the product.



PASSO 2

ITM/C632-

PEÇAS REQUERIDAS

1	BASE	x1
2	LATERAL ESQUERDA	x1
3	LATERAL DIREITA	x1
4	PRATELEIRA	x2
5	TAMPO	x1

ACESSÓRIOS REQUERIDOS

B		12
Q		

FERRAMENTAS NECESSÁRIAS

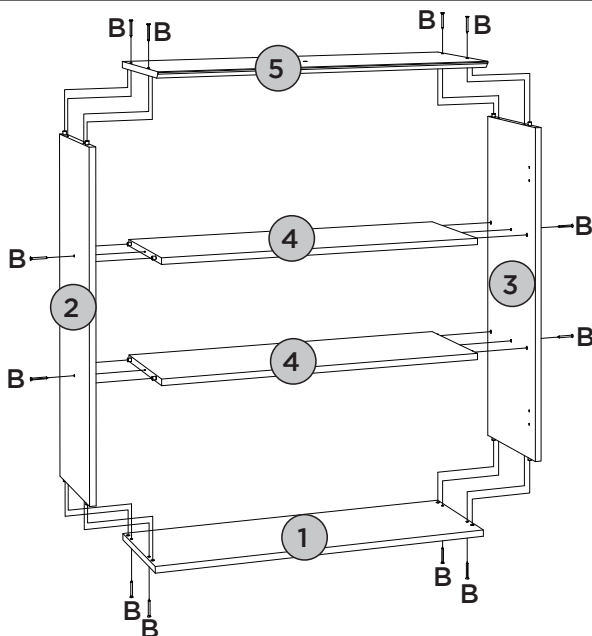
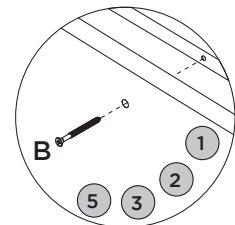
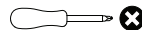



PASSO 3

PEÇAS REQUERIDAS

6	FUNDO	x3
---	-------	----

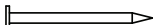
ACESSÓRIOS REQUERIDOS

H		48
I		14

FERRAMENTAS NECESSÁRIAS

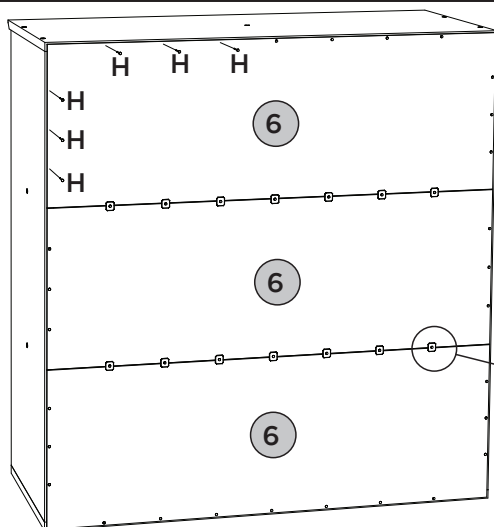
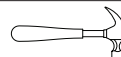

Fixar os pregos a uma distância de 100mm de um para outro.

Fijar las uñas a un distancia de 100mm uno a otro.

Fix the nails at a distance of 100mm from one to the other

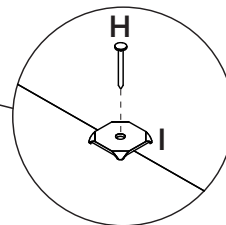



PASSO 4

ITM/C632-

PEÇAS REQUERIDAS

7	PORTA	x2
---	-------	----

ACESSÓRIOS REQUERIDOS

F		08
K		04

FERRAMENTAS NECESSÁRIAS

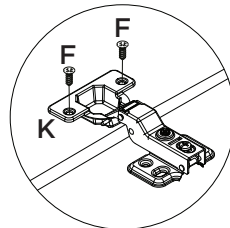
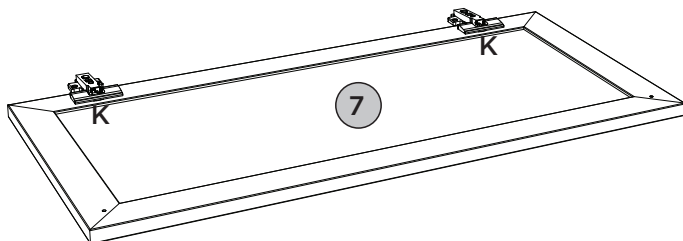
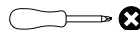



PASSO 5

PEÇAS REQUERIDAS

7	PORTA	x2
---	-------	----

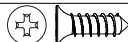
ACESSÓRIOS REQUERIDOS

C		02
F		16
J		02

FERRAMENTAS NECESSÁRIAS

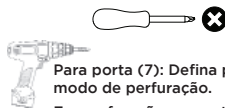

Para porta (7): Defina para o modo de perfuração.

Faça a furação passante para fixar os puxadores (J).

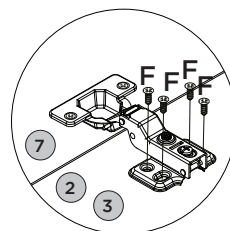
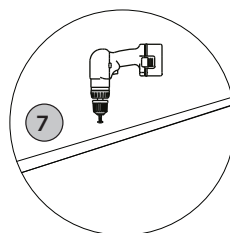
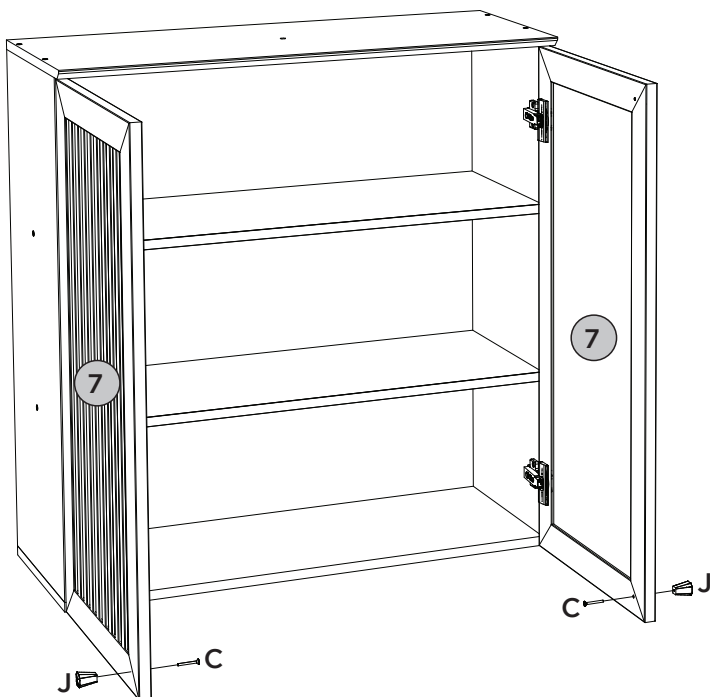

ACESSÓRIOS REQUERIDOS

A		02
F		04
L		02
M		02
N		02
O		14
P		02
R		01

FERRAMENTAS NECESSÁRIAS



OU

Para parede: Ajustar no modo perfuração
Para peça (02 e 03): Usar torque 5

Pesos máximos recomendados com carga distribuída
Peso máximo recomendado con la carga distribuida
Recommended maximum weight with distributed load.

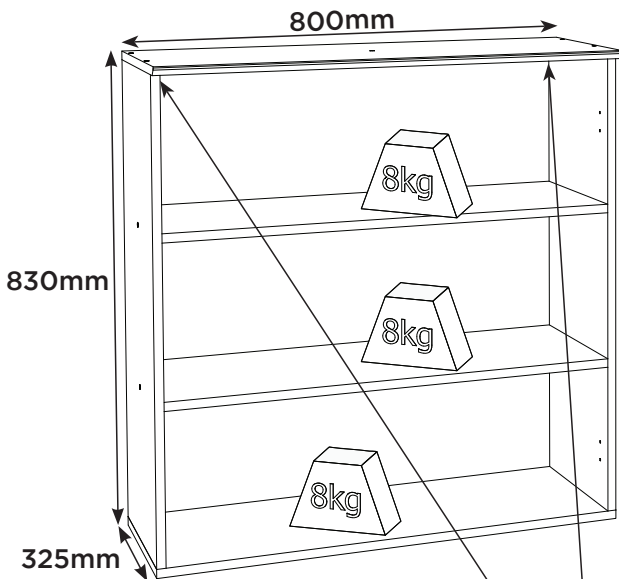

PERFECT CORRECTION
CORRECCIÓN PERFECTA

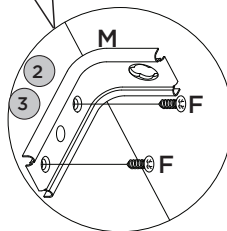
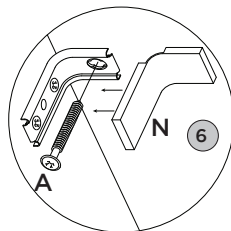
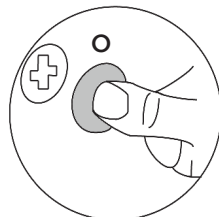
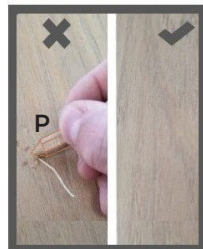

RECOMENDAÇÃO

Para fixar o móvel na parede usar o suporte de fixação (M), o parafuso 4,0x14mm CHT (F), a Bucha 8mm (L) e o parafuso 5,0x50mm FLA (A).

RECOMENDACIÓN

Para conectar el móvil a la pared con el soporte (M), tornillo 4,0 x14mm CHT (F), el casquillo de 8 mm (L) y el 5,0 x50mm tornillo FLA (A).

RECOMMENDATION

To fix the furniture to the wall use the fixing bracket (M), the 4,0x14mm CHT (F) screw, the 8mm bushing (L) and the 5,0x50mm FLA screw (A).

Produto Concluído
Producto terminado
Finished Product

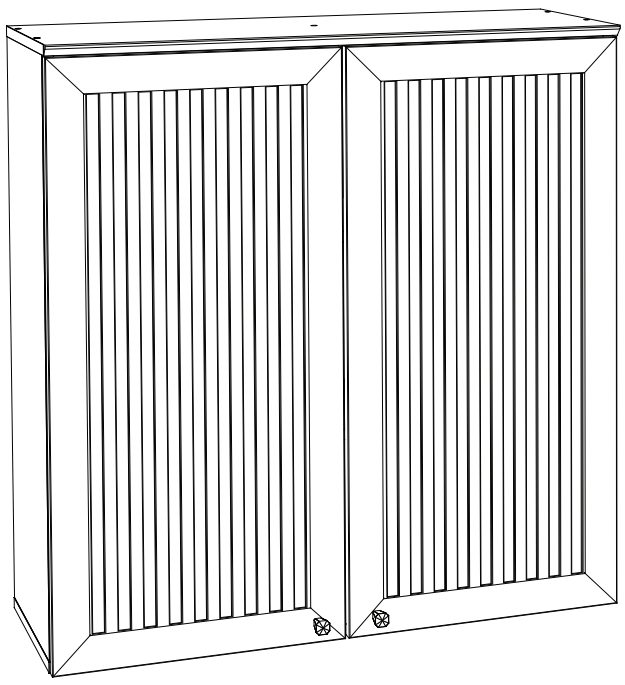

HENNInd. e Com. de Móveis Henn
Mondai - SC - Brasil

☎ +55 49 3674.3500

📧 @moveishenn
www.henn.com.br**INSTRUÇÕES DE
MONTAGEM**INSTRUCCIONES DE MONTAJE
ASSEMBLY INSTRUCTIONS**Aéreo Canto Reto 01 Porta Requite |
Aire Esquina Recto 01 Puerta Requite |
Aerial Corner Challenge 01 Door Requite**

C634-128 Nature

C634-217 Nature/Areia HP

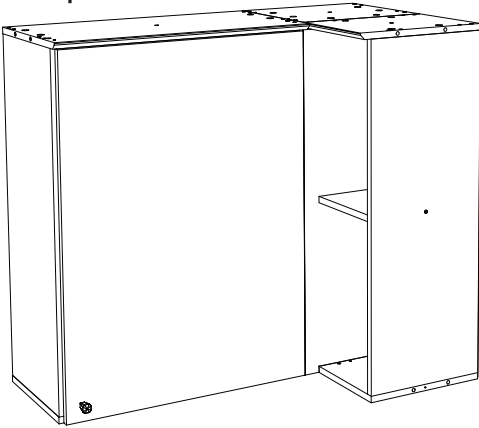
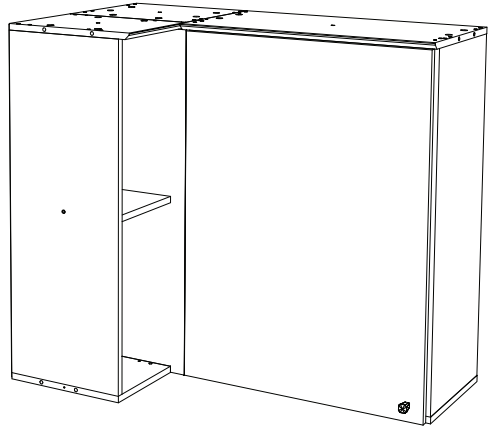
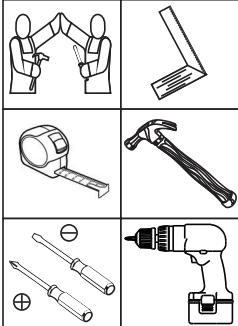
**Opção 1
Opción 1
Option 1****Opção 2
Opción 2
Option 2****Requisitos para montagem
Requisitos para la montaje
Assembly Requirements****Imagens meramente ilustrativas,
não acompanha o produto.
Imágenes ilustrativas, no incluidas
con el producto.
Illustrative images, not included
with the product.****AVISO**

Para limpeza de seu móvel, use uma flanela seca ou umedecida, e não utilize produtos químicos que possam danificar seu produto.

SISTEMA DE MONTAGEM

O sistema de montagem dos produtos, funciona de acordo com a ordem crescente dos números indicados no desenho. Ex: 01, 02, 03, 04... até a conclusão da montagem.

ASSISTÊNCIA TÉCNICA

Para solicitação de Assistência Técnica você consumidor deverá entrar em contato com o Lojista o qual você realizou a compra deste produto e solicitar a assistência técnica das peças avariadas. A garantia abrange todas as peças, partes e componentes que eventualmente venham apresentar defeito de fabricação no prazo de 03 (três) meses, contando a partir da entrega do produto ao consumidor, mediante nota fiscal de compra. Se houver qualquer alteração na estrutura do produto ou ocorrer defeito por negligência do montador/consumidor em relação a instrução de montagem e manuseio, não será fornecido assistência técnica gratuita.

ADVERTENCIA

Para limpieza de su móvil, use una flanela seca o húmeda, y no utilice productos químicos que puedan dañar su producto.

SISTEMA DE MONTAJE

El sistema de montaje de los productos funciona de acuerdo con el orden creciente de los números indicados en el dibujo. Ej.: 01, 02, 03, 04... hasta la conclusión del montaje.

ASISTENCIA TÉCNICA

Para solicitar Asistencia Técnica, el consumidor debe comunicarse con el Comercio que usted realizó la compra de este producto y solicita asistencia técnica para las partes dañadas. La garantía cubre todas las partes, piezas y componentes que eventualmente puedan presentar defecto de fabricación en el plazo de 03 (tres) meses, contados a partir de la entrega del producto al consumidor, mediante factura de compra. Si se produce algún cambio en la estructura del producto o se produce un defecto por negligencia del montador/consumidor en relación con las instrucciones de montaje y manipulación, no se prestará asistencia técnica gratuita.

NOTICE

To clean your furniture, use a dry or wet cloth, and do not use chemicals that may damage your product.

ASSEMBLY SYSTEM

The products' assembly system works according to the increasing order of the indicated numbers. For example: 01, 02, 03, 04 ... to the end of the assembly.

TECHNICAL ASSISTANCE

To request Technical Assistance, the consumer must contact the retailer from whom you purchased this product and request technical assistance for the damaged parts. The warranty covers all parts, parts and components that may eventually present a manufacturing defect within a period of 03 (three) months, counting from the delivery of the product to the consumer, by means of a purchase invoice. If there is any change in the structure of the product or defect occurs due to negligence of the assembler/consumer in relation to the assembly and handling instruction, free technical assistance will not be provided.

ACESSÓRIOS | ACCESORIOS | ACCESSORIES

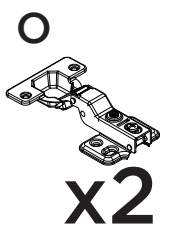
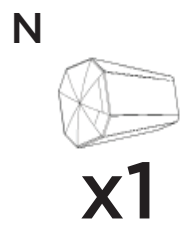
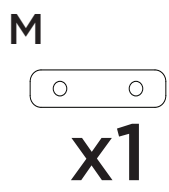
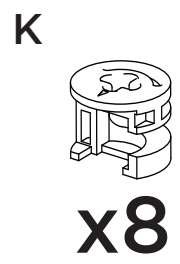
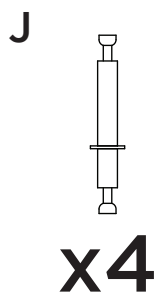
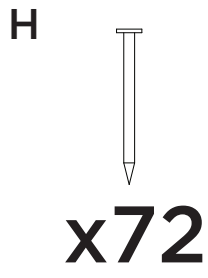
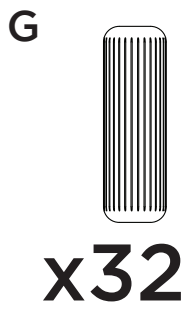
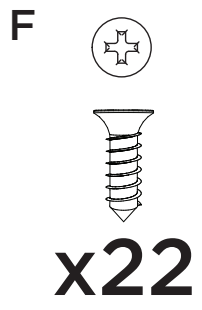
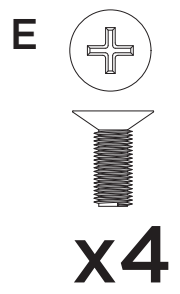
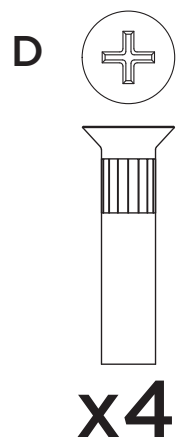
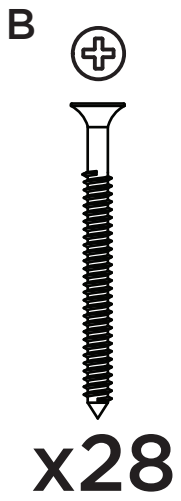
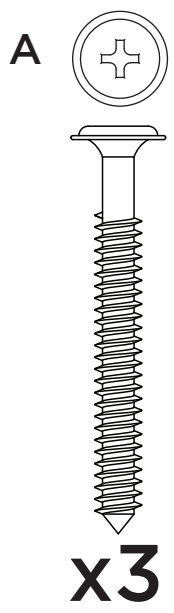

Parafusos em escala
Tornillos escalados
Scaled screws **1:1**

ACESSÓRIOS | ACCESORIOS | ACCESSORIES

P

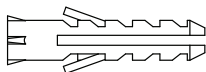

x3

Q

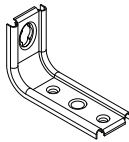

x3

R

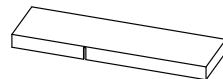

x3

S

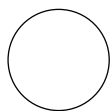

x30

T

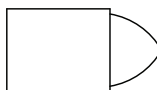

x2

U

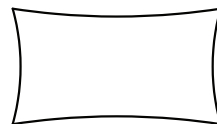

x2



Os parafusos (D/E) devem ser usados somente quando este módulo for acoplado a outro módulo componível Henn.



Los tornillos (D/E) se debe utilizar sólo cuando el módulo está conectado a otro módulo componible Henn.



Screws (D/E) are to be used only when this module is mated to another Henn buildable module.

LISTA DE PEÇAS | LISTA DE PIEZAS | LIST OF PIECES

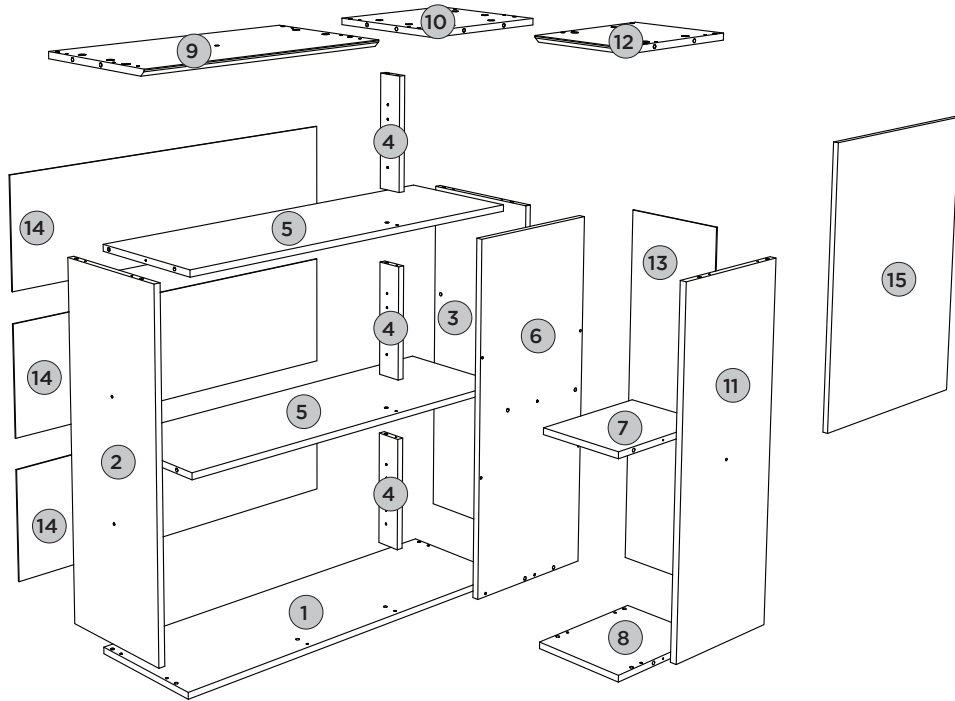

Item	Caixa Caja Box	Qty Ctd Qty	Descrição Descripción Description	Dimensões (mm) Dimensions (mm) Dimensions (mm)		
				Comprimento Largo Length	Largura Ancho Width	Espessura Grosor Thickness
1	1/1	01	BASE BASE BASE	940	295	15
2	1/1	01	LATERAL ESQUERDA LATERAL IZQUIERDA LEFT SIDE	800	295	15
3	1/1	01	FUNDO 15MM FONDO 15MM 15MM BOTTOM	800	295	15
4	1/1	03	PILASTRA DA PORTA PUERTA PILASTRA DOOR PILASTER	256	60	15
5	1/1	02	PRATELEIRA ESTANTE SHELF	909	295	15
6	1/1	01	FRENTE FIXA FRENTE FIJA FIXED FRONT	815	333	15
7	1/1	01	PRATELEIRA NICHU ESTANTERIA DE NICHU NICHE SHELF	293	208	15
8	1/1	01	BASE NICHU NICHU BASE BASE NICHE	295	223	15
9	1/1	01	TAMPO MAIOR TAPA MAYOR TOP SURFACE	618	322	15
10	1/1	01	TAMPO MENOR TAPA MAYOR TOP SURFACE	322	295	15
11	1/1	01	LATERAL DIREITA NICHU NICHU LADO DERECHO RIGHT SIDE NICHE	800	295	15
12	1/1	01	TAMPO NICHU TAPA NICHU NICHE TOP	322	238	15
13	1/1	01	FUNDO MENOR FONDO MENOR MINOR FUND	824	235	3
14	1/1	03	FUNDO FONDO BOTTOM	933	273	3
15	1/1	01	PORTA PUERTA DOOR	813	597	15



PASSO 1

ITM/C634-

PEÇAS REQUERIDAS

2	LATERAL ESQUERDA	x1
3	FUNDO 15MM	x1
4	PILASTRA DA PORTA	x3

ACESSÓRIOS REQUERIDOS

G		14
U		

FERRAMENTAS NECESSÁRIAS

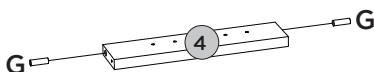
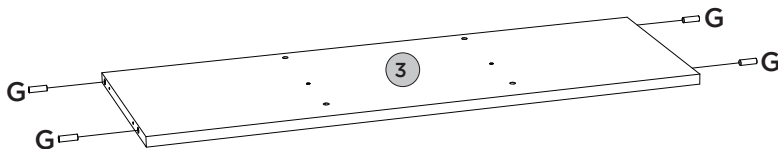
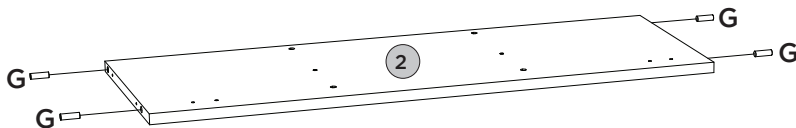
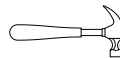

Utilizar o sachê de cola (U) em todas as cavilhas (G) do produto.

Con el pegamento sobre (U) en todos los pernos (G) producto.

Use the glue sachet (U) on all the pegs (G) of the product.



PASSO 2

ITM/C634-

PEÇAS REQUERIDAS

5	PRATELEIRA	x2
7	PRATELEIRA NICHU	x1
11	LATERAL DIREITA NICHU	x1

ACESSÓRIOS REQUERIDOS

G		16
U		

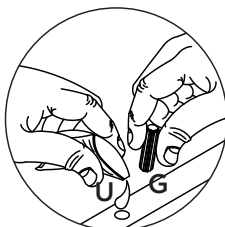
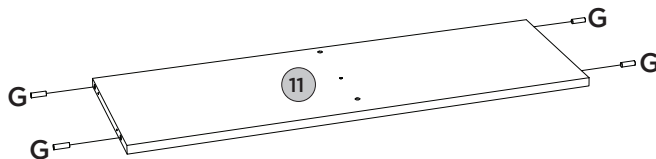
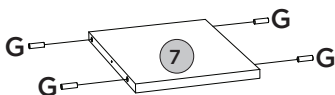
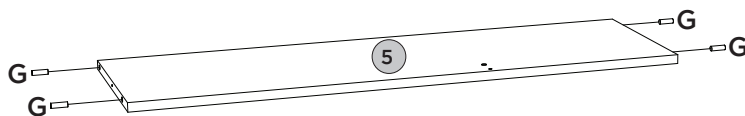
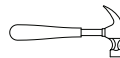

FERRAMENTAS NECESSÁRIAS



PEÇAS REQUERIDAS

1	BASE	x1
2	LATERAL ESQUERDA	x1
3	FUNDO 15MM	x1
4	PILASTRA DA PORTA	x3
5	PRATELEIRA	x2

ACESSÓRIOS REQUERIDOS

B		11
U		

FERRAMENTAS NECESSÁRIAS

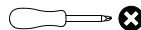

Opção 1 Opción 1 Option 1

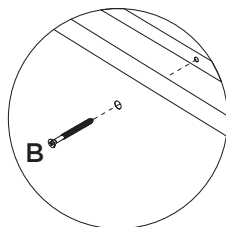
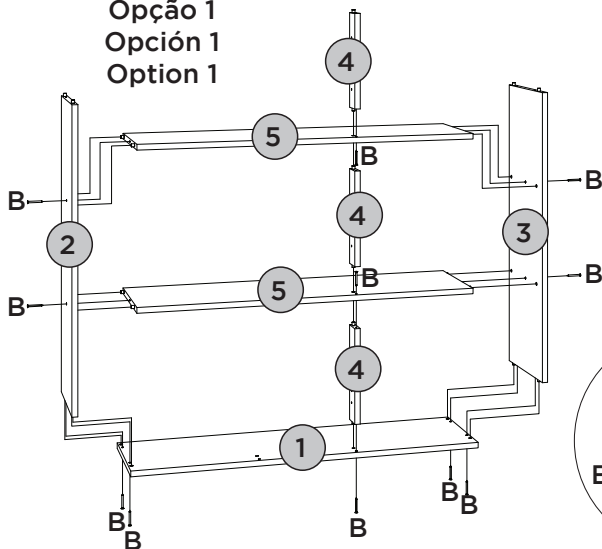

Opção 2 Opción 2 Option 2

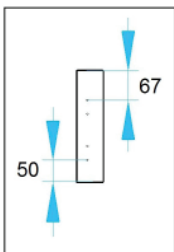
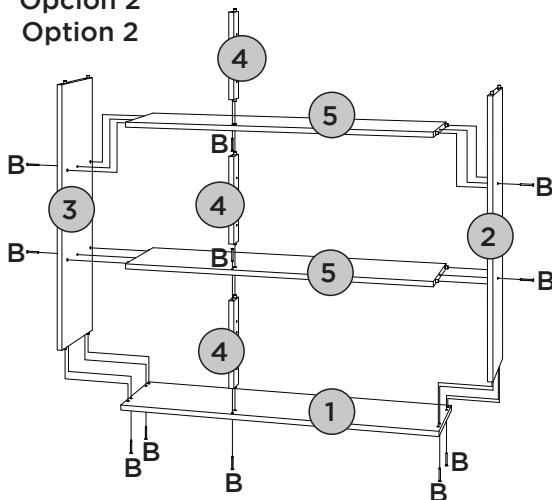

Peça (04) com o lado da pinção de 50mm para baixo.

Parte (04) con el lado del orificio de 50mm hacia abajo.

Part (04) with the side of the pinhole of 50mm down.



PASSO 4

ITM/C634-

PEÇAS REQUERIDAS

6	FRENTE FIXA	x1
7	PRATELEIRA NICHO	x1
8	BASE NICHO	x1

ACESSÓRIOS REQUERIDOS

B		02
G		02
U		

FERRAMENTAS NECESSÁRIAS

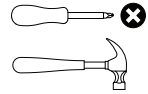

Opção 1 Opción 1 Option 1

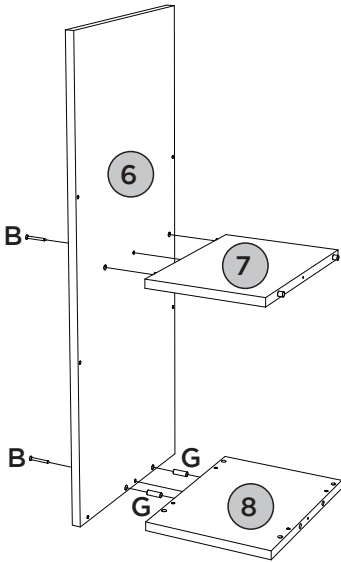

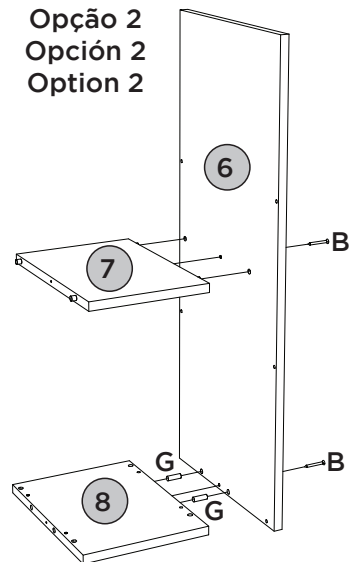

Opção 2 Opción 2 Option 2



PEÇAS REQUERIDAS

9	TAMPO MAIOR	x1
10	TAMPO	x1

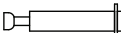
ACESSÓRIOS REQUERIDOS

J		02
K		04

FERRAMENTAS NECESSÁRIAS

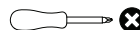



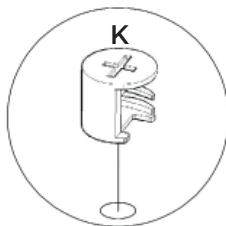
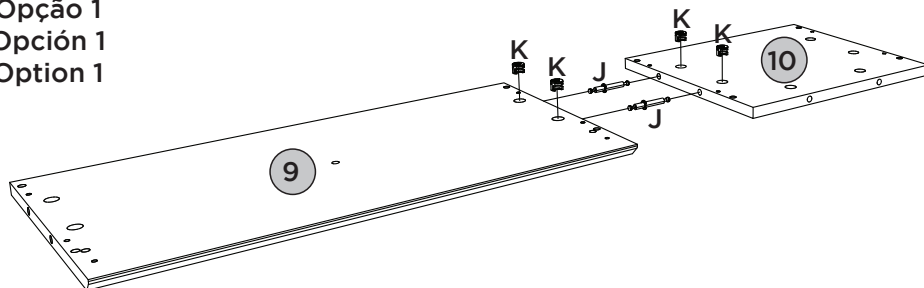

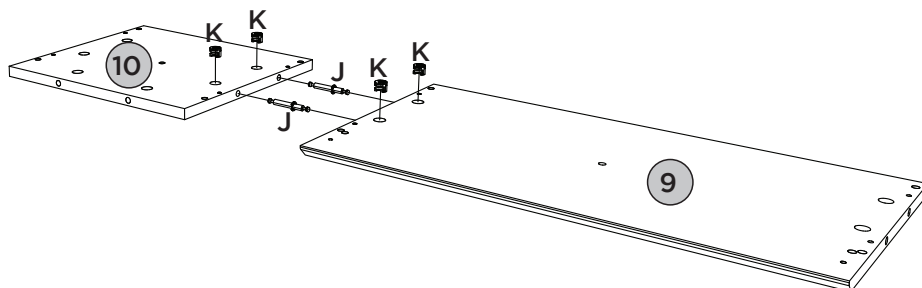

Opção 1
Opción 1
Option 1



Opção 2
Opción 2
Option 2

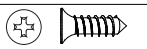

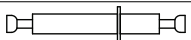
ACESSÓRIOS REQUERIDOS
FERRAMENTAS NECESSÁRIAS

B		10	K		02
F		02	L		01
J		02	U		

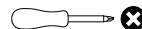
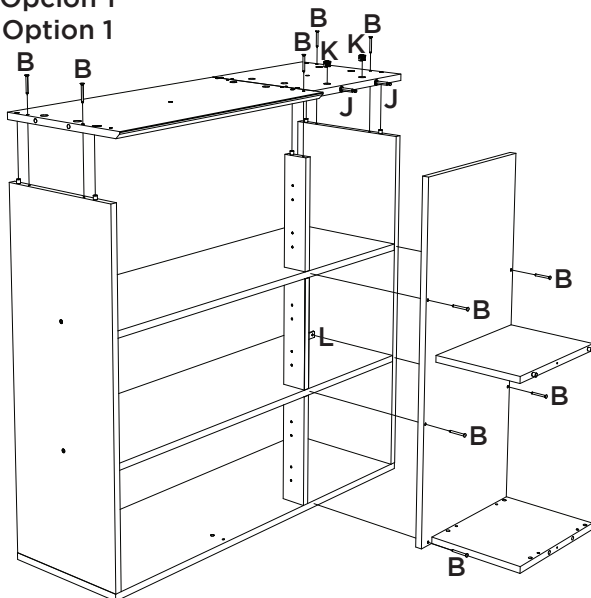
Opção 1
Opcción 1
Option 1

Na opção do Nicho, recomenda-se apertar as ferragens J e K antes de fixar a peça 06.

En la opción de nicho, se recomienda para apretar los accesorios J y K antes de fijar la pieza 06.

In the Niche, it is recommended to tighten the hardware J and K before securing part 06.

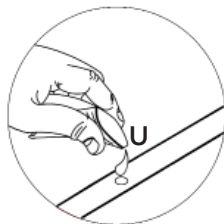
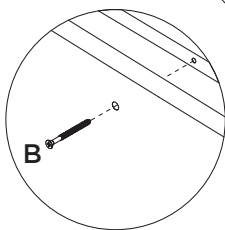
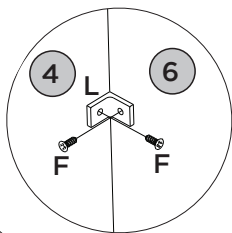
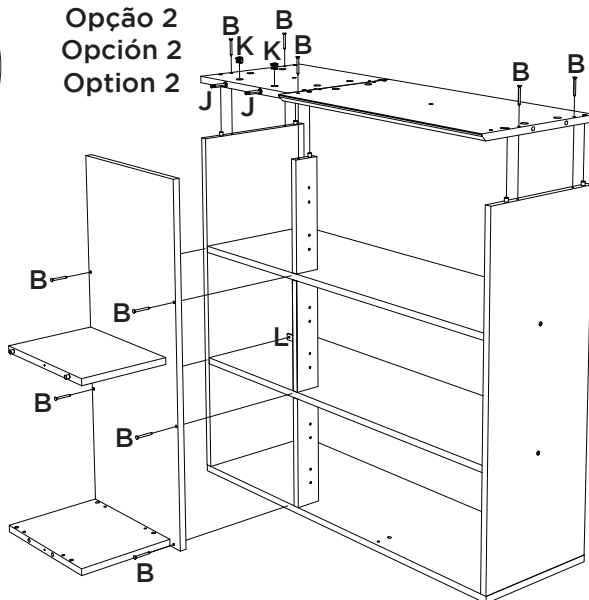
Opção 2
Opcción 2
Option 2





PASSO 7

ITM/C634-

PEÇAS REQUERIDAS

11	LATERAL DIREITA NICHOS	x1
12	TAMPO NICHOS	x1

ACESSÓRIOS REQUERIDOS

B		05
K		02
U		

FERRAMENTAS NECESSÁRIAS

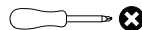

Opção 1
Opción 1
Option 1

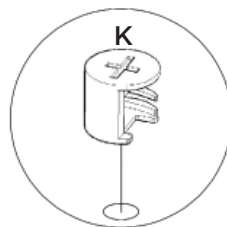
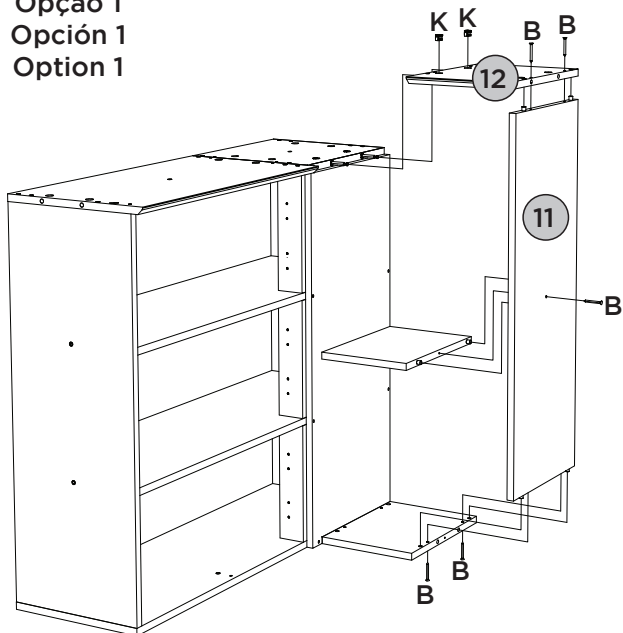

Opção 2
Opción 2
Option 2

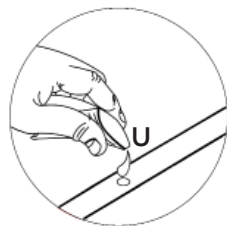
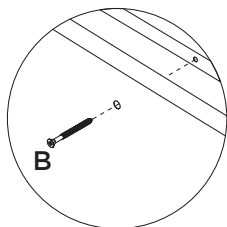
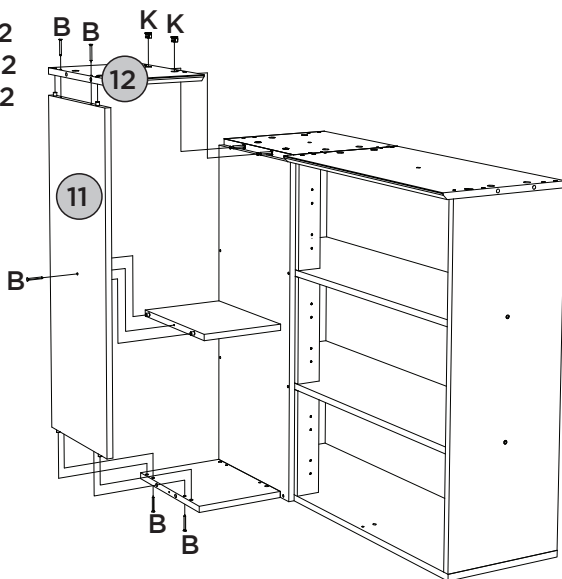



PASSO 8

ITM/C634-

PEÇAS REQUERIDAS

13	FUNDO MENOR	x1
14	FUNDO	x3

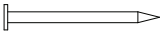
ACESSÓRIOS REQUERIDOS

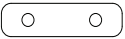
F		02
H		72
I		16
M		01

FERRAMENTAS NECESSÁRIAS

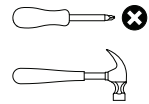

Opção 1
Opción 1
Option 1

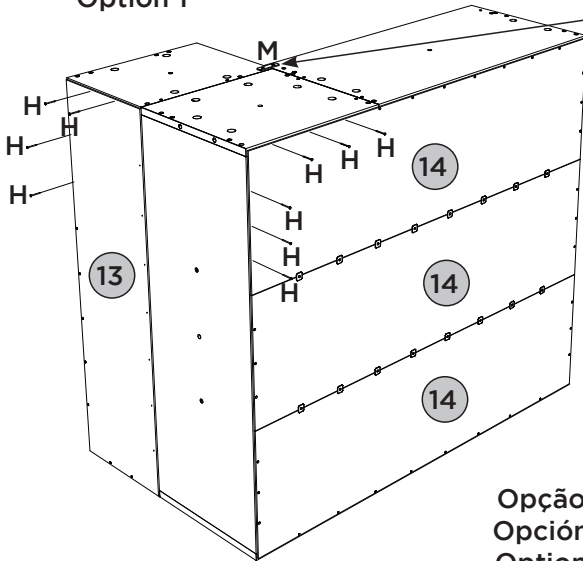

Fixar os pregos a uma distância de 100mm de um para outro.

Fixar las uñas a un distancia de 100mm uno a otro.

Fix the nails at a distance of 100mm from one to the other

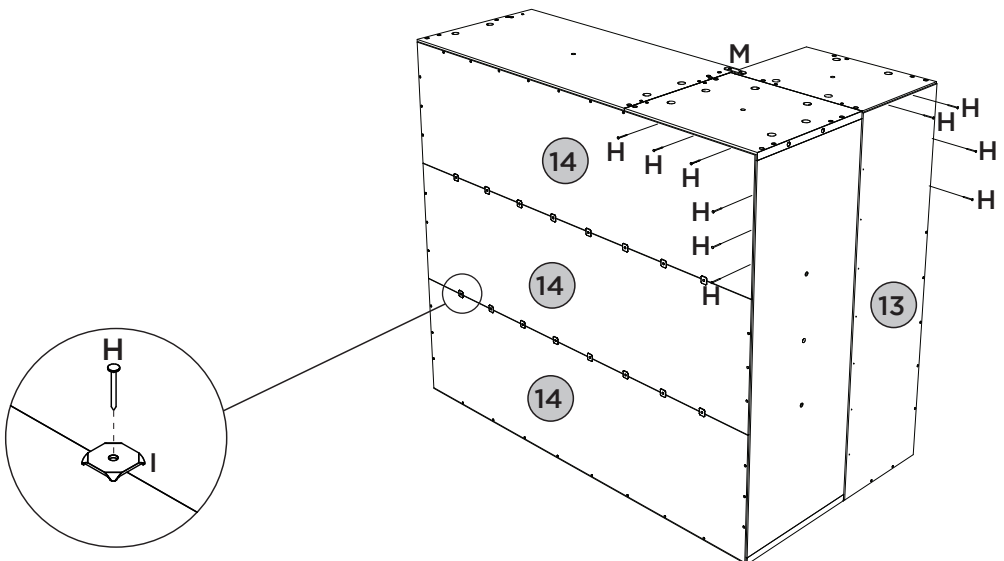

Opção 2
Opción 2
Option 2



PEÇAS REQUERIDAS

15	PORTA	x1
----	-------	----

ACESSÓRIOS REQUERIDOS

F		04
O		02



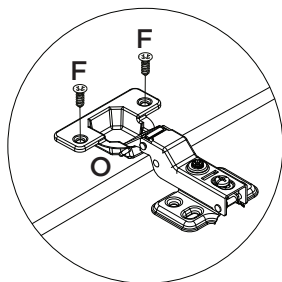
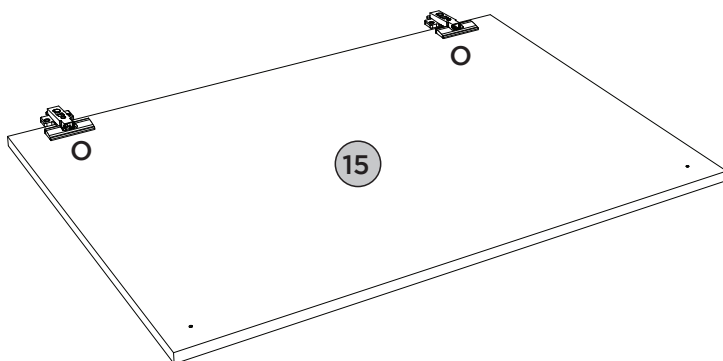
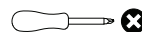

FERRAMENTAS NECESSÁRIAS

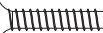

PEÇAS REQUERIDAS

15	PORTA	x1
----	-------	----

ACESSÓRIOS REQUERIDOS

C			01
F			08
N			01

FERRAMENTAS NECESSÁRIAS

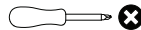

Para porta (15): Defina para o modo de perfuração.

Faça a furação passante para fixar o puxador (N).

Opção 1 Opción 1 Option 1

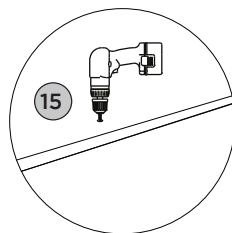
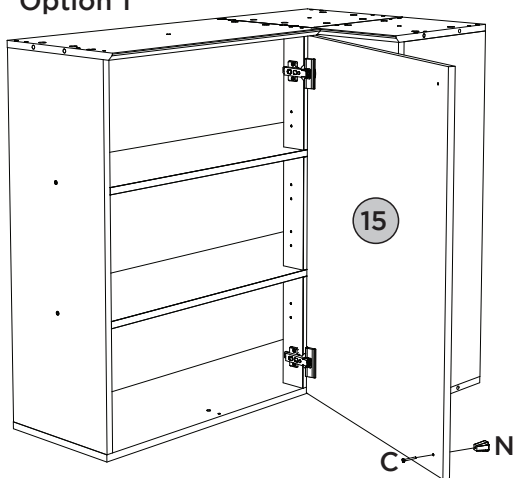

Opção 2 Opción 2 Option 2

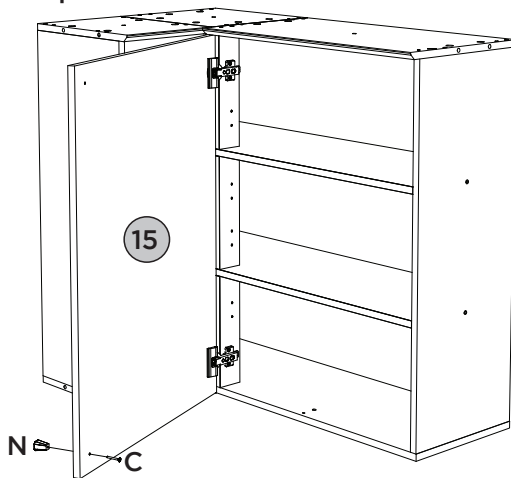
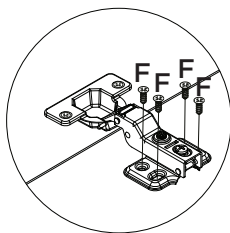

ACESSÓRIOS REQUERIDOS

A		03
F		06
P		03
Q		03
R		03
S		30
T		02

FERRAMENTAS NECESSÁRIAS



OU

Para parede: Ajustar no modo perfuração
Para peças (2, 3 e 9): Usar torque 5

Pesos máximos recomendados com carga distribuída
Peso máximo recomendado con la carga distribuida
Recommended maximum weight with distributed load.

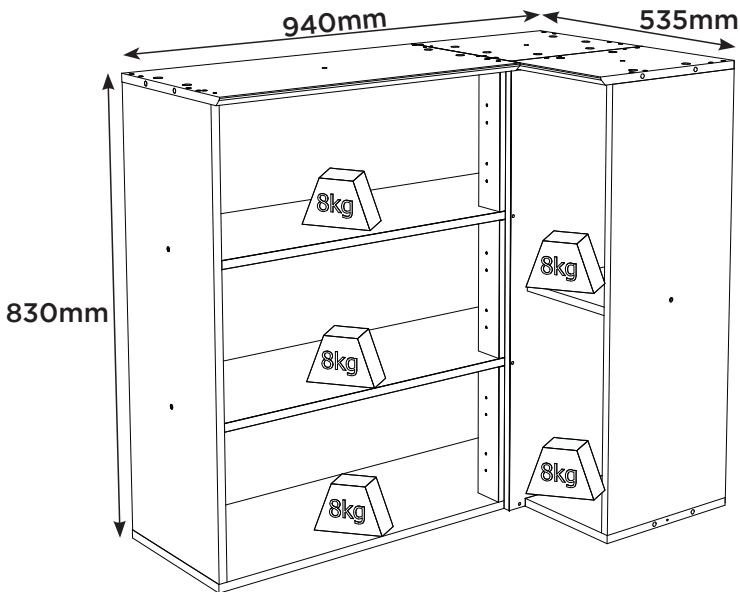

PERFECT CORRECTION
CORRECCIÓN PERFECTA

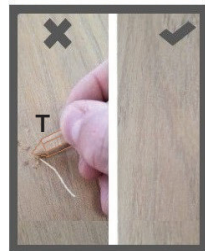

RECOMENDAÇÃO

Para fixar o móvel na parede usar o suporte de fixação (Q), o parafuso 4,0x14mm CHT (F), a Bucha 8mm (P) e o parafuso 5,0x50mm FLA (A).

RECOMENDACIÓN

Para conectar el móvil a la pared con el soporte (Q), tornillo 4,0x14mm CHT (F), el casquillo de 8 mm (P) y el 5,0 x50mm tornillo FLA (A).

RECOMMENDATION

To fix the furniture to the wall use the fixing bracket (Q), the 4,0x14mm CHT (F) screw, the 8mm bushing (P) and the 5.0x50mm FLA screw (A).

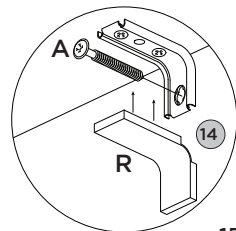
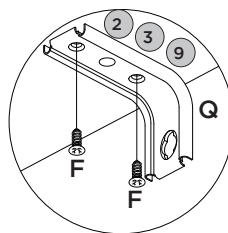
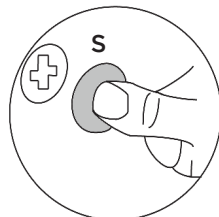

Produto Concluído
Producto terminado
Finished Product

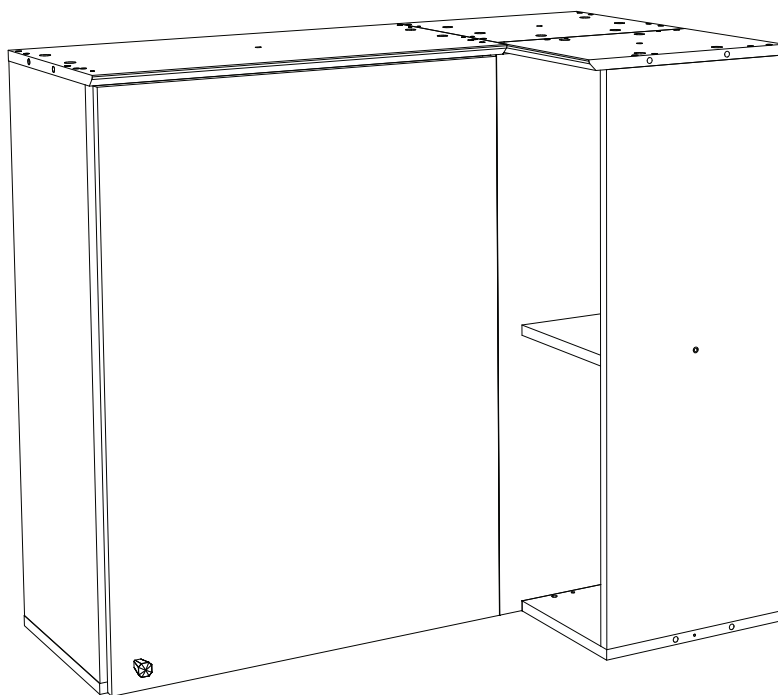

HENNInd. e Com. de Móveis Henn
Mondai - SC - Brasil

☎ +55 49 3674.3500

📱 @moveishenn
www.henn.com.br**INSTRUÇÕES DE
MONTAGEM**INSTRUCCIONES DE MONTAJE
ASSEMBLY INSTRUCTIONS**Aéreo 01 Porta 400mm Requite |
Aéreo 01 Puerta 400mm Requite |
Aerial 01 Door 400mm Requite**

C635-128 Nature

C635-217 Nature/Areia HP

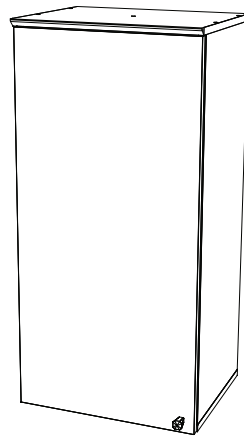
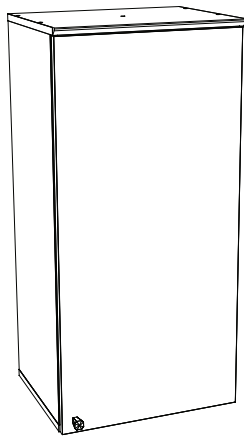
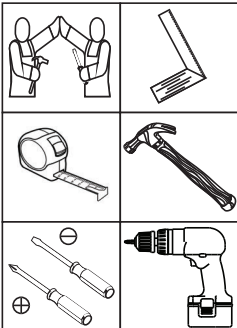
Opção 01
Opción 01
Option 01Opção 02
Opción 02
Option 02**Requisitos para montagem
Requisitos para la montaje
Assembly Requirements**

Imagens meramente ilustrativas,
não acompanha o produto.
Imágenes ilustrativas, no incluidas
con el producto.
Illustrative images, not included
with the product.

AVISO

Para limpeza de seu móvel, use uma flanela seca ou umedecida, e não utilize produtos químicos que possam danificar seu produto.

SISTEMA DE MONTAGEM

O sistema de montagem dos produtos, funciona de acordo com a ordem crescente dos números indicados no desenho. Ex: 01, 02, 03, 04... até a conclusão da montagem.

ASSISTÊNCIA TÉCNICA

Para solicitação de Assistência Técnica você consumidor deverá entrar em contato com o Lojista o qual você realizou a compra deste produto e solicitar a assistência técnica das peças avariadas. A garantia abrange todas as peças, partes e componentes que eventualmente venham apresentar defeito de fabricação no prazo de 03 (três) meses, contando a partir da entrega do produto ao consumidor, mediante nota fiscal de compra. Se houver qualquer alteração na estrutura do produto ou ocorrer defeito por negligência do montador/consumidor em relação a instrução de montagem e manuseio, não será fornecido assistência técnica gratuita.

ADVERTENCIA

Para limpieza de su móvil, use una flanela seca o húmeda, y no utilice productos químicos que puedan dañar su producto.

SISTEMA DE MONTAJE

El sistema de montaje de los productos funciona de acuerdo con el orden creciente de los números indicados en el dibujo. Ej.: 01, 02, 03, 04... hasta la conclusión del montaje.

ASISTENCIA TÉCNICA

Para solicitar Asistencia Técnica, el consumidor debe comunicarse con el Comercio que usted realizó la compra de este producto y solicita asistencia técnica para las partes dañadas. La garantía cubre todas las partes, piezas y componentes que eventualmente puedan presentar defecto de fabricación en el plazo de 03 (tres) meses, contados a partir de la entrega del producto al consumidor, mediante factura de compra. Si se produce algún cambio en la estructura del producto o se produce un defecto por negligencia del montador/consumidor en relación con las instrucciones de montaje y manipulación, no se prestará asistencia técnica gratuita.

NOTICE

To clean your furniture, use a dry or wet cloth, and do not use chemicals that may damage your product.

ASSEMBLY SYSTEM

The products' assembly system works according to the increasing order of the indicated numbers. For example: 01, 02, 03, 04 ... to the end of the assembly.

TECHNICAL ASSISTANCE

To request Technical Assistance, the consumer must contact the retailer from whom you purchased this product and request technical assistance for the damaged parts. The warranty covers all parts, parts and components that may eventually present a manufacturing defect within a period of 03 (three) months, counting from the delivery of the product to the consumer, by means of a purchase invoice. If there is any change in the structure of the product or defect occurs due to negligence of the assembler/consumer in relation to the assembly and handling instruction, free technical assistance will not be provided.

ACESSÓRIOS | ACCESORIOS | ACCESSORIES

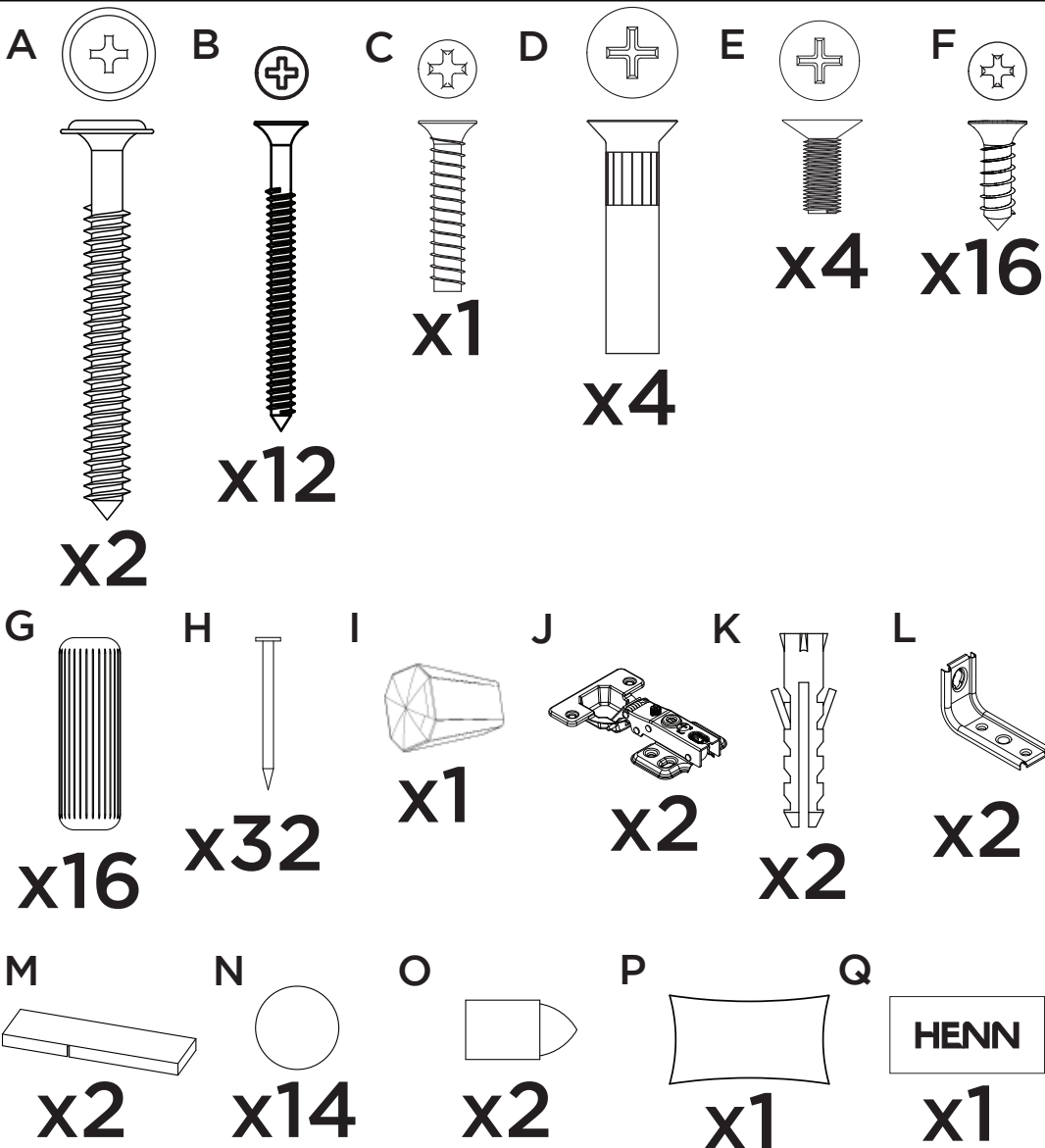

Os parafusos (D/E) devem ser usados somente quando este módulo for acoplado a outro módulo componível Henn.



Los tornillos (D/E) se debe utilizar sólo cuando el módulo está conectado a otro módulo componible Henn.



Screws (D/E) are to be used only when this module is mated to another Henn buildable module.

Parafusos em escala
Tornillos escalados
Scaled screws

1:1

LISTA DE PEÇAS | LISTA DE PIEZAS | LIST OF PIECES

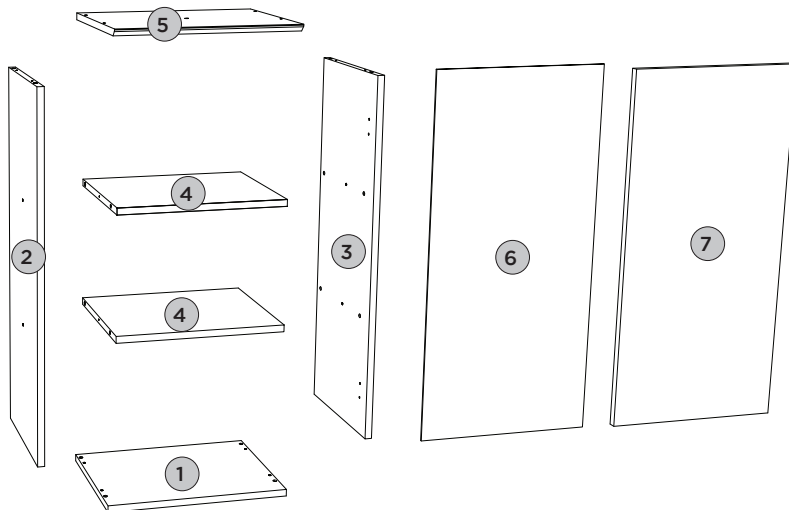

Item	Caixa Caja Box	Qty Ctd Qty	Descrição Descripción Description	Dimensões (mm) Dimensiones (mm)		
				Comprimento Largo Length	Largura Ancho Width	Espessura Grosor Thickness
1	1/1	01	BASE BASE BASE	400	295	15
2	1/1	01	LATERAL ESQUERDA LATERAL IZQUIERDA LEFT SIDE	800	295	15
3	1/1	01	LATERAL DIREITA LATERAL DERECHA RIGHT SIDE	800	295	15
4	1/1	02	PRATELEIRA ESTANTE SHELF	369	295	15
5	1/1	01	TAMPO TAPA TOP	400	322	15
6	1/1	01	FUNDO FONDO BACKGROUND	824	392	3
7	1/1	01	PORTA PUERTA DOOR	813	396	15



PASSO 1

ITM/C635-

PEÇAS REQUERIDAS

2	LATERAL ESQUERDA	x1
3	LATERAL DIREITA	x1
4	PRATELEIRA	x2

ACESSÓRIOS REQUERIDOS

G		16
P		

FERRAMENTAS NECESSÁRIAS

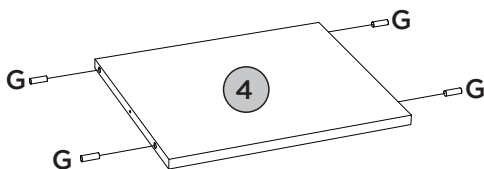
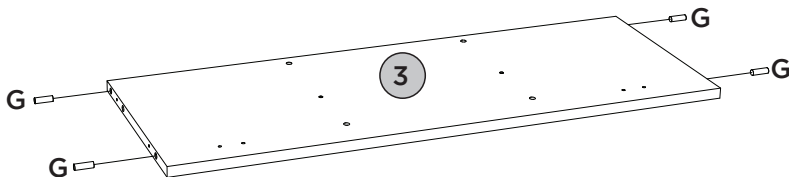
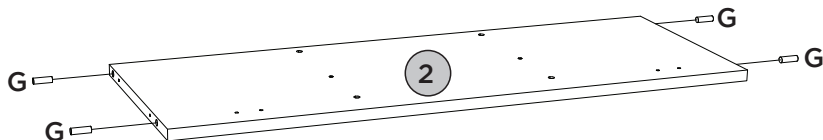
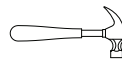

Utilizar o sachê de cola (P) em todas as cavilhas (G) do produto.



Con el pegamento sobre (P) en todos los pernos (G) producto.

Use the glue sachet (P) on all the pegs (G) of the product.

PASSO 2**PEÇAS REQUERIDAS**

1	BASE	x1
2	LATERAL ESQUERDA	x1
3	LATERAL DIREITA	x1
4	PRATELEIRA	x2
5	TAMPO	x1

ACESSÓRIOS REQUERIDOS

B		12
P		

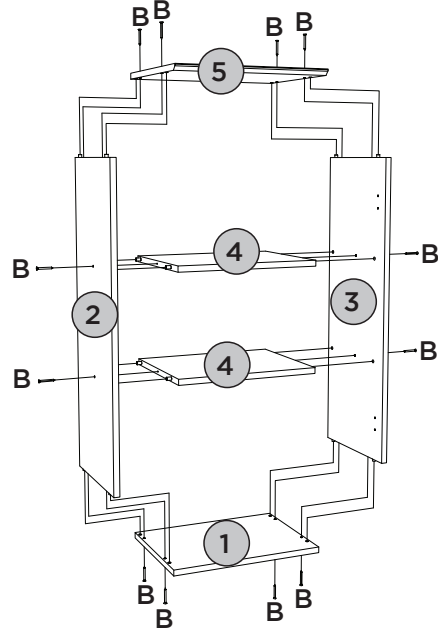
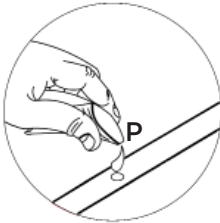
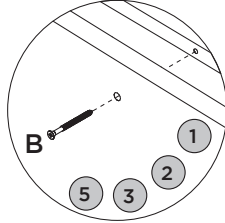
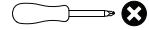
FERRAMENTAS NECESSÁRIAS**PASSO 3****PEÇAS REQUERIDAS**

6	FUNDO	x1
---	-------	----

ACESSÓRIOS REQUERIDOS

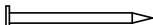
H		32
---	---	----

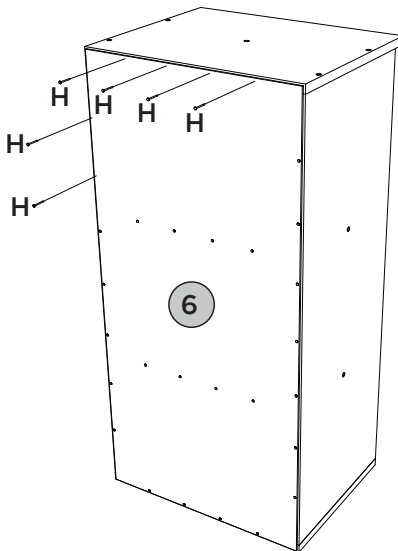
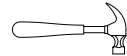
FERRAMENTAS NECESSÁRIAS

Fixar os pregos a uma distância de 100mm de um para outro.

Fijar las uñas a un distancia de 100mm uno a otro.

Fix the nails at a distance of 100mm from one to the other

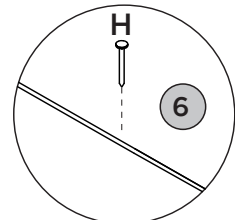



PASSO 4

ITM/C635-

PEÇAS REQUERIDAS

7	PORTA	x1
---	-------	----

ACESSÓRIOS REQUERIDOS

F	 	04
J		02

FERRAMENTAS NECESSÁRIAS

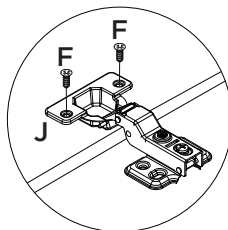
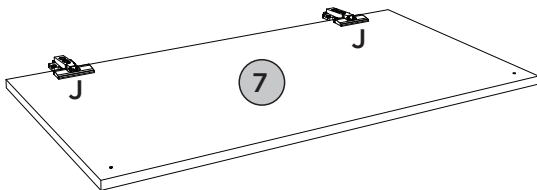
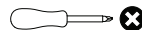





PASSO 5

PEÇAS REQUERIDAS

7	PORTA	x1
---	-------	----

ACESSÓRIOS REQUERIDOS

C	 	01
F	 	08
I		01

FERRAMENTAS NECESSÁRIAS

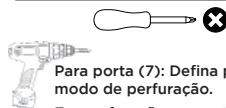

Para porta (7): Defina para o modo de perfuração.

Faça a furação passante para fixar os puxadores (I).



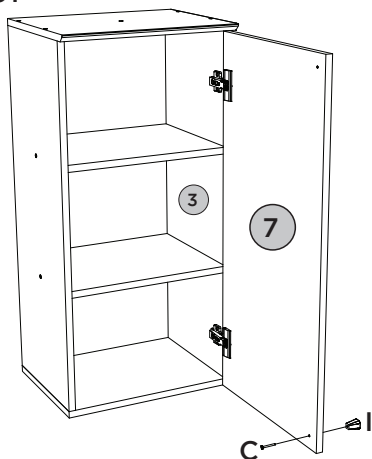

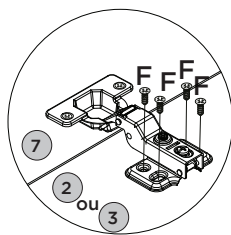
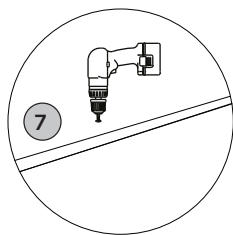
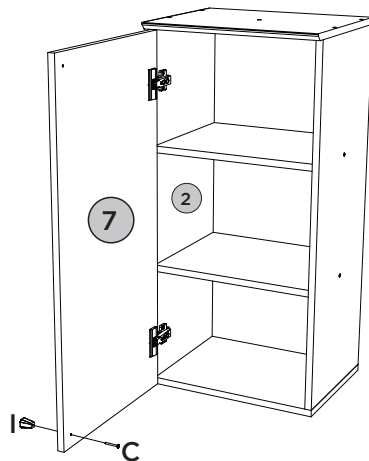

Opção 01
Opción 01
Option 01

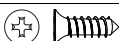
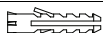

Opção 02
Opción 02
Option 02



ACESSÓRIOS REQUERIDOS

A		02
F		04
K		02
L		02
M		02
N		14
O		02
Q		01

FERRAMENTAS NECESSÁRIAS



OU

Para parede: Ajustar no modo perfuração
Para peça (02 e 03): Usar torque 5.

Pesos máximos recomendados com carga distribuída
Peso máximo recomendado con la carga distribuida
Recommended maximum weight with distributed load.

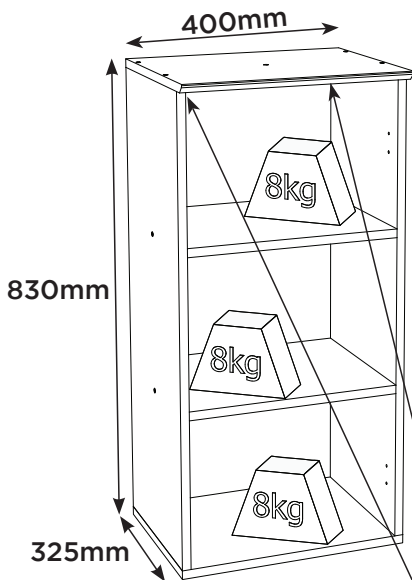

PERFECT CORRECTION
CORRECCIÓN PERFECTA

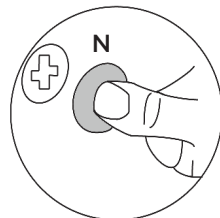
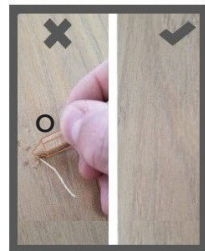

RECOMENDAÇÃO

Para fixar o móvel na parede usar o suporte de fixação (L), o parafuso 4,0x14mm CHT (F), a Bucha 8mm (K) e o parafuso 5,0x50mm FLA (A).

RECOMENDACIÓN

Para conectar el móvil a la pared con el soporte (L), tornillo 4,0x14mm CHT (F), el casquillo de 8 mm (K) y el 5,0 x50mm tornillo FLA (A).

RECOMMENDATION

To fix the furniture to the wall use the fixing bracket (L), the 4,0x14mm CHT (F) screw, the 8mm bushing (K) and the 5,0x50mm FLA screw (A).

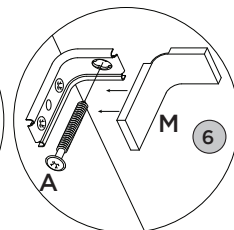
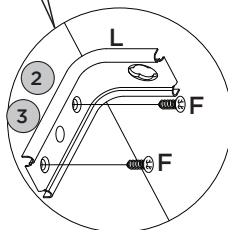

Produto Concluído
Producto terminado
Finished Product

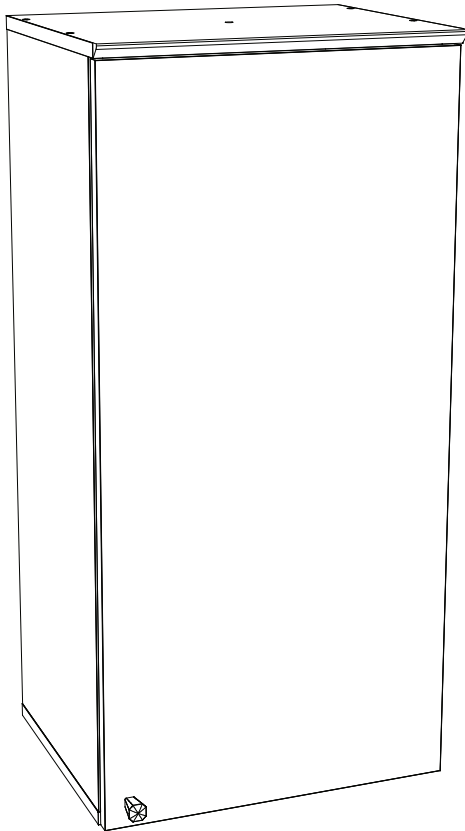
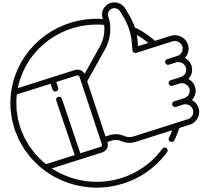

HENNInd. e Com. de Móveis Henn
Mondai - SC - Brasil

☎ +55 49 3674.3500

📷 📧 @moveishenn
www.henn.com.br**INSTRUÇÕES DE
MONTAGEM**INSTRUCCIONES DE MONTAJE
ASSEMBLY INSTRUCTIONS**Aéreo Nicho 200mm Requite |
Aéreo Niche 200mm Requite |
Aerial Niche 200mm Requite**

C637-128 Nature

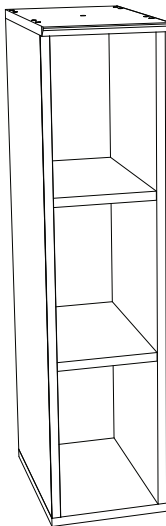
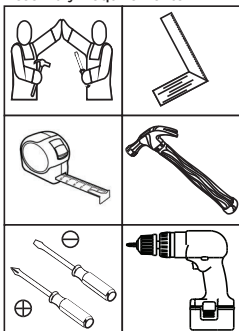
Requisitos para montagem
Requisitos para la montaje
Assembly RequirementsImagens meramente ilustrativas,
não acompanha o produto.
Imágenes ilustrativas, no incluidas
con el producto.
Illustrative images, not included
with the product.**AVISO**

Para limpeza de seu móvel, use uma franela seca ou umedecida, e não utilize produtos químicos que possam danificar seu produto.

SISTEMA DE MONTAGEM

O sistema de montagem dos produtos, funciona de acordo com a ordem crescente dos números indicados no desenho. Ex: 01, 02, 03, 04... até a conclusão da montagem.

ASSISTÊNCIA TÉCNICA

Para solicitação de Assistência Técnica você consumidor deverá entrar em contato com o Lojista o qual você realizou a compra deste produto e solicitar a assistência técnica das peças avariadas. A garantia abrange todas as peças, partes e componentes que eventualmente venham apresentar defeito de fabricação no prazo de 03 (três) meses, contando a partir da entrega do produto ao consumidor, mediante nota fiscal de compra. Se houver qualquer alteração na estrutura do produto ou ocorrer defeito por negligência do montador/consumidor em relação a instrução de montagem e manuseio, não será fornecido assistência técnica gratuita.

ADVERTENCIA

Para limpieza de su móvil, use una franela seca o húmeda, y no utilice productos químicos que puedan dañar su producto.

SISTEMA DE MONTAJE

El sistema de montaje de los productos funciona de acuerdo con el orden creciente de los números indicados en el dibujo. Ej.: 01, 02, 03, 04... hasta la conclusión del montaje.

ASISTENCIA TÉCNICA

Para solicitar Asistencia Técnica, el consumidor debe comunicarse con el Comercio que usted realizó la compra de este producto y solicita asistencia técnica para las partes dañadas. La garantía cubre todas las partes, piezas y componentes que eventualmente puedan presentar defecto de fabricación en el plazo de 03 (tres) meses, contados a partir de la entrega del producto al consumidor, mediante factura de compra. Si se produce algún cambio en la estructura del producto o se produce un defecto por negligencia del montador/consumidor en relación con las instrucciones de montaje y manipulación, no se prestará asistencia técnica gratuita.

NOTICE

To clean your furniture, use a dry or wet cloth, and do not use chemicals that may damage your product.

ASSEMBLY SYSTEM

The products' assembly system works according to the increasing order of the indicated numbers. For example: 01, 02, 03, 04 ... to the end of the assembly.

TECHNICAL ASSISTANCE

To request Technical Assistance, the consumer must contact the retailer from whom you purchased this product and request technical assistance for the damaged parts. The warranty covers all parts, parts and components that may eventually present a manufacturing defect within a period of 03 (three) months, counting from the delivery of the product to the consumer, by means of a purchase invoice. If there is any change in the structure of the product or defect occurs due to negligence of the assembler/consumer in relation to the assembly and handling instruction, free technical assistance will not be provided.

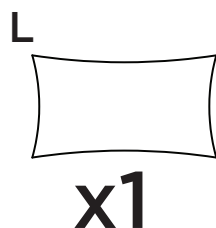
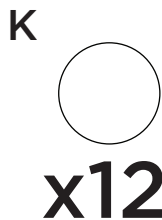
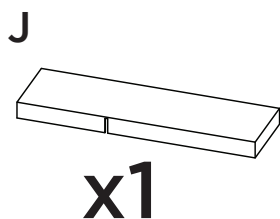
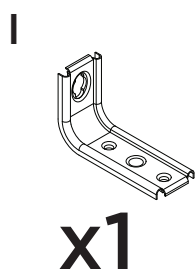
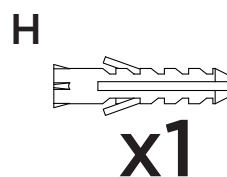
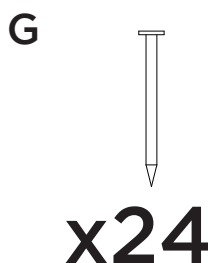
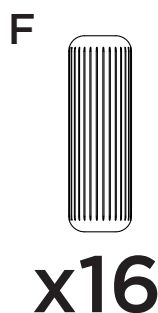
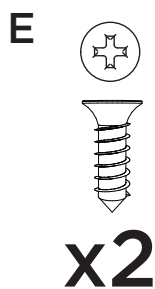
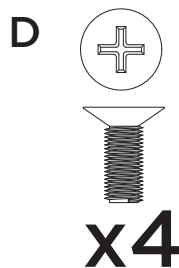
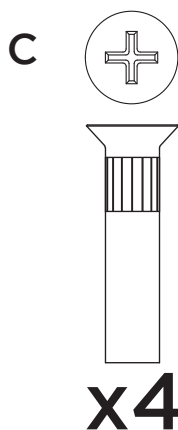
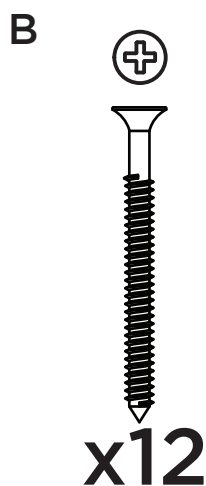
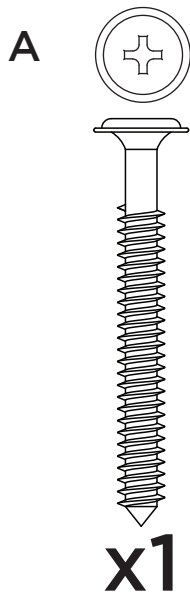

 Os parafusos (C/D) devem ser usados somente quando este módulo for acoplado a outro módulo componível Henn.

 Los tornillos (C/D) se debe utilizar sólo cuando el módulo está conectado a otro módulo componible Henn.

 Screws (C/D) are to be used only when this module is mated to another Henn buildable module.

Parafusos em escala
Tornillos escalados
Scaled screws **1:1**

LISTA DE PEÇAS | LISTA DE PIEZAS | LIST OF PIECES

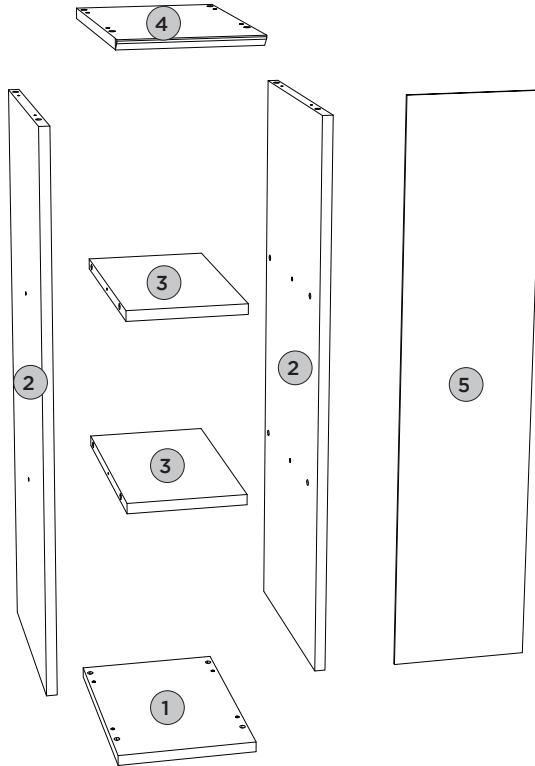

Item	Caja Caja Box	Qty Ctd Qty	Descrição Descripción Description	Dimensões (mm) Dimensiones (mm) Dimensions (mm)		
				Comprimento Largo Length	Largura Ancho Width	Espessura Grosor Thickness
1	1/1	01	BASE BASE BASE	295	200	15
2	1/1	02	LATERAL LATERAL SIDE	800	295	15
3	1/1	02	PRATELEIRA ESTANTE SHELF	293	169	15
4	1/1	01	TAMPO TAPA TOP	322	200	15
5	1/1	01	FUNDO FONDO BACKGROUND	824	193	3



PASSO 1

ITM/C637-

PEÇAS REQUERIDAS

2	LATERAL	x2
3	PRATELEIRA	x2

ACESSÓRIOS REQUERIDOS

F		16
L		

FERRAMENTAS NECESSÁRIAS

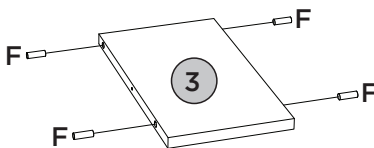
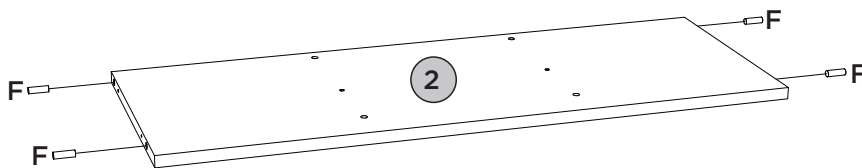

Utilizar o sachê de cola (L) em todas as cavilhas (F) do produto.

Con el pegamento sobre (L) en todos los pernos (F) producto.

Use the glue sachet (L) on all the pegs (F) of the product.



PASSO 2

ITM/C637-

PEÇAS REQUERIDAS

1	BASE	x1
2	LATERAL	x2
3	PRATELEIRA	x2
4	TAMPO	x1

ACESSÓRIOS REQUERIDOS

B			12
L			

FERRAMENTAS NECESSÁRIAS

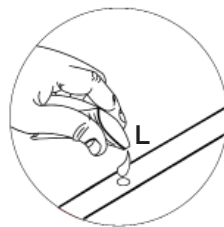
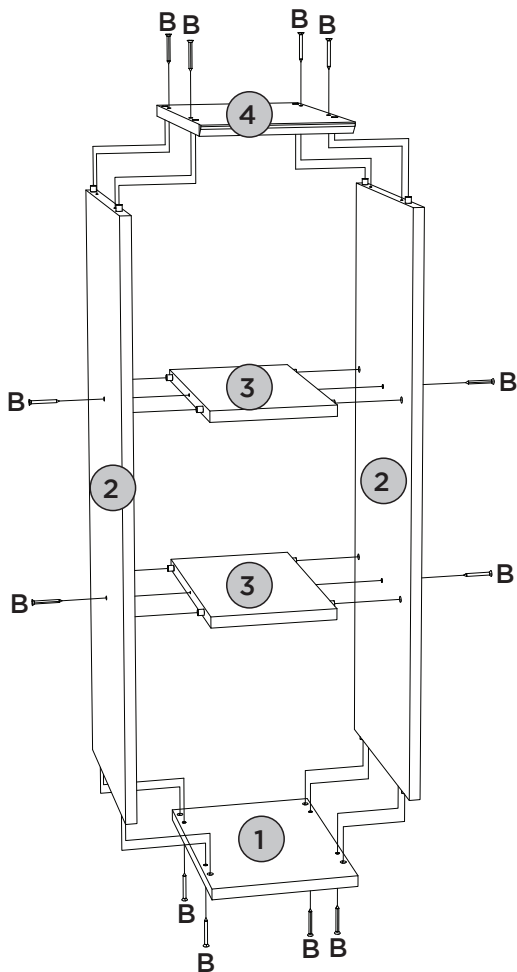
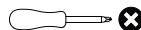

PASSO 3

ITM/C637-

PEÇAS REQUERIDAS

5	FUNDO	x1
---	-------	----

ACESSÓRIOS REQUERIDOS

G		24
---	--	----

FERRAMENTAS NECESSÁRIAS

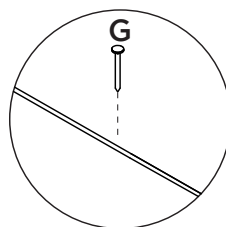
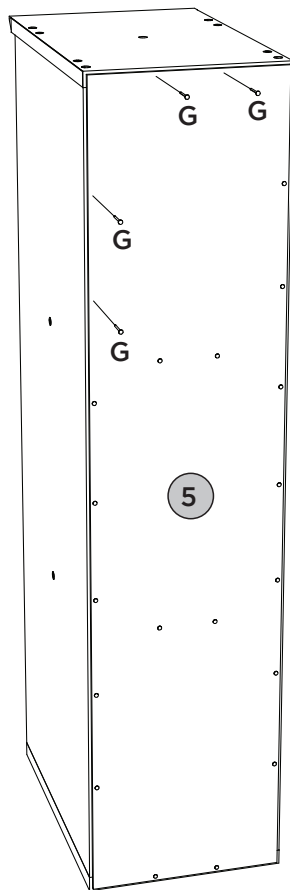
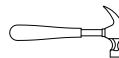

Fixar os pregos a uma distância de 100mm de um para outro.

Fijar las uñas a un distancia de 100mm uno a otro.

Fix the nails at a distance of 100mm from one to the other

ACESSÓRIOS REQUERIDOS

A		01
E		02
H		03
I		01
J		01
K		12

FERRAMENTAS NECESSÁRIAS

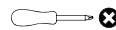

OU



Para parede: Ajustar no modo perfuração
Para peça (O4): Usar torque 5

Pesos máximos recomendados com carga distribuída
Peso máximo recomendado con la carga distribuida
Recommended maximum weight with distributed load.

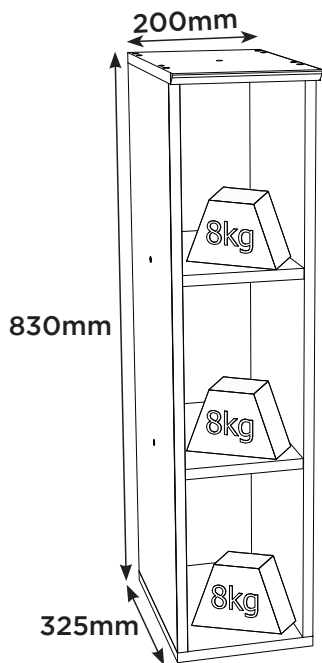

RECOMENDAÇÃO

Para fixar o móvel na parede usar o suporte de fixação (I), o parafuso 4,0x14mm CHT (E), a Bucha 8mm (H) e o parafuso 5,0x50mm FLA (A).

RECOMENDACIÓN

Para conectar el móvil a la pared con el soporte (I), tornillo 4,0 x14mm CHT (E), el casquillo de 8 mm (H) y el 5,0 x50mm tornillo FLA (A).

RECOMMENDATION

To fix the furniture to the wall use the fixing bracket (I), the 4,0x14mm CHT (E) screw, the 8mm bushing (H) and the 5,0x50mm FLA screw (A).

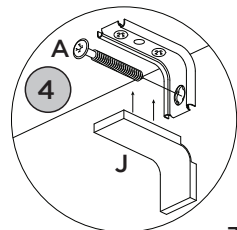
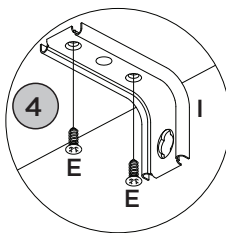
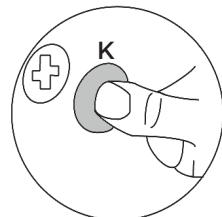

Producto Concluído
Producto terminado
Finished Product

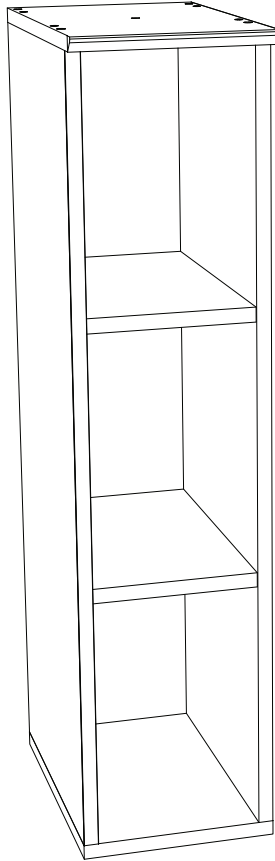

HENNInd. e Com. de Móveis Henn
Mondai - SC - Brasil

☎ +55 49 3674.3500

📷 📱 @moveishenn
www.henn.com.br**INSTRUÇÕES DE
MONTAGEM**INSTRUCCIONES DE MONTAJE
ASSEMBLY INSTRUCTIONS**Balcão 01 Porta 400mm Requite |**
Contador 01 Puerta 400mm Requite | Counter 01 Door 400mm Requite

C638-217 Nature/Areia HP

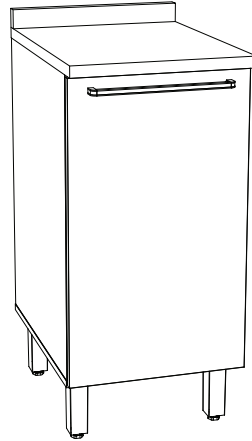
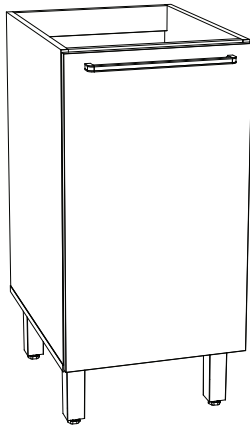
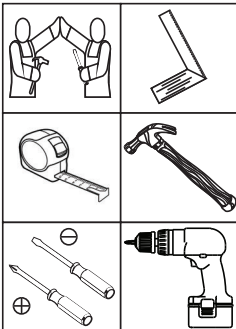
Opção
Opción
Option**Requisitos para montagem**
Requisitos para la montaje
Assembly Requirements

Imagens meramente ilustrativas,
não acompanha o produto.
Imágenes ilustrativas, no incluidas
con el producto.
Illustrative images, not included
with the product.

AVISO

Para limpeza de seu móvel, use uma franela seca ou umedecida, e não utilize produtos químicos que possam danificar seu produto.

SISTEMA DE MONTAGEM

O sistema de montagem dos produtos, funciona de acordo com a ordem crescente dos números indicados no desenho. Ex: 01, 02, 03, 04... até a conclusão da montagem.

ASSISTÊNCIA TÉCNICA

Para solicitação de Assistência Técnica você consumidor deverá entrar em contato com o Lojista o qual você realizou a compra deste produto e solicitar a assistência técnica das peças avariadas. A garantia abrange todas as peças, partes e componentes que eventualmente venham apresentar defeito de fabricação no prazo de 03 (três) meses, contando a partir da entrega do produto ao consumidor, mediante nota fiscal de compra. Se houver qualquer alteração na estrutura do produto ou ocorrer defeito por negligência do montador/consumidor em relação a instrução de montagem e manuseio, não será fornecido assistência técnica gratuita.

ADVERTENCIA

Para limpieza de su móvil, use una franela seca o húmeda, y no utilice productos químicos que puedan dañar su producto.

SISTEMA DE MONTAJE

El sistema de montaje de los productos funciona de acuerdo con el orden creciente de los números indicados en el dibujo. Ej.: 01, 02, 03, 04... hasta la conclusión del montaje.

ASSISTÊNCIA TÉCNICA

Para solicitar Assistência Técnica, o consumidor deve comunicar-se com o Comercio que usted realizou a compra de este produto y solicita asistencia técnica para las partes dañadas. La garantía cubre todas las partes, piezas y componentes que eventualmente puedan presentar defecto de fabricación en el plazo de 03 (tres) meses, contados a partir de la entrega del producto al consumidor, mediante factura de compra. Si se produce algún cambio en la estructura del producto o se produce un defecto por negligencia del montador/consumidor en relación con las instrucciones de montaje y manipulación, no se prestatá asistencia técnica gratuita.

NOTICE

To clean your furniture, use a dry or wet cloth, and do not use chemicals that may damage your product.

ASSEMBLY SYSTEM

The products' assembly system works according to the increasing order of the indicated numbers. For example: 01, 02, 03, 04 ... to the end of the assembly.

TECHNICAL ASSISTANCE

To request Technical Assistance, the consumer must contact the retailer from whom you purchased this product and request technical assistance for the damaged parts. The warranty covers all parts, parts and components that may eventually present a manufacturing defect within a period of 03 (three) months, counting from the delivery of the product to the consumer, by means of a purchase invoice. If there is any change in the structure of the product or defect occurs due to negligence of the assembler/consumer in relation to the assembly and handling instruction, free technical assistance will not be provided.

ACESSÓRIOS | ACCESORIOS | ACCESSORIES

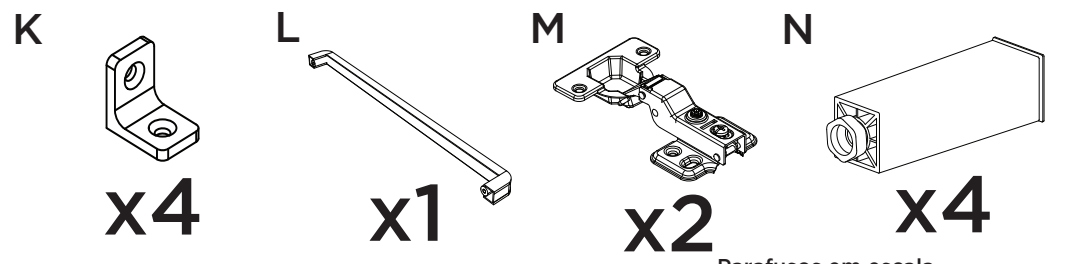
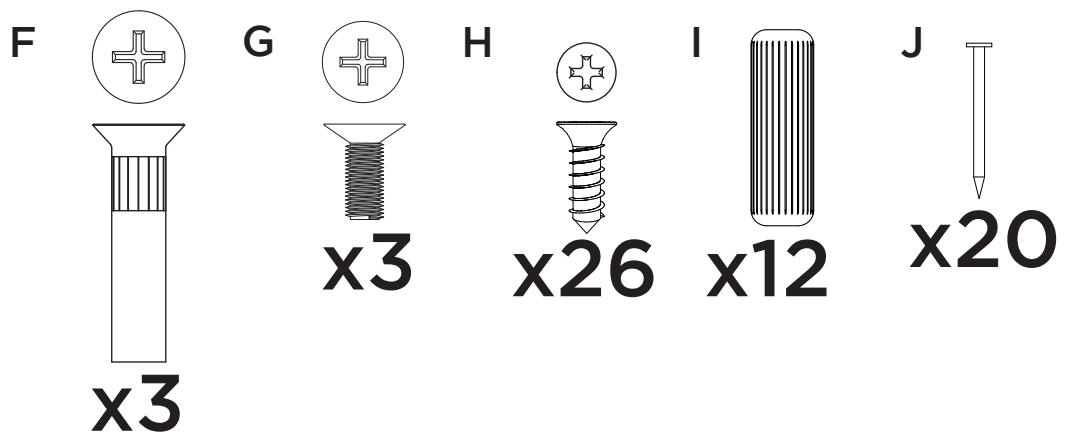
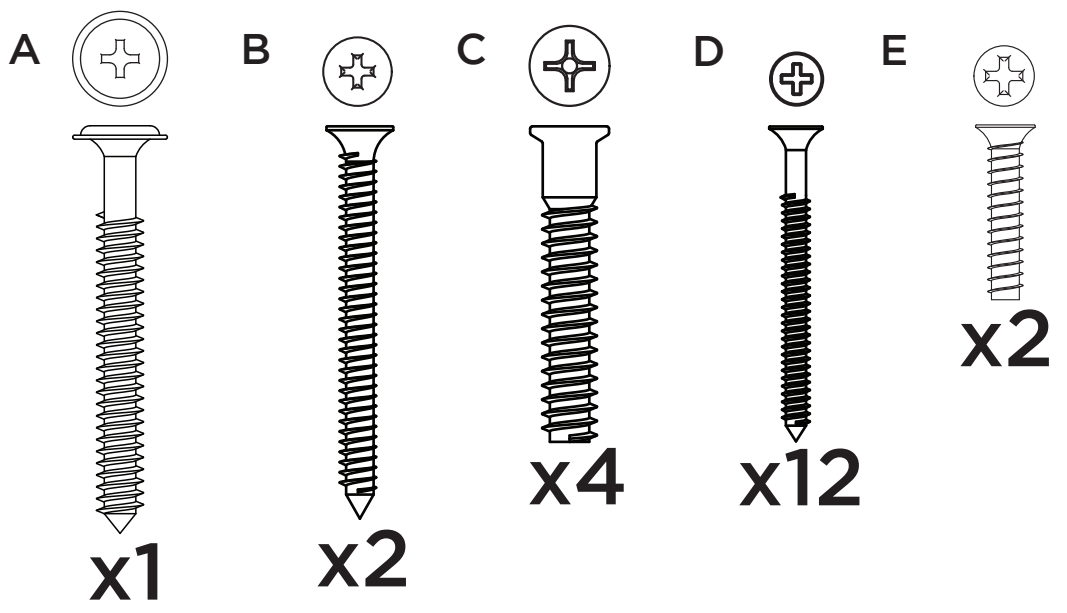

Parafusos em escala
Tornillos escalados
Scaled screws **1:1**

ACESSÓRIOS | ACCESORIOS | ACCESSORIES

O

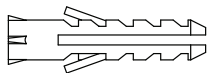

x1

P

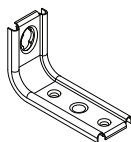

x1

Q

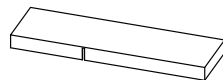

x1

R

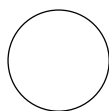

x14

S

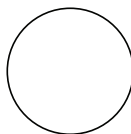

x4

T

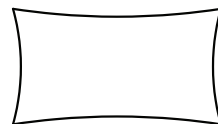

x1



Os parafusos (F/G) devem ser usados somente quando este módulo for acoplado a outro módulo componível Henn.



Los tornillos (F/G) se debe utilizar sólo cuando el módulo está conectado a otro módulo componible Henn.



Screws (F/G) are to be used only when this module is mated to another Henn buildable module.

LISTA DE PEÇAS | LISTA DE PIEZAS | LIST OF PIECES

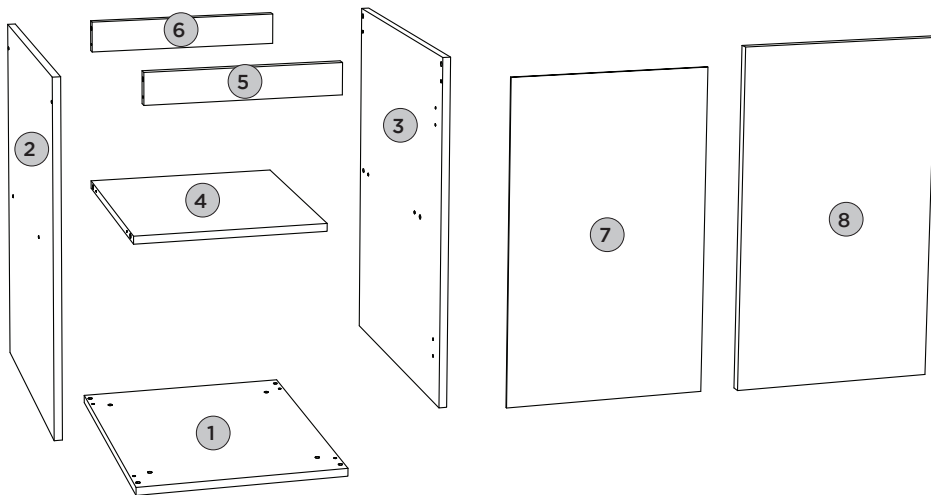

Item	Caixa Caja Box	Qty Ctd Qty	Descrição Descripción Description	Dimensões (mm) Dimensiones (mm) Dimensions (mm)		
				Comprimento Largo Length	Largura Ancho Width	Espessura Grosor Thickness
1	1/1	01	BASE BASE BASE	490	400	15
2	1/1	01	LATERAL ESQUERDA LATERAL IZQUIERDA LEFT SIDE	660	490	15
3	1/1	01	LATERAL DIREITA LATERAL DERECHA RIGHT SIDE	660	490	15
4	1/1	01	PRATELEIRA ESTANTE SHELF	400	368	15
5	1/1	01	TRAVESSA FRONTAL TRAVESAÑO FRONTAL FRONT CROSSBAR	368	60	15
6	1/1	01	TRAVESSA TRASEIRA TRAVESAÑO TRASERO REAR BUMPER	368	60	15
7	1/1	01	FUNDO FONDO BOTTOM	627	392	3
8	1/1	01	PORTA PUERTA DOOR	665	396	15





PASSO 1

ITM/C638-

PEÇAS REQUERIDAS

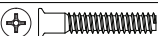
1	BASE	x1
2	LATERAL ESQUERDA	x1
3	LATERAL DIREITA	x1
4	PRATELEIRA	x1
5	TRAVESSA FRONTAL	x1
6	TRAVESSA TRASEIRA	x1

ACESSÓRIOS REQUERIDOS

C		04
I		12
N		04
T		

FERRAMENTAS NECESSÁRIAS

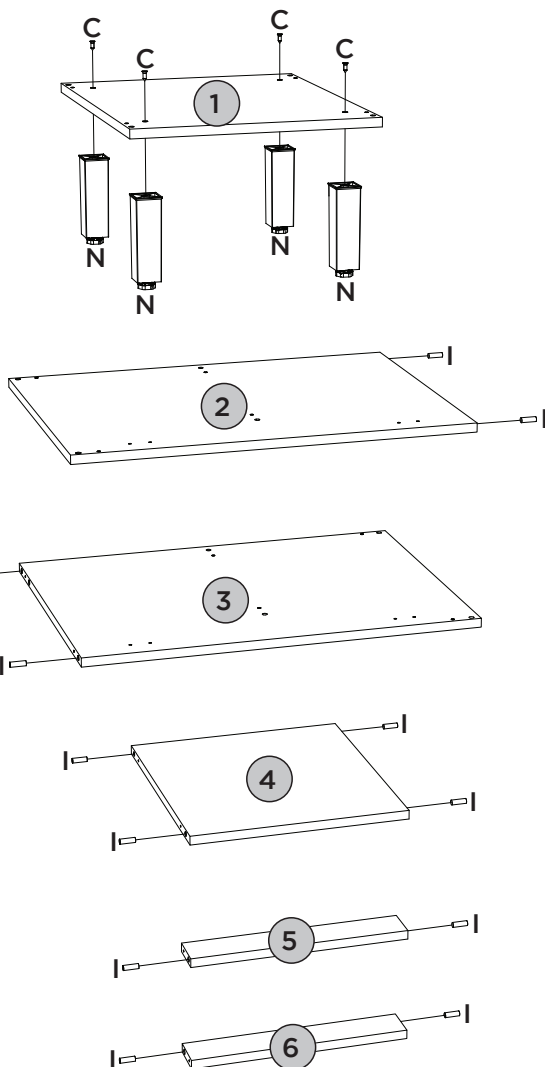
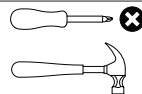

Utilizar o sachê de cola (T) em todas as cavilhas (I) do produto.

Con el pegamento sobre (T) en todos los pernos (I) producto.

Use the glue sachet (T) on all the pegs (I) of the product.



PASSO 2

ITM/C638-

PEÇAS REQUERIDAS

1	BASE	x1
2	LATERAL ESQUERDA	x1
3	LATERAL DIREITA	x1
4	PRATELEIRA	x1
5	TRAVESSA FRONTAL	x1
6	TRAVESSA TRASEIRA	x1





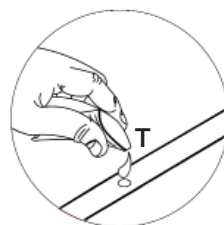
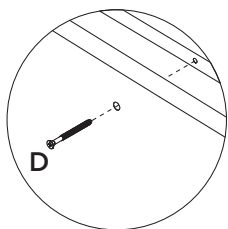
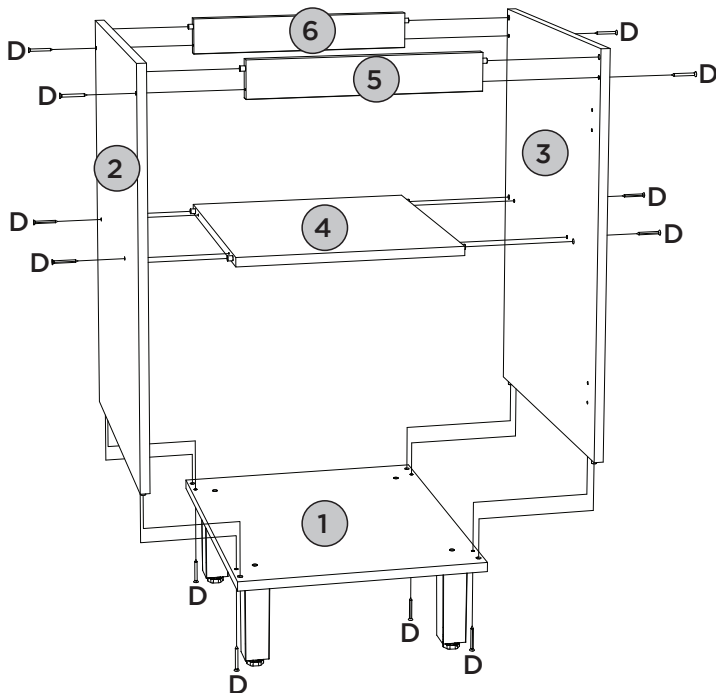
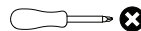

ACESSÓRIOS REQUERIDOS

D			12
T			

FERRAMENTAS NECESSÁRIAS



ACESSÓRIOS REQUERIDOS

B			02
H			08
K			04

FERRAMENTAS NECESSÁRIAS

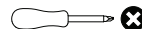

Esse tampo é opcional e é vendido separadamente (C902-128).

Esta vez es opcional y se vende por separado (C902-128).

This top is optional and is sold separately (C902-128).

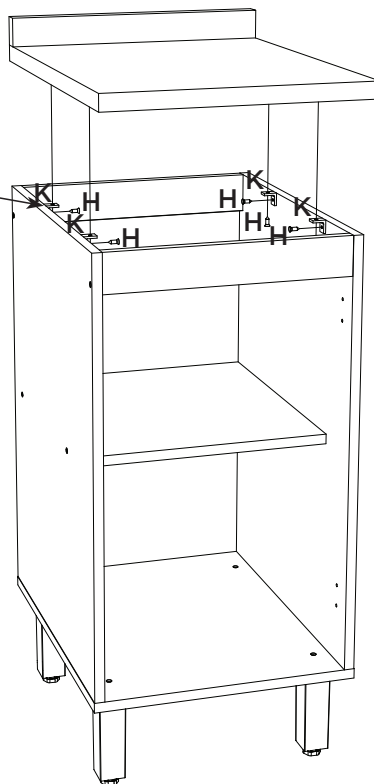
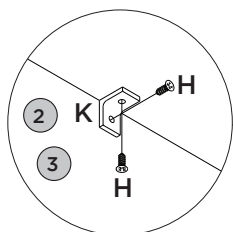
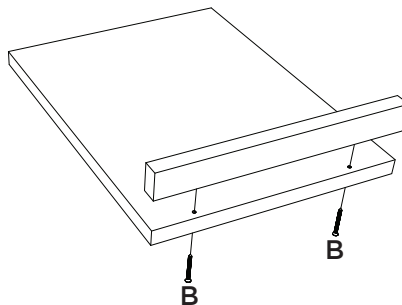

PASSO 4

ITM/C638-

PEÇAS REQUERIDAS

7	FUNDO	x1
---	-------	----

ACESSÓRIOS REQUERIDOS

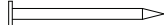
H		04
J		20

FERRAMENTAS NECESSÁRIAS

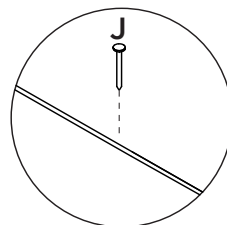
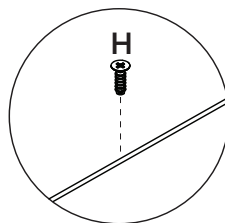
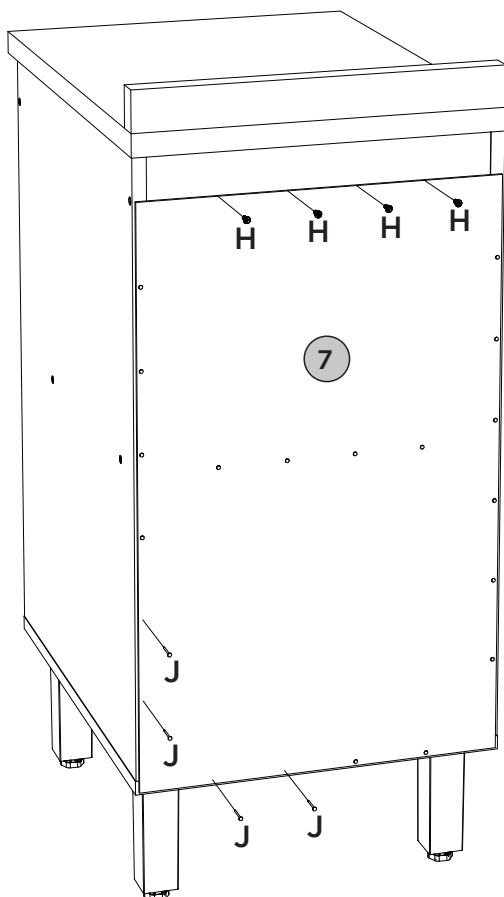
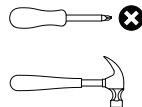

Fixar os pregos a uma distância de 100mm de um para outro.



Fijar las uñas a un distancia de 100mm uno a otro.

Fix the nails at a distance of 100mm from one to the other

PEÇAS REQUERIDAS

8	PORTA	x1
---	-------	----

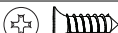
ACESSÓRIOS REQUERIDOS

H		04
M		02



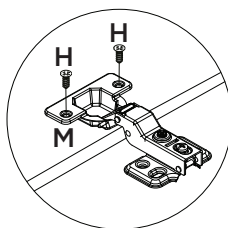
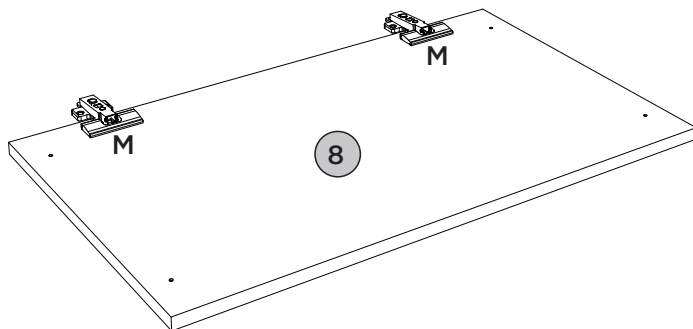
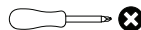

FERRAMENTAS NECESSÁRIAS



PEÇAS REQUERIDAS

8	PORTA	x1
---	-------	----

ACESSÓRIOS REQUERIDOS

E	 	02
H	 	08
L		01

FERRAMENTAS NECESSÁRIAS

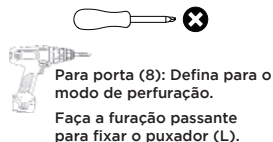



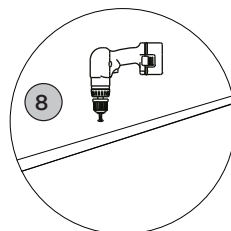
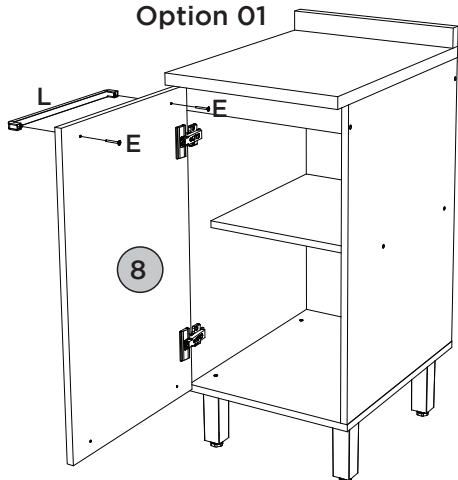

Opção 01
Opción 01
Option 01

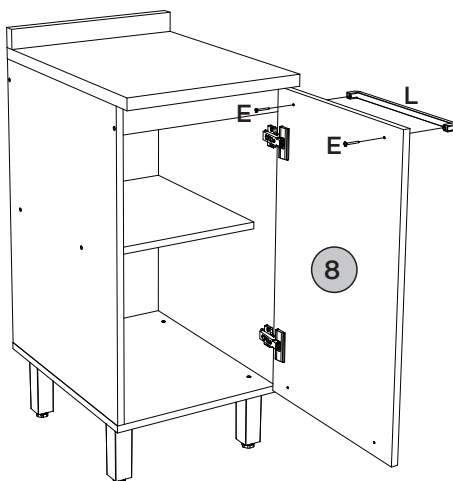
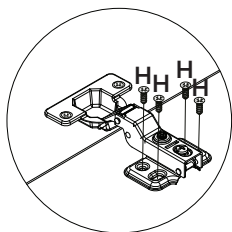



Opção 02
Opción 02
Option 02



ACESSÓRIOS REQUERIDOS

A		01
H		02
O		01
P		01

Q		01
R		14
S		04

FERRAMENTAS NECESSÁRIAS



OU

Para parede: Ajustar no modo perfuração

Pesos máximos recomendados com carga distribuída
Peso máximo recomendado con la carga distribuida
Recommended maximum weight with distributed load.

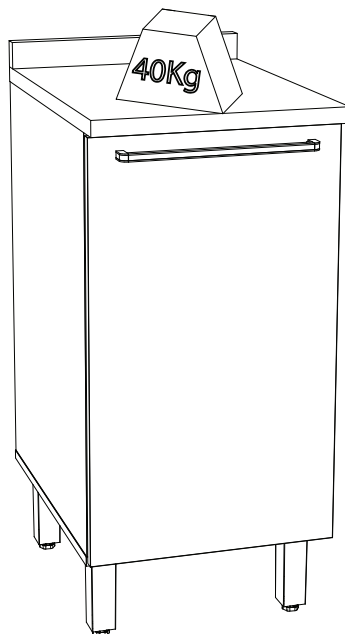
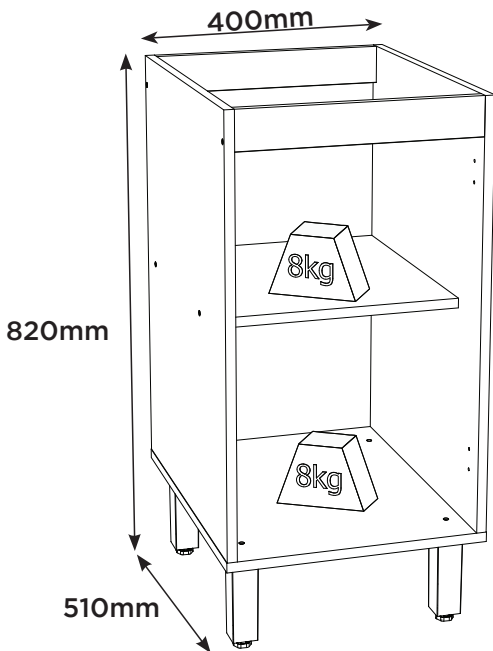

RECOMENDAÇÃO

Para fixar o móvel na parede usar o suporte de fixação (P), o parafuso 4,0x14mm CHT (H), a Bucha 8mm (O) e o parafuso 5,0x50mm FLA (A).

RECOMENDACIÓN

Para conectar el móvil a la pared con el soporte (P), tornillo 4,0x14mm CHT (H), el casquillo de 8 mm (O) y el 5,0 x50mm tornillo FLA (A).

RECOMMENDATION

To fix the furniture to the wall use the fixing bracket (P), the 4,0x14mm CHT (H) screw, the 8mm bushing (O) and the 5.0x50mm FLA screw (A).

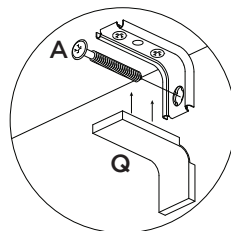
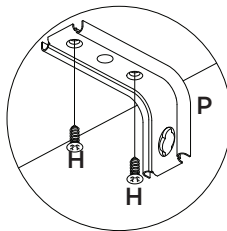
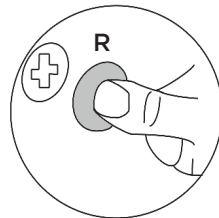
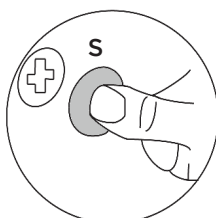

Producto Concluído
Producto terminado
Finished Product

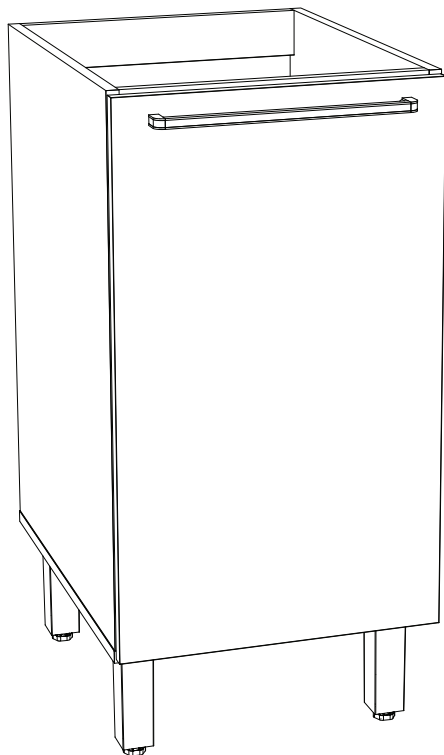

HENNInd. e Com. de Móveis Henn
Mondai - SC - Brasil

☎ +55 49 3674.3500

📧 @moveishenn
www.henn.com.br**INSTRUÇÕES DE
MONTAGEM**INSTRUCCIONES DE MONTAJE
ASSEMBLY INSTRUCTIONS**Balcão 02 Portas 800mm Requite |**

Contador 02 Puertas 800mm Requite | Counter 02 Doors 800mm Requite

C639-217 Nature/Areia HP

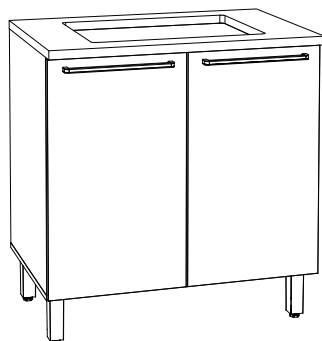
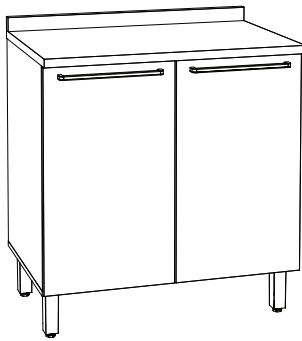
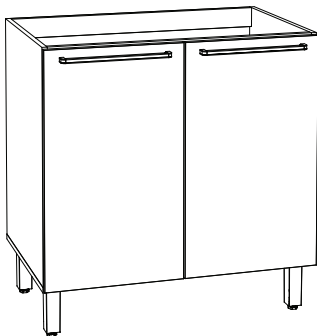
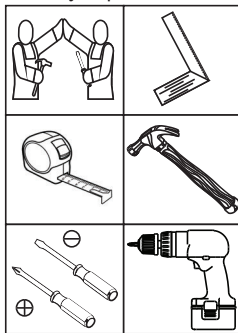
Opção 01
Opción 01
Option 01Opção 02
Opción 02
Option 02**Requisitos para montagem
Requisitos para la montaje
Assembly Requirements**

Imagens meramente ilustrativas,
não acompanha o produto.
Imágenes ilustrativas, no incluidas
con el producto.
Illustrative images, not included
with the product.

AVISO

Para limpeza de seu móvel, use uma franela seca ou umedecida, e não utilize produtos químicos que possam danificar seu produto.

SISTEMA DE MONTAGEM

O sistema de montagem dos produtos, funciona de acordo com a ordem crescente dos números indicados no desenho. Ex: 01, 02, 03, 04... até a conclusão da montagem.

ASSISTÊNCIA TÉCNICA

Para solicitação de Assistência Técnica você consumidor deverá entrar em contato com o Lojista a qual você realizou a compra deste produto e solicitar a assistência técnica das peças avariadas. A garantia abrange todas as peças, partes e componentes que eventualmente venham apresentar defeito de fabricação no prazo de 03 (três) meses, contando a partir da entrega do produto ao consumidor, mediante nota fiscal de compra. Se houver qualquer alteração na estrutura do produto ou ocorrer defeito por negligência do montador/consumidor em relação a instrução de montagem e manuseio, não será fornecido assistência técnica gratuita.

ADVERTENCIA

Para limpieza de su móvil, use una franela seca o húmeda, y no utilice productos químicos que puedan dañar su producto.

SISTEMA DE MONTAJE

El sistema de montaje de los productos funciona de acuerdo con el orden creciente de los números indicados en el dibujo. Ej.: 01, 02, 03, 04... hasta la conclusión del montaje.

ASSISTÊNCIA TÉCNICA

Para solicitar Asistencia Técnica, el consumidor debe comunicarse con el Comercio que usted realizó la compra de este producto y solicita asistencia técnica para las partes dañadas. La garantía cubre todas las partes, piezas y componentes que eventualmente puedan presentar defecto de fabricación en el plazo de 03 (tres) meses, contados a partir de la entrega del producto al consumidor, mediante factura de compra. Si se produce algún cambio en la estructura del producto o se produce un defecto por negligencia del montador/consumidor en relación con las instrucciones de montaje y manipulación, no se prestará asistencia técnica gratuita.

NOTICE

To clean your furniture, use a dry or wet cloth, and do not use chemicals that may damage your product.

ASSEMBLY SYSTEM

The products' assembly system works according to the increasing order of the indicated numbers. For example: 01, 02, 03, 04 ... to the end of the assembly.

TECHNICAL ASSISTANCE

To request Technical Assistance, the consumer must contact the retailer from whom you purchased this product and request technical assistance for the damaged parts. The warranty covers all parts, parts and components that may eventually present a manufacturing defect within a period of 03 (three) months, counting from the delivery of the product to the consumer, by means of a purchase invoice. If there is any change in the structure of the product or defect occurs due to negligence of the assembler/consumer in relation to the assembly and handling instruction, free technical assistance will not be provided.

ACESSÓRIOS | ACCESORIOS | ACCESSORIES

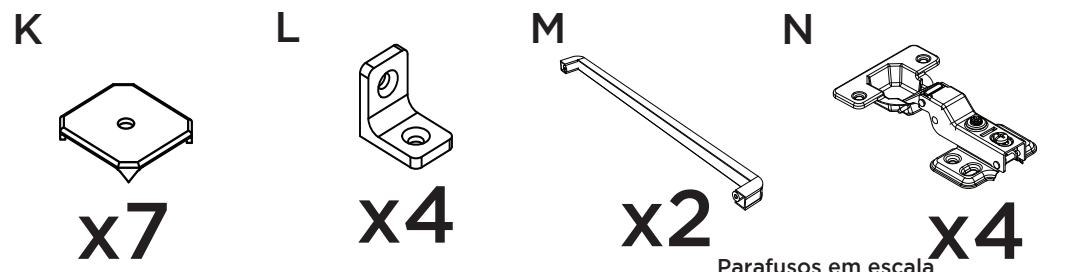
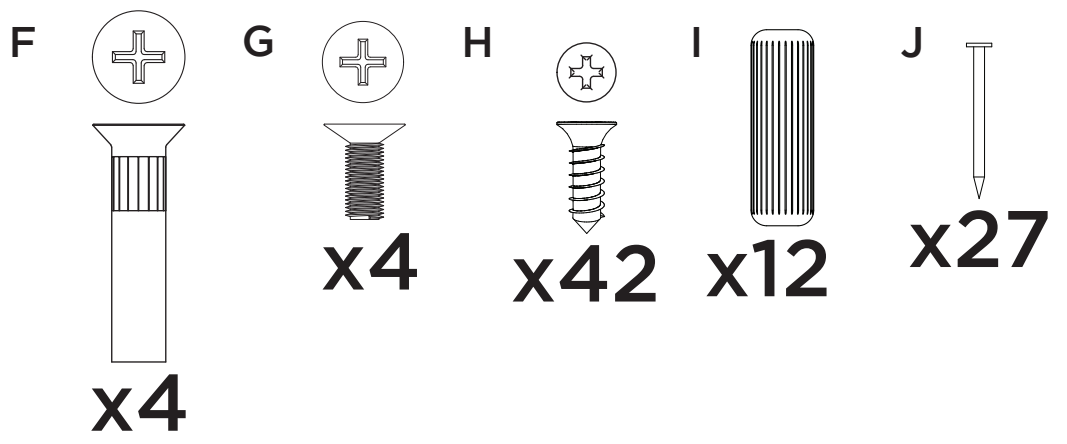
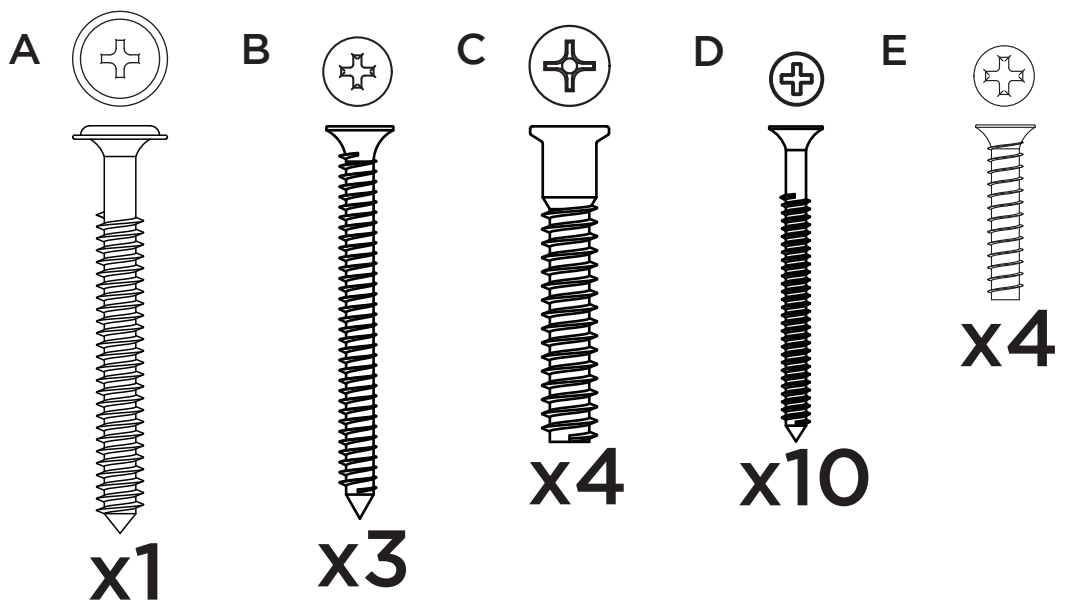

Parafusos em escala
Tornillos escalados
Scaled screws **1:1**

ACESSÓRIOS | ACCESORIOS | ACCESSORIES

O

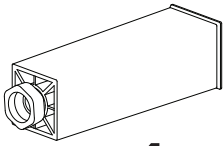

x4

P

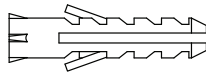

x1

Q

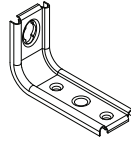

x1

R

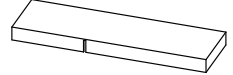

x1

S

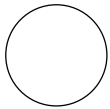

x14

T

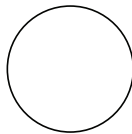

x4

U

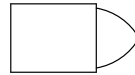

x3

V

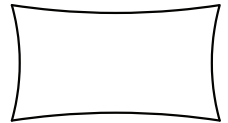

x1



Os parafusos (F/G) devem ser usados somente quando este módulo for acoplado a outro módulo componível Henn.



Los tornillos (F/G) se debe utilizar sólo cuando el módulo está conectado a otro módulo componible Henn.



Screws (F/G) are to be used only when this module is mated to another Henn buildable module.

LISTA DE PEÇAS | LISTA DE PIEZAS | LIST OF PIECES

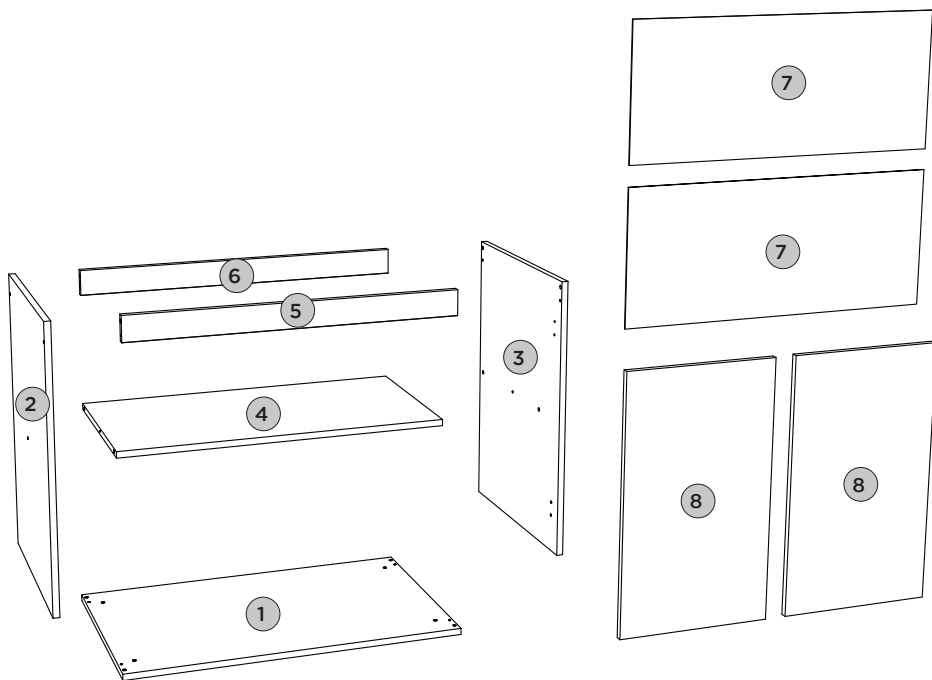

Item	Caixa Caja Box	Qtd Ctd Qty	Descrição Descripción Description	Dimensões (mm) Dimensiones (mm) Dimensions (mm)		
				Comprimento Largo Length	Largura Ancho Width	Espessura Grosor Thickness
1	1/1	01	BASE BASE BASE	800	490	15
2	1/1	01	LATERAL ESQUERDA LATERAL IZQUIERDA LEFT SIDE	660	490	15
3	1/1	01	LATERAL DIREITA LATERAL DERECHA RIGHT SIDE	660	490	15
4	1/1	01	PRATELEIRA ESTANTE SHELF	768	400	15
5	1/1	01	TRAVESSA FRONTAL TRAVESAÑO FRONTAL FRONT CROSSBAR	768	60	15
6	1/1	01	TRAVESSA TRASEIRA TRAVESAÑO TRASERO REAR BUMPER	768	60	15
7	1/1	02	FUNDO FONDO BOTTOM	792	335	3
8	1/1	02	PORTA PUERTA DOOR	665	396	15





PASSO 1

ITM/C639-

PEÇAS REQUERIDAS

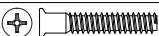
1	BASE	x1
2	LATERAL ESQUERDA	x1
3	LATERAL DIREITA	x1
4	PRATELEIRA	x1
5	TRAVESSA FRONTAL	x1
6	TRAVESSA TRASEIRA	x1

ACESSÓRIOS REQUERIDOS

C		04
I		12
O		04
V		

FERRAMENTAS NECESSÁRIAS

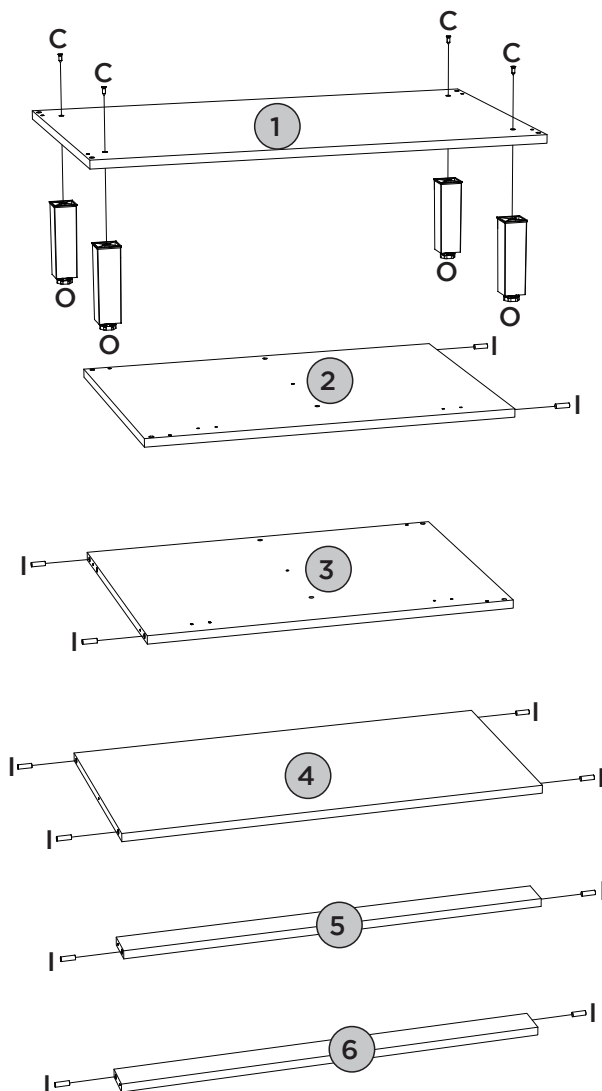
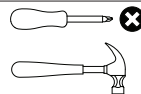

Utilizar o sachê de cola (V) em todas as cavilhas (I) do produto.



Con el pegamento sobre (V) en todos los pernos (I) producto.

Use the glue sachet (V) on all the pegs (I) of the product.

PASSO 2**PEÇAS REQUERIDAS**



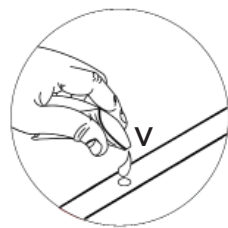
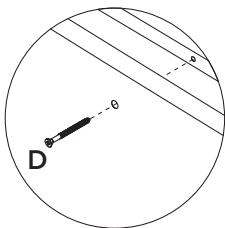
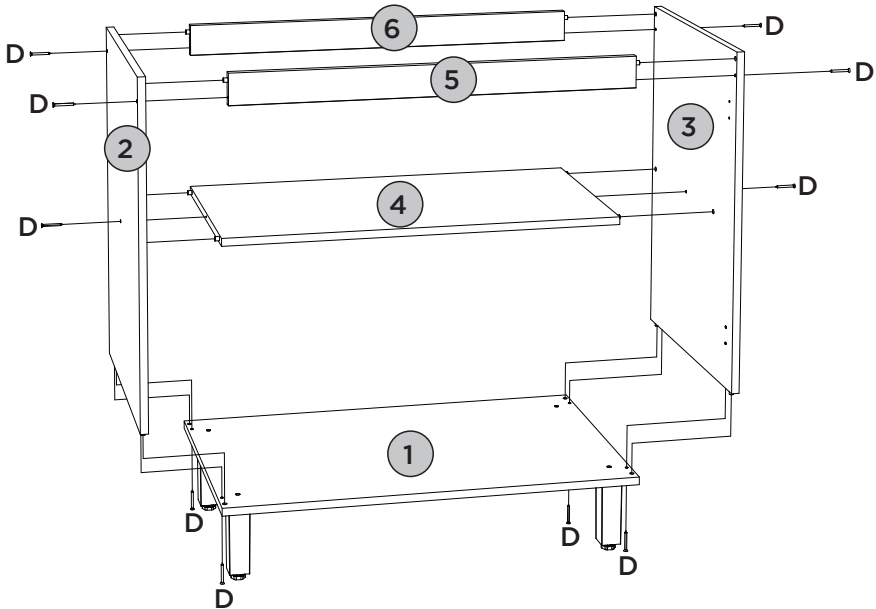
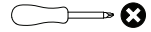

1	BASE	x1
2	LATERAL ESQUERDA	x1
3	LATERAL DIREITA	x1
4	PRATELEIRA	x1
5	TRAVESSA FRONTAL	x1
6	TRAVESSA TRASEIRA	x1

ACESSÓRIOS REQUERIDOS

D		10
V		

FERRAMENTAS NECESSÁRIAS

ACESSÓRIOS REQUERIDOS

B			03
H			08
L			04

FERRAMENTAS NECESSÁRIAS

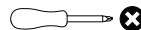

Esse tampo é opcional e é vendido separadamente (C904-128).

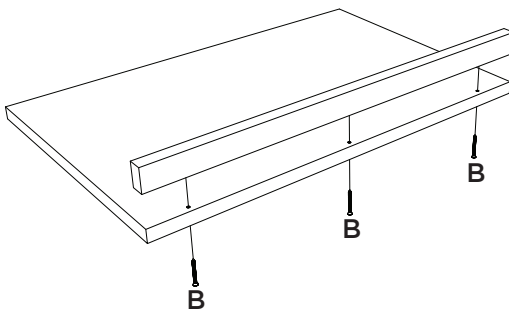



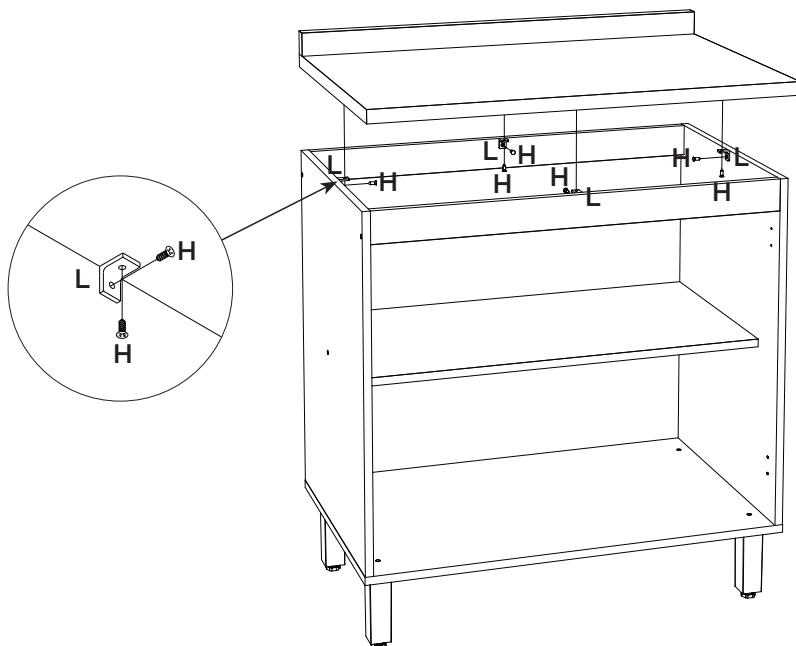

Esta vez es opcional y se vende por separado (C904-128).

This top is optional and is sold separately (C904-128).



ACESSÓRIOS REQUERIDOS

H			08
L			04

FERRAMENTAS NECESSÁRIAS

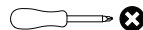

Esse tampo é opcional e é vendido separadamente (C908-128).

Esta vez es opcional y se vende por separado (C908-128).

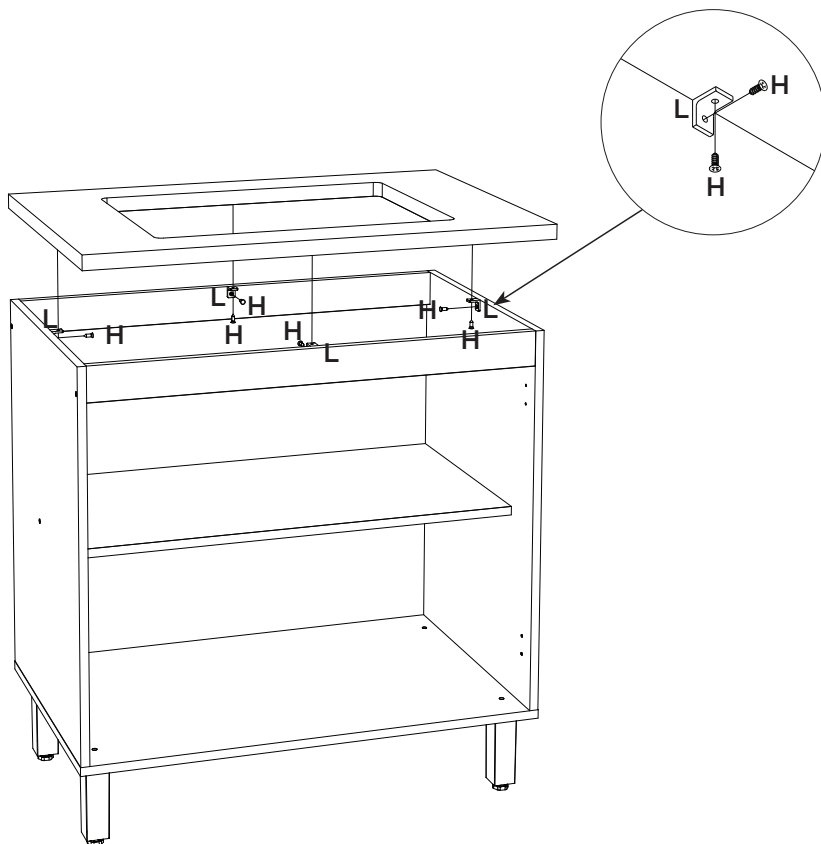

This top is optional and is sold separately (C908-128).



PEÇAS REQUERIDAS

7	FUNDO	x2
---	-------	----

ACESSÓRIOS REQUERIDOS

H		08
J		27
K		07

FERRAMENTAS NECESSÁRIAS

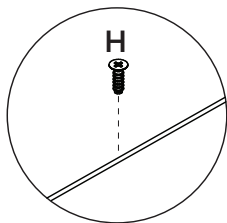
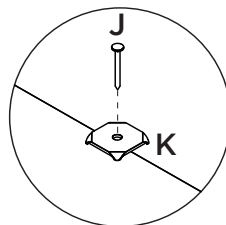
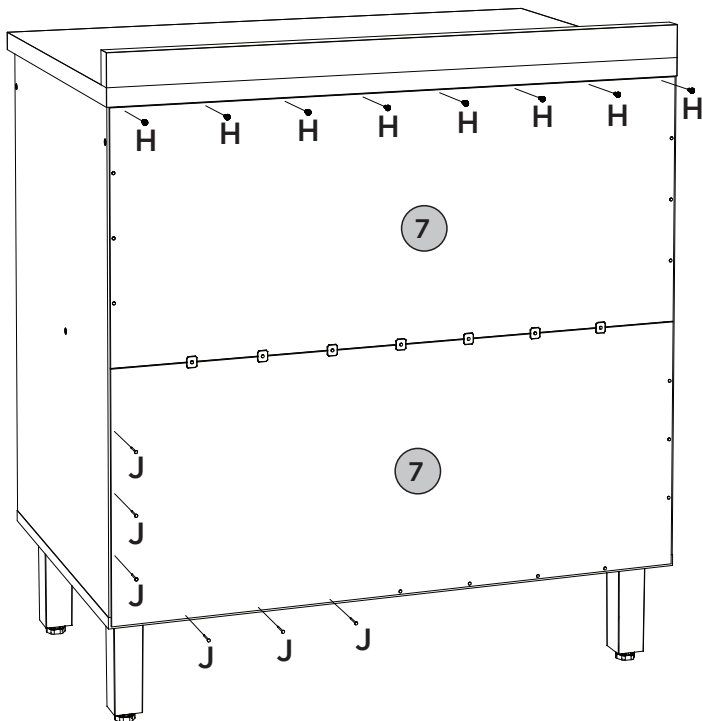
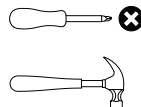

Fixar os pregos a uma distância de 100mm de um para outro.



Fijar las uñas a un distancia de 100mm uno a otro.

Fix the nails at a distance of 100mm from one to the other

PASSO 6**PEÇAS REQUERIDAS**

8	PORTA	x2
---	-------	----

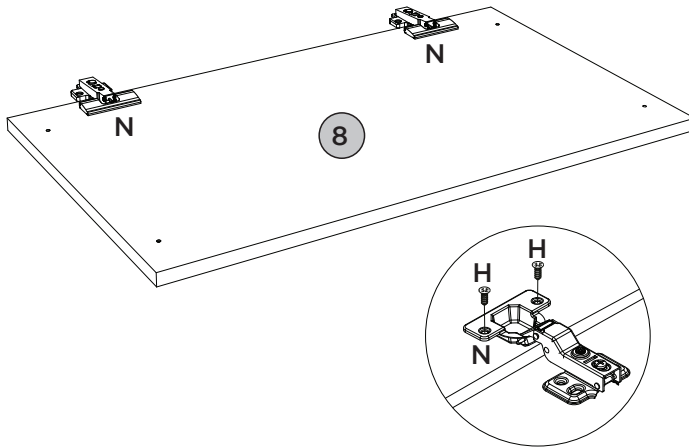
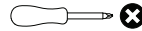

ACESSÓRIOS REQUERIDOS

H		08
N		04

FERRAMENTAS NECESSÁRIAS**PASSO 7****PEÇAS REQUERIDAS**

8	PORTA	x2
---	-------	----

ACESSÓRIOS REQUERIDOS

E		04
H		16
M		02

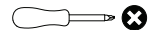
FERRAMENTAS NECESSÁRIAS

Para porta (8): Defina para o modo de perfuração.

Faça a furação passante para fixar o puxador (M).

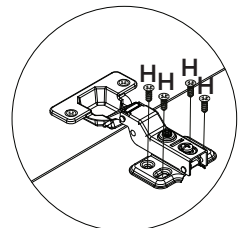
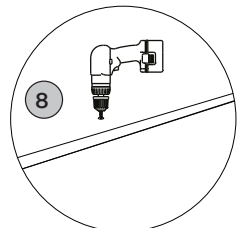
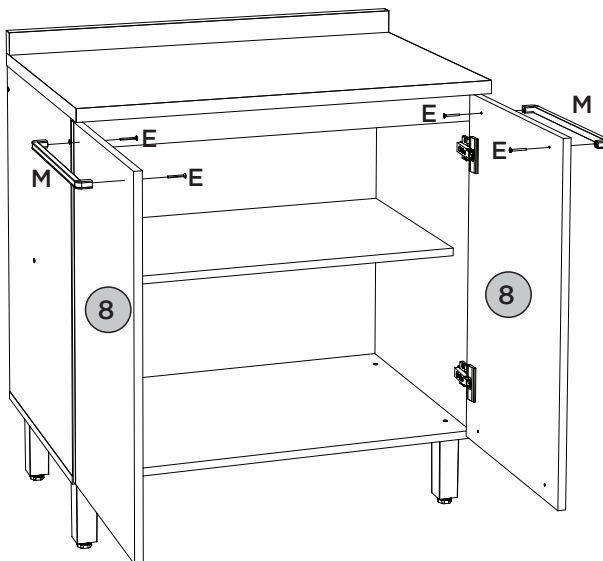

ACESSÓRIOS REQUERIDOS

A		01	R		01
H		02	S		14
P		01	T		04
Q		01	U		03

FERRAMENTAS NECESSÁRIAS



OU



Para parede: Ajustar no modo perfuração

Pesos máximos recomendados com carga distribuída
Peso máximo recomendado con la carga distribuida
Recommended maximum weight with distributed load.

PERFECT CORRECTION
 CORRECCIÓN PERFECTA

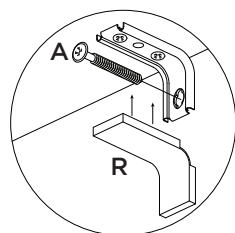
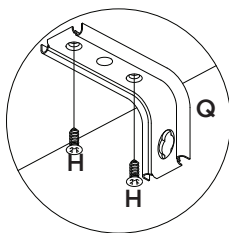
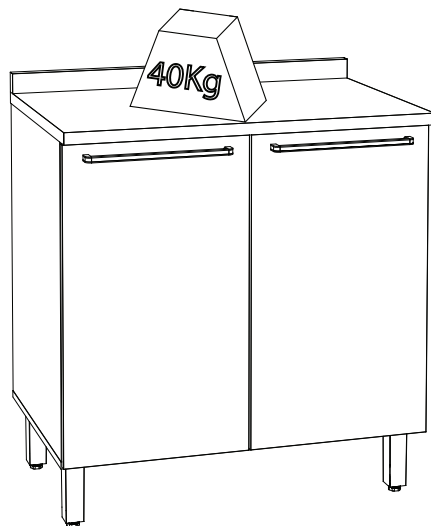
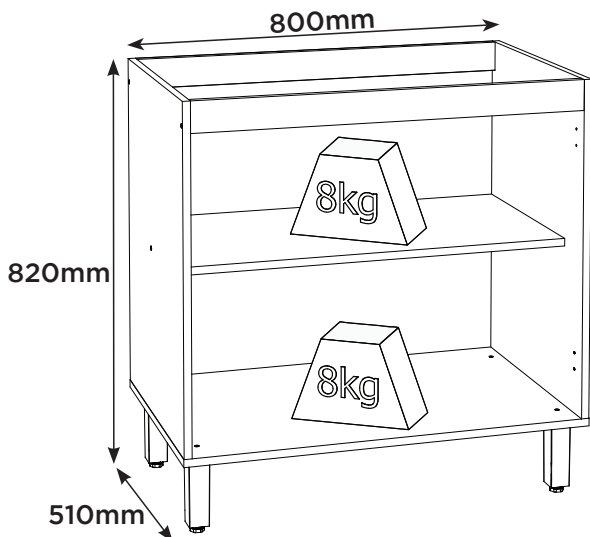
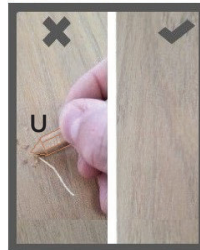

RECOMENDAÇÃO

Para fixar o móvel na parede usar o suporte de fixação (Q), o parafuso 4,0x14mm CHT (H), a Bucha 8mm (P) e o parafuso 5,0x50mm FLA (A).

RECOMENDACIÓN

Para conectar el móvil a la pared con el soporte (Q), tornillo 4,0x14mm CHT (H), el casquillo de 8 mm (P) y el 5,0 x50mm tornillo FLA (A).

RECOMMENDATION

To fix the furniture to the wall use the fixing bracket (Q), the 4,0x14mm CHT (H) screw, the 8mm bushing (P) and the 5.0x50mm FLA screw (A).

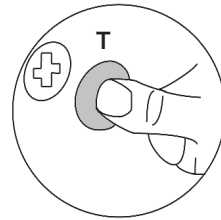
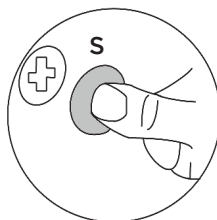

Produto Concluído
Producto terminado
Finished Product

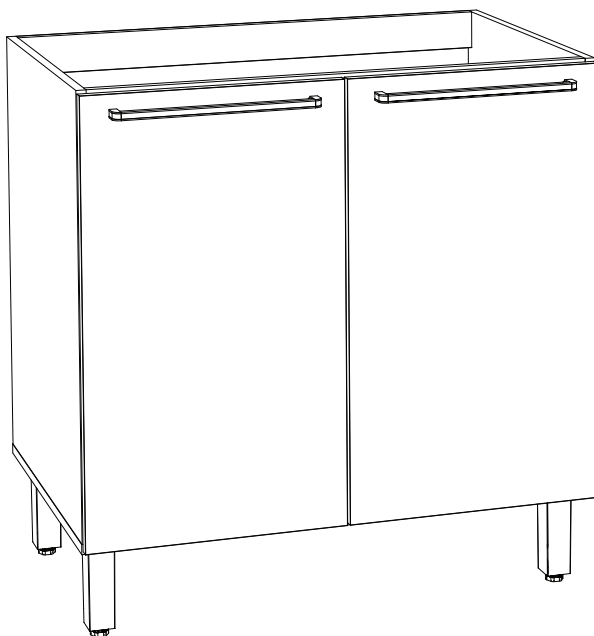

HENNInd. e Com. de Móveis Henn
Mondai - SC - Brasil

☎ +55 49 3674.3500

📧 @moveishenn
www.henn.com.br**INSTRUÇÕES DE
MONTAGEM**INSTRUCCIONES DE MONTAJE
ASSEMBLY INSTRUCTIONS**Balcão Pia 02 Gavetas 03 Portas Requinte |**
Pia Contador 02 Cajones 03 Puertas Requinte |
Balcony Pia 02 Drawers 03 Doors Requinte

C640-217 Nature/Areia

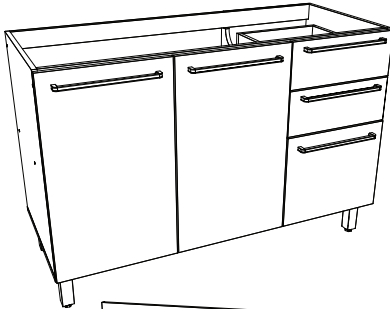
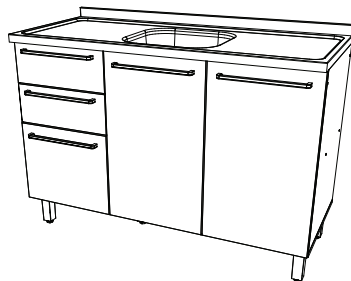
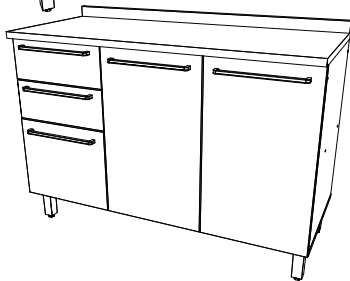
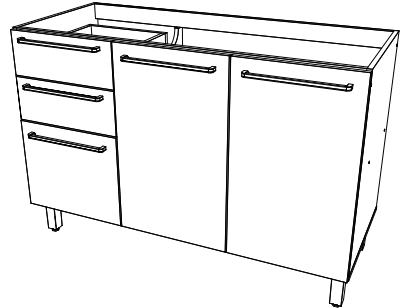
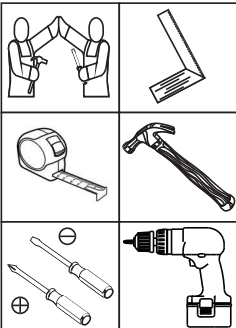
Opção 01
Opción 01
Option 01Opção 02
Opción 02
Option 02Requisitos para montagem
Requisitos para la montaje
Assembly RequirementsImagens meramente ilustrativas,
não acompanha o produto.
Imágenes ilustrativas, no incluidas
con el producto.
Illustrative images, not included
with the product.**AVISO**

Para limpeza de seu móvel, use uma flanela seca ou umedecida, e não utilize produtos químicos que possam danificar seu produto.

SISTEMA DE MONTAGEM

O sistema de montagem dos produtos, funciona de acordo com a ordem crescente dos números indicados no desenho. Ex: 01, 02, 03, 04... até a conclusão da montagem.

ASSISTÊNCIA TÉCNICA

Para solicitação de Assistência Técnica você consumidor deverá entrar em contato com o Lojista a qual você realizou a compra deste produto e solicitar a assistência técnica das peças avariadas. A garantia abrange todas as peças, partes e componentes que eventualmente venham apresentar defeito de fabricação no prazo de 03 (três) meses, contando a partir da entrega do produto ao consumidor, mediante nota fiscal de compra. Se houver qualquer alteração na estrutura do produto ou ocorrer defeito por negligência do montador/consumidor em relação a instrução de montagem e manuseio, não será fornecido assistência técnica gratuita.

ADVERTENCIA

Para limpieza de su móvil, use una flanela seca o húmeda, y no utilice productos químicos que puedan dañar su producto.

SISTEMA DE MONTAJE

El sistema de montaje de los productos funciona de acuerdo con el orden creciente de los números indicados en el dibujo. Ej.: 01, 02, 03, 04... hasta la conclusión del montaje.

ASISTENCIA TÉCNICA

Para solicitar Asistencia Técnica, el consumidor debe comunicarse con el Comercio que usted realizó la compra de este producto y solicita asistencia técnica para las partes dañadas. La garantía cubre todas las partes, piezas y componentes que eventualmente puedan presentar defecto de fabricación en el plazo de 03 (tres) meses, contados a partir de la entrega del producto al consumidor, mediante factura de compra. Si se produce algún cambio en la estructura del producto o se produce un defecto por negligencia del montador/consumidor en relación con las instrucciones de montaje y manipulación, no se prestará asistencia técnica gratuita.

NOTICE

To clean your furniture, use a dry or wet cloth, and do not use chemicals that may damage your product.

ASSEMBLY SYSTEM

The products' assembly system works according to the increasing order of the indicated numbers. For example: 01, 02, 03, 04 ... to the end of the assembly.

TECHNICAL ASSISTANCE

To request Technical Assistance, the consumer must contact the retailer from whom you purchased this product and request technical assistance for the damaged parts. The warranty covers all parts, parts and components that may eventually present a manufacturing defect within a period of 03 (three) months, counting from the delivery of the product to the consumer, by means of a purchase invoice. If there is any change in the structure of the product or defect occurs due to negligence of the assembler/consumer in relation to the assembly and handling instruction, free technical assistance will not be provided.

ACESSÓRIOS | ACCESORIOS | ACCESSORIES

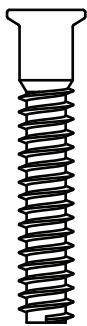

x5

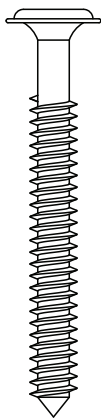

x2



x4



x2



x14

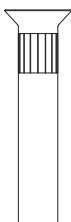

x6

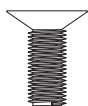

x6

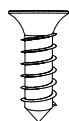

x98



x4



x10

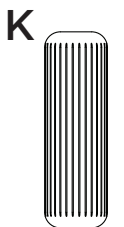

x32



x38



x13



Os parafusos (F/G) devem ser usados somente quando este módulo for acoplado a outro módulo componível Henn.



Los tornillos (F/G) se debe utilizar sólo cuando el módulo está conectado a otro módulo componible Henn.



Screws (F/G) are to be used only when this module is mated to another Henn buildable module.

Parafusos em escala
Tornillos escalados
Scaled screws **1:1**

ACESSÓRIOS | ACCESORIOS | ACCESSORIES

N

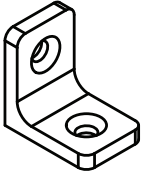

x11

O

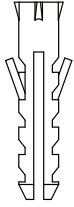

x2

P

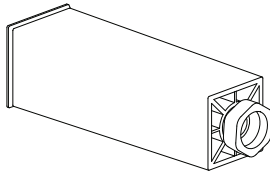

x5

Q

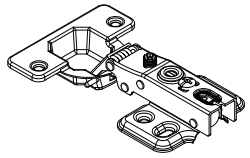

x6

R

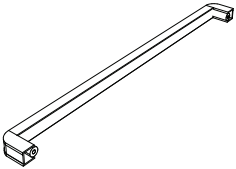

x5

S

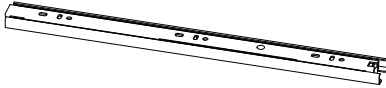

x2

T

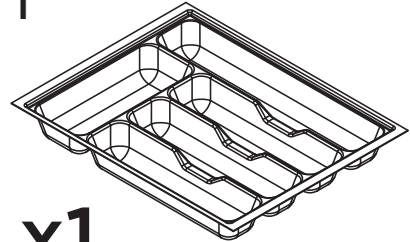

x1

U

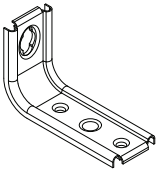

x2

V

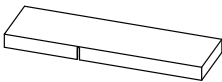

x2

W

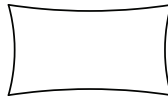

x2

X

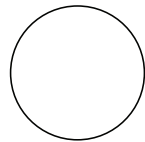

x6

Y



x26

Z

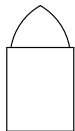

x3

AA



x1

LISTA DE PEÇAS | LISTA DE PIEZAS | LIST OF PIECES

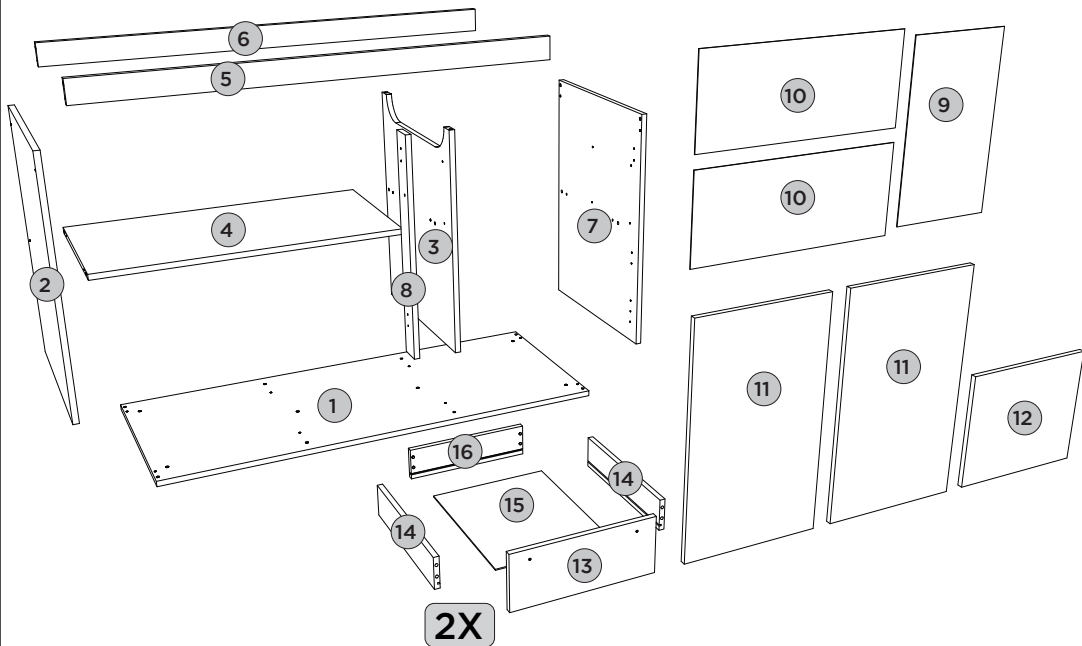

Item	Caixa Caja Box	Qty Ctd Qty	Descrição Descripción Description	Dimensões (mm) Dimensiones (mm)		
				Comprimento Largo Length	Largura Ancho Width	Espessura Grosor Thickness
1	1/1	01	BASE BASE BASE	1200	490	15
2	1/1	01	LATERAL ESQUERDA LATERAL IZQUIERDA LEFT SIDE	660	490	15
3	1/1	01	DIVISÃO DIVISIÓN DIVISION	600	490	15
4	1/1	01	PRATELEIRA ESTANTE SHELF	783	400	15
5	1/1	01	TRAVESSA FRONTAL TRAVESAÑO FRONTAL FRONT CROSSBAR	1168	60	15
6	1/1	01	TRAVESSA TRASEIRA TRAVESAÑO TRASERO REAR BUMPER	1168	60	15
7	1/1	01	LATERAL DIREITA LATERAL DERECHA RIGHT SIDE	660	490	15
8	1/1	01	PILASTRA DA PORTA PILASTRA PUERTA PILASTER DOOR	597	60	15
9	1/1	01	FUNDO MENOR FONDO MENOR MINOR FUND	672	389	3
10	1/1	02	FUNDO FONDO BOTTOM	802	335	3
11	1/1	02	PORTA PUERTA DOOR	665	396	15
12	1/1	01	PORTA MENOR PUERTA MENOR SMALLER DOOR	396	337	15
13	1/1	02	FRENTE DE GAVETA FRENTE DE CAJÓN FRONT OF DRAWER	396	160	15
14	1/1	04	LADO DE GAVETA MENOR LADO DEL CAJÓN MENOR SMALLEST DRAWER SIDE	400	90	15
15	1/1	02	FUNDO DE GAVETA FONDO DE CAJÓN BOTTOM OF DRAWER	411	326	3
16	1/1	02	RIPA DE TRÁS MALLA DETRÁS REAR LATH	345	90	15





PASSO 1

ITM/C640-

PEÇAS REQUERIDAS

1	BASE	x1
4	PRATELEIRA	x1
5	TRAVESSA FRONTAL	x1
6	TRAVESSA TRASEIRA	x1

ACESSÓRIOS REQUERIDOS

A		05
K		08
P		05
W		

FERRAMENTAS NECESSÁRIAS

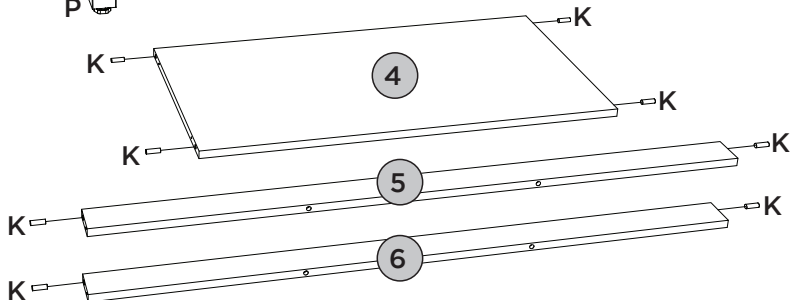
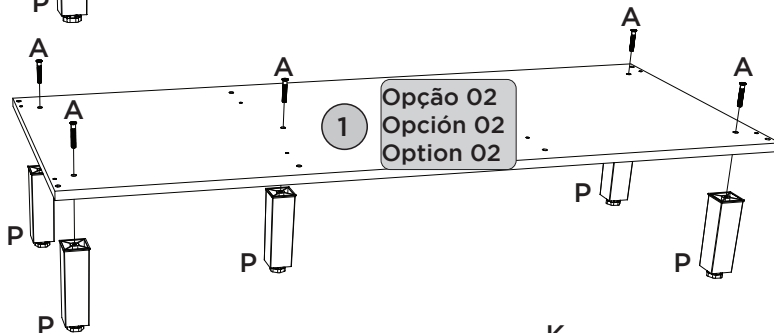
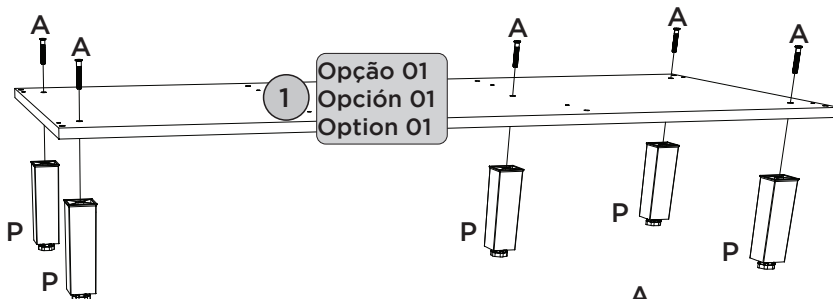
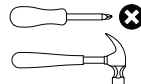

Utilizar o sachê de cola (W) em todas as cavilhas (K) do produto.

Con el pegamento sobre (W) en todos los pernos (K) producto.

Use the glue sachet (W) on all the pegs (K) of the product.

PASSO 2

ITM/C640-

PEÇAS REQUERIDAS

2	LATERAL ESQUERDA	x1
3	DIVISÃO	x1
7	LATERAL DIREITA	x1

ACESSÓRIOS REQUERIDOS

H		12
K		08
S		04
W		

FERRAMENTAS NECESSÁRIAS

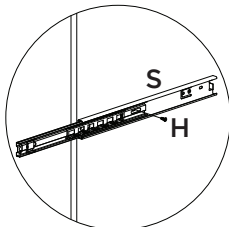
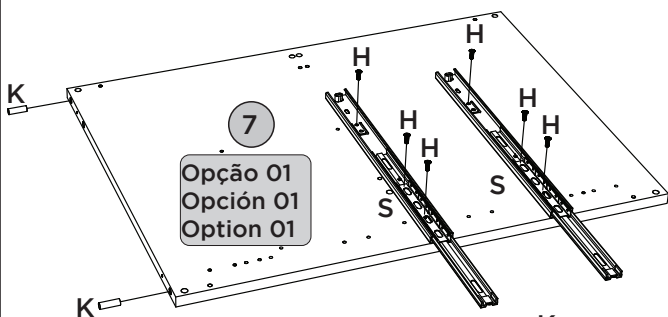
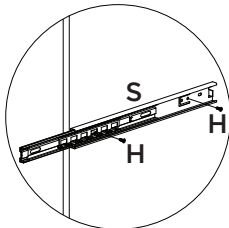
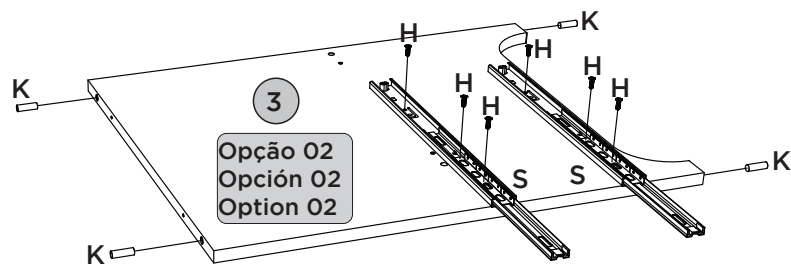
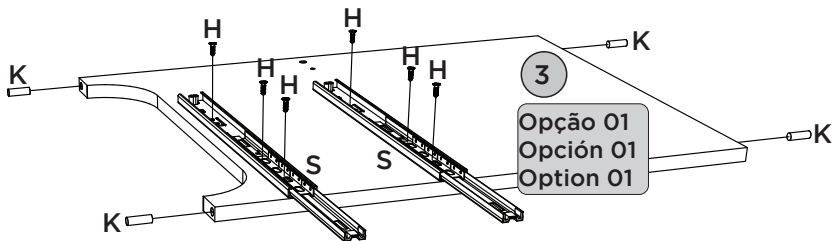
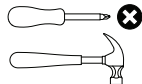

Na Opção 01 a Lateral Esquerda (02) ficará apenas com cavilhas (K), assim como na opção 02 a Lateral Direita (07) ficará apenas com cavilhas (K).



En la Opción 01 el Lado Izquierdo (02) solo tendrá pasadores (K), al igual que en la opción 02 el Lado Derecho (07) solo tendrá pasadores (K).

In Option 01 the Left Side (02) will only have pins (K), just as in option 02 the Right Side (07) will only have pins (K).

PEÇAS REQUERIDAS

1	BASE	x1
2	LATERAL ESQUERDA	x1
3	DIVISÃO	x1
4	PRATELEIRA	x1
5	TRAVESSA FRONTAL	x1
6	TRAVESSA TRASEIRA	x1
7	LATERAL DIREITA	x1

ACESSÓRIOS REQUERIDOS

E		10
W		

FERRAMENTAS NECESSÁRIAS

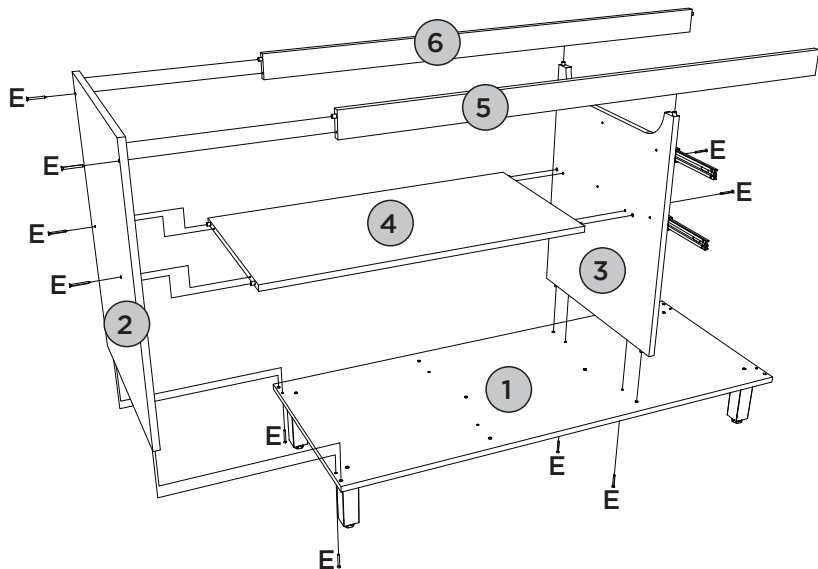
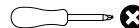

Opção 01
Opción 01
Option 01



Opção 02
Opción 02
Option 02

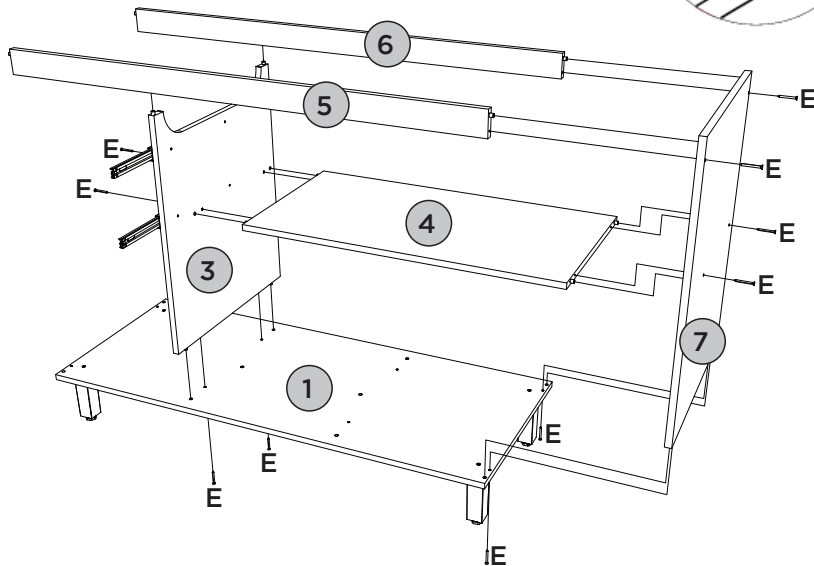





PASSO 4

ITM/C640-

PEÇAS REQUERIDAS

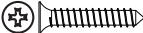
2	LATERAL ESQUERDA	x1
7	LATERAL DIREITA	x1
8	PILASTRA DA PORTA	x1

ACESSÓRIOS REQUERIDOS

D		02
E		04
H		02
N		01
W		

FERRAMENTAS NECESSÁRIAS

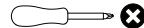



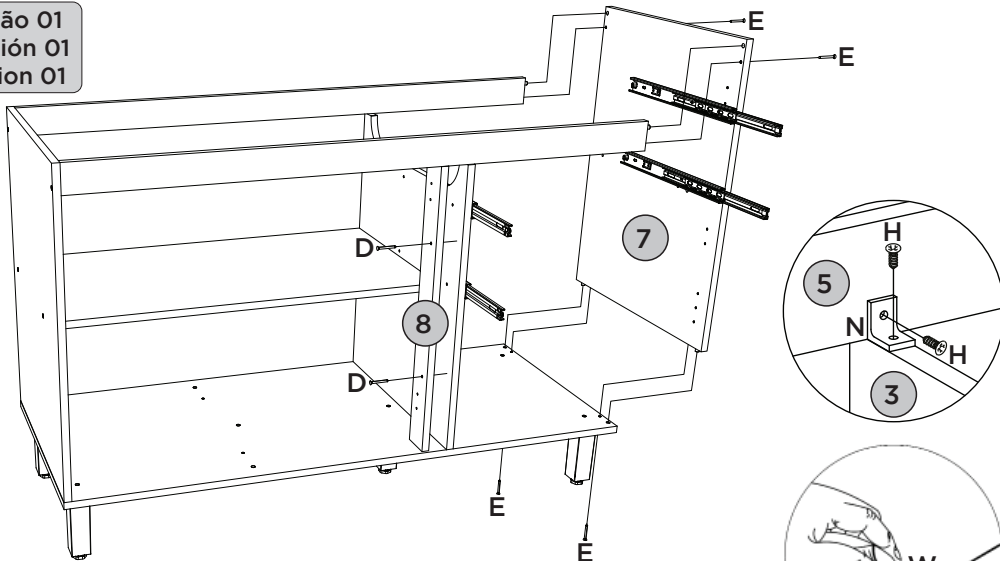

Opção 01
Opción 01
Option 01

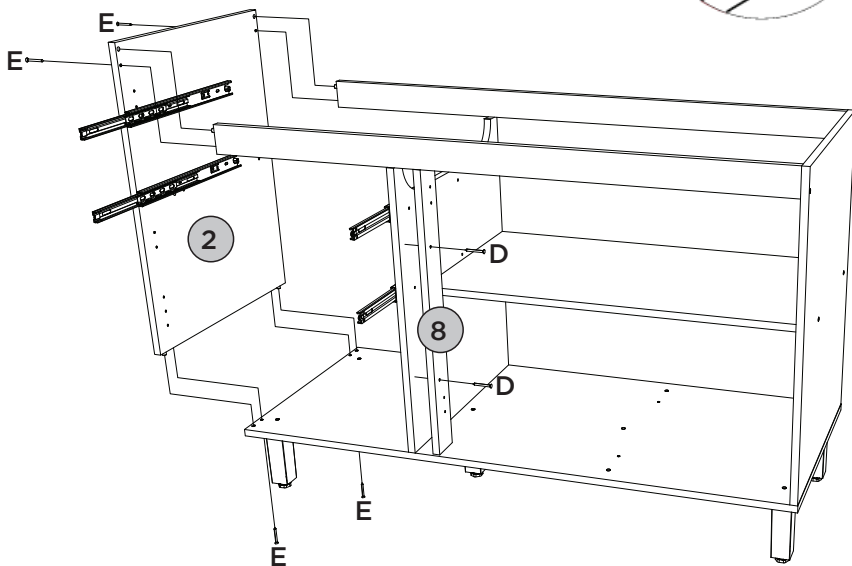

Opção 02
Opción 02
Option 02



ACESSÓRIOS REQUERIDOS

C			04
H			12
N			06

FERRAMENTAS NECESSÁRIAS

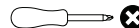

Esse tampo é opcional e é vendido separadamente (C905-128).

Esta vez es opcional y se vende por separado (C905-128).

This top is optional and is sold separately (C905-128).

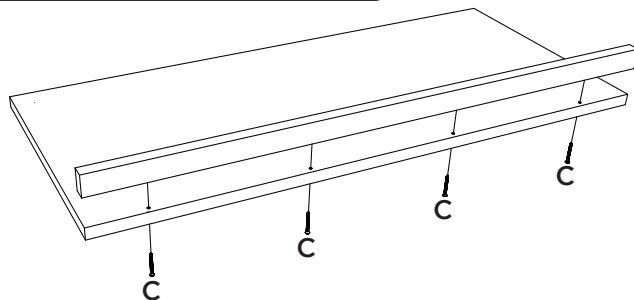

Opção 01
Opción 01
Option 01

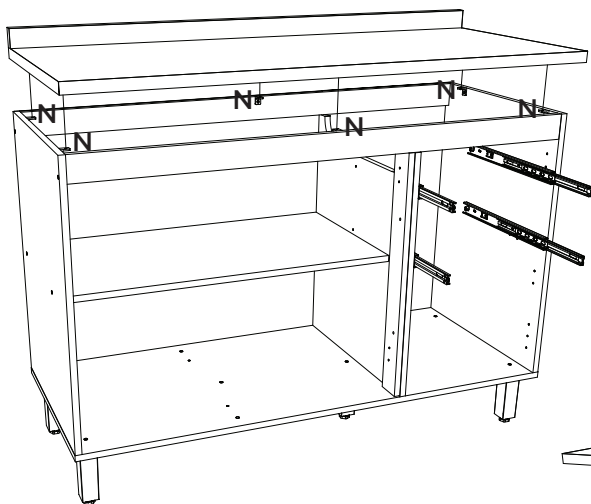

Opção 02
Opción 02
Option 02

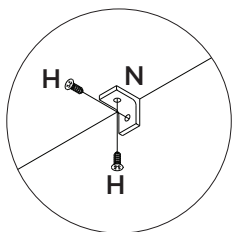
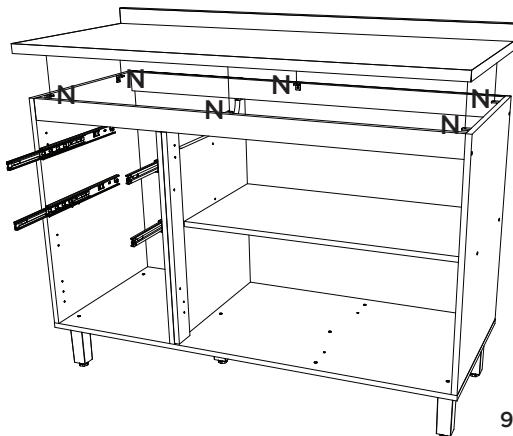



PASSO 6

ITM/C640-

PEÇAS REQUERIDAS

9	FUNDO MENOR	x1
10	FUNDO	x2

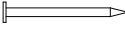
ACESSÓRIOS REQUERIDOS

H		12
L		38
M		13

FERRAMENTAS NECESSÁRIAS

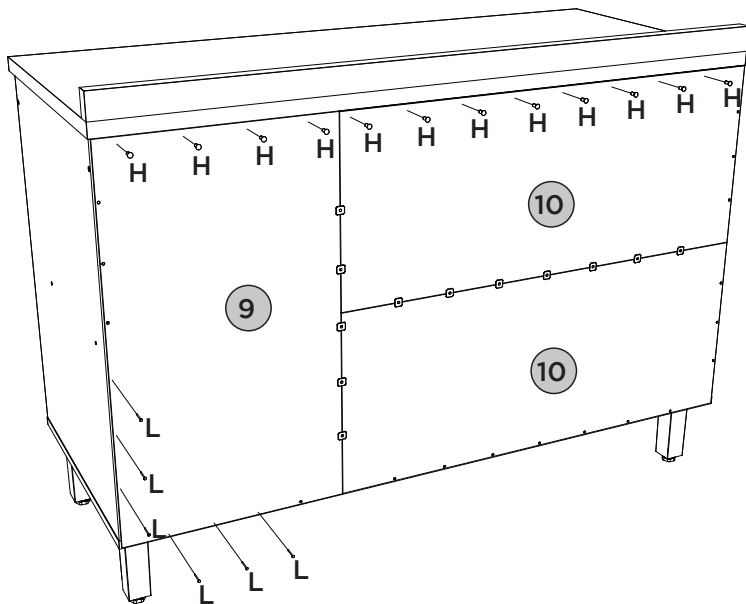
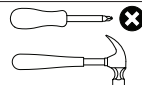

Opção 01
Opción 01
Option 01

Opção 02
Opción 02
Option 02

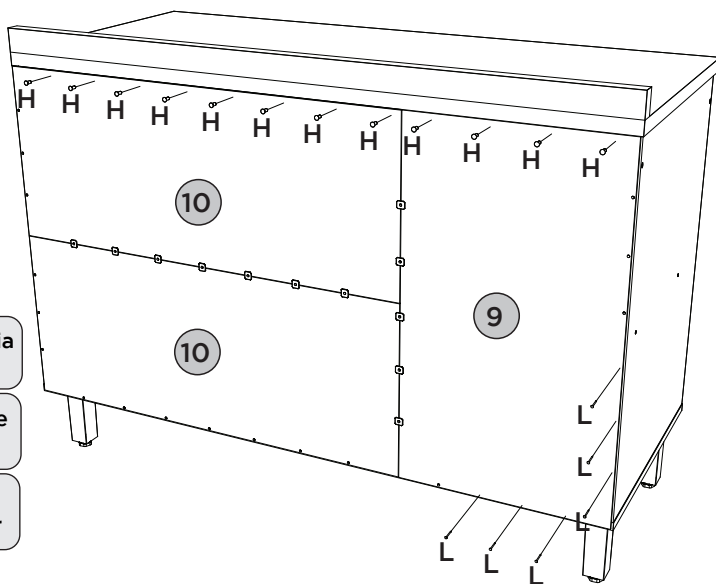

Fixar os pregos a uma distância de 100mm de um para outro.



Fijar las uñas a un distancia de 100mm uno a otro.

Fix the nails at a distance of 100mm from one to the other

PEÇAS REQUERIDAS

11	PORTA	x2
12	PORTA MENOR	x1

ACESSÓRIOS REQUERIDOS

H		12
Q		06

FERRAMENTAS NECESSÁRIAS

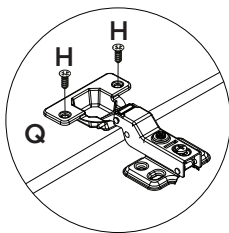
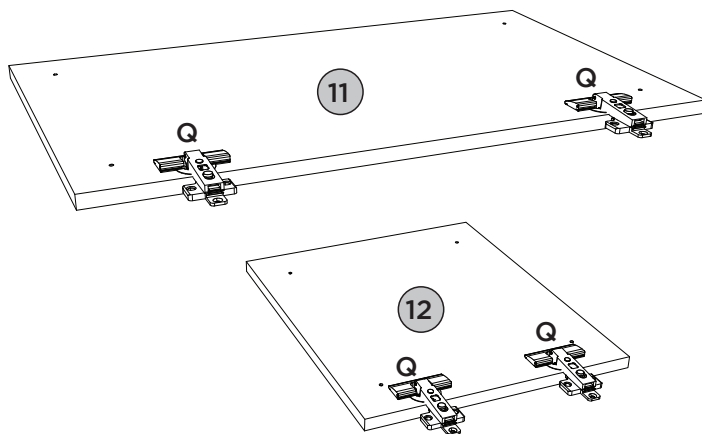
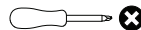



PASSO 8

ITM/C640-

PEÇAS REQUERIDAS

11	PORTA	x2
12	PORTA MENOR	x1

ACESSÓRIOS REQUERIDOS

H		24
J		06
R		03

FERRAMENTAS NECESSÁRIAS



Para porta (11 e 12): Defina para o modo de perfuração.
Faça a furação passante para fixar os puxadores (R).

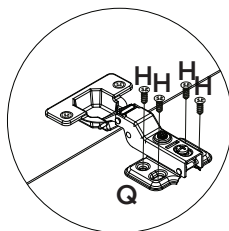
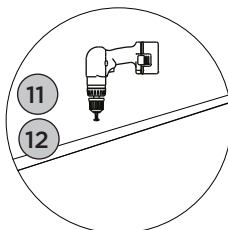
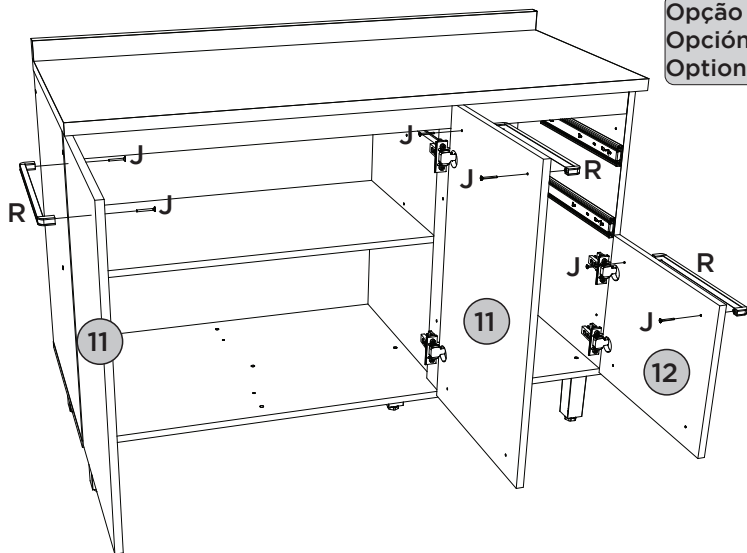

Opção 02
Opción 02
Option 02

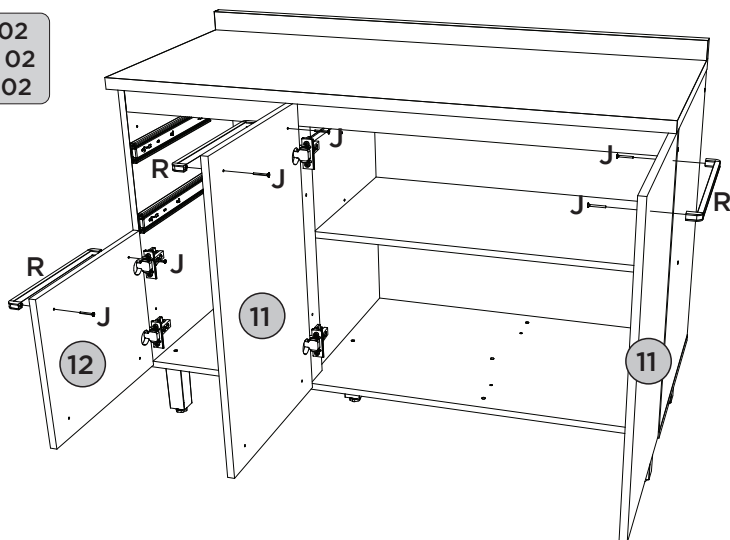





PASSO 9

ITM/C640-

PEÇAS REQUERIDAS

13	FRENTE DE GAVETA	x2
14	LADO DE GAVETA	x4
15	FUNDO DE GAVETA	x2

ACESSÓRIOS REQUERIDOS

H		08
K		16
N		04
W		

FERRAMENTAS NECESSÁRIAS

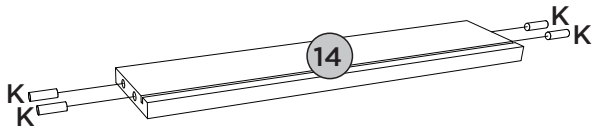
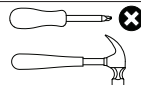

1º
2X

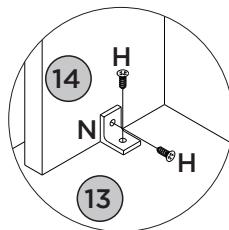
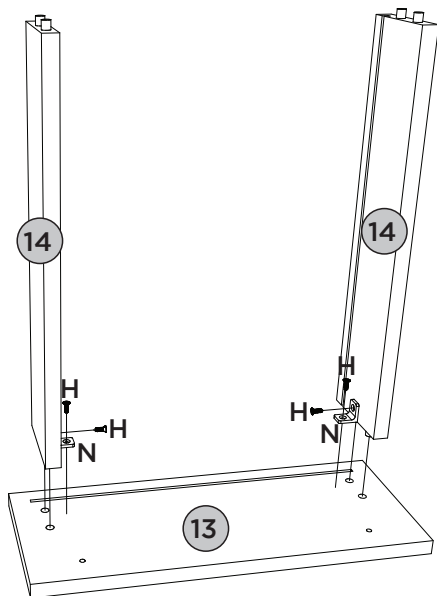

2º
2X

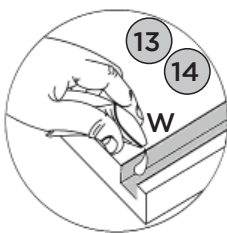
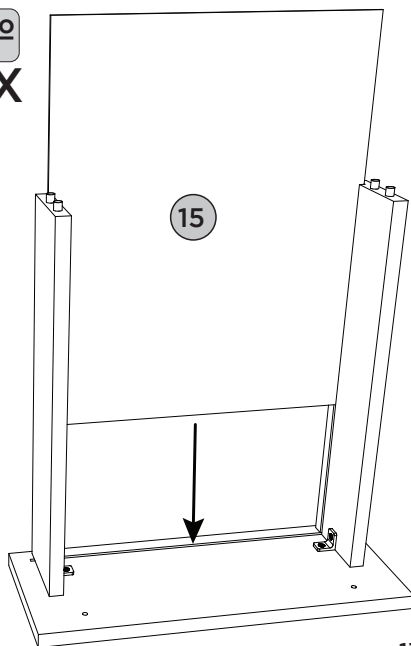

PASSO 10

ITM/C640-

PEÇAS REQUERIDAS

16	RIPA DE TRÁS	x2
----	--------------	----

ACESSÓRIOS REQUERIDOS

H		12
I		04
J		04
R		02
S		04
W		

FERRAMENTAS NECESSÁRIAS

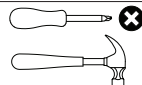

3º
2X

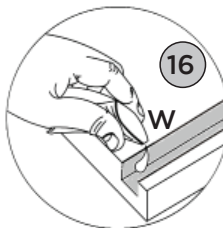
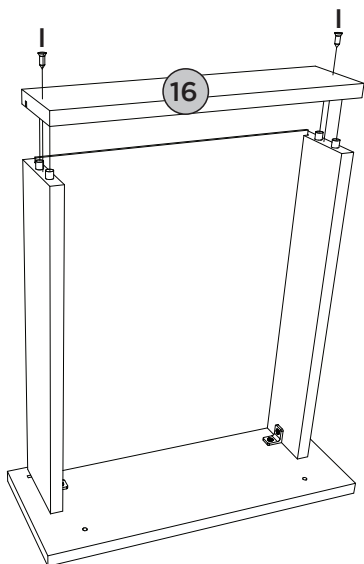

4º
2X

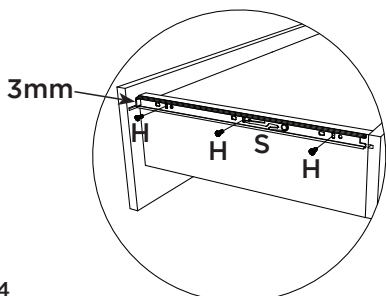
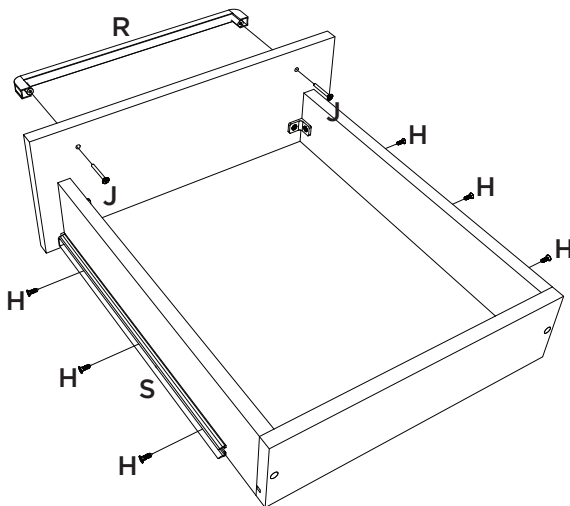

ACESSÓRIOS REQUERIDOS

B		02	X		06
H		04	Y		26
O		02	Z		03
U		02	AA		01
V		02			

FERRAMENTAS NECESSÁRIAS



OU

Para parede: Ajustar no modo perfuração.
Para peça (02 e 07): Usar torque 5.

Pesos máximos recomendados com carga distribuída
Peso máximo recomendado con la carga distribuida
Recommended maximum weight with distributed load.

PERFECT CORRECTION
CORRECCIÓN PERFECTA

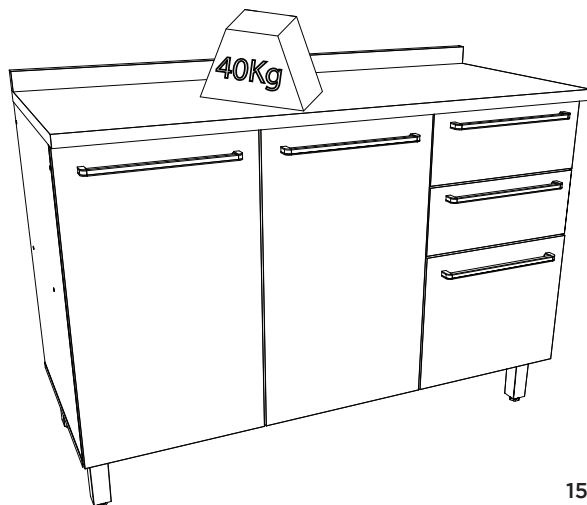
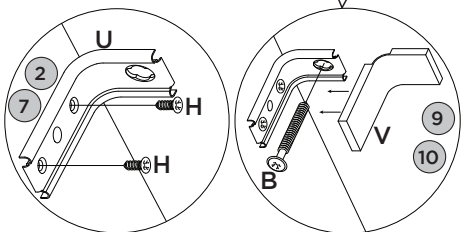
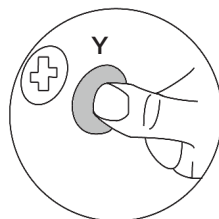
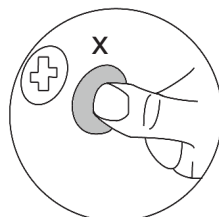
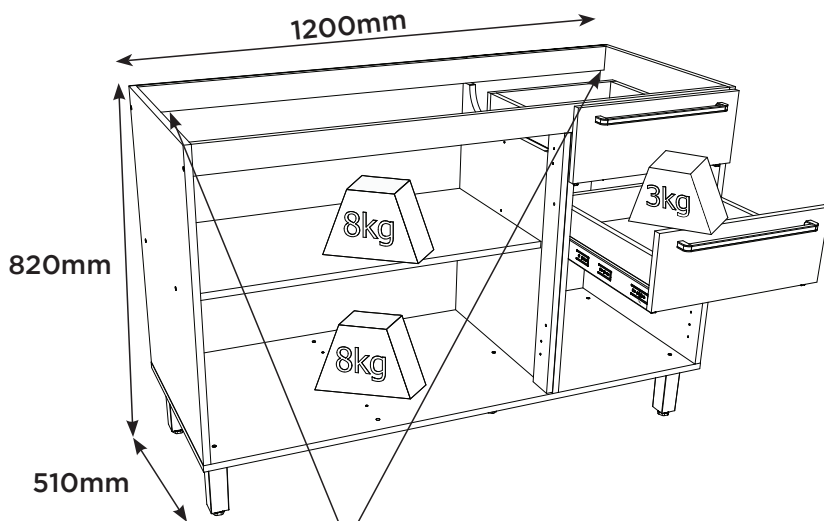
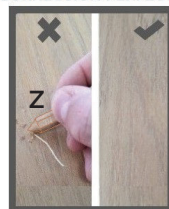

RECOMENDAÇÃO

Para fixar o móvel na parede usar o suporte de fixação (U), o parafuso 4,0x14mm CHT (H), a Bucha 8mm (O) e o parafuso 5,0x50mm FLA (B).

RECOMENDACIÓN

Para conectar el móvil a la pared con el soporte (U), tornillo 4,0 x14mm CHT (H), el casquillo de 8 mm (O) y el 5,0 x50mm tornillo FLA (B).

RECOMMENDATION

To fix the furniture to the wall use the fixing bracket (U), the 4,0x14mm CHT (H) screw, the 8mm bushing (O) and the 5.0x50mm FLA screw (B).

Producto Concluído
Producto terminado
Finished Product

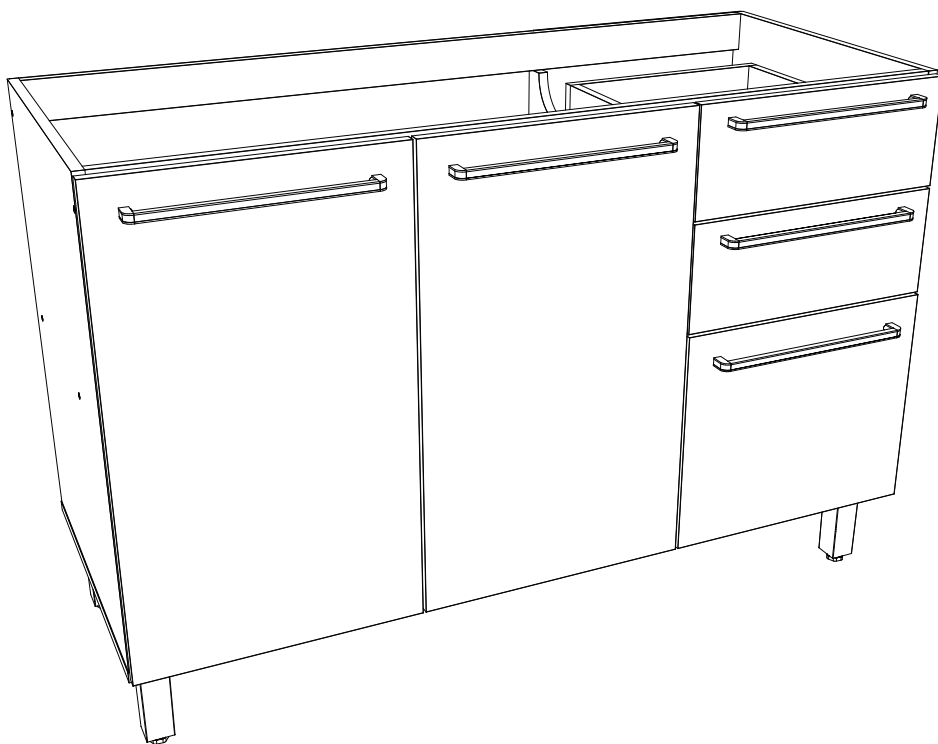

HENNInd. e Com. de Móveis Henn
Mondai - SC - Brasil

☎ +55 49 3674.3500

📱 @moveishenn
www.henn.com.br**INSTRUÇÕES DE
MONTAGEM**INSTRUCCIONES DE MONTAJE
ASSEMBLY INSTRUCTIONS**Balcão Canto Reto 01 Porta Requinte | Balcón de
Esquina Reto 01 Puerta Requinte | Balcony Corner Straight 01
Door Requinte**

C641-217 Nature/Areia HP

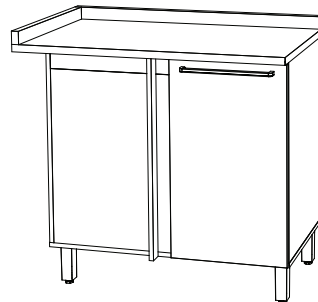
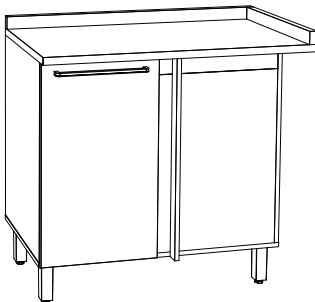
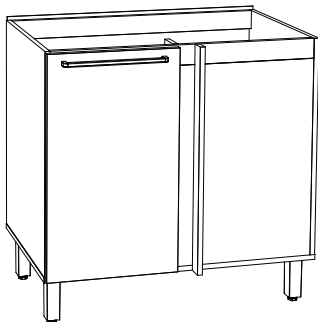
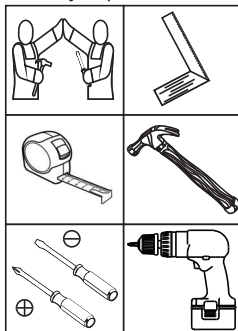
**Opção 01
Opción 01
Option 01****Opção 02
Opción 02
Option 02****Requisitos para montagem
Requisitos para la montaje
Assembly Requirements**

Imagens meramente ilustrativas,
não acompanha o produto.
Imágenes ilustrativas, no incluidas
con el producto.
Illustrative images, not included
with the product.

AVISO

Para limpeza de seu móvel, use uma franela seca ou umedecida, e não utilize produtos químicos que possam danificar seu produto.

SISTEMA DE MONTAGEM

O sistema de montagem dos produtos, funciona de acordo com a ordem crescente dos números indicados no desenho. Ex: 01, 02, 03, 04... até a conclusão da montagem.

ASSISTÊNCIA TÉCNICA

Para solicitação de Assistência Técnica você consumidor deverá entrar em contato com o Lojista o qual você realizou a compra deste produto e solicitar a assistência técnica das peças avariadas. A garantia abrange todas as peças, partes e componentes que eventualmente venham apresentar defeito de fabricação no prazo de 03 (três) meses, contando a partir da entrega do produto ao consumidor, mediante nota fiscal de compra. Se houver qualquer alteração na estrutura do produto ou ocorrer defeito por negligência do montador/consumidor em relação a instrução de montagem e manuseio, não será fornecido assistência técnica gratuita.

ADVERTENCIA

Para limpieza de su móvil, use una franela seca o húmeda, y no utilice productos químicos que puedan dañar su producto.

SISTEMA DE MONTAJE

El sistema de montaje de los productos funciona de acuerdo con el orden creciente de los números indicados en el dibujo. Ej.: 01, 02, 03, 04... hasta la conclusión del montaje.

ASISTENCIA TÉCNICA

Para solicitar Asistencia Técnica, el consumidor debe comunicarse con el Comercio que usted realizó la compra de este producto y solicita asistencia técnica para las partes dañadas. La garantía cubre todas las partes, piezas y componentes que eventualmente puedan presentar defecto de fabricación en el plazo de 03 (tres) meses, contados a partir de la entrega del producto al consumidor, mediante factura de compra. Si se produce algún cambio en la estructura del producto o se produce un defecto por negligencia del montador/consumidor en relación con las instrucciones de montaje y manipulación, no se prestará asistencia técnica gratuita.

NOTICE

To clean your furniture, use a dry or wet cloth, and do not use chemicals that may damage your product.

ASSEMBLY SYSTEM

The products' assembly system works according to the increasing order of the indicated numbers. For example: 01, 02, 03, 04 ... to the end of the assembly.

TECHNICAL ASSISTANCE

To request Technical Assistance, the consumer must contact the retailer from whom you purchased this product and request technical assistance for the damaged parts. The warranty covers all parts, parts and components that may eventually present a manufacturing defect within a period of 03 (three) months, counting from the delivery of the product to the consumer, by means of a purchase invoice. If there is any change in the structure of the product or defect occurs due to negligence of the assembler/consumer in relation to the assembly and handling instruction, free technical assistance will not be provided.

ACESSÓRIOS | ACCESORIOS | ACCESSORIES

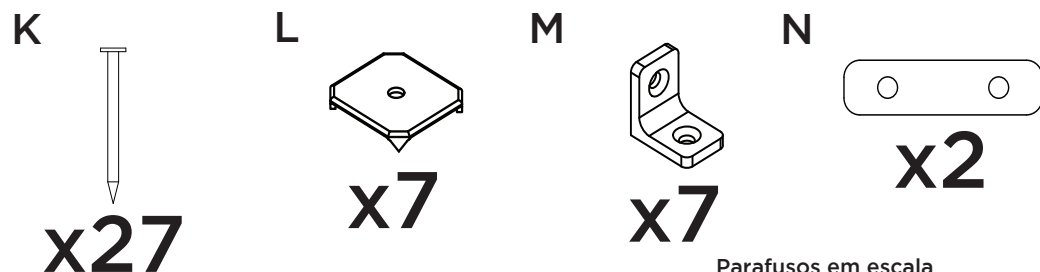
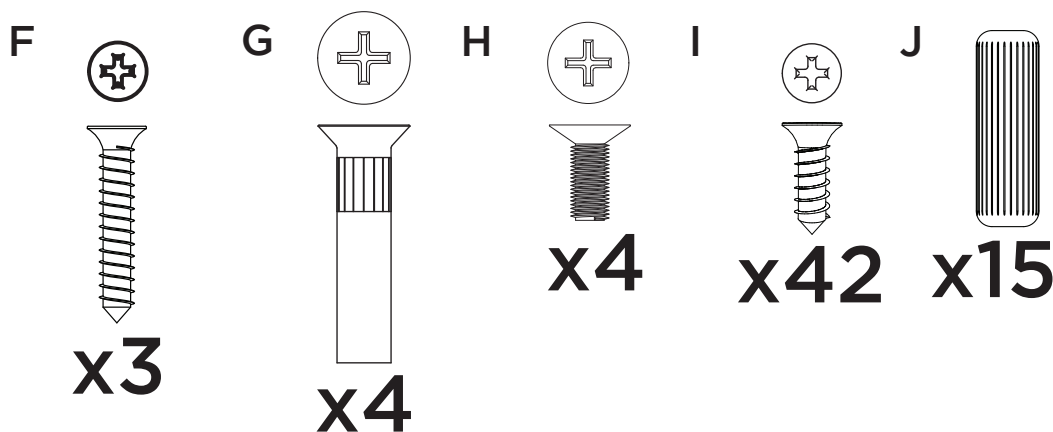
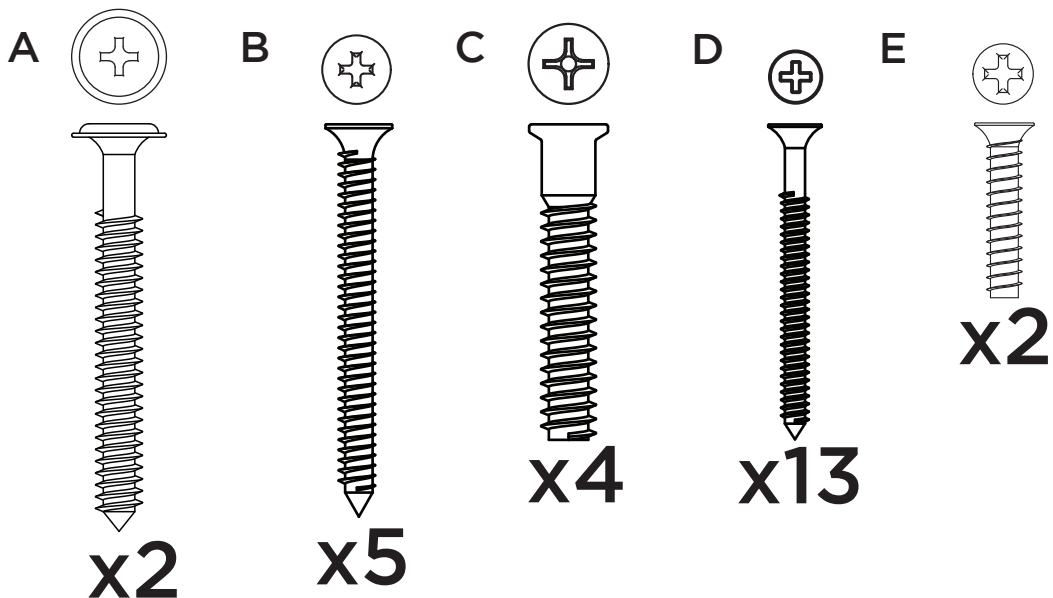

Parafusos em escala
Tornillos escalados
Scaled screws **1:1**

ACESSÓRIOS | ACCESORIOS | ACCESSORIES

O

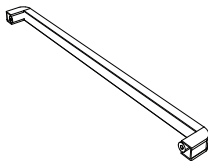

x1

P

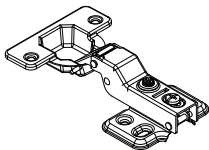

x2

Q

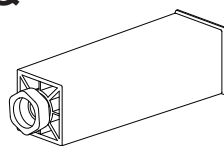

x4

R



x2

S

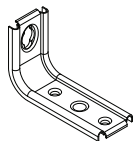

x2

T

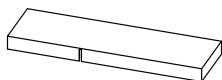

x2

U

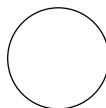

x12

V

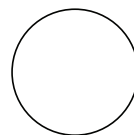

x4

W

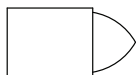

x3

X

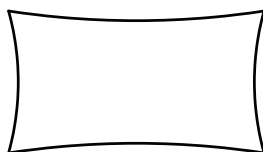

x2

Y



x1



Os parafusos (G/H) devem ser usados somente quando este módulo for acoplado a outro módulo componível Henn.



Los tornillos (G/H) se debe utilizar sólo cuando el módulo está conectado a otro módulo componible Henn.



Screws (G/H) are to be used only when this module is mated to another Henn buildable module.

LISTA DE PEÇAS | LISTA DE PIEZAS | LIST OF PIECES

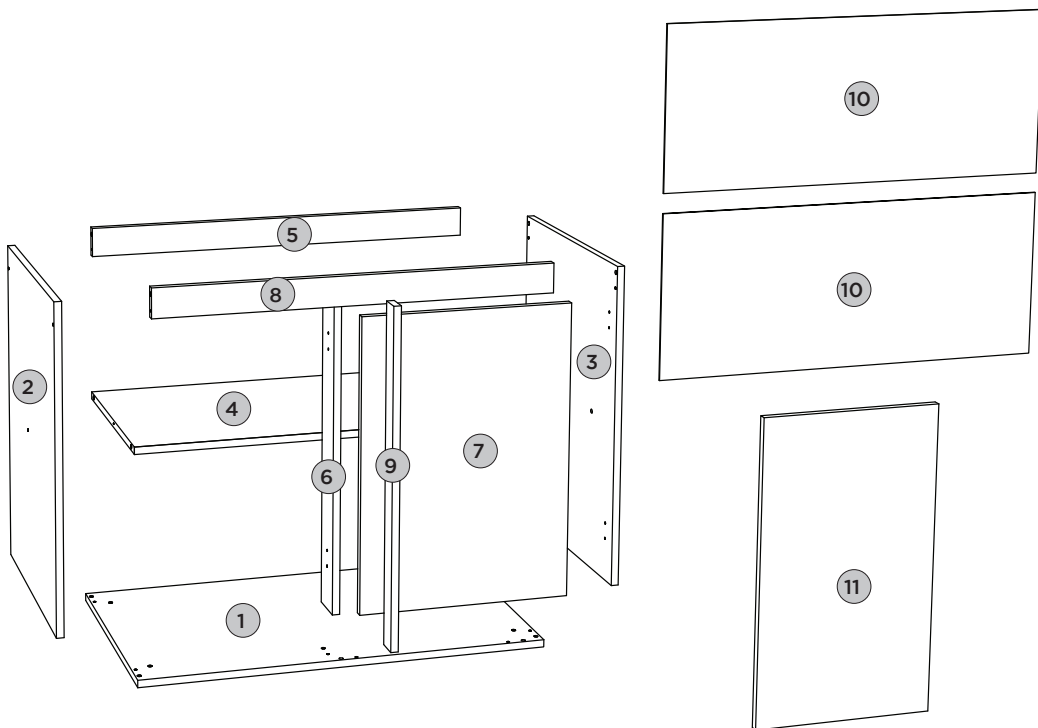

Item	Caixa Caja Box	Qty Ctd Qty	Descrição Descripción Description	Dimensões (mm) Dimensiones (mm) Dimensions (mm)		
				Comprimento Largo Length	Largura Ancho Width	Espessura Grosor Thickness
1	1/1	01	BASE BASE BASE	840	490	15
2	1/1	01	LATERAL ESQUERDA LATERAL IZQUIERDA LEFT SIDE	660	490	15
3	1/1	01	LATERAL DIREITA LATERAL DERECHA RIGHT SIDE	660	490	15
4	1/1	01	PRATEIRA ESTANTE SHELF	808	400	15
5	1/1	01	TRAVESSA TRASEIRA TRAVESAÑO TRASERO REAR BUMPER	808	60	15
6	1/1	01	PILASTRA DA PORTA PUERTA PILASTRA DOOR PILASTER	660	75	15
7	1/1	01	FRENTE FIXA FRENTE FIJA FIXED FRONT	600	435	15
8	1/1	01	TRAVESSA FRONTAL TRAVESAÑO FRONTAL FRONT CROSSBAR	808	60	15
9	1/1	01	TRAVESSA ESTRUTURAL TRAVESAÑO ESTRUCTURAL STRUCTURAL CROSSBEAM	675	43	15
10	1/1	02	FUNDO FONDO BOTTOM	832	341	3
11	1/1	01	PORTA PUERTA DOOR	665	396	15



PASSO 1

ITM/C641-

PEÇAS REQUERIDAS

1	BASE	x1
2	LATERAL ESQUERDA	x1
3	LATERAL DIREITA	x1
4	PRATELEIRA	x1
5	TRAVESSA TRASEIRA	x1
6	PILASTRA DA PORTA	x1
7	FRENTE FIXA	x1
8	FRONTAL FRONTAL	x1

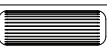
ACESSÓRIOS REQUERIDOS

C		04
J		15
Q		04
X		

FERRAMENTAS NECESSÁRIAS

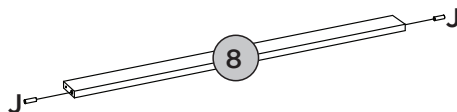
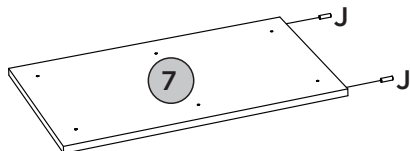
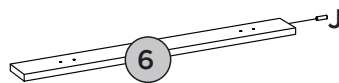
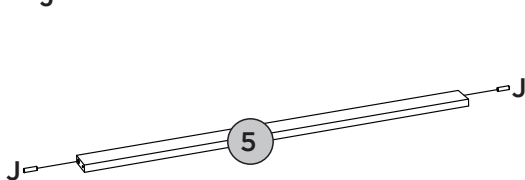
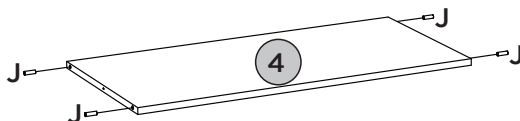
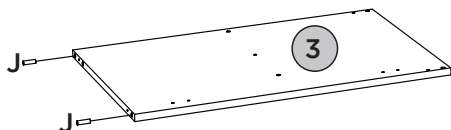
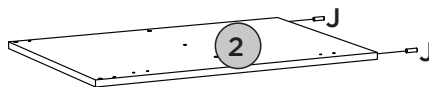
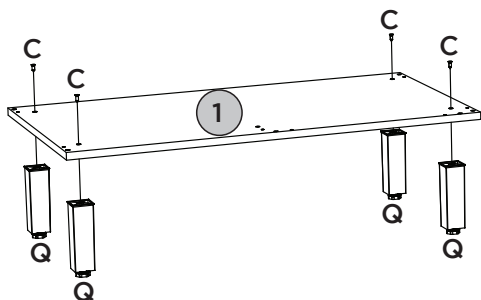
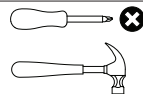

Utilizar o sachê de cola (X) em todas as cavilhas (J) do produto.



Con el pegamento sobre (X) en todos los pernos (J) producto.

Use the glue sachet (X) on all the pegs (J) of the product.

PASSO 2**PEÇAS REQUERIDAS**

1	BASE	x1
2	LATERAL ESQUERDA	x1
3	LATERAL DIREITA	x1
4	PRATELEIRA	x1
5	PILASTRA DA PORTA	x1
6	TRAVESSA TRASEIRA	x1
7	FRENTE FIXA	x1
8	TRAVESSA FRONTAL	x1

ACESSÓRIOS REQUERIDOS

D			13
X			

FERRAMENTAS NECESSÁRIAS

Opção 01
Opción 01
Option 01

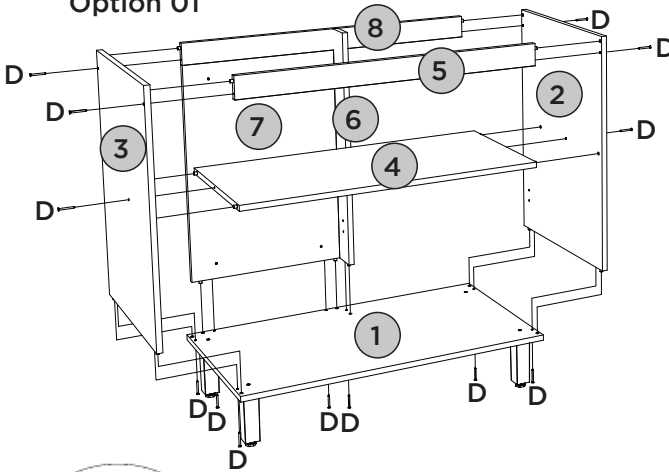

VISTA TRASEIRA

VISTA TRASERA

BACK VIEW

Opção 02
Opción 02
Option 02

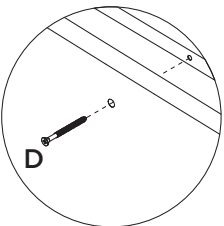
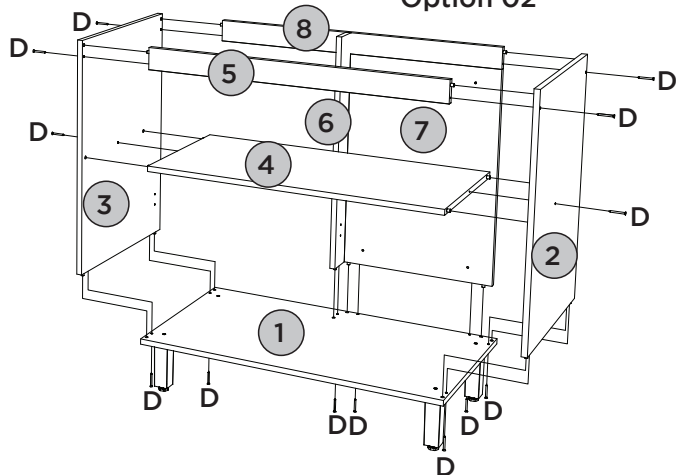

PASSO 3

ITM/C641-

PEÇAS REQUERIDAS

9	TRAVESSA ESTRUTURAL	x1
---	---------------------	----

ACESSÓRIOS REQUERIDOS

F			03
I			10
M			03
N			02

FERRAMENTAS NECESSÁRIAS

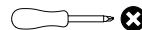

Opção 01
Opción 01
Option 01

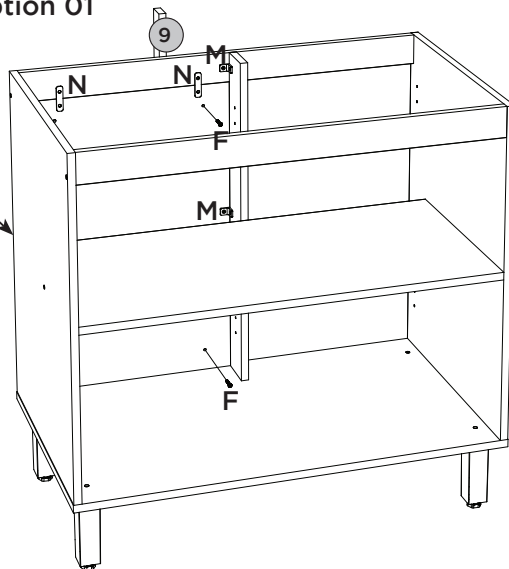
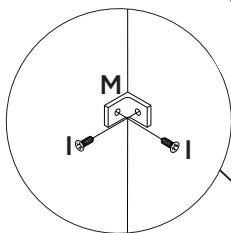

VISTA TRASEIRA

VISTA TRASERA

BACK VIEW

Opção 02
Opción 02
Option 02

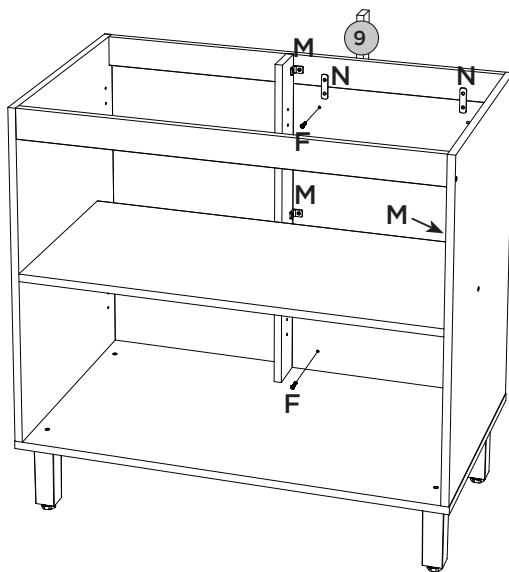
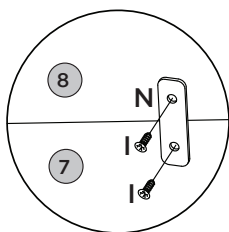

ACESSÓRIOS REQUERIDOS



FERRAMENTAS NECESSÁRIAS

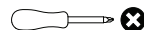

Opção 01
Opción 01
Option 01

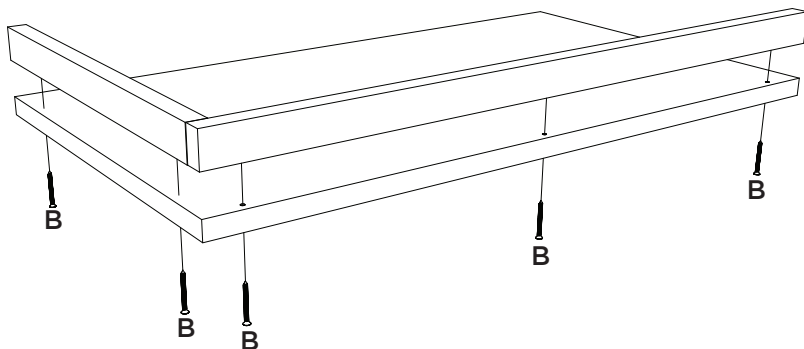

Esse tampo é opcional e é vendido separadamente (C906-128).

Esta vez es opcional y se vende por separado (C906-128).

This top is optional and is sold separately (C906-128).

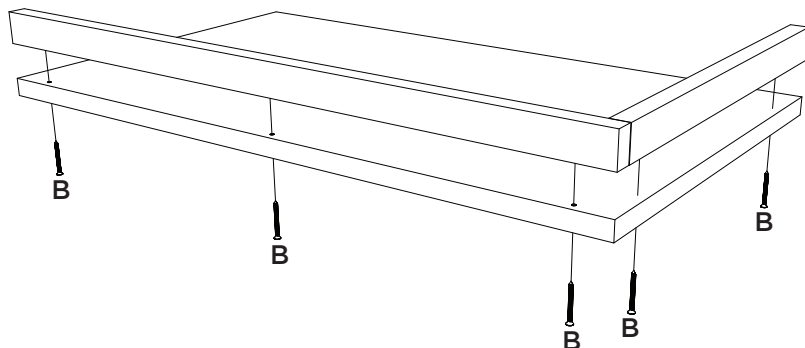

Opção 02
Opción 02
Option 02



PEÇAS REQUERIDAS

10	FUNDO	x2
----	-------	----

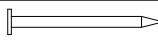
ACESSÓRIOS REQUERIDOS

I		16
K		27
L		07
M		04

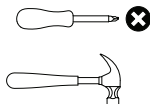
FERRAMENTAS NECESSÁRIAS

Fixar os pregos a uma distância de 100mm de um para outro.

Fijar las uñas a un distancia de 100mm uno a otro.

Fix the nails at a distance of 100mm from one to the other

Opção 01
Opción 01
Option 01

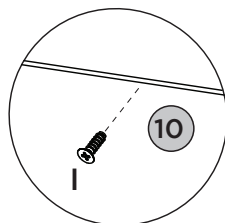
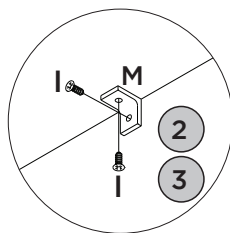
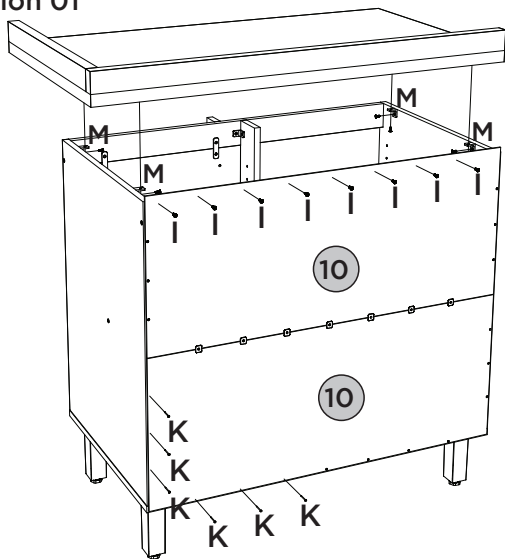

Opção 02
Opción 02
Option 02

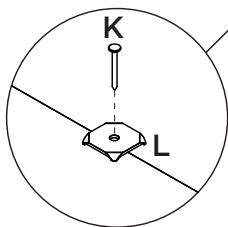
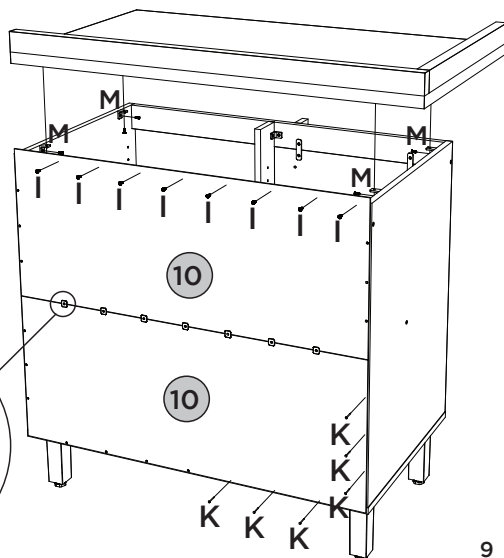



PASSO 6

PEÇAS REQUERIDAS

11	PORTA	x1
----	-------	----

ACESSÓRIOS REQUERIDOS

I		04
P		02

FERRAMENTAS NECESSÁRIAS

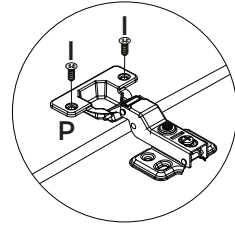
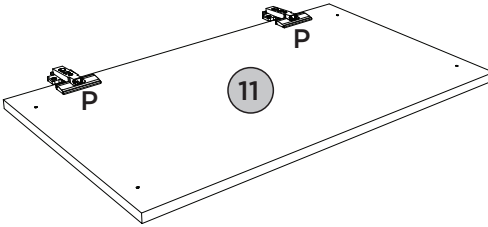
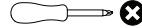



PASSO 7

PEÇAS REQUERIDAS

11	PORTA	x1
----	-------	----

ACESSÓRIOS REQUERIDOS

E		02
I		08
O		01

FERRAMENTAS NECESSÁRIAS

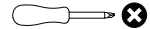

Para porta (11): Defina para o modo de perfuração.
Faça a furação passante para fixar o puxador (O).

Opção 01
Opción 01
Option 01

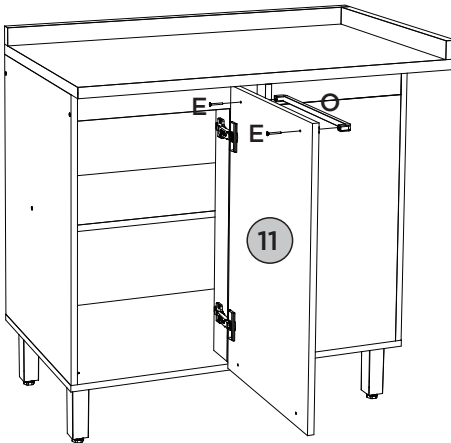

Opção 02
Opción 02
Option 02

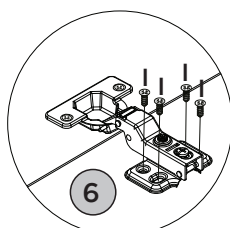
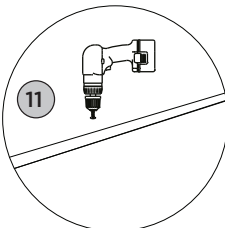
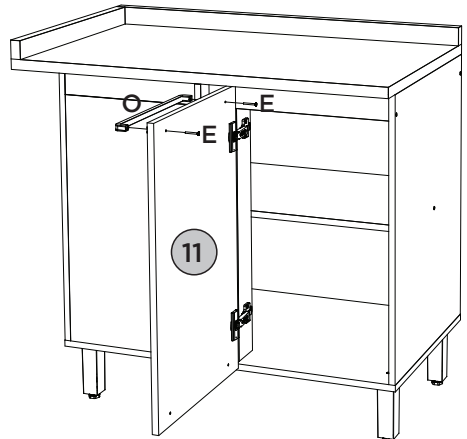

ACESSÓRIOS REQUERIDOS

A		02	U		12
I		04	V		04
R		02	W		03
S		02	Y	HENN	01
T		02			

FERRAMENTAS NECESSÁRIAS



OU

Para parede: Ajustar no modo perfuração
Para peças (02 e 03): Usar torque 5.

Pesos máximos recomendados com carga distribuída
Peso máximo recomendado con la carga distribuida
Recommended maximum weight with distributed load.

PERFECT CORRECTION
CORRECCIÓN PERFECTA

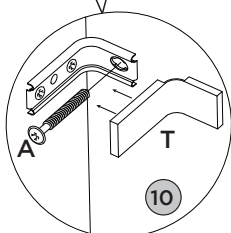
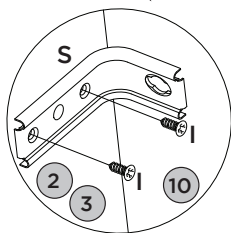
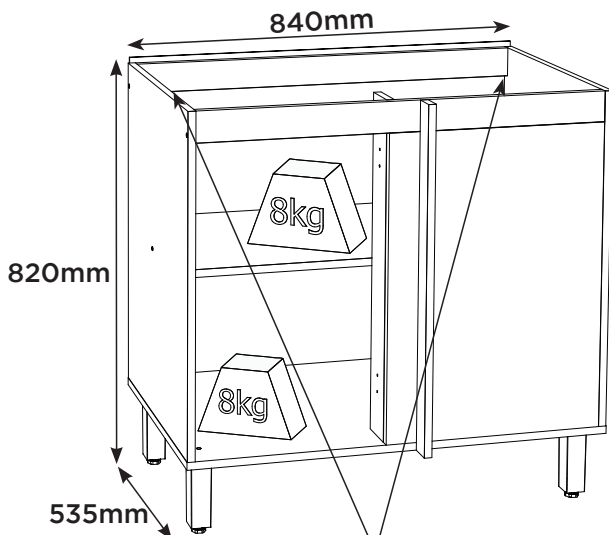
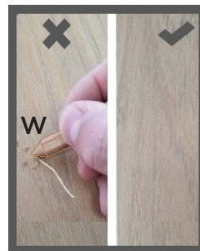

RECOMENDAÇÃO

Para fixar o móvel na parede usar o suporte de fixação (S), o parafuso 4,0x14mm CHT (I), a Bucha 8mm (R) e o parafuso 5,0x50mm FLA (A).

RECOMENDACIÓN

Para conectar el móvil a la pared con el soporte (S), tornillo 4,0x14mm CHT (I), el casquillo de 8 mm (R) y el 5,0 x50mm tornillo FLA (A).

RECOMMENDATION

To fix the furniture to the wall use the fixing bracket (S), the 4,0x14mm CHT (I) screw, the 8mm bushing (R) and the 5,0x50mm FLA screw (A).

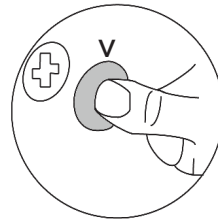
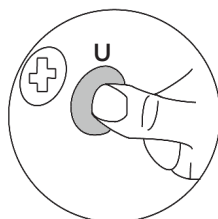

Produto Concluído
Producto terminado
Finished Product

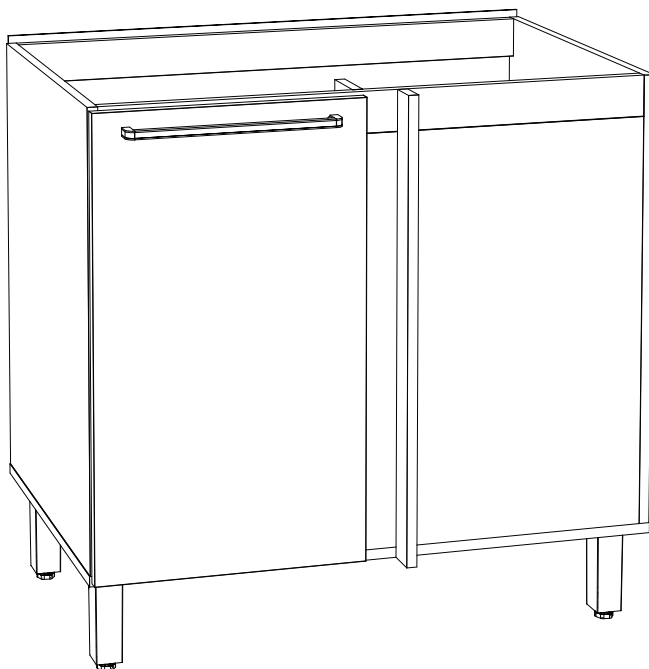

HENNInd. e Com. de Móveis Henn
Mondai - SC - Brasil

☎ +55 49 3674.3500

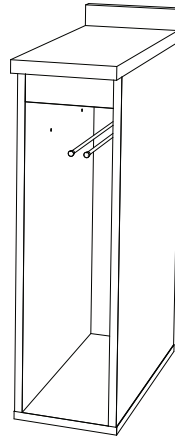
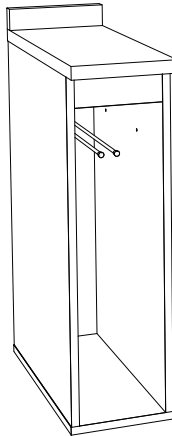
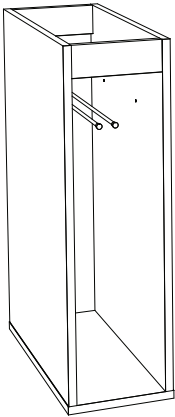
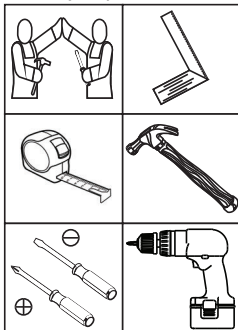
📱 @moveishenn
www.henn.com.br**INSTRUÇÕES DE
MONTAGEM**INSTRUCCIONES DE MONTAJE
ASSEMBLY INSTRUCTIONS**Balcão Porta Toalha Requite | Balcón Puerta Toalla
Requite | Towel Door Counter Requite****C642-128 Nature****Opção 01
Opción 01
Option 01****Opção 02
Opción 02
Option 02****Requisitos para montagem
Requisitos para la montaje
Assembly Requirements**

Imagens meramente ilustrativas,
não acompanha o produto.
Imágenes ilustrativas, no incluidas
con el producto.
Illustrative images, not included
with the product.

AVISO

Para limpeza de seu móvel, use uma flanela seca ou umedecida, e não utilize produtos químicos que possam danificar seu produto.

SISTEMA DE MONTAGEM

O sistema de montagem dos produtos, funciona de acordo com a ordem crescente dos números indicados no desenho. Ex: 01, 02, 03, 04... até a conclusão da montagem.

ASSISTÊNCIA TÉCNICA

Para solicitação de Assistência Técnica você consumidor deverá entrar em contato com o Lojista o qual você realizou a compra deste produto e solicitar a assistência técnica das peças avariadas. A garantia abrange todas as peças, partes e componentes que eventualmente venham apresentar defeito de fabricação no prazo de 03 (três) meses, contando a partir da entrega do produto ao consumidor, mediante nota fiscal de compra. Se houver qualquer alteração na estrutura do produto ou ocorrer defeito por negligência do montador/consumidor em relação a instrução de montagem e manuseio, não será fornecido assistência técnica gratuita.

ADVERTENCIA

Para limpieza de su móvil, use una flanela seca o húmeda, y no utilice productos químicos que puedan dañar su producto.

SISTEMA DE MONTAJE

El sistema de montaje de los productos funciona de acuerdo con el orden creciente de los números indicados en el dibujo. Ej.: 01, 02, 03, 04... hasta la conclusión del montaje.

ASISTENCIA TÉCNICA

Para solicitar Asistencia Técnica, el consumidor debe comunicarse con el Comercio que usted realizó la compra de este producto y solicita asistencia técnica para las partes dañadas. La garantía cubre todas las partes, piezas y componentes que eventualmente puedan presentar defecto de fabricación en el plazo de 03 (tres) meses, contados a partir de la entrega del producto al consumidor, mediante factura de compra. Si se produce algún cambio en la estructura del producto o se produce un defecto por negligencia del montador/consumidor en relación con las instrucciones de montaje y manipulación, no se prestará asistencia técnica gratuita.

NOTICE

To clean your furniture, use a dry or wet cloth, and do not use chemicals that may damage your product.

ASSEMBLY SYSTEM

The products' assembly system works according to the increasing order of the indicated numbers. For example: 01, 02, 03, 04 ... to the end of the assembly.

TECHNICAL ASSISTANCE

To request Technical Assistance, the consumer must contact the retailer from whom you purchased this product and request technical assistance for the damaged parts. The warranty covers all parts, parts and components that may eventually present a manufacturing defect within a period of 03 (three) months, counting from the delivery of the product to the consumer, by means of a purchase invoice. If there is any change in the structure of the product or defect occurs due to negligence of the assembler/consumer in relation to the assembly and handling instruction, free technical assistance will not be provided.

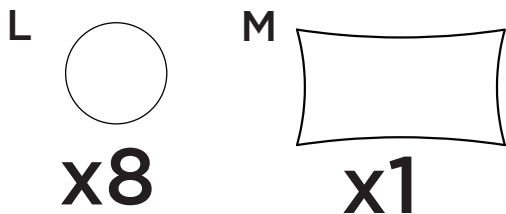
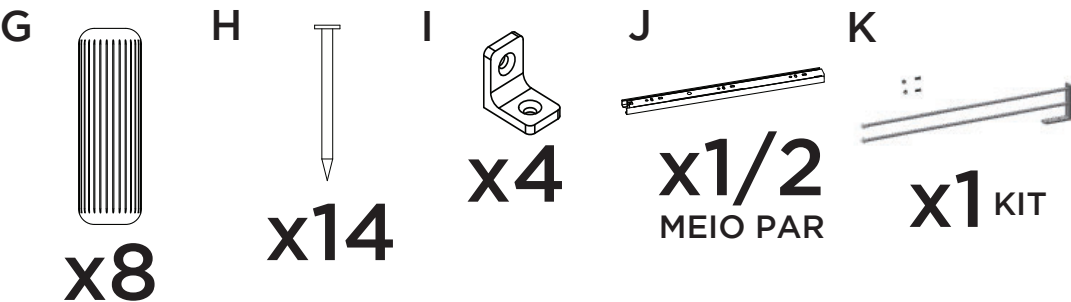
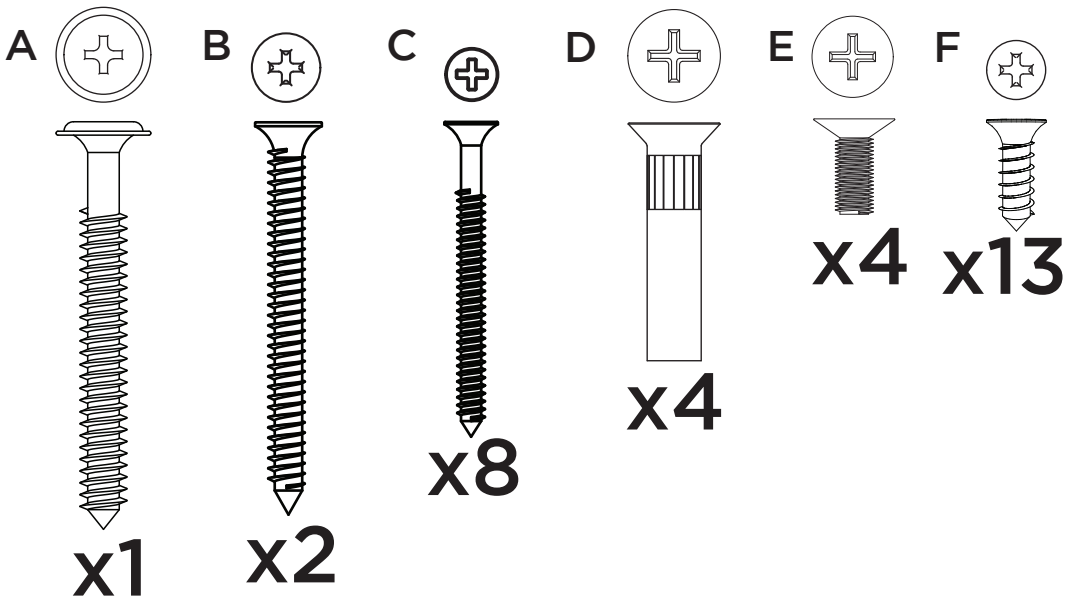



Parafusos em escala
Tornillos escalados
Scaled screws 1:1

 Os parafusos (D/E) devem ser usados somente quando este módulo for acoplado a outro módulo componível Henn.

 Los tornillos (D/E) se debe utilizar sólo cuando el módulo está conectado a otro módulo componible Henn.

 Screws (D/E) are to be used only when this module is mated to another Henn buildable module.

 Caso houver a necessidade de editar o produto, a fita de borda deverá ser utilizada para acabamento.

 En caso de necesidad de editar el producto, la cinta de borde debe utilizarse para el acabado.

 If you need to edit the product, the edge tape should be used for finishing.

LISTA DE PEÇAS | LISTA DE PIEZAS | LIST OF PIECES

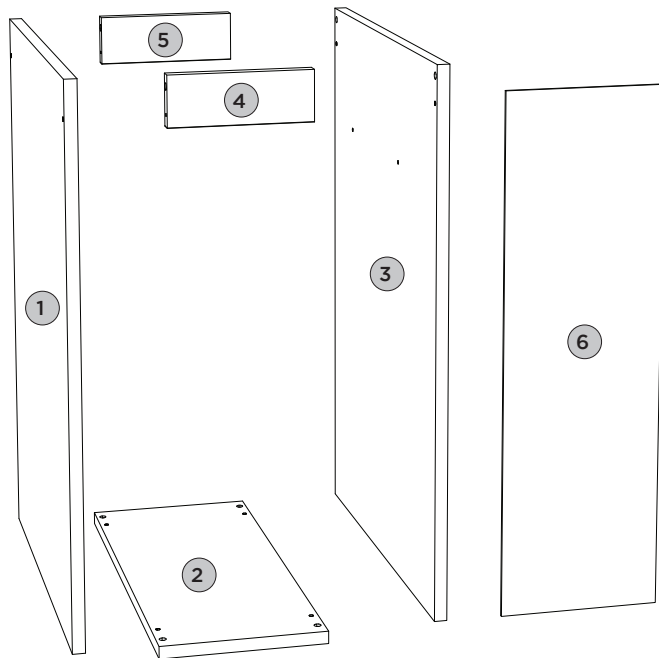

Item	Caixa Caja Box	Qty Ctd Qty	Descrição Descripción Description	Dimensões (mm) Dimensiones (mm)		
				Comprimento Largo Length	Largura Ancho Width	Espessura Grosor Thickness
1	1/1	1	LATERAL ESQUERDA LADO IZQUIERDE LEFT SIDE	660	490	15
2	1/1	1	BASE BASE BASE	490	200	15
3	1/1	1	LATERAL DIREITA LADO DERECHO RIGHT SIDE	660	490	15
4	1/1	1	TRAVESSA FRONTAL TRAVESSAÑO DELANTERO FRONT CROSS MEMEBER	168	60	15
5	1/1	1	TRAVESSA TRASEIRA TRAVESSAÑO TRASERO BACK CROSS MEMEBER	168	60	15
6	1/1	1	FUNDO FONDO BACKGROUND	627	192	3





PASSO 1

ITM/C642-

PEÇAS REQUERIDAS

1	LATERAL ESQUERDA	x1
3	LATERAL DIREITA	x1
4	TRAVESSA FRONTAL	x1
5	TRAVESSA TRASEIRA	x1

ACESSÓRIOS REQUERIDOS

F		07
G		08
I		04
J		1/2
M		

FERRAMENTAS NECESSÁRIAS

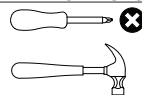

Opção 01
Opción 01
Option 01

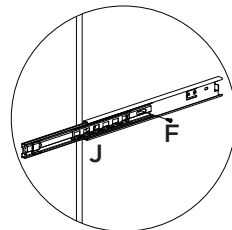
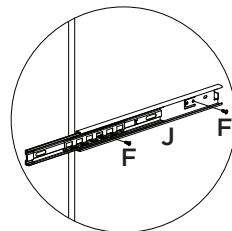
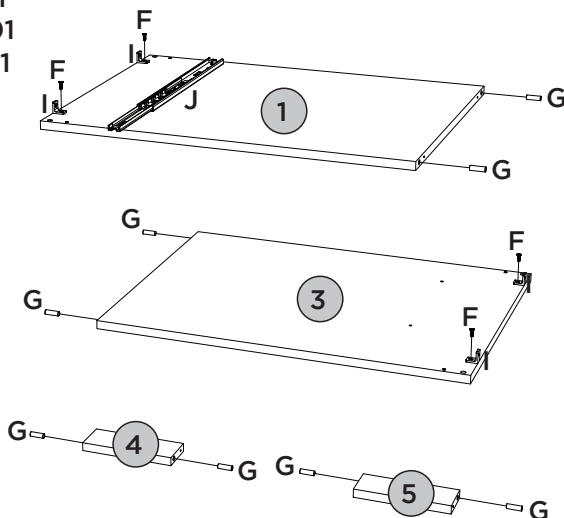

Opção 02
Opción 02
Option 02

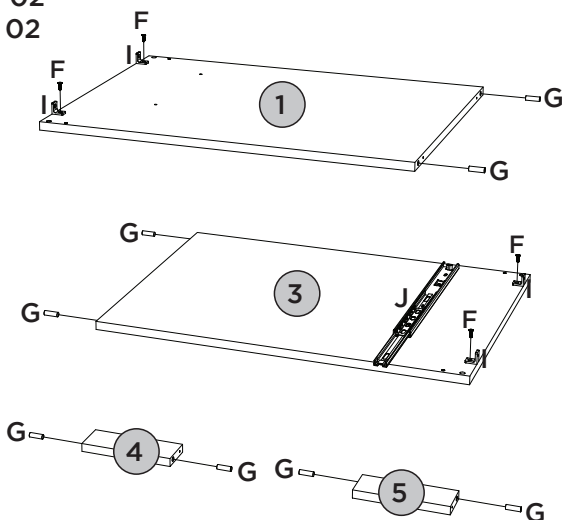

Utilizar o sachê de cola (M) em todas as cavilhas (G) do produto.

Con el pegamento sobre (M) en todos los pernos (G) producto.

Use the glue sachet (M) on all the pegs (G) of the product.



PASSO 2

ITM/C642-

PEÇAS REQUERIDAS

1	LATERAL ESQUERDA	x1
2	BASE	x1
3	LATERAL DIREITA	x1
4	TRAVESSA FRONTAL	x1
5	TRAVESSA TRASEIRA	x1

ACESSÓRIOS REQUERIDOS

C		08
M		

FERRAMENTAS NECESSÁRIAS

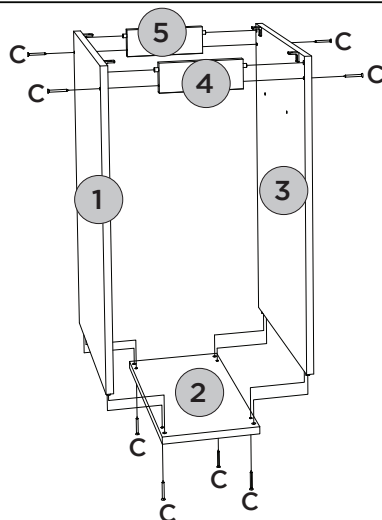
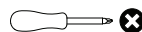



PASSO 3

PEÇAS REQUERIDAS

6	FUNDO	x1
---	-------	----

ACESSÓRIOS REQUERIDOS

F		02
H		14

FERRAMENTAS NECESSÁRIAS

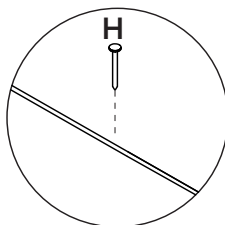
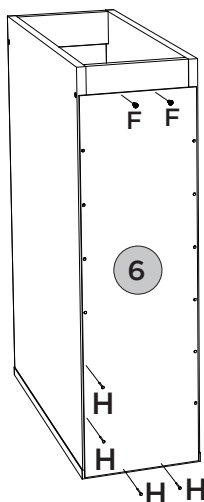
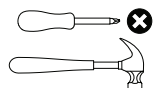





Fixar os pregos a uma distância de 100mm de um para outro.

Fijar las uñas a un distancia de 100 mm uno a otro.

Fix the nails at a distance of 100mm from one to the other

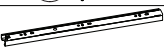
ACESSÓRIOS REQUERIDOS

B		02
F		04
J		1/2
K		01

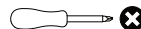
FERRAMENTAS NECESSÁRIAS

Esse topo é opcional e é vendido separadamente (C900-128).

Esta vez es opcional y se vende por separado (C900-128).

This top is optional and is sold separately (C900-128).

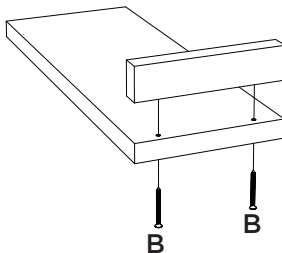

Opção 01
Opción 01
Option 01

Opção 02
Opción 02
Option 02

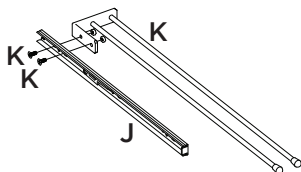
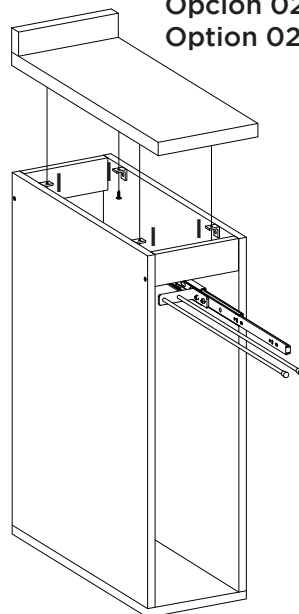
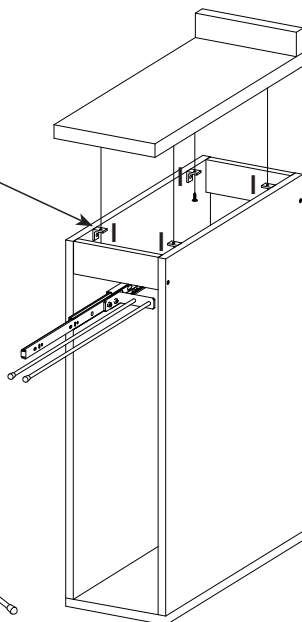
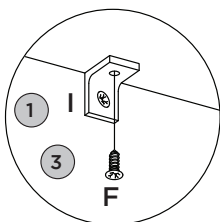



Fixação do toalheiro (K)
na corredeira (J).

La fijación de latoalla
(K) el control deslizante
(J).

fixing the towel rail (K)
on the slide (J).

ACESSÓRIOS REQUERIDOS

A		01
L		08

FERRAMENTAS NECESSÁRIAS



OU



Para parede: Ajustar no modo perfuração

Pesos máximos recomendados com carga distribuída
 Peso máximo recomendado con la carga distribuida
 Recommended maximum weight with distributed load.

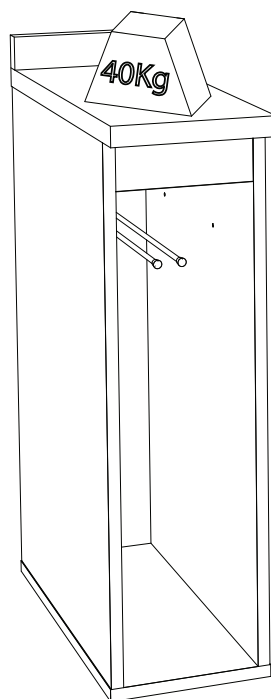
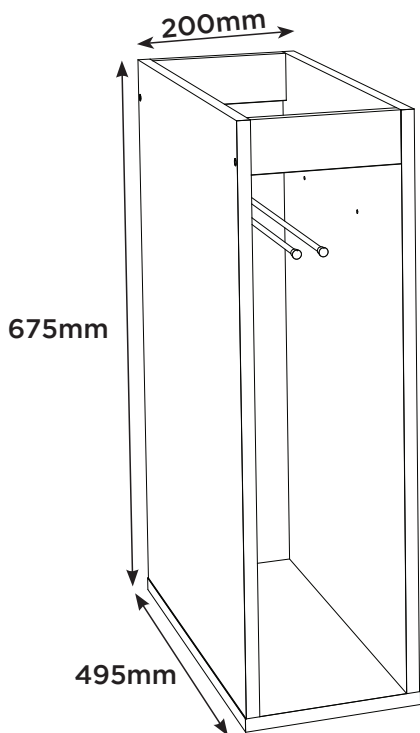

RECOMENDAÇÃO

Para fixar o móvel na parede usar o parafuso 5,0x50mm FLA (A).

RECOMENDACIÓN

Para conectar el móvil a la pared con el 5,0 x50mm tornillo FLA (A).

RECOMMENDATION

To fix the furniture to the wall use the 5.0x50mm FLA screw (A).

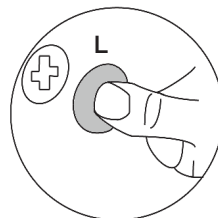

Producto Concluído
Producto terminado
Finished Product

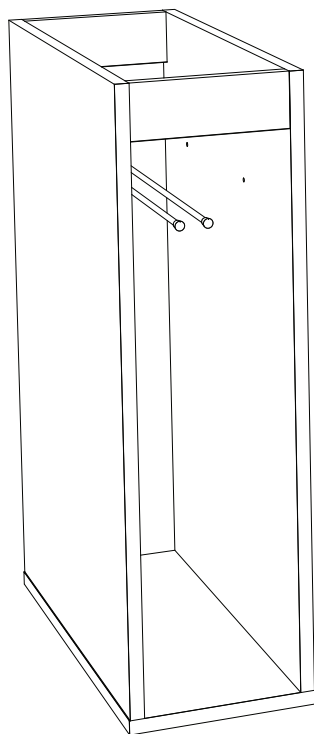

HENNInd. e Com. de Móveis Henn
Mondai - SC - Brasil

☎ +55 49 3674.3500

📷 📧 @moveishenn
www.henn.com.br**INSTRUÇÕES DE
MONTAGEM**INSTRUCCIONES DE MONTAJE
ASSEMBLY INSTRUCTIONS**Torre Quente 02 Fornos 715mm Requite |**

Torre Caliente 02 Hornos 715mm Requite | Hot Tower 02 Ovens 715mm Requite

C643-217 Nature/Areia HP

C643-218 Nature/Nature/Areia HP

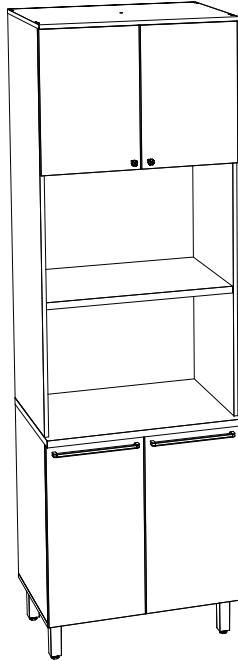
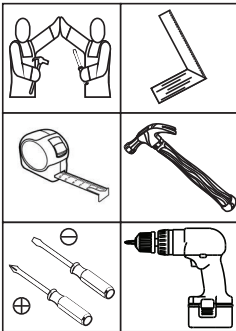
Requisitos para montagem
Requisitos para la montaje
Assembly Requirements

Imagens meramente ilustrativas,
não acompanha o produto.
Imágenes ilustrativas, no incluidas
con el producto.
Illustrative images, not included
with the product.

AVISO

Para limpeza de seu móvel, use uma franela seca ou umedecida, e não utilize produtos químicos que possam danificar seu produto.

SISTEMA DE MONTAGEM

O sistema de montagem dos produtos, funciona de acordo com a ordem crescente dos números indicados no desenho. Ex: 01, 02, 03, 04... até a conclusão da montagem.

ASSISTÊNCIA TÉCNICA

Para solicitação de Assistência Técnica você consumidor deverá entrar em contato com o Lojista a qual você realizou a compra deste produto e solicitar a assistência técnica das peças avariadas. A garantia abrange todas as peças, partes e componentes que eventualmente venham apresentar defeito de fabricação no prazo de 03 (três) meses, contando a partir da entrega do produto ao consumidor, mediante nota fiscal de compra. Se houver qualquer alteração na estrutura do produto ou ocorrer defeito por negligência do montador/consumidor em relação a instrução de montagem e manuseio, não será fornecido assistência técnica gratuita.

ADVERTENCIA

Para limpieza de su móvil, use una franela seca o húmeda, y no utilice productos químicos que puedan dañar su producto.

SISTEMA DE MONTAJE

El sistema de montaje de los productos funciona de acuerdo con el orden creciente de los números indicados en el dibujo. Ej.: 01, 02, 03, 04... hasta la conclusión del montaje.

ASISTENCIA TÉCNICA

Para solicitar Asistencia Técnica, el consumidor debe comunicarse con el Comercio que usted realizó la compra de este producto y solicita asistencia técnica para las partes dañadas. La garantía cubre todas las partes, piezas y componentes que eventualmente puedan presentar defecto de fabricación en el plazo de 03 (tres) meses, contados a partir de la entrega del producto al consumidor, mediante factura de compra. Si se produce algún cambio en la estructura del producto o se produce un defecto por negligencia del montador/consumidor en relación con las instrucciones de montaje y manipulación, no se prestará asistencia técnica gratuita.

NOTICE

To clean your furniture, use a dry or wet cloth, and do not use chemicals that may damage your product.

ASSEMBLY SYSTEM

The products' assembly system works according to the increasing order of the indicated numbers. For example: 01, 02, 03, 04 ... to the end of the assembly.

TECHNICAL ASSISTANCE

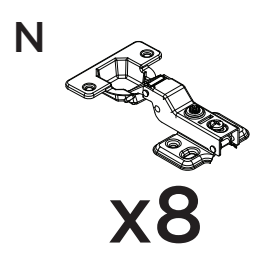
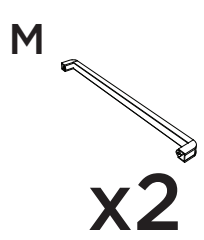
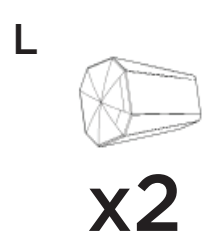
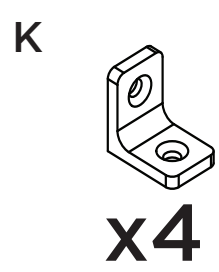
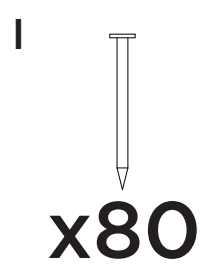
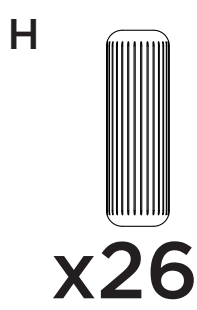
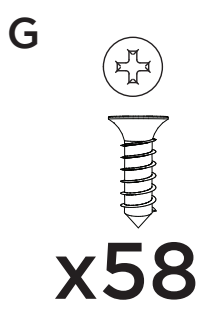
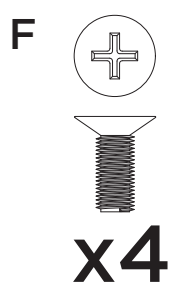
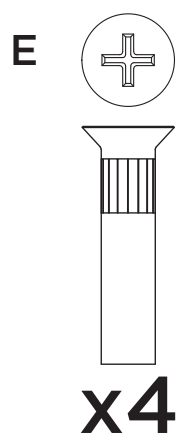
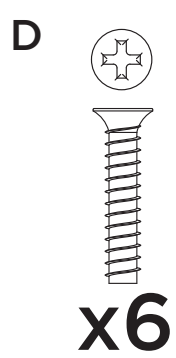
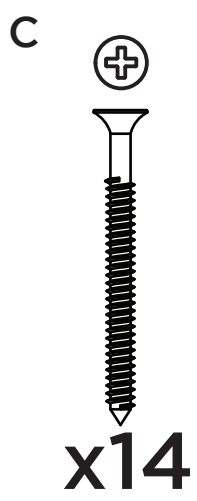
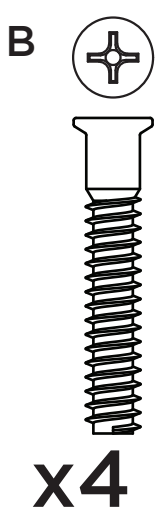
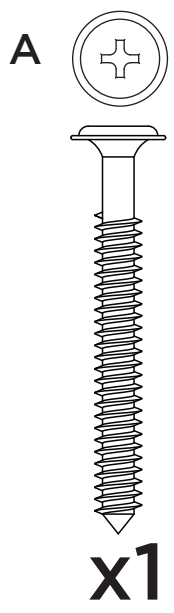

To request Technical Assistance, the consumer must contact the retailer from whom you purchased this product and request technical assistance for the damaged parts. The warranty covers all parts, parts and components that may eventually present a manufacturing defect within a period of 03 (three) months, counting from the delivery of the product to the consumer, by means of a purchase invoice. If there is any change in the structure of the product or defect occurs due to negligence of the assembler/consumer in relation to the assembly and handling instruction, free technical assistance will not be provided.

ACESSÓRIOS | ACCESORIOS | ACCESSORIES

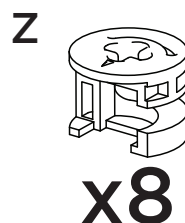
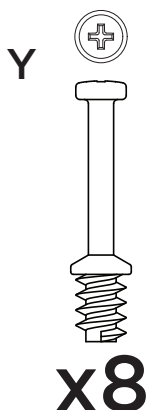
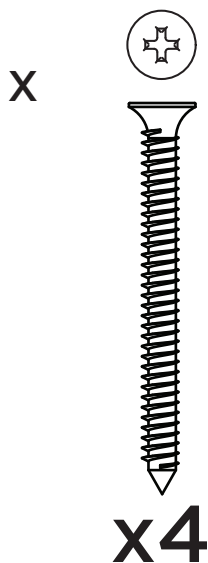
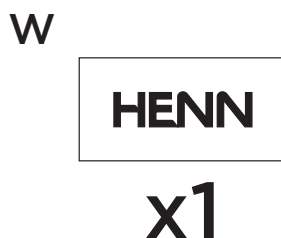
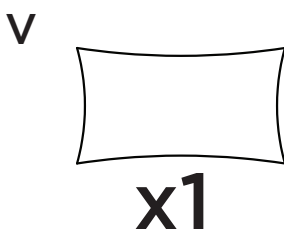
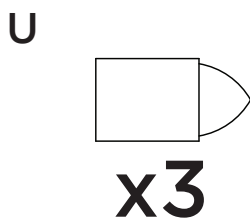
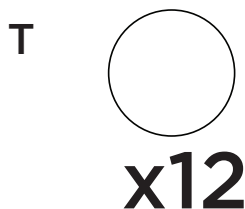
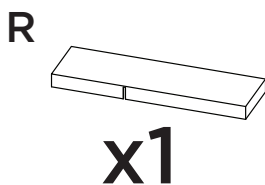
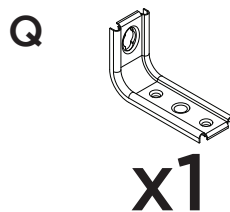
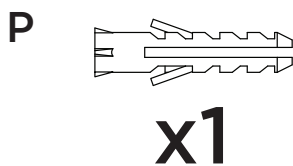
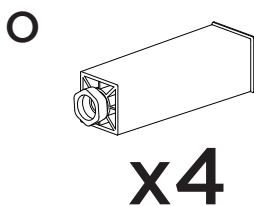

Parafusos em escala
Tornillos escalados
Scaled screws **1:1**

ACESSÓRIOS | ACCESORIOS | ACCESSORIES

Os parafusos (E/F) devem ser usados somente quando este módulo for acoplado a outro módulo componível Henn.



Los tornillos (E/F) se debe utilizar sólo cuando el módulo está conectado a otro módulo componible Henn.



Screws (E/F) are to be used only when this module is mated to another Henn buildable module.

Parafusos em escala
Tornillos escalados
Scaled screws **1:1**

LISTA DE PEÇAS | LISTA DE PIEZAS | LIST OF PIECES

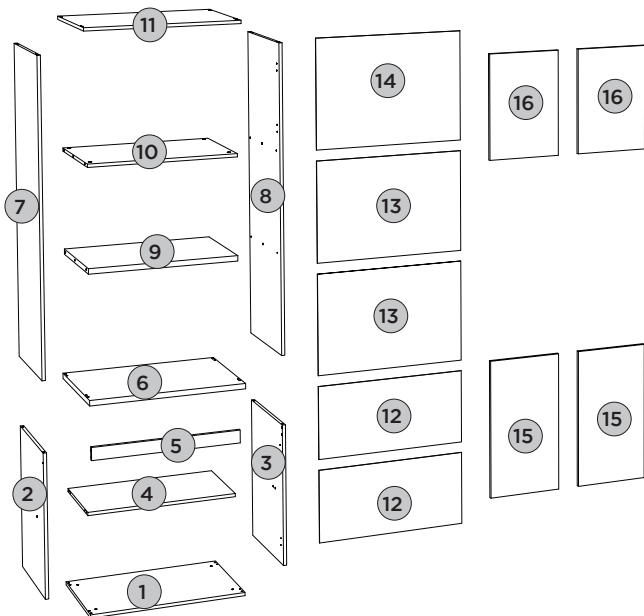

Item	Caixa Caja Box	Qty Ctd Qty	Descrição Descripción Description	Dimensões (mm) Dimensiones (mm)		
				Comprimento Largo Length	Largura Ancho Width	Espessura Grosor Thickness
1	1/1	01	BASE BASE BASE	715	490	15
2	1/1	01	LATERAL ESQUERDA INFERIOR LATERAL IZQUIERDA INFERIOR LEFT SIDE LOWER	660	490	15
3	1/1	01	LATERAL DIREITA INFERIOR LATERAL DERECHA INFERIOR RIGHT SIDE LOWER	660	490	15
4	1/1	01	PRATELEIRA ESTANTE SHELF	684	400	15
5	1/1	01	TRAVESSA FRONTAL TRAVESAÑO FRONTAL FRONT CROSS-BAR	684	60	15
6	1/1	01	TAMPO 25MM TAPA 25MM TOP 25MM	715	533	25
7	1/1	01	LATERAL ESQUERDA SUPERIOR LATERAL IZQUIERDA SUPERIOR UPPER LEFT SIDE	1445	490	15
8	1/1	01	LATERAL DIREITA SUPERIOR LATERAL DERECHA SUPERIOR UPPER RIGHT SIDE	1445	490	15
9	1/1	01	PRATELEIRA CENTRAL ESTANTE CENTRAL CENTRAL SHELF	684	480	25
10	1/1	01	BASE AÉREO BASE AEREO AIR BASE	684	490	15
11	1/1	01	TAMPO TAPA TOP	715	517	15
12	1/1	02	FUNDO INFERIOR FONDO INFERIOR LOWER BACKGROUND	708	343	3
13	1/1	02	FUNDO CENTRAL FONDO CENTRAL CENTRAL FUND	708	475	3
14	1/1	01	FUNDO SUPERIOR FONDO SUPERIOR UPPER BACKGROUND	708	517	3
15	1/1	02	PORTA INFERIOR PUERTA INFERIOR LOWER DOOR	665	354	15
16	1/1	02	PORTA PUERTA DOOR	508	354	15





PASSO 1

ITM/C643-

PEÇAS REQUERIDAS

1	BASE	x1
2	LATERAL ESQUERDA INFERIOR	x1
3	LATERAL DIREITA INFERIOR	x1
4	PRATELEIRA	x1
5	TRAVESSA FRONTAL	x1

ACESSÓRIOS REQUERIDOS

B		04
H		14
O		04
V		

FERRAMENTAS NECESSÁRIAS

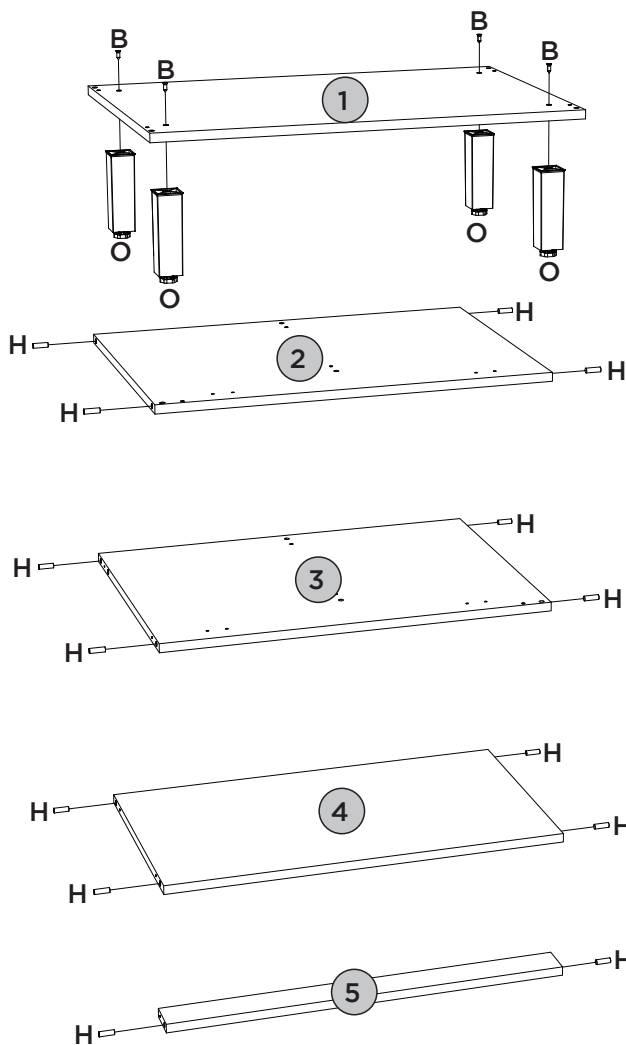
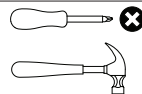

Utilizar o sachê de cola (V) em todas as cavilhas (H) do produto.



Con el pegamento sobre (V) en todos los pernos (H) do producto.

Use the glue sachet (V) on all the pegs (H) of the product.

PASSO 2**PEÇAS REQUERIDAS**

7	LATERAL ESQUERDA SUPERIOR	x1
8	LATERAL DIREITA SUPERIOR	x1
9	PRATELEIRA CENTRAL	x1
10	BASE AÉREO	x1

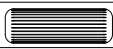

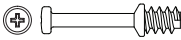
ACESSÓRIOS REQUERIDOS

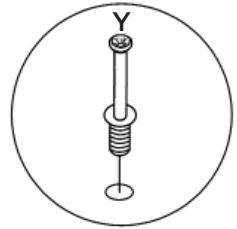
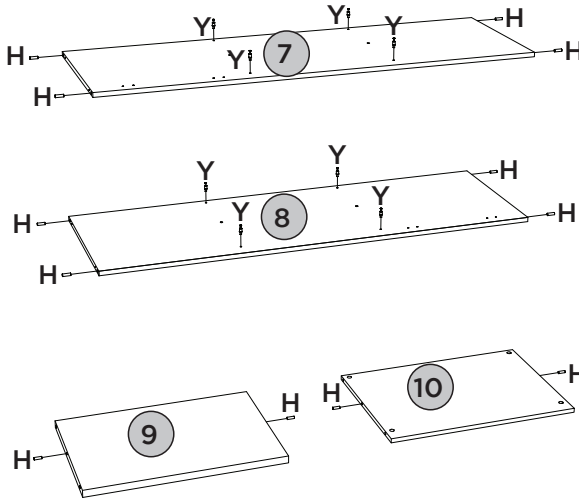
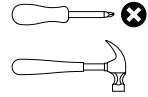
H		12
V		
Y		08

FERRAMENTAS NECESSÁRIAS**PASSO 3****PEÇAS REQUERIDAS**

1	BASE	x1
2	LATERAL ESQUERDA INFERIOR	x1
3	LATERAL DIREITA INFERIOR	x1
4	PRATELEIRA	x1
5	TRAVESSA FRONTAL	x1

ACESSÓRIOS REQUERIDOS



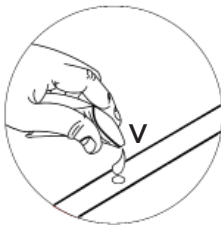
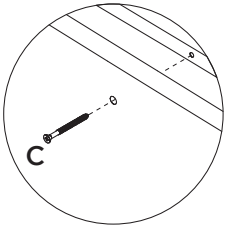
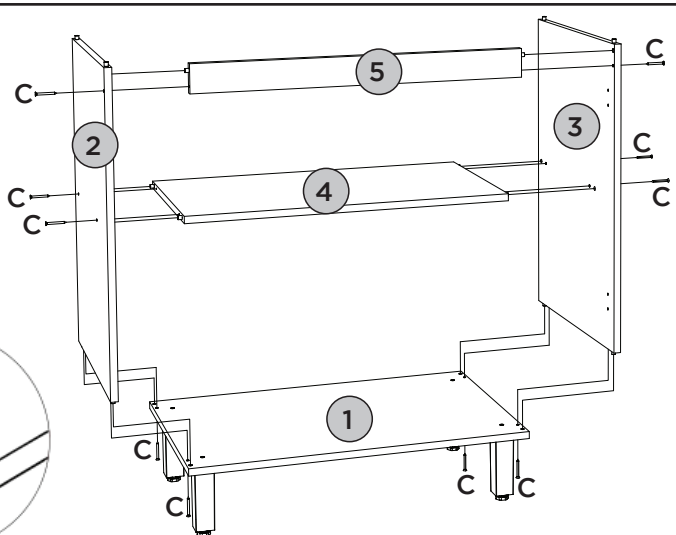
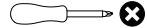

C		10
V		

FERRAMENTAS NECESSÁRIAS

PEÇAS REQUERIDAS

6	TAMPO 25MM	x1
7	LATERAL ESQUERDA SUPERIOR	x1
8	LATERAL DIREITA SUPERIOR	x1
9	PRATELEIRA CENTRAL	x1
10	BASE AÉREO	x1
11	TAMPO	x1

ACESSÓRIOS REQUERIDOS

C		04
V		
X		04
Z		08

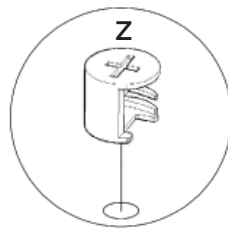
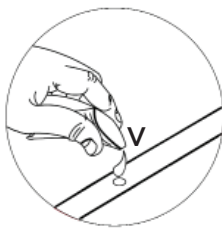
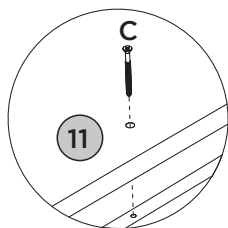
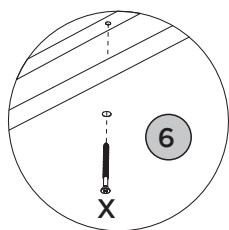
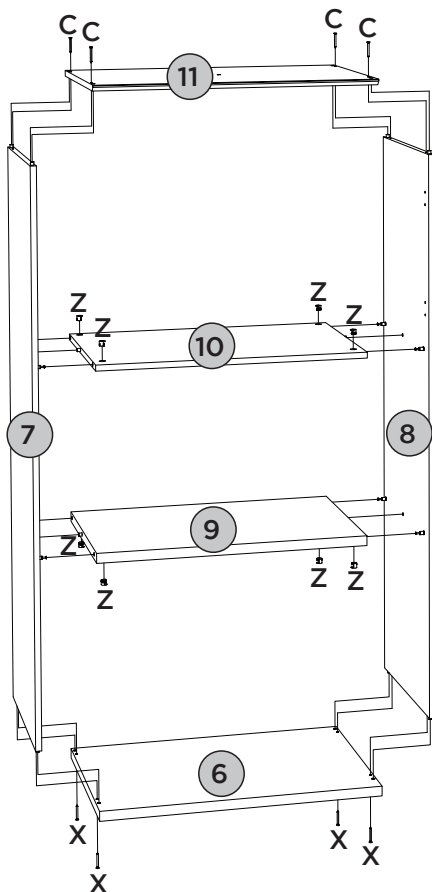
FERRAMENTAS NECESSÁRIAS

PASSO 5

ITM/C643-

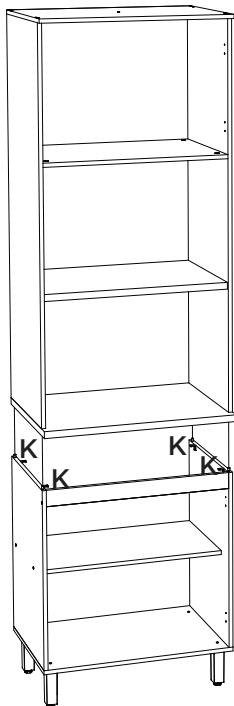

ACESSÓRIOS REQUERIDOS

G		08
K		04
V		

FERRAMENTAS NECESSÁRIAS

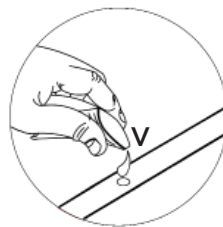
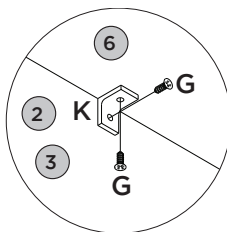
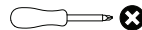

PASSO 6

PEÇAS REQUERIDAS

12	FUNDO INFERIOR	x2
13	FUNDO CENTRAL	x2
14	FUNDO SUPERIOR	x1

ACESSÓRIOS REQUERIDOS

I		80
J		24

FERRAMENTAS NECESSÁRIAS

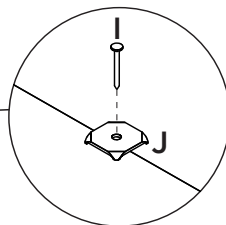
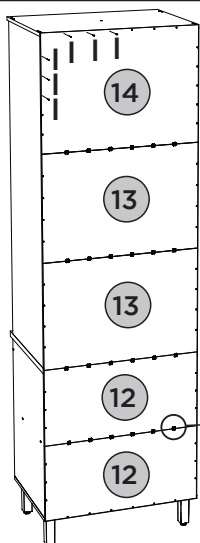
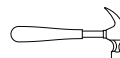

Fixar os pregos a uma distância de 100mm de um para outro.

Fijar las uñas a un distancia de 100mm uno a otro.

Fix the nails at a distance of 100mm from one to the other

PEÇAS REQUERIDAS

15	PORTA INFERIOR	x2
16	PORTA	x2

ACESSÓRIOS REQUERIDOS

G		16
N		08



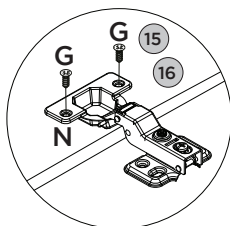
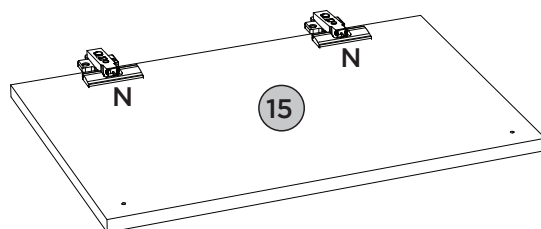
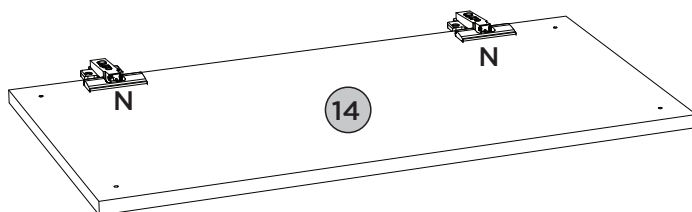
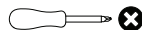



FERRAMENTAS NECESSÁRIAS



PEÇAS REQUERIDAS

15	PORTA INFERIOR	x2
16	PORTA	x2







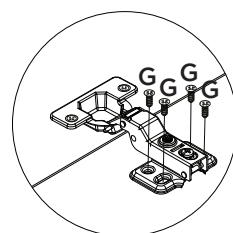
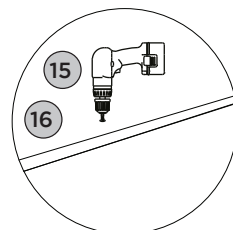
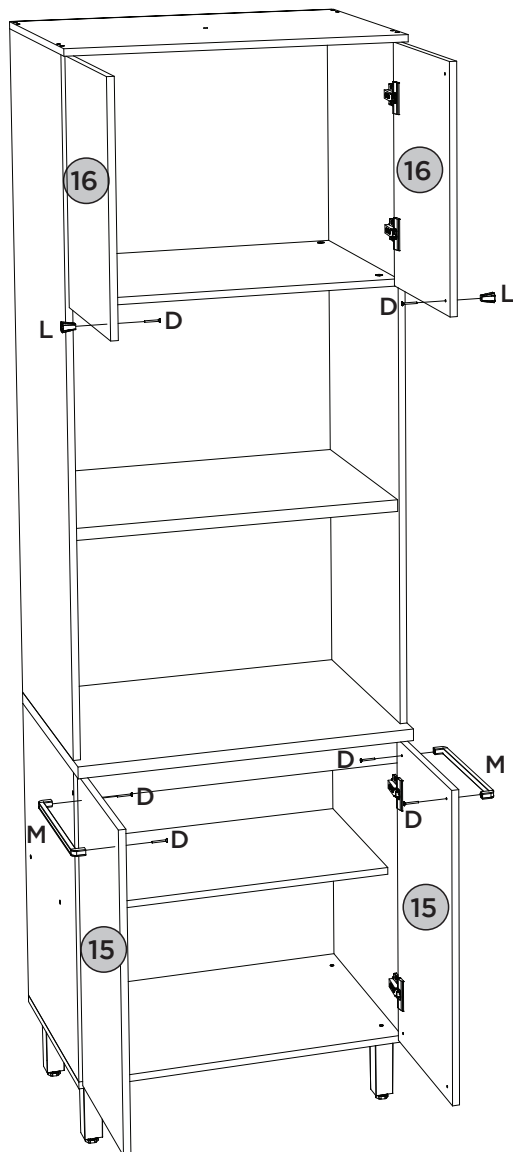
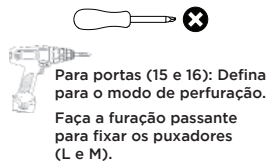

ACESSÓRIOS REQUERIDOS

D	 	06
G	 	32
L		02
M		02

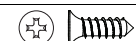
FERRAMENTAS NECESSÁRIAS

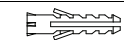

ACESSÓRIOS REQUERIDOS

A		01	S		16
G		02	T		12
P		01	U		03
Q		01	W		01
R		01			

FERRAMENTAS NECESSÁRIAS



OU

Para parede: Ajustar no modo perfuração
Para peça (11): Usar torque 5

Pesos máximos recomendados com carga distribuída
Peso máximo recomendado con la carga distribuida
Recommended maximum weight with distributed load.

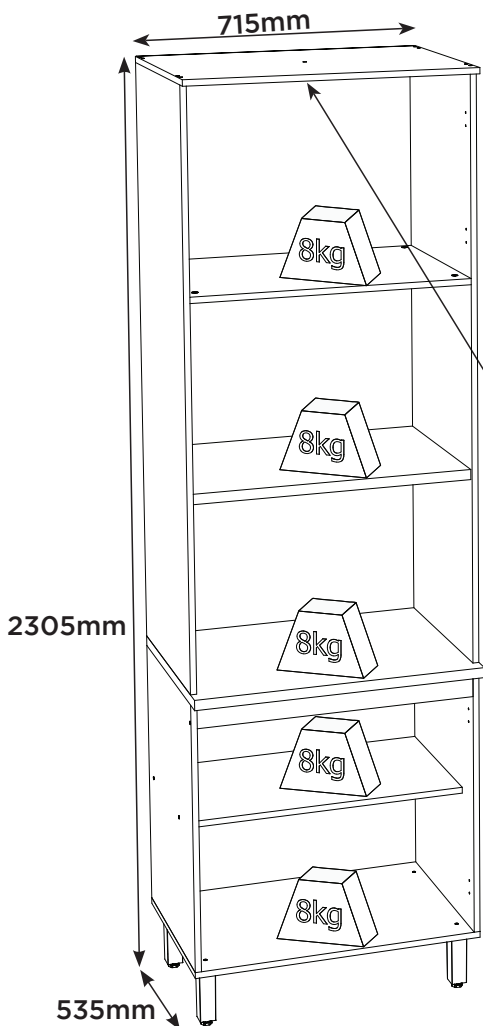

PERFECT CORRECTION
CORRECCIÓN PERFECTA

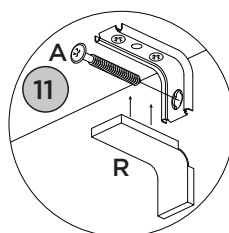
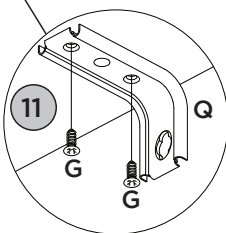
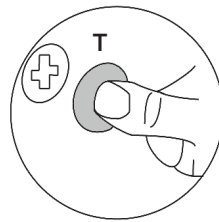
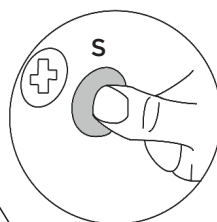
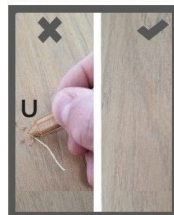

RECOMENDAÇÃO

Para fixar o móvel na parede usar o suporte de fixação (Q), o parafuso 4,0x14mm CHT (G), a Bucha 8mm (P) e o parafuso 5,0x50mm FLA (A).

RECOMENDACIÓN

Para conectar el móvil a la pared con el soporte (Q), tornillo 4,0x14mm CHT (G), el casquillo de 8 mm (P) y el 5,0 x50mm tornillo FLA (A).

RECOMMENDATION

To fix the furniture to the wall use the fixing bracket (Q), the 4,0x14mm CHT (G) screw, the 8mm bushing (P) and the 5.0x50mm FLA screw (A).

Produto Concluído
Producto terminado
Finished Product

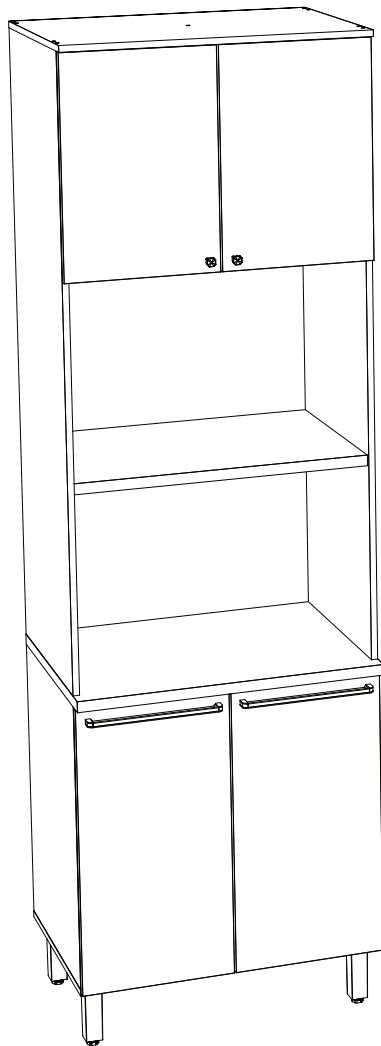

HENNInd. e Com. de Móveis Henn
Mondai - SC - Brasil

☎ +55 49 3674.3500

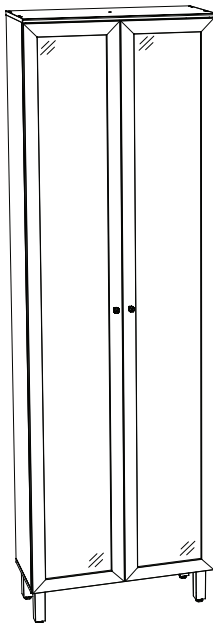
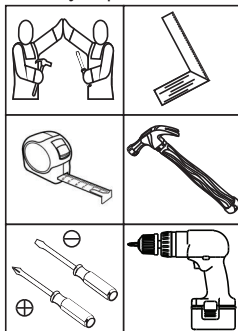
📷 📱 @moveishenn
www.henn.com.br**INSTRUÇÕES DE
MONTAGEM**INSTRUCCIONES DE MONTAJE
ASSEMBLY INSTRUCTIONS**Cristaleira 02 Portas Requite |
Gabinete 02 Puertas Requite | Cabinet 02 Doors Requite****C645-128 Nature
C645-217 Nature/Areia HP****Requisitos para montagem
Requisitos para la montaje
Assembly Requirements**

Imagens meramente ilustrativas,
não acompanha o produto.
Imágenes ilustrativas, no incluidas
con el producto.
Illustrative images, not included
with the product.

AVISO

Para limpeza de seu móvel, use uma flanela seca ou umedecida, e não utilize produtos químicos que possam danificar seu produto.

SISTEMA DE MONTAGEM

O sistema de montagem dos produtos, funciona de acordo com a ordem crescente dos números indicados no desenho. Ex: 01, 02, 03, 04... até a conclusão da montagem.

ASSISTÊNCIA TÉCNICA

Para solicitação de Assistência Técnica você consumidor deverá entrar em contato com o Lojista a qual você realizou a compra deste produto e solicitar a assistência técnica das peças avariadas. A garantia abrange todas as peças, partes e componentes que eventualmente venham apresentar defeito de fabricação no prazo de 03 (três) meses, contando a partir da entrega do produto ao consumidor, mediante nota fiscal de compra. Se houver qualquer alteração na estrutura do produto ou ocorrer defeito por negligência do montador/consumidor em relação a instrução de montagem e manuseio, não será fornecido assistência técnica gratuita.

ADVERTENCIA

Para limpieza de su móvil, use una flanela seca o húmeda, y no utilice productos químicos que puedan dañar su producto.

SISTEMA DE MONTAJE

El sistema de montaje de los productos funciona de acuerdo con el orden creciente de los números indicados en el dibujo. Ej.: 01, 02, 03, 04... hasta la conclusión del montaje.

ASISTENCIA TÉCNICA

Para solicitar Asistencia Técnica, el consumidor debe comunicarse con el Comercio que usted realizó la compra de este producto y solicita asistencia técnica para las partes dañadas. La garantía cubre todas las partes, piezas y componentes que eventualmente puedan presentar defecto de fabricación en el plazo de 03 (tres) meses, contados a partir de la entrega del producto al consumidor, mediante factura de compra. Si se produce algún cambio en la estructura del producto o se produce un defecto por negligencia del montador/consumidor en relación con las instrucciones de montaje y manipulación, no se prestará asistencia técnica gratuita.

NOTICE

To clean your furniture, use a dry or wet cloth, and do not use chemicals that may damage your product.

ASSEMBLY SYSTEM

The products' assembly system works according to the increasing order of the indicated numbers. For example: 01, 02, 03, 04 ... to the end of the assembly.

TECHNICAL ASSISTANCE

To request Technical Assistance, the consumer must contact the retailer from whom you purchased this product and request technical assistance for the damaged parts. The warranty covers all parts, parts and components that may eventually present a manufacturing defect within a period of 03 (three) months, counting from the delivery of the product to the consumer, by means of a purchase invoice. If there is any change in the structure of the product or defect occurs due to negligence of the assembler/consumer in relation to the assembly and handling instruction, free technical assistance will not be provided.

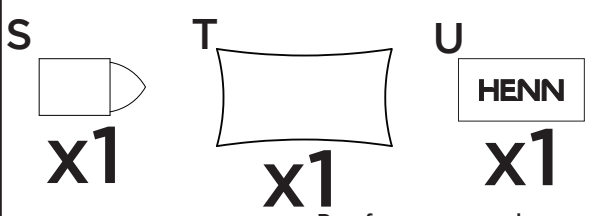
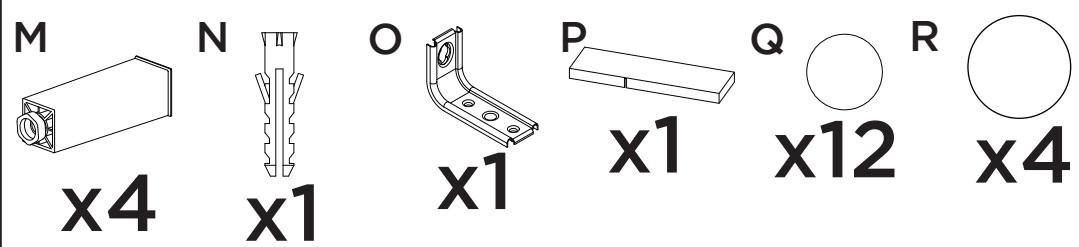
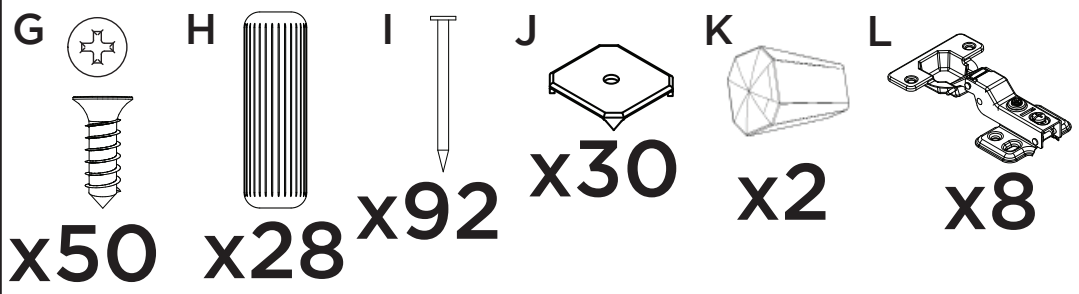
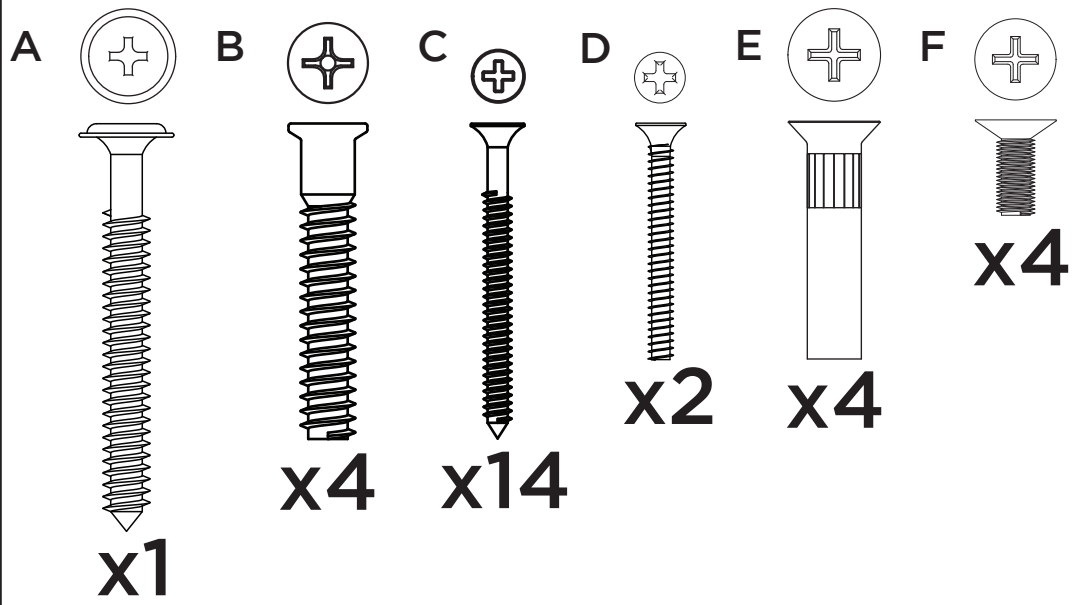

 Os parafusos (E/F) devem ser usados somente quando este módulo for acoplado a outro módulo componível Henn.

 Los tornillos (E/F) se debe utilizar sólo cuando el módulo está conectado a otro módulo componible Henn.

 Screws (E/F) are to be used only when this module is mated to another Henn buildable module.

Parafusos em escada
Tornillos escalados
Scaled screws **1:1**

LISTA DE PEÇAS | LISTA DE PIEZAS | LIST OF PIECES

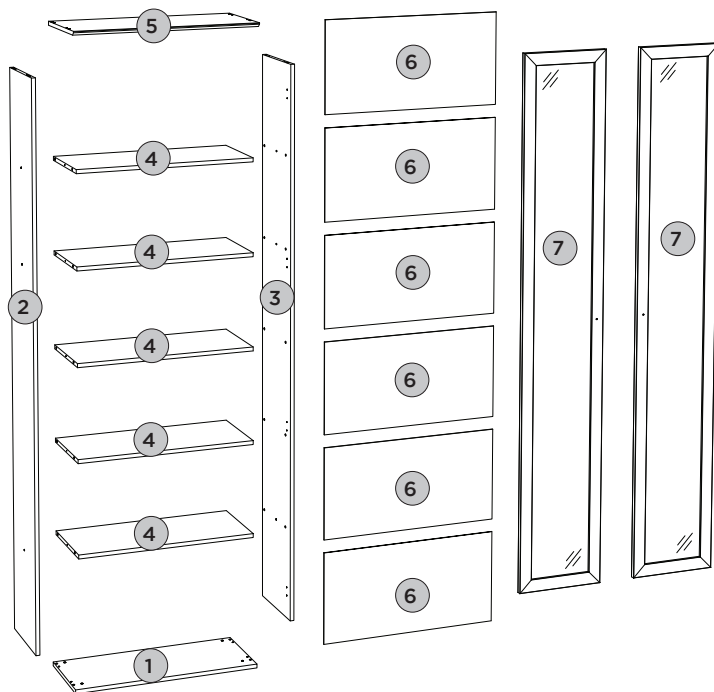





Item	Caja Caja Box	Qty Ctd Qty	Descrição Descripción Description	Dimensões (mm) Dimensiones (mm) Dimensions (mm)		
				Comprimento Largo Length	Largura Ancho Width	Espessura Grosor Thickness
1	1/2	01	BASE BASE BASE	715	295	15
2	2/2	01	LATERAL ESQUERDA LATERAL IZQUIERDA LEFT SIDE	2130	295	15
3	2/2	01	LATERAL DIREITA LATERAL DERECHA RIGHT SIDE	2130	295	15
4	1/2	05	PRATELEIRA ESTANTE SHELF	684	295	15
5	1/2	01	TAMPO TAPA TOP	715	322	15
6	2/2	06	FUNDO FONDO BOTTOM	708	358	3
7	2/2	02	PORTA DE VIDRO TEMPERADA REFLECTA PUERTA DE VIDRIO TEMPLADO REFLECTANTE REFLECT TEMPERED GLASS DOOR	2137	354	15

PASSO 1**PEÇAS REQUERIDAS**

1	BASE	x1
2	LATERAL ESQUERDA	x1
3	LATERAL DIREITA	x1
4	PRATELEIRA	x5

ACESSÓRIOS REQUERIDOS

B		04
H		28
M		04
T		

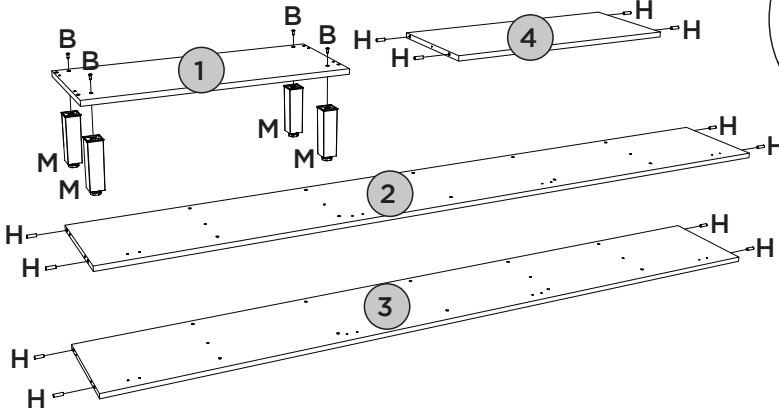
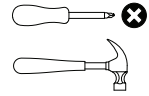
FERRAMENTAS NECESSÁRIAS

Utilizar o sachê de cola (T) em todas as cavilhas (H) do produto.



Con el pegamento sobre (T) en todos los pernos (H) producto.

Use the glue sachet (T) on all the pegs (H) of the product.

PASSO 2**PEÇAS REQUERIDAS**

1	BASE	x1
2	LATERAL ESQUERDA	x1
3	LATERAL DIREITA	x1
4	PRATELEIRA	x5
5	TAMPO	x1

ACESSÓRIOS REQUERIDOS

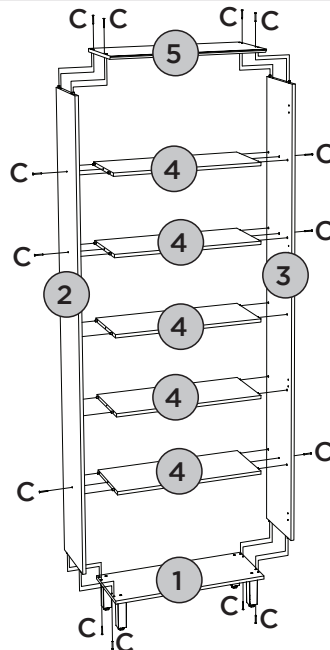
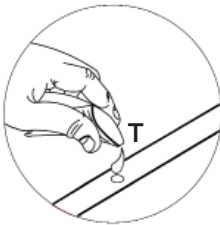
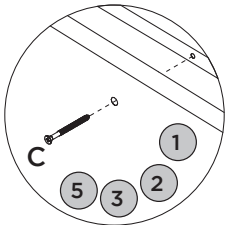

C		14
T		

FERRAMENTAS NECESSÁRIAS

PEÇAS REQUERIDAS

6	FUNDO	x6
---	-------	----

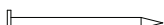
ACESSÓRIOS REQUERIDOS

I		92
J		30

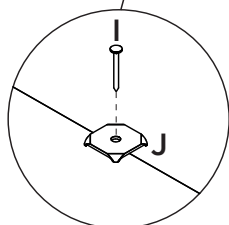
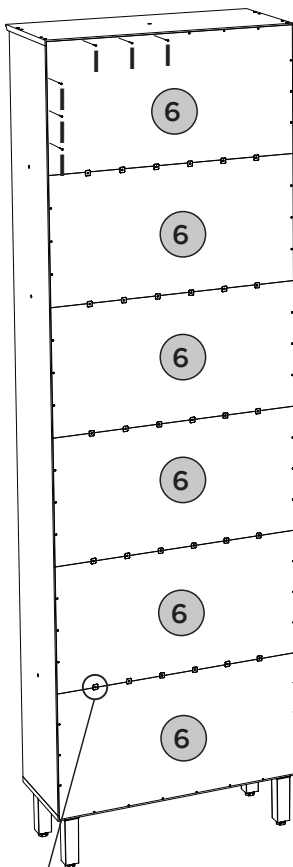
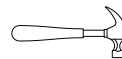
FERRAMENTAS NECESSÁRIAS

Fixar os pregos a uma distância de 100mm de um para outro.

Fijar las uñas a un distancia de 100mm uno a otro.

Fix the nails at a distance of 100mm from one to the other





PASSO 4

ITM/C645-

PEÇAS REQUERIDAS

7	PORTA DE VIDRO TEMPERADA REFLECTA	x2
---	--------------------------------------	----

ACESSÓRIOS REQUERIDOS

D		02
G		16
K		02
L		08

FERRAMENTAS NECESSÁRIAS

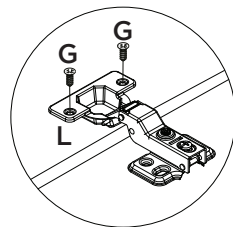
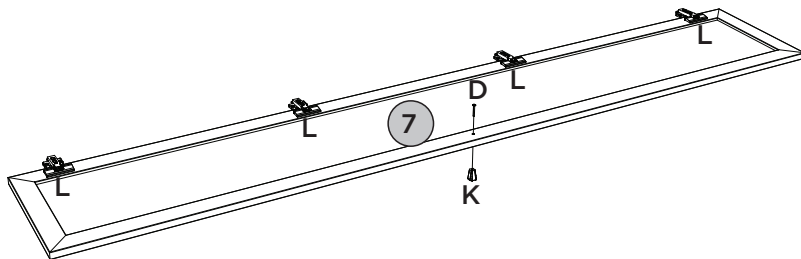
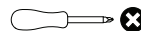

PASSO 5

PEÇAS REQUERIDAS

7	PORTA DE VIDRO TEMPERADA REFLECTA	x2
---	--------------------------------------	----

ACESSÓRIOS REQUERIDOS

G		32
---	---	----

FERRAMENTAS NECESSÁRIAS

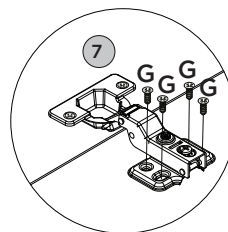
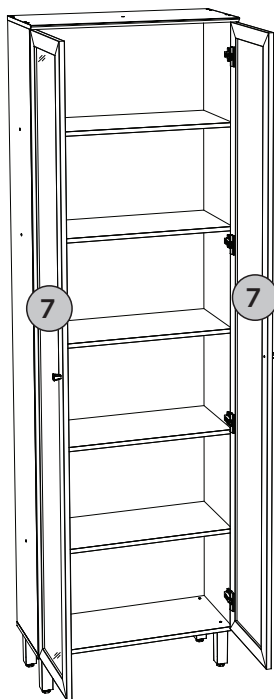
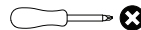

ACESSÓRIOS REQUERIDOS

A		01
G		02
N		01
O		01
P		01

Q		12
R		04
S		01
U		01

FERRAMENTAS NECESSÁRIAS



Para parede: Ajustar no modo perfuração
Para peça (5): Usar torque 5

Pesos máximos recomendados com carga distribuída
Peso máximo recomendado con la carga distribuida
Recommended maximum weight with distributed load.

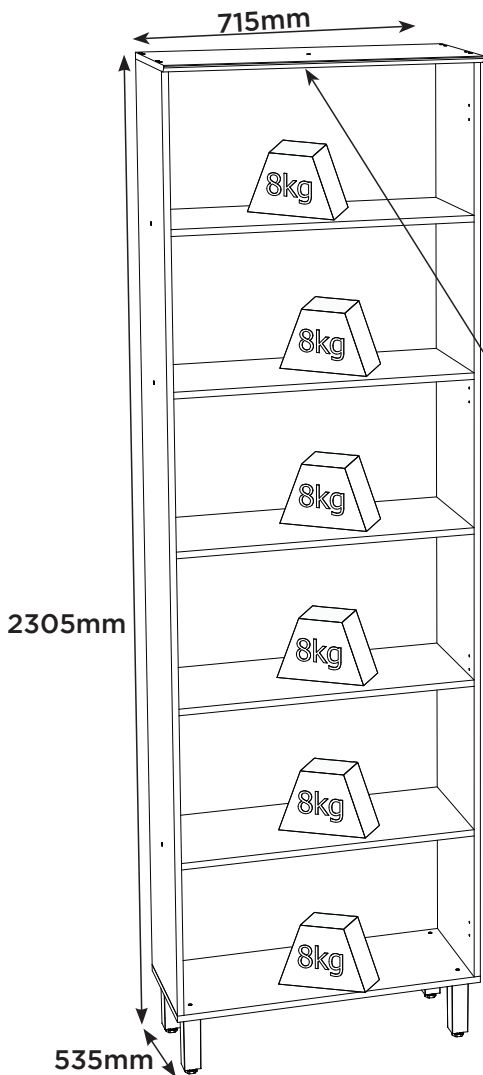

PERFECT CORRECTION
CORRECCIÓN PERFECTA

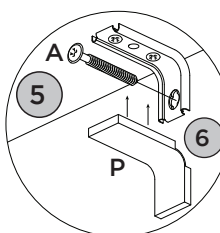
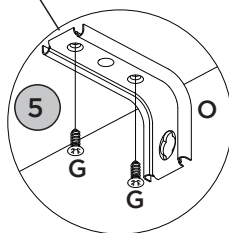
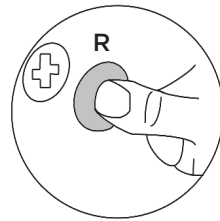
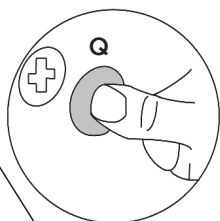
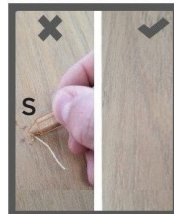

RECOMENDAÇÃO

Para fixar o móvel na parede usar o suporte de fixação (O), o parafuso 4,0x14mm CHT (G), a Bucha 8mm (N) e o parafuso 5,0x50mm FLA (A).

RECOMENDACIÓN

Para conectar el móvil a la pared con el soporte (O), tornillo 4,0x14mm CHT (G), el casquillo de 8 mm (N) y el 5,0 x50mm tornillo FLA (A).

RECOMMENDATION

To fix the furniture to the wall use the fixing bracket (O), the 4,0x14mm CHT (G) screw, the 8mm bushing (N) and the 5.0x50mm FLA screw (A).

Produto Concluído
Producto terminado
Finished Product

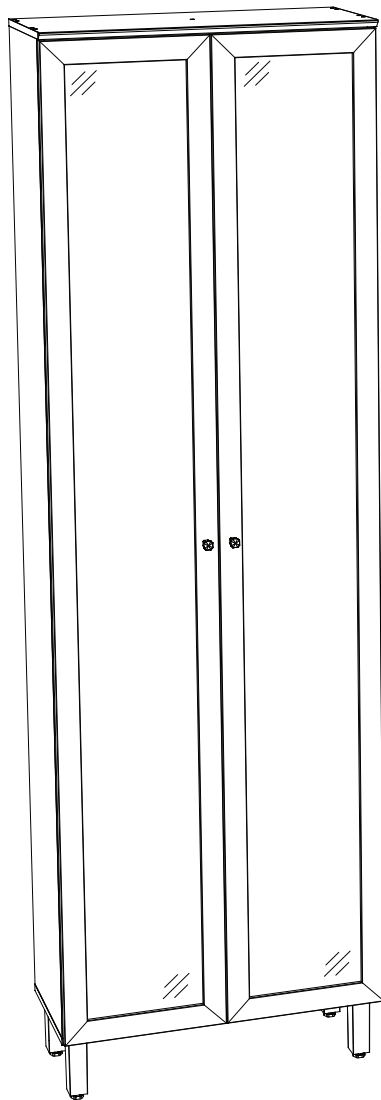

HENNInd. e Com. de Móveis Henn
Mondai - SC - Brasil

☎ +55 49 3674.3500

📧 @moveishenn
www.henn.com.br**INSTRUÇÕES DE MONTAGEM**INSTRUCCIONES DE MONTAJE
ASSEMBLY INSTRUCTIONS**Tampo para Balcão 200mm** | Tablero para Balcón 200mm | Counter Top 200mm

- C900-23 - Duna
- C900-33 - Nero
- C900-114 - Calcare

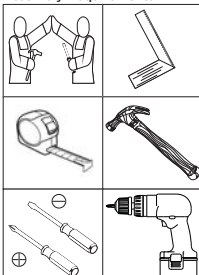
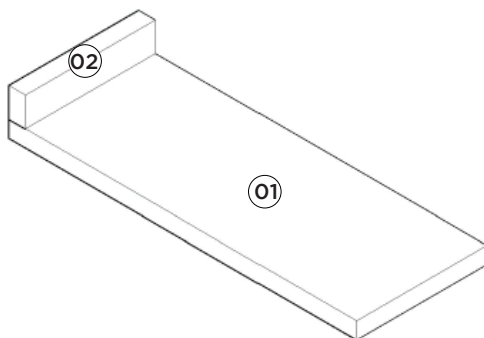
Requisitos para montagem
Requisitor para la montaje
Assembly RequirementsImagens meramente ilustrativas
Imágenes meramente ilustrativas
Images for illustration only**AVISO**

Para limpeza de seu móvel, use uma flanela seca ou umedecida, e não utilize produtos químicos que possam danificar seu produto.

SISTEMA DE MONTAGEM

O sistema de montagem dos produtos, funciona de acordo com a ordem crescente dos números indicados no desenho. Ex: 01, 02, 03, 04... até a conclusão da montagem.

ADVERTENCIA

Para limpieza de su móvil, use una franela seca o húmeda, y no utilice productos químicos que puedan dañar su producto.

SISTEMA DE MONTAJE

El sistema de montaje de los productos funciona de acuerdo con el orden creciente de los números indicados en el dibujo. Ej.: 01, 02, 03, 04... hasta la conclusión del montaje.

NOTICE

To clean your furniture, use a dry or wet cloth, and do not use chemicals that may damage your product.

ASSEMBLY SYSTEM

The products' assembly system works according to the increasing order of the indicated numbers. For example: 01, 02, 03, 04 ... to the end of the assembly.

Lista de Peças | Lista de piezas | List of parts

Item	Caixa Caja Box	Qty Ctd Qty	Descrição Descripción Description	Medidas (mm) Dimensions (mm) Size (measure- ments) (mm)
01	1/1	01	Tampo Tapa Top	533x200x25
02	1/1	01	Rodatampo Rodatampo Rodatampo	200x45x25

Ferragens | Herrajes | Hardware

A	02x	B	08x	C	04x
Parafuso 4,5x50mm CHT. Tornillo 4,5x50mm CHT. Screw 4,5x50mm CHT.		Parafuso 3,5x14mm FLA. Tornillo 3,5x14mm FLA. Screw 3,5x14mm FLA.		Cantoneira plástica Cantонера plástica Plastic angle brackets	

Estas ferragens constam no Pacote do respectivo Balcão.
Estos herrajes constan en el Paquete del respectivo Balcón.
These hardware are included in the Package of the respective Counter.

Esse tampo é opcional e é vendido separadamente

Esta vez es opcional y se vende por separado

This top is optional and is sold separately

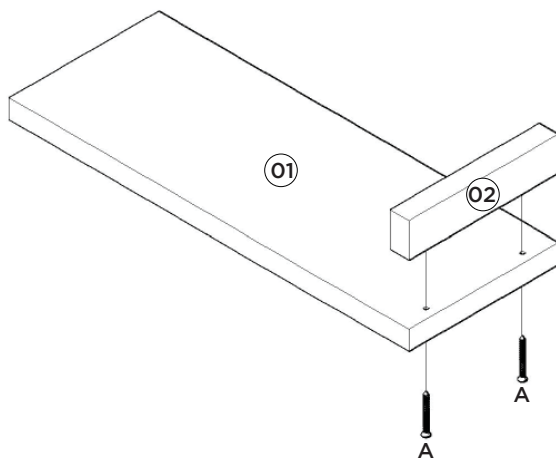

Exemplo de como fixar o Tampo no produto.

Ejemplo de la fijación de la tapa sobre el producto.

Example of fixing the lid on the product.

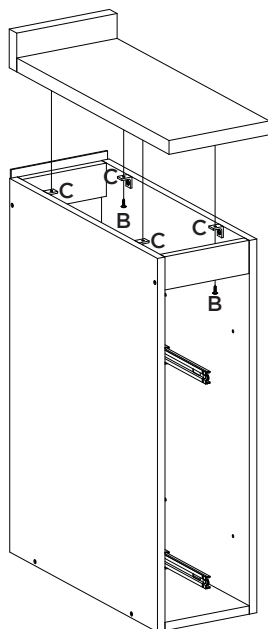

HENNInd. e Com. de Móveis Henn
Mondai - SC - Brasil

☎ +55 49 3674.3500

📧 @moveishenn
www.henn.com.br**INSTRUÇÕES DE MONTAGEM**INSTRUCCIONES DE MONTAJE
ASSEMBLY INSTRUCTIONS**Tampo para Balcão 400mm | Tablero para Balcón 400mm | Counter Top 400mm**

- C902-23 - Duna
- C902-33 - Nero
- C902-114 - Calcare

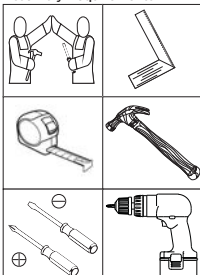
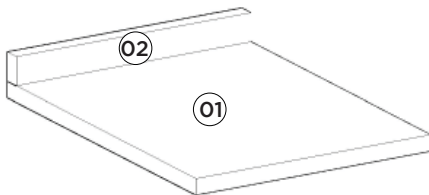
Requisitos para montagem
Requisitor para la montaje
Assembly RequirementsImagens meramente ilustrativas
Imágenes meramente ilustrativas
Images for illustration only**AVISO**

Para limpeza de seu móvel, use uma flanela seca ou umedecida, e não utilize produtos químicos que possam danificar seu produto.

SISTEMA DE MONTAGEM

O sistema de montagem dos produtos, funciona de acordo com a ordem crescente dos números indicados no desenho. Ex: 01, 02, 03, 04... até a conclusão da montagem.

ADVERTENCIA

Para limpieza de su móvil, use una franela seca o húmeda, y no utilice productos químicos que puedan dañar su producto.

Lista de Peças | Lista de piezas | List of parts

Item	Caixa Caja Box	Qtd Ctd Qty	Descrição Descripción Description	Medidas (mm) Dimensions (mm) Size (measure- ments) (mm)
01	1/1	01	Tampo Tapa Top	533x400x25
02	1/1	01	Rodatampo Rodatampo Rodatampo	400x45x25

SISTEMA DE MONTAJE

El sistema de montaje de los productos funciona de acuerdo con el orden creciente de los números indicados en el dibujo. Ej.: 01, 02, 03, 04... hasta la conclusión del montaje.

NOTICE

To clean your furniture, use a dry or wet cloth, and do not use chemicals that may damage your product.

Ferragens | Herrajes | Hardware

A	02x	B	08x	C	04x
Parafuso 4,5x50mm CHT. Tornillo 4,5x50mm CHT. Screw 4,5x50mm CHT.		Parafuso 3,5x14mm FLA. Tornillo 3,5x14mm FLA. Screw 3,5x14mm FLA.		Cantoneira plástica Cantoneira plástica Plastic angle brackets	

Estas ferragens constam no Pacote do respectivo Balcão.
Estos herrajes constan en el Paquete del respectivo Balcón.
These hardware are included in the Package of the respective Counter.

ASSEMBLY SYSTEM

The products' assembly system works according to the increasing order of the indicated numbers. For example: 01, 02, 03, 04 ... to the end of the assembly.

Esse tampo é opcional e é vendido separadamente

Esta vez es opcional y se vende por separado

This top is optional and is sold separately

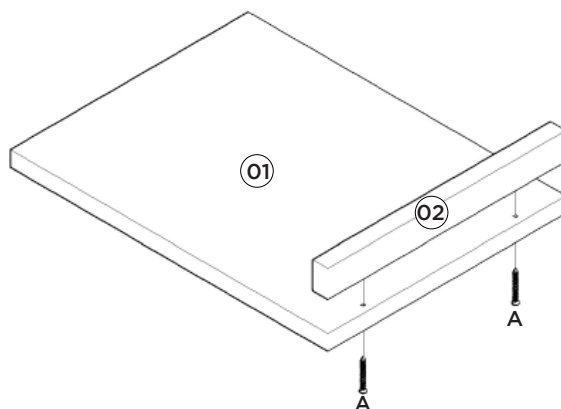

Exemplo de como fixar o Tampo no produto.

Ejemplo de la fijación de la tapa sobre el producto.

Example of fixing the lid on the product.

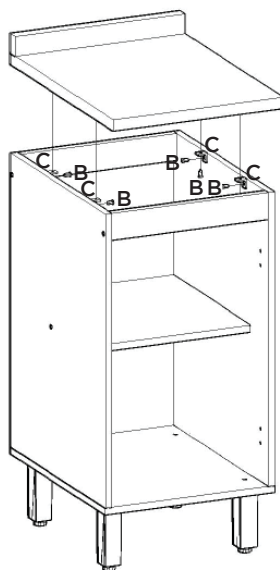

HENNInd. e Com. de Móveis Henn
Mondai - SC - Brasil

☎ +55 49 3674.3500

📧 @moveishenn
www.henn.com.br**INSTRUÇÕES DE MONTAGEM**INSTRUCCIONES DE MONTAJE
ASSEMBLY INSTRUCTIONS**Tampo para Balcão 800mm | Tablero para Balcón 800mm | Counter Top 800mm**

- C904-23 Duna
- C904-33 Nero
- C904-114 Calcare

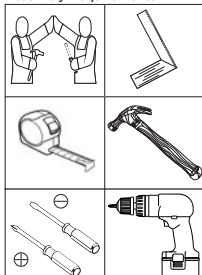
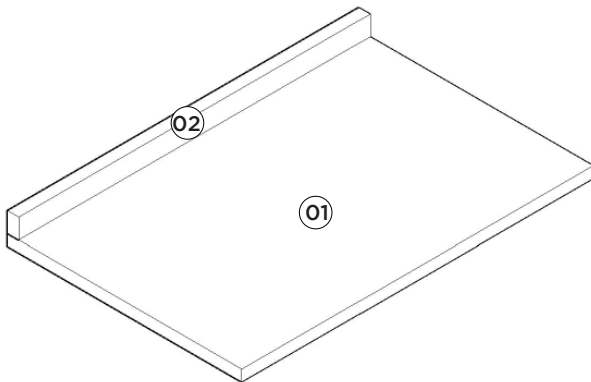
Requisitos para montagem
Requisitor para la montaje
Assembly RequirementsImagens meramente ilustrativas
Imágenes meramente ilustrativas
Images for illustration only**AVISO**

Para limpeza de seu móvel, use uma flanela seca ou umedecida, e não utilize produtos químicos que possam danificar seu produto.

SISTEMA DE MONTAGEM

O sistema de montagem dos produtos, funciona de acordo com a ordem crescente dos números indicados no desenho. Ex: 01, 02, 03, 04... até a conclusão da montagem.

ADVERTENCIA

Para limpieza de su móvil, use una franela seca o húmeda, y no utilice productos químicos que puedan dañar su producto.

Lista de Peças | Lista de piezas | List of parts

Item	Caixa Caja Box	Qty Ctd Qty	Descrição Descripción Description	Medidas (mm) Dimensions (mm) Size (measure- ments) (mm)
01	1/1	01	Tampo Tapa Top	800x533x25
02	1/1	01	Rodatampo Rodatampo Rodatampo	800x45x25

SISTEMA DE MONTAJE

El sistema de montaje de los productos funciona de acuerdo con el orden creciente de los números indicados en el dibujo. Ej.: 01, 02, 03, 04... hasta la conclusión del montaje.

NOTICE

To clean your furniture, use a dry or wet cloth, and do not use chemicals that may damage your product.

Ferragens | Herrajes | Hardware

A	03x	B	08x	C	04x
Parafuso 4,5x50mm CHT. Tornillo 4,5x50mm CHT. Screw 4,5x50mm CHT.		Parafuso 3,5x14mm FLA. Tornillo 3,5x14mm FLA. Screw 3,5x14mm FLA.		Cantoneira plástica Cantонера plástica Plastic angle brackets	

⚠ Estas ferragens constam no Pacote do respectivo Balcão.
Estos herrajes constan en el Paquete del respectivo Balcón.
These hardware are included in the Package of the respective Counter.

ASSEMBLY SYSTEM

The products' assembly system works according to the increasing order of the indicated numbers. For example: 01, 02, 03, 04 ... to the end of the assembly.

Esse tampo é opcional e é vendido separadamente

Esta vez es opcional y se vende por separado

This top is optional and is sold separately

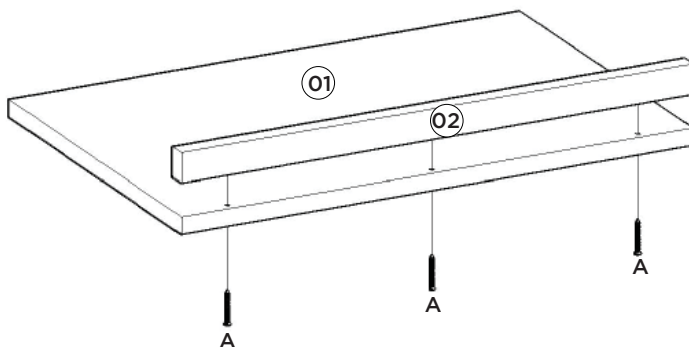

Exemplo de como fixar o Tampo no produto.

Ejemplo de la fijación de la tapa sobre el producto.

Example of fixing the lid on the product.

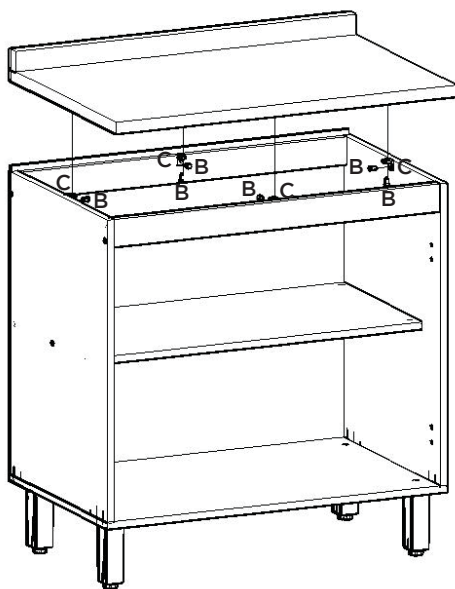

HENNInd. e Com. de Móveis Henn
Mondai - SC - Brasil

☎+55 49 3674.3500

📧📱@moveishenn
www.henn.com.br**INSTRUÇÕES DE MONTAGEM**INSTRUCCIONES DE MONTAJE
ASSEMBLY INSTRUCTIONS**Tampo para Balcão Canto Reto | Tapa para Balcón Canto Reto | Straight Corner Counter Top**

- C906-23 Duna
- C906-33 Nero
- C906-114 Calcare

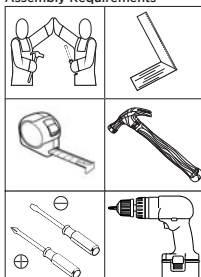
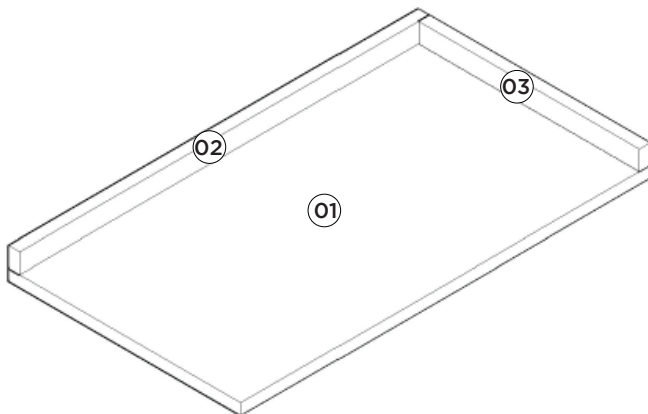
Requisitos para montagem
Requisitor para la montaje
Assembly RequirementsImagens meramente ilustrativas
Imágenes meramente ilustrativas
Images for illustration only**AVISO**

Para limpeza de seu móvel, use uma flanela seca ou umedecida, e não utilize produtos químicos que possam danificar seu produto.

SISTEMA DE MONTAGEM

O sistema de montagem dos produtos, funciona de acordo com a ordem crescente dos números indicados no desenho. Ex: 01, 02, 03, 04... até a conclusão da montagem.

ADVERTENCIA

Para limpieza de su móvil, use una franela seca o húmeda, y no utilice productos químicos que puedan dañar su producto.

SISTEMA DE MONTAJE

El sistema de montaje de los productos funciona de acuerdo con el orden creciente de los números indicados en el dibujo. Ej.: 01, 02, 03, 04... hasta la conclusión del montaje.

NOTICE

To clean your furniture, use a dry or wet cloth, and do not use chemicals that may damage your product.

ASSEMBLY SYSTEM

The products' assembly system works according to the increasing order of the indicated numbers. For example: 01, 02, 03, 04 ... to the end of the assembly.

Lista de Peças | Lista de piezas | List of parts

Item	Caixa Caja Box	Qtd Ctd Qty	Descrição Descripción Description	Medidas (mm) Dimensions (mm) Size (measure- ments) (mm)
01	1/1	01	Tampo Tapa Top	940x533x25
02	1/1	01	Rodatampo Maior Rodatampo Mayor Largest Rodatampo	940x45x25
03	1/1	01	Rodatampo Menor Rodatampo Menor Rodatampo Minor	508x45x25

Ferragens | Herrajes | Hardware

A 05x
Parafuso 4,5x50mm CHT.
Tornillo 4,5x50mm CHT.
Screw 4,5x50mm CHT.

B 08x
Parafuso 3,5x14mm FLA.
Tornillo 3,5x14mm FLA.
Screw 3,5x14mm FLA.

C 04x
Cantoneira plástica
Cantoneira plástica
Plastic angle brackets

⚠ Estas ferragens constam no Pacote do respectivo Balcão.
Estos herrajes constan en el Paquete del respectivo Balcón.
These hardware are included in the Package of the respective Counter.

Esse tampo é opcional e é vendido separadamente

Esta vez es opcional y se vende por separado

This top is optional and is sold separately

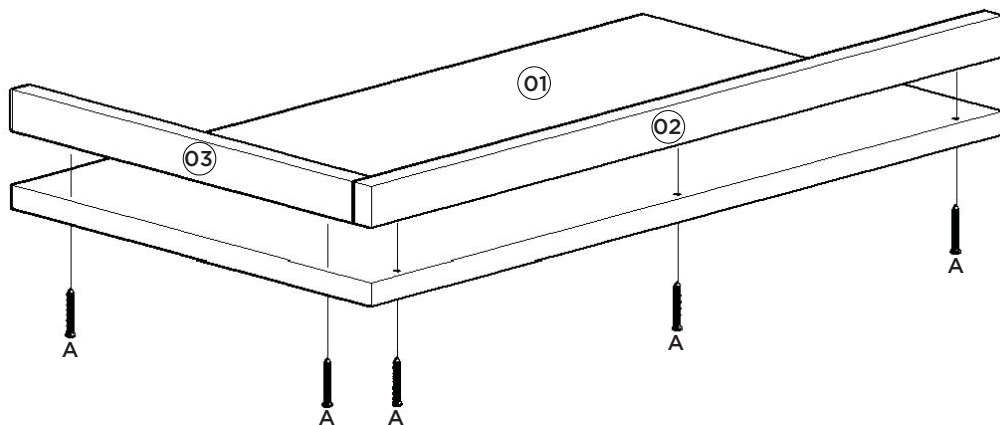

Exemplo de como fixar o Tampo no produto.

Ejemplo de la fijación de la tapa sobre el producto.

Example of fixing the lid on the product.

