

CO7220 - CRISTALEIRA 0,7 M

Manual de Montagem
Assembly Instructions
Instrucción de Montaje

decibal[®]
móveis

Produto Montado
Producto final
Assembled

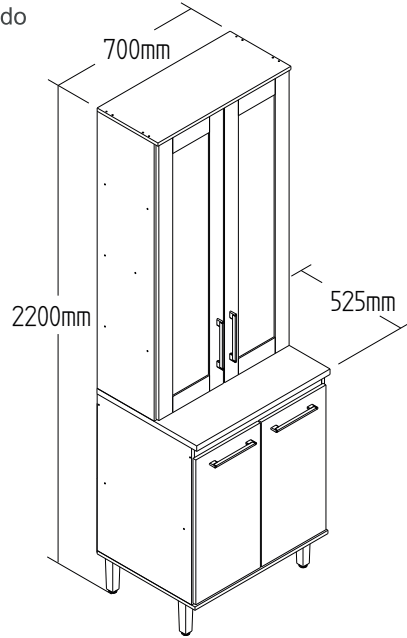

01°

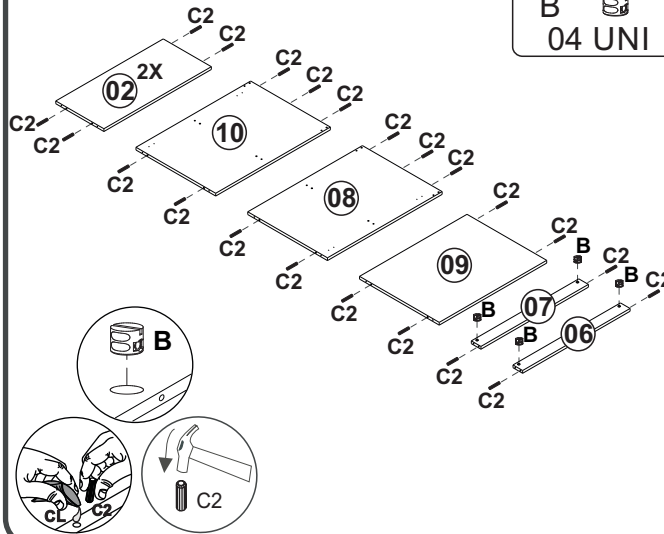

C2 26 UNI

B 04 UNI

02°

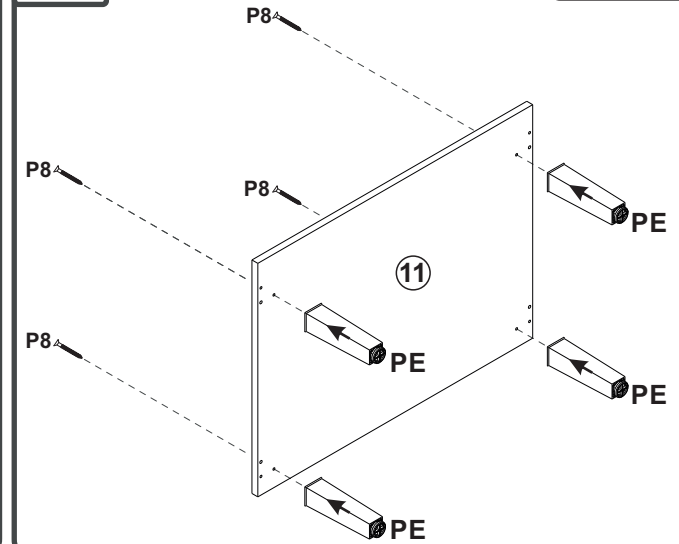

P8 04 UNI

03°

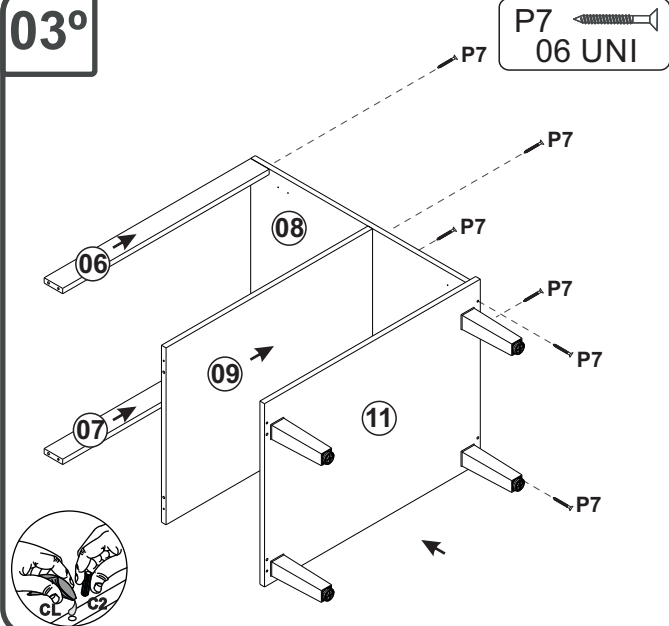

P7 06 UNI

04°

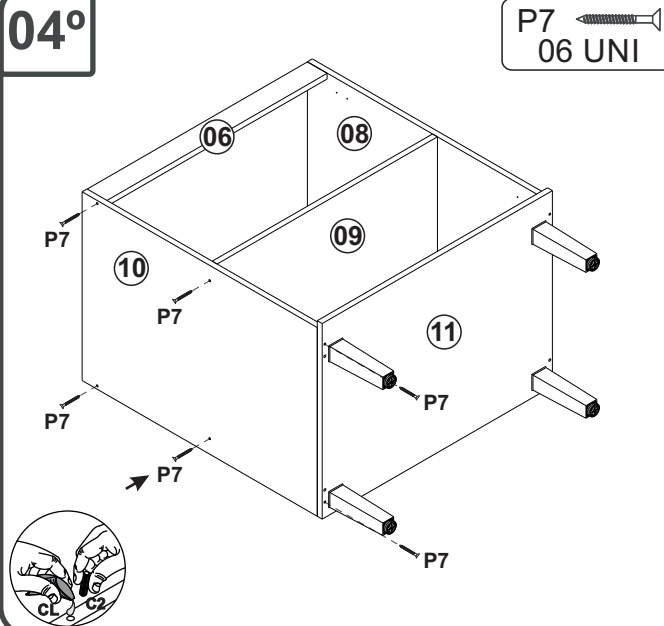

P7 06 UNI

05°

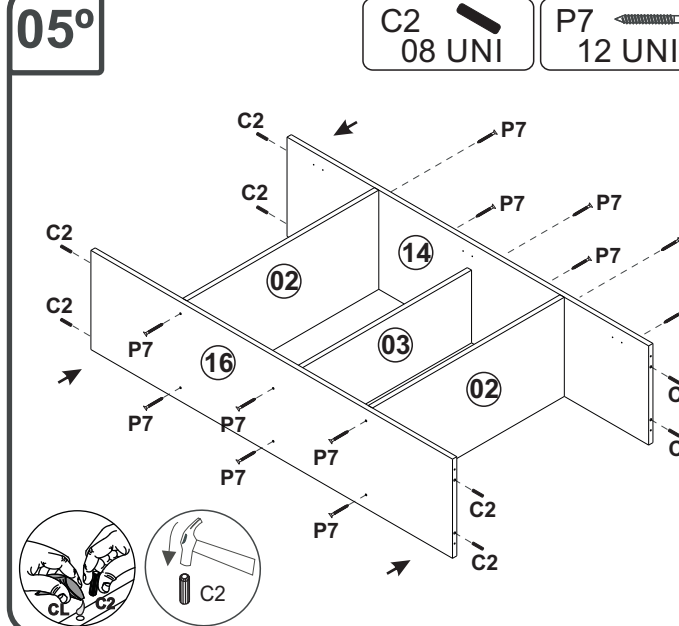

C2 08 UNI

P7 12 UNI

CO7220 - CRISTALEIRA 0,7 M

Manual de Montagem
Assembly Instructions
Instrucción de Montaje

decibal[®]
móveis

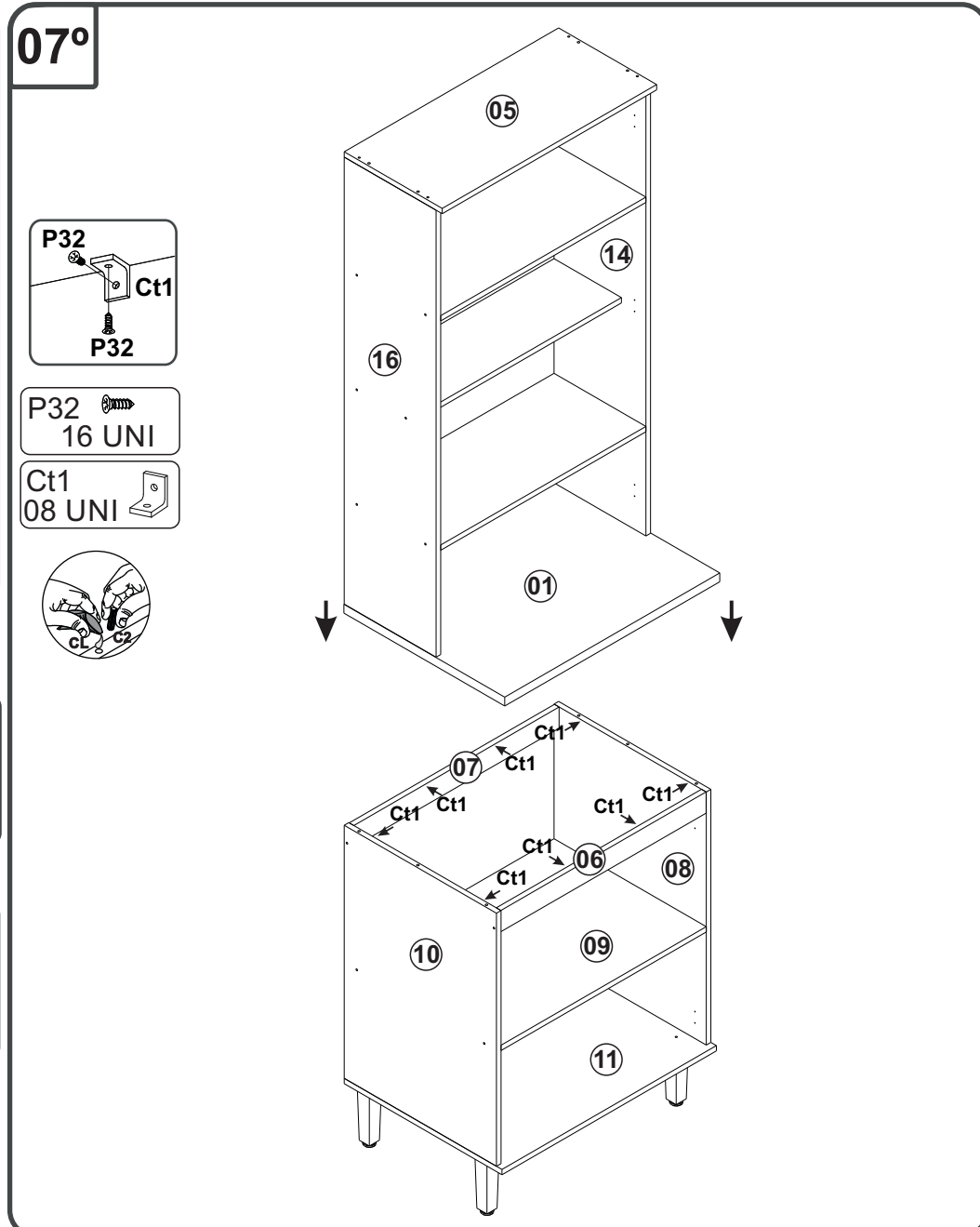
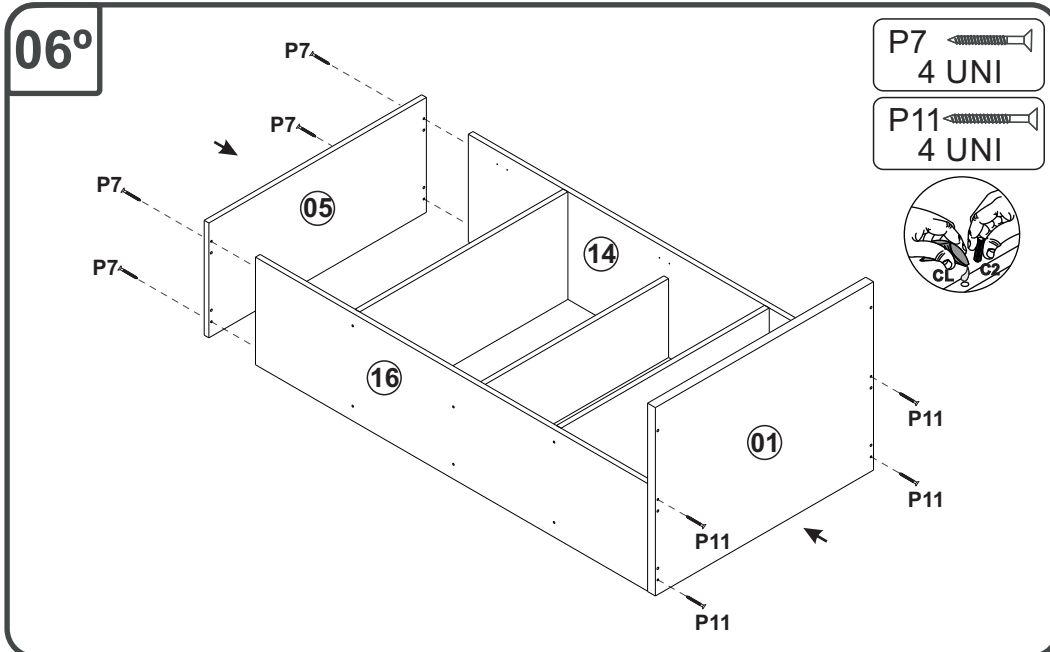

ATENÇÃO!!!! montadores e consumidores
* Ajustar o torque da parafusadeira para não danificar as peças escareando o parafuso *
ATENCIÓN!!!! montadores e consumidores
* Ajuste el torque del destornillador para no dañar las piezas avallanando el tornillo *
ATTENTION!!!! assemblers and consumers
* Adjust the torque of the screwdriver so as not to damage the parts by countersinking the screw *



www.decibal.com.br

60 min.

2 montador
2 ajustador
2 Fitter

CO7220 - CRISTALEIRA 0,7 M

Manual de Montagem
 Assembly Instructions
 Instrucción de Montaje



08° COSTA/REVÉS/BACK



FX
 24 UN

Pr1
 100 UN

P1
 05 UN

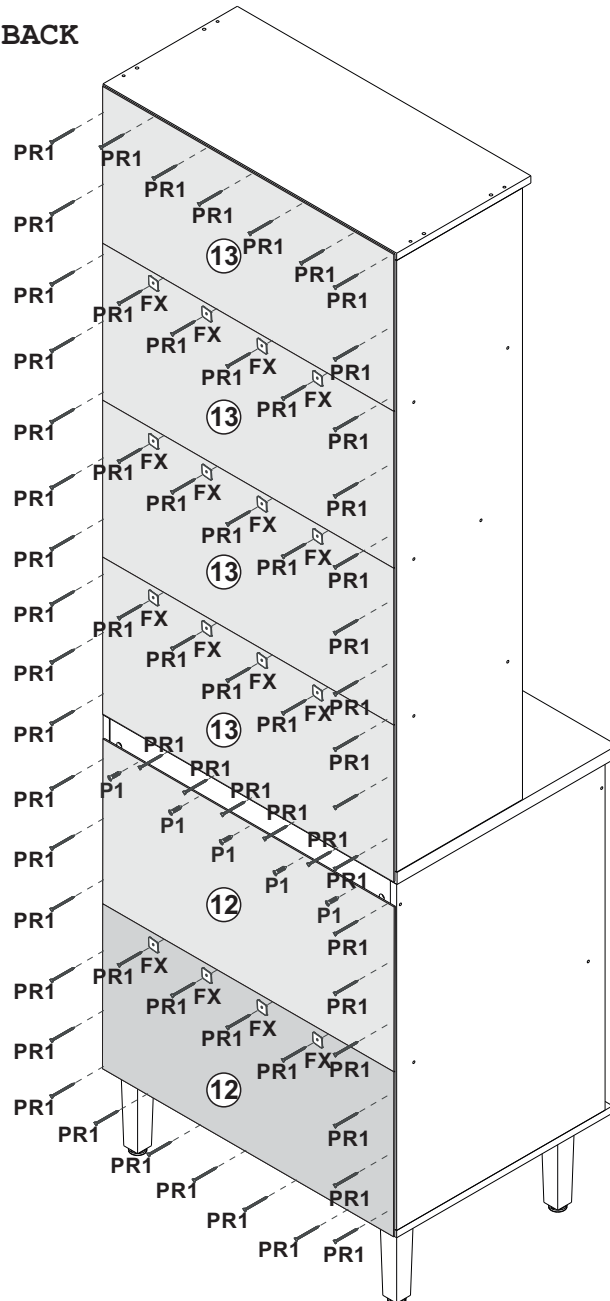

09°



*PESO suportado.
 *PESO SOPORTADO.
 *WEIGHT SUPPORTED.

Fixação parede
 Fixed in the wall

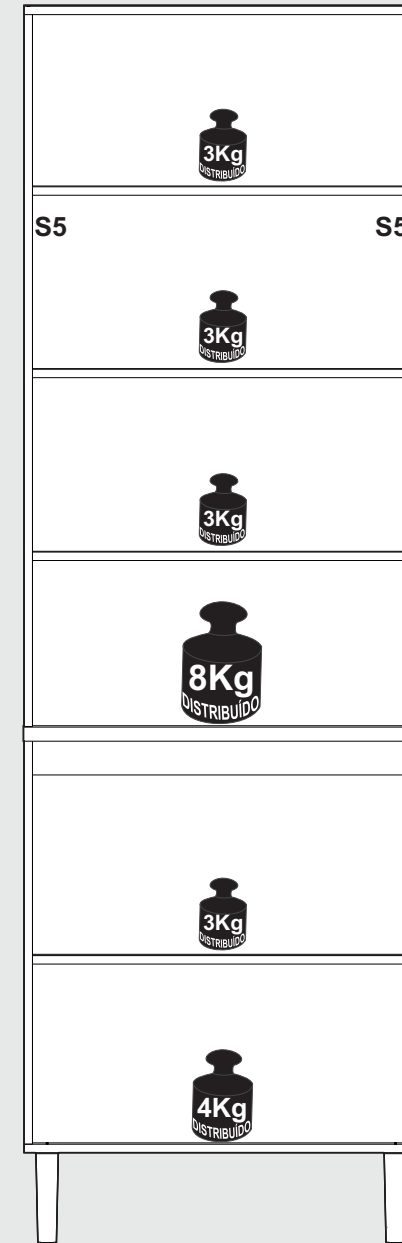
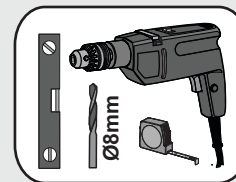
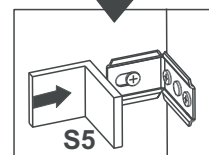
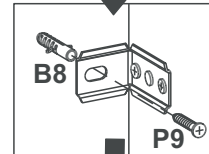
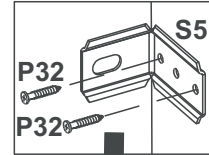

CO7220 - CRISTALEIRA 0,7 M

Manual de Montagem
Assembly Instructions
Instrucción de Montaje

decibal[®]
móveis

10°

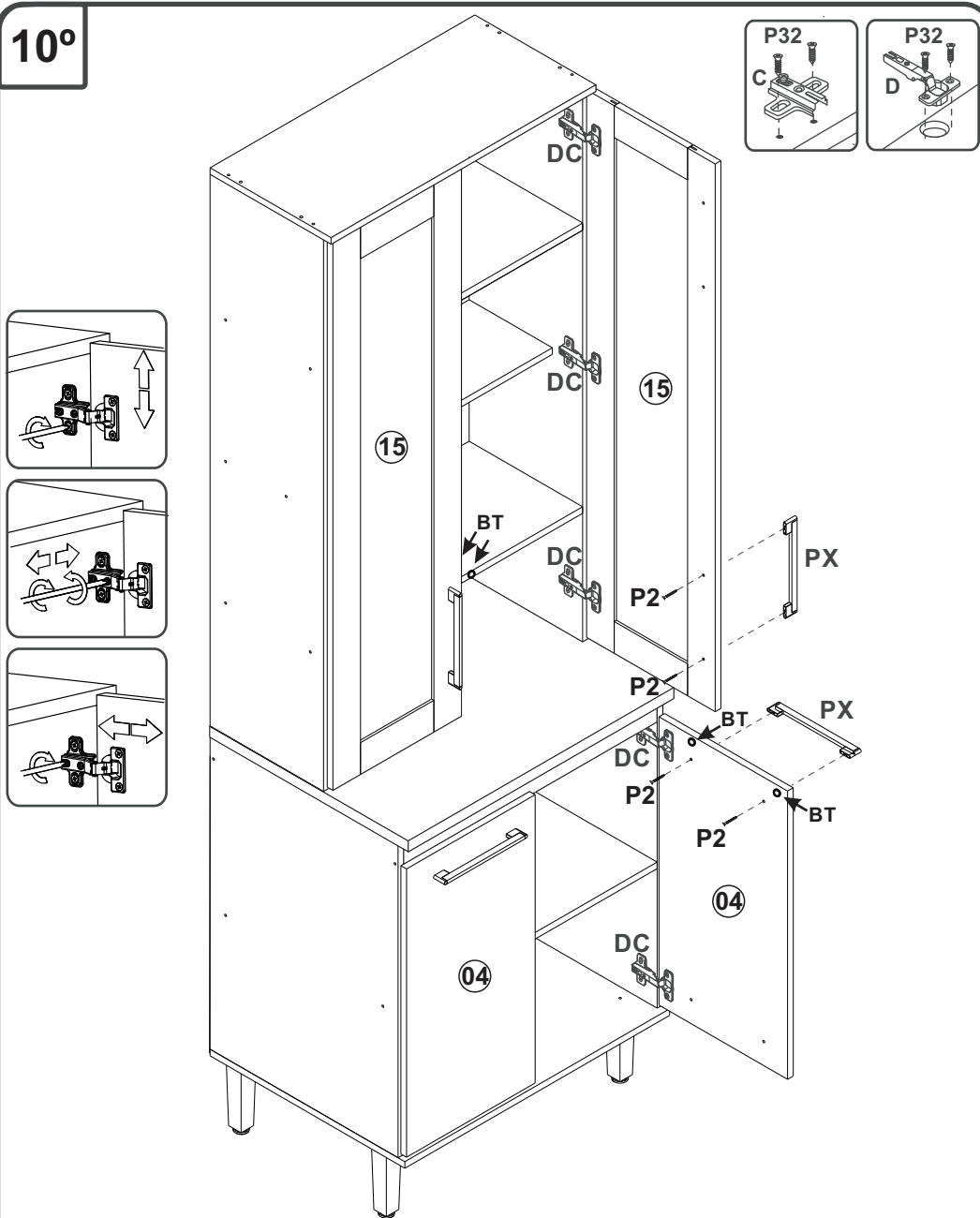

Relação de Peças/ Relación de Piezas/Parts List

N°	CÓDIGO/ CODE	DESCRIÇÃO/ DESCRIPCIÓN/ DESCRIPTION	QTD/ CANT	VOL.
1	0569160	TAMPO/TAPA/TOP	700X525X25MM	1
2	0541431	PRATELEIRA SUP/ESTANTE/SHELF	670X300X15MM	2
3	0569245	PRATELEIRA MEIO SUP/ ESTANTE/SHELF	670X220X15MM	1
4	0569157	PORTA/PUERTA/DOOR	660X340X15MM	2
5	0569162	TAMPO SUPERIOR/TAPA/TOP	700X320X15MM	1
6	0569155	TRAVESSA FRT/TRAVIESSA/TRVERSE	670X60X15MM	1
7	0569166	TARVESSA TRAZ/TRAVIESSA/TRVERSE	670X60X15MM	1
8	0569163	LATERAL DIR INF/LATERAL/SIDE	715X497X15MM	1
9	0569156	PRATELEIRA MAIOR/ESTANTE/SHELF	670X497X15MM	1
10	0569164	LATERAL ESQ INF/LATERAL/SIDE	715X497X15MM	1
11	0569154	BASE	700X515X15MM	1
12	0569158	COSTA MAIOR/REVÉS/BACK	694X340X2, 8MM	2
13	0569169	COSTA MENOR/REVÉS/BACK	694X324X2, 8MM	4
14	0569161	LATERAL DIR/LATERAL/SIDE	1263X300X15MM	1
15	0569170	PORTA DE VIDRO/PUERTA/DOOR	1254X340X15MM	2
16	0569165	LATERAL ESQ/LATERAL/SIDE	1263X300X15MM	1

Escala (N/A)

LEGENDA	DESCRIÇÃO/ DESCRIPCIÓN/ DESCRIPTION	CÓDIGO	QUANT.
PX	PUXADOR/PEGADOR /HANDLE SEVILHA NEW GOLD 192 MM	13106	04
PE	PÉ/PATA/FOOT (170MM)	12003 Champagne	04

ATENÇÃO!!!! montadores e consumidores

- * Para limpar o móveis utilize somente um pano úmido (umedecido em água pura ou água com sabão neutro). Depois, passe um pano seco. Evite a umidade excessiva.
- * Evite usar álcool, água sanitária, detergente e outros produtos químicos, mesmo diluídos em água.
- * Não utilize produtos abrasivos de nenhuma espécie

ATENCIÓN!!!! montadores e consumidores

- * Para limpiar el mueble utilice solamente un paño húmedo (humedecido con agua limpia o con un jabón suave). A continuación, utilice un paño seco. Evite el exceso de humedad.
- * Evite uso de alcohol, hipoclorido solución basada, detergente y otros productos químicos, mismo diluídos en agua. No utilice productos abrasivos de ningún tipo.





















ATTENTION!!!! assemblers and consumers

- *To clean the furniture, use only a damp cloth (humidify it only in pure water ou water and neutral soap). After, use a dry cloth. Avoid excessive humidity.
- *Avoid using alcohol, bleach, detergent and other chemical products, even diluted in water. Do not use any kind of abrasive cleaning agents to clean the furniture.
- The use of such products may jeopardize the ?nal characteristics of the furniture.

CO7220 - CRISTALEIRA 0,7 M

Manual de Montagem
Assembly Instructions
Instrucción de Montaje



Escala (1:1) Ferragens/ Herrajes/ Hardware				Escala (N/A)			
LEGENDA	DESCRIÇÃO/DESCRIPCIÓN/DESCRIPTION	CÓDIGO	QUANT.	LEGENDA	DESCRIÇÃO/DESCRIPCIÓN/DESCRIPTION	CÓDIGO	QUANT.
P1	 PARAFUSO/TORNILLO/SCREW 3X12	01328	05	CL	 COLA/PEGAMENTO/GLUE	01213	01
P2	 PARAFUSO/TORNILLO/SCREW 3,5X25	03130	08	ET	 ETIQUETA LOGO DECIBAL/LABEL DECIBAL	01312	01
P7	 PARAFUSO/TORNILLO/SCREW 4X45	01318	28	B8	 BUCHA/BUJE/BUCHING (8mm)	01311	02
P8	 PARAFUSO/TORNILLO/SCREW 5X45	01320	04	S5	 SUPORTE AÉREO/APOYO AÉREO/AIR SUPPORT	03828	02
P9	 PARAFUSO/TORNILLO/SCREW 6X50	03827	02	FX	 FIXADOR COSTA/FIJADOR FONDO/FIXER COAST	01331	24
P11	 PARAFUSO/TORNILLO/SCREW 4,5X60	08123	04	AD	 ADESIVO/ADHESIVO/ADHESIVE	15mm	20
P32	 PARAFUSO/TORNILLO/SCREW 4X14	12412	80	BT	 BATENTE/BATIENTE DE SILICONA/SILICONE STOP 8MM	02921	06
C2	 CAVILHA/TARUGO/DOWEL 6X30 MM	01211	36	DC	 DOBRADIÇA/BISAGRA/HINGE D=35mm C= Alta	12615 (Amortecimento)	10
PU	 PARAFUSO UNIÃO/UNIÓN DETORNILLO /SCREW UNION	01495	02	Ct1	 CANTONEIRA/PIEZA L/SHEET	03077	08
PR1	 PREGO/CLAVO/NAIL 10X10	01330	100	B	 BUCHA/BUJE/BUCHING	02734	04

Medida em mm

