

INSTRUÇÕES DE MONTAGEM

Cristaleira Lady 2 Portas

Referência/Cor

- CE230-05 Branco HP
- CE230-23 Duna
- CE230-40 Cristal
- CE230-129 OFF White/Nature

Requisitos para montagem

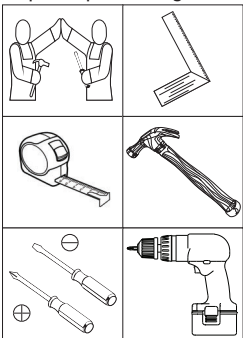

Imagens meramente ilustrativas

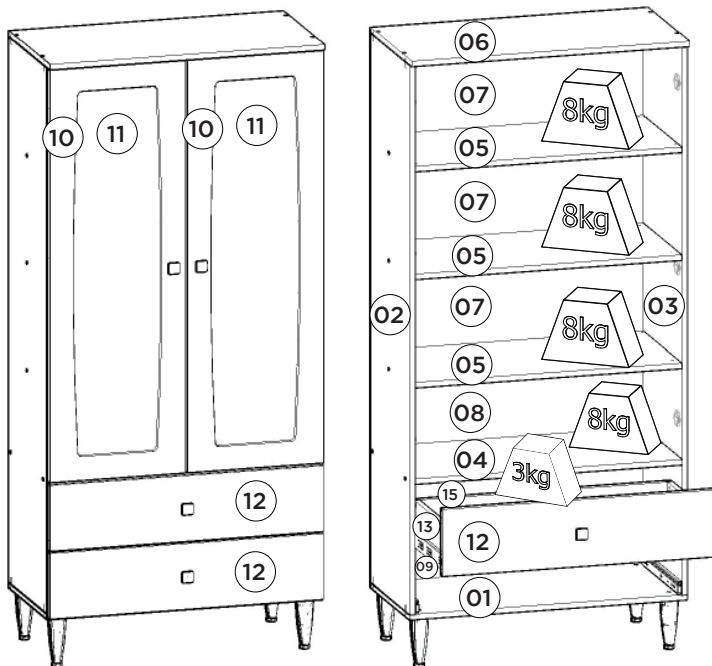

Pesos máximos recomendados com carga distribuída.

Lista de Peças

Item	Caixa	Qtd	Descrição	Medidas (mm)
01	1/1	01	Base	800x380x15
02	1/1	01	Lateral esquerda	1575x380x15
03	1/1	01	Lateral direita	1575x380x15
04	1/1	01	Tampo das Gavetas	769x380x15
05	1/1	03	Prateleira	769x375x15
06	1/1	01	Tampo	800x400x15
07	1/1	03	Fundo	792x308x3
08	1/1	01	Fundo Menor	792x274x3
09	1/1	01	Fundo Cru	792x394x3
10	1/1	02	Porta	1189x396x15
11	1/1	02	Vidro	1090x290x3
12	1/1	02	Frente de gaveta	795x192x15
13	1/1	04	Lado de gaveta	350x110x15
14	1/1	02	Fundo de Gaveta	725x361x3
15	1/1	02	Ripa de trás	744x110x15

RECOMENDAÇÃO

Para fixar o móvel na parede usar o suporte de fixação (V), o parafuso 3,5x14mm FLA (F), a Bucha 8mm (W) e o parafuso 5,0x50mm FLA (B).

AVISO

Para limpeza de seu móvel, use uma flanela seca ou umedecida, e não utilize produtos químicos que possam danificar seu produto.

SISTEMA DE MONTAGEM

O sistema de montagem dos produtos, funciona de acordo com a ordem crescente dos números indicados no desenho. Ex: 01, 02, 03, 04... até a conclusão da montagem.

Ferragens

A 04x	B 01x	C 04x	D 14x	E 04x	F 26x	G 48x	H 04x
Parafuso 7,0x40mm CHT.	Parafuso 5,0x50mm FLA.	Parafuso 4,5x50mm CHT.	Parafuso 3,5x40mm CHT.	Parafuso 3,5x25mm FLA.	Parafuso 3,5x14mm FLA.	Parafuso 3,5x12mm CHT.	Parafuso 3,0x30mm CHT.
I 04x	J 38x	K 04x	L 76x	M 28x	N 04x	O 04x	P 04x
Parafuso 3,0x16mm CHT.	Cavilha 8x25mm	Cantoneira plástica	Prego 10x10mm	Fixador de fundos	Cantoneira suporte triangular	Porca cilíndrica	Pé Cônico 145mm
Q 06x	R 06x	S 02x	T 04x	U 16x	V 01x	W 01x	X 01x
Calço metal médio 0mm	Dobradilha metal 35mm Colo Baixo	Corrediça telescópica	Puxador Pontual STUB ONYX UV	Suporte fixação de vidro	Suporte de fixação	Bucha plástica 8mm	Proteção para cantoneira
Y 02x	Z 04x	AA 02x	AB 10x				
Giz de correção	Batente PVC para Porta	Sachê de cola	Adesivo tapa parafuso 10mm				

1º

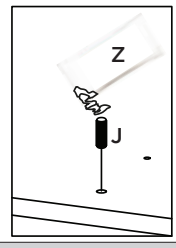
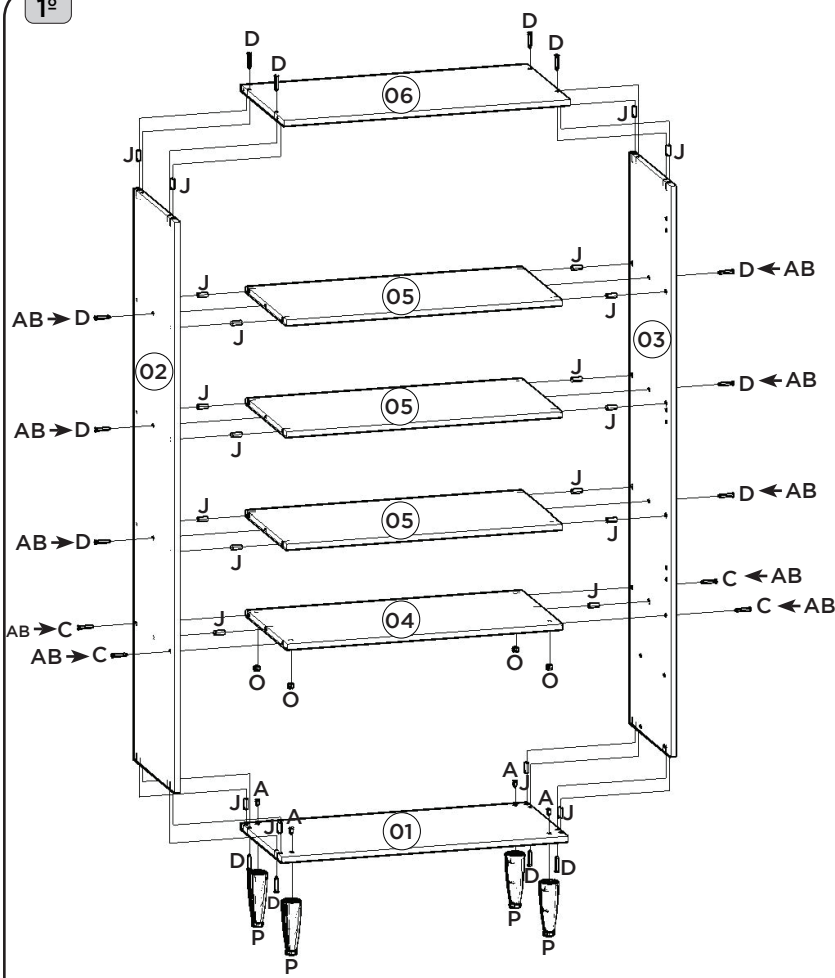

Utilizar o sachê de cola (Z) em todas as cavilhas (J) do produto.

2º

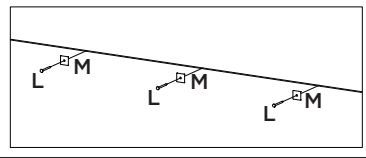
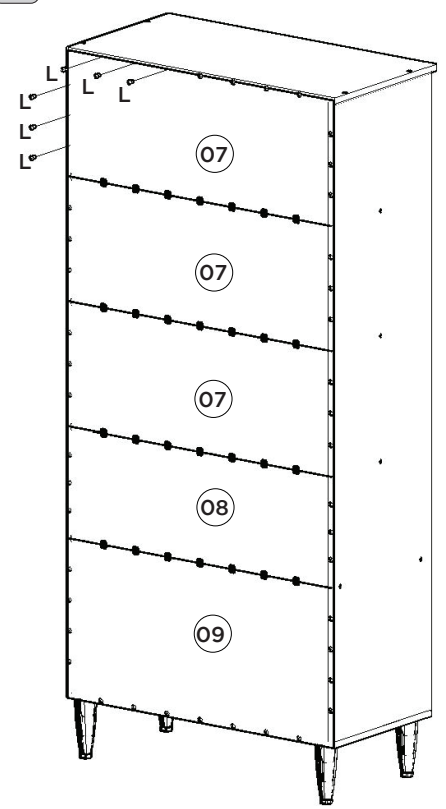

3º

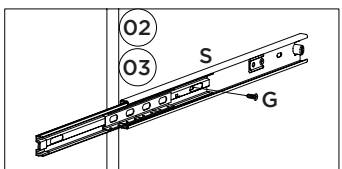
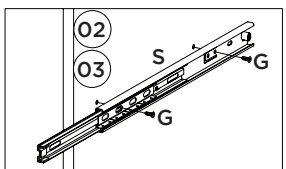
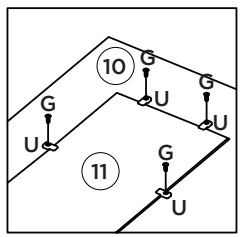
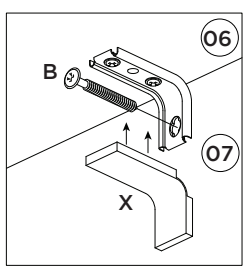
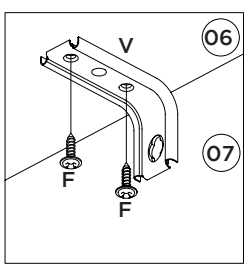
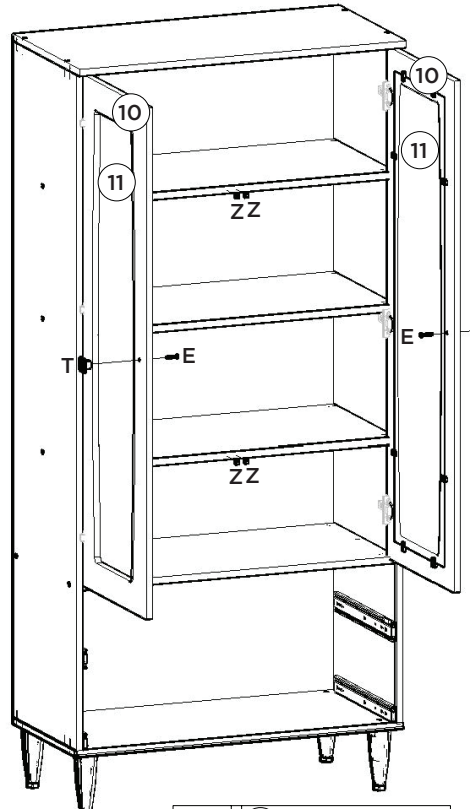
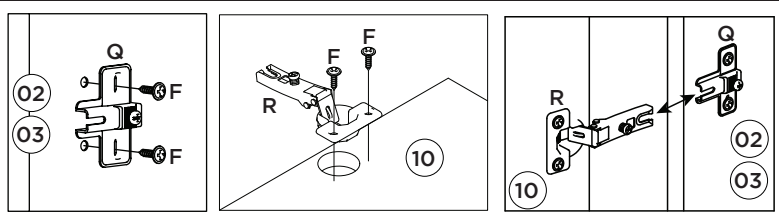

4º

