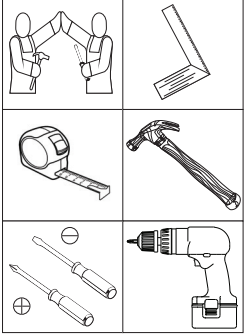
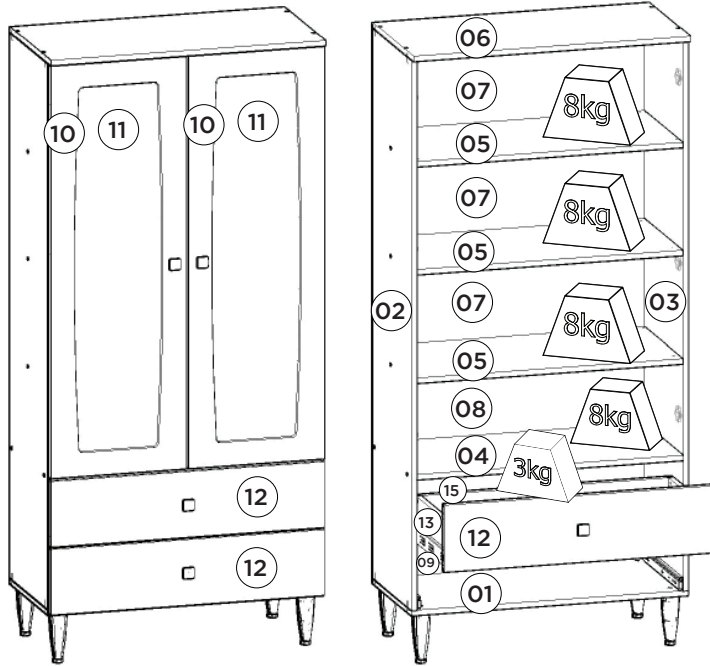

**HENN**Ind. e Com. de Móveis Henn  
Mondai - SC - Brasil

☎ +55 49 3674.3500

📱 @moveishenn  
www.henn.com.br**INSTRUÇÕES DE MONTAGEM****INSTRUCCIONES DE MONTAJE**  
**ASSEMBLY INSTRUCTIONS**Vídeo de Montagem  
Video de montaje  
Assembly Video**Cristaleira 2 Portas Liz | Gabinete 2 Puertas Liz | Cabinet 2 Doors Liz****Referência/Cor**

- C230-05 Branco HP
- C230-23 Duna
- C230-40 Cristal

Requisitos para montagem  
Requisitos para la montaje  
Assembly RequirementsImagens meramente ilustrativas  
Imágenes meramente ilustrativas  
Images for illustration only

Pesos máximos recomendados com carga distribuída  
Peso máximo recomendado con la carga distribuida  
Recommended maximum weight with distributed load.

**AVISO**  
Para limpeza de seu móvel, use uma flanela seca ou umedecida, e não utilize produtos químicos que possam danificar seu produto.

**SISTEMA DE MONTAGEM**  
O sistema de montagem dos produtos, funciona de acordo com a ordem crescente dos números indicados no desenho. Ex: 01, 02, 03, 04... até a conclusão da montagem.

**ADVERTENCIA**  
Para limpieza de su móvil, use una flanela seca o húmeda, y no utilice productos químicos que puedan dañar su producto.

**SISTEMA DE MONTAJE**  
El sistema de montaje de los productos funciona de acuerdo con el orden creciente de los números indicados en el dibujo. Ej.: 01, 02, 03, 04... hasta la conclusión del montaje.

**NOTICE**  
To clean your furniture, use a dry or wet cloth, and do not use chemicals that may damage your product.

**ASSEMBLY SYSTEM**  
The products' assembly system works according to the increasing order of the indicated numbers. For example: 01, 02, 03, 04 ... to the end of the assembly.

**Lista de Peças | Lista de piezas | List of parts**

Item	Caixa Caja Box	Qtd Ctd Qty	Descrição   Descripción   Description	Medidas (mm)   Dimensions (mm)   Size (measurements) (mm)
01	1/1	01	Base   Base   Base	800x380x15
02	1/1	01	Lateral esquerda   Lateral izquierda   Left side	1575x380x15
03	1/1	01	Lateral direita   Lateral derecha   Right side	1575x380x15
04	1/1	01	Tampo das Gavetas   Tapa de los cajones   Drawer Top	769x380x15
05	1/1	03	Prateleira   Estante   Shelf	769x375x15
06	1/1	01	Tampo   Tapa   Top	800x400x15
07	1/1	03	Fundo   Fondo   Bottom	792x308x3
08	1/1	01	Fundo Menor   Fondo Menor   Minor Fund	792x274x3
09	1/1	01	Fundo Cru   Fondo Cru   Raw Background	792x394x3
10	1/1	02	Porta   Puerta   Door	1189x396x15
11	1/1	02	Vidro   Vidrio   Glass	1090x290x3
12	1/1	02	Fronte de gaveta   Frente de cajón   Front of drawer	795x192x15
13	1/1	04	Lado de gaveta   Lado del cajón   Side of drawer	350x110x15
14	1/1	02	Fundo de Gaveta   Fondo del Cajón   Drawer Background	725x361x3
15	1/1	02	Ripa de trás   Malla detrás   Rear lath	744x110x15

**RECOMENDAÇÃO**

Para fixar o móvel na parede usar o suporte de fixação (V), o parafuso 3,5x14mm FLA (F), a Bucha 8mm (W) e o parafuso 5,0x50mm FLA (B).

**RECOMENDACIÓN**

Para conectar el móvil a la pared con el soporte (V), tornillo 3,5 x14mm FLA (F), el casquillo de 8 mm (W) y el 5,0 x50mm tornillo FLA (B).

**RECOMMENDATION**

To fix the furniture to the wall use the fixing bracket (V), the 3.5x14mm FLA (F) screw, the 8mm bushing (W) and the 5.0x50mm FLA screw (B).

**Ferragens | Herrajes | Hardware**

<b>A</b> 04x Parafuso 7,0x40mm CHT. Tornillo 7,0x40mm CHT. Screw 7,0x40mm CHT.	<b>B</b> 01x Parafuso 5,0x50mm FLA. Tornillo 5,0x50mm FLA. Screw 5,0x50mm FLA.	<b>C</b> 04x Parafuso 4,5x50mm CHT. Tornillo 4,5x50mm CHT. Screw 4,5x50mm CHT.	<b>D</b> 14x Parafuso 3,5x40mm CHT. Tornillo 3,5x40mm CHT. Screw 3,5x40mm CHT.	<b>E</b> 04x Parafuso 3,5x25mm FLA. Tornillo 3,5x25mm FLA. Screw 3,5x25mm FLA.	<b>F</b> 26x Parafuso 3,5x14mm FLA. Tornillo 3,5x14mm FLA. Screw 3,5x14mm FLA.	<b>G</b> 48x Parafuso 3,5x12mm CHT. Tornillo 3,5x12mm CHT. Screw 3,5x12mm CHT.	<b>H</b> 04x Parafuso 3,0x30mm CHT. Tornillo 3,0x30mm CHT. Screw 3,0x30mm CHT.
<b>I</b> 04x Parafuso 3,0x16mm CHT. Tornillo 3,0x16mm CHT. Screw 3,0x16mm CHT.	<b>J</b> 38x Cavilha 8x25mm Cinto 8x25mm Dowel 8x25mm	<b>K</b> 04x Cantoneira plástica Cantонера plástica Plastic angle brackets	<b>L</b> 76x Prego 10x10mm Clavo 10x10mm Nail 10x10mm	<b>M</b> 28x Fixador de fundos Fijador de fondos Bottom fixer	<b>N</b> 04x Cantoneira suporte triangular Cantонера soporte triangular Triangle support angle	<b>O</b> 04x Porca cilíndrica Tuercas cilíndricas Cylindrical nut	<b>P</b> 04x Pé Cônico 145mm Pie Cónico 145mm Conical Foot 145mm
<b>Q</b> 06x Calço metal médio Omm Calzón de metal medio Omm Shim metal middle Omm	<b>R</b> 06x Dobradiça metal 35mm Colo Baixo Bisagra de metal 35mm Colo Bajo Metal hinge 35mm Colo Low	<b>S</b> 02x Corrediça telescópica Corredera telescópica Telescopic slide	<b>T</b> 04x Puxador Pontual STUB ONYX UV Tirador Puntual STUB ONYX UV STUB ONYX UV Spot Knob	<b>U</b> 16x Suporte fixação de vidro Soporte de fijación de cristal Glass fixing bracket	<b>V</b> 01x Suporte de fixação Soporte de fijación Mounting bracket	<b>W</b> 01x Bucha plástica 8mm Bucha de plástico 8mm 8mm plastic bushing	<b>X</b> 01x Proteção para cantoneira Ángulo de protección Protection angle
<b>Y</b> 02x Giz de correção Tiza de corrección Chalk of correction	<b>Z</b> 04x Batente PVC para Porta Parada de PVC para Puerta PVC Door Stop	<b>AA</b> 01x <b>HENN</b> Etiqueta resinada Henn Etiqueta resinada Henn Henn resin label	<b>AB</b> 10x Adesivo tapa parafuso 10mm Adhesivo tapón de tornillo 10mm Bolt cover adhesive 10mm	<b>AC</b> 02x Sachê de cola Bolsa de pegamento Glue bag			

1º

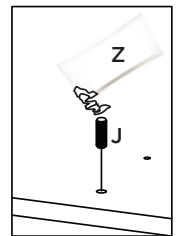
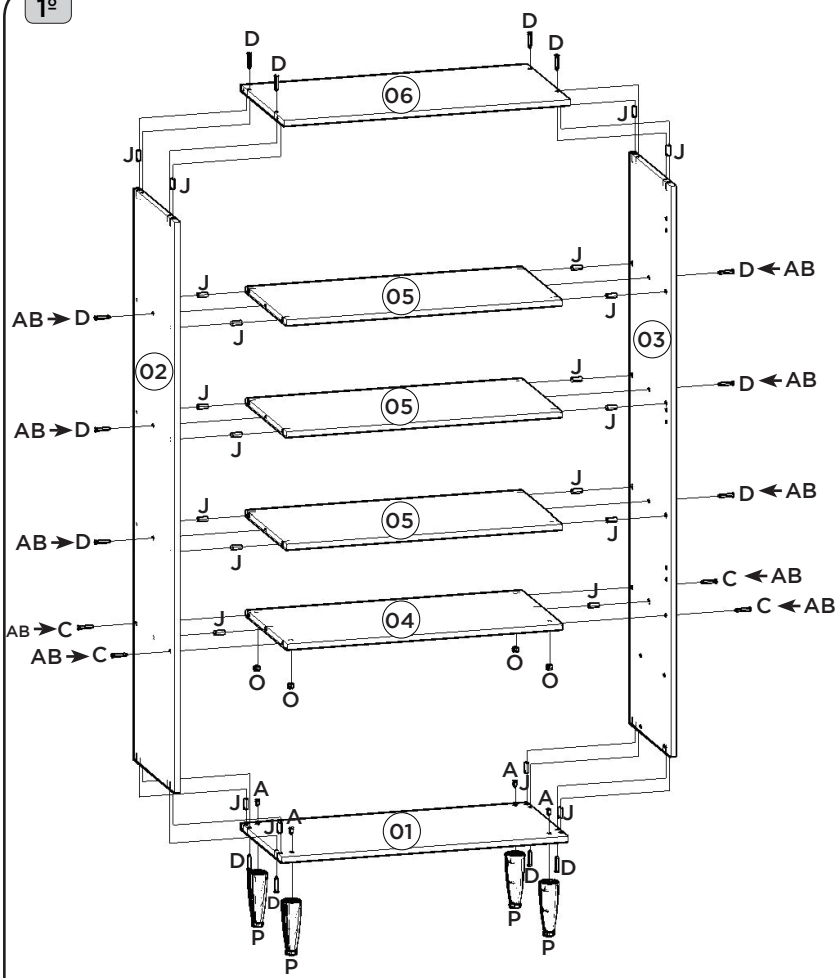

Utilizar o sachê de cola (Z) em todas as cavilhas (J) do produto.

Con el pegamento sobre (Z) en todos los pernos (J) producto.

Use the glue sachet (Z) on all the pegs (J) of the product.

2º

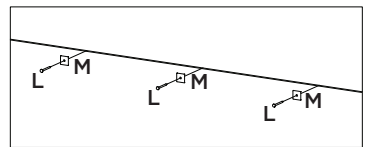
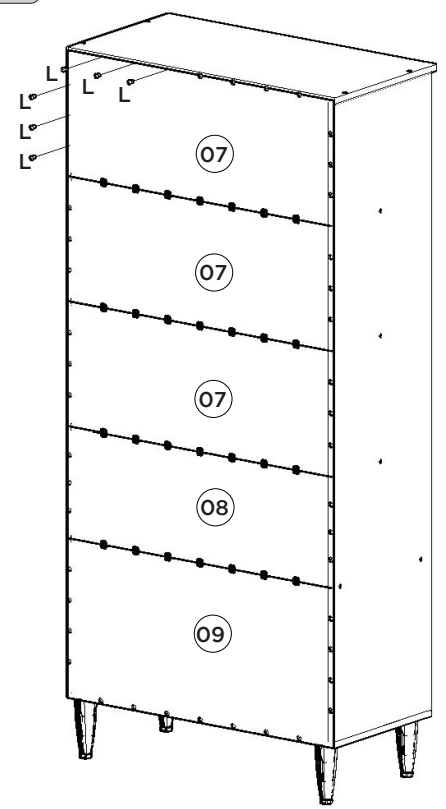

3º

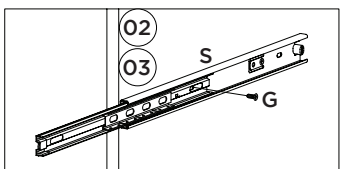
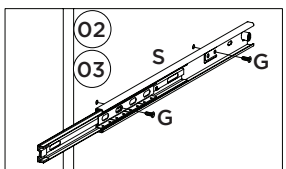
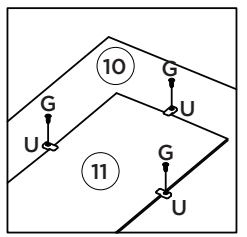
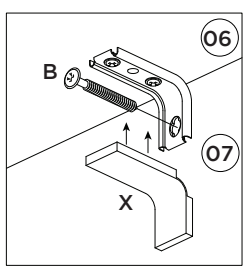
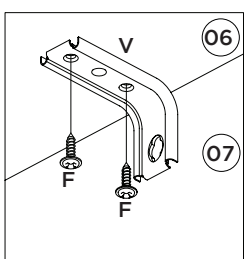
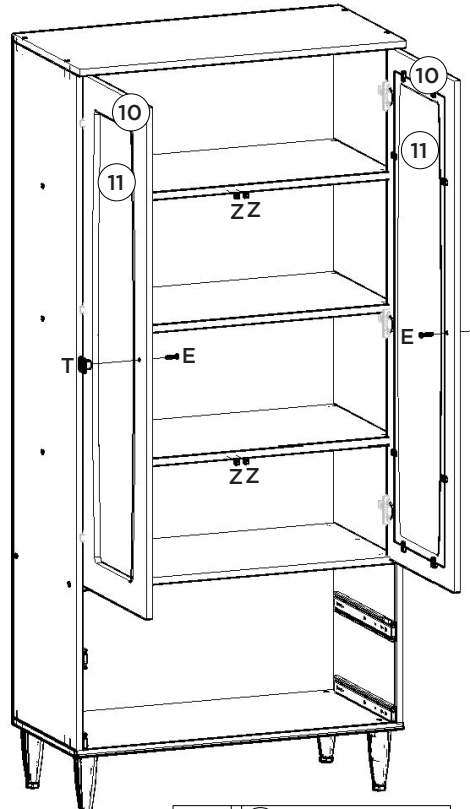
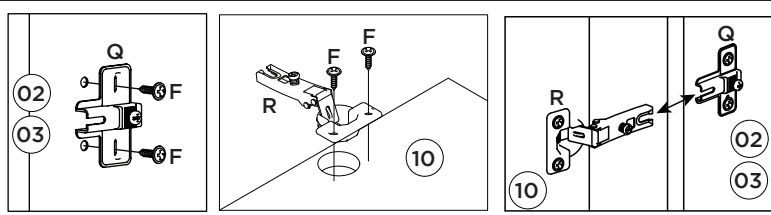

4º

