

# Armário Tamburato com Nicho Linha Executiva

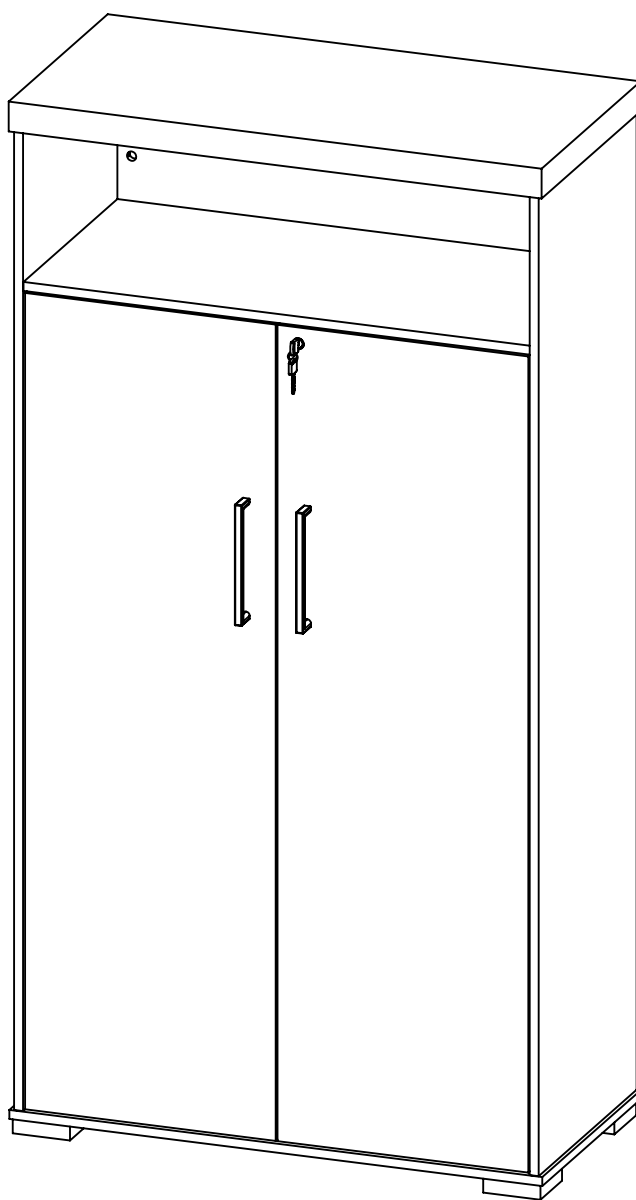

- Siga atentamente todas as instruções de montagem;
- Monte seu produto no local ou próximo de onde será colocado. Movimentações do produto já montado, podem avariá-lo;
- Faça a montagem em uma superfície limpa e plana. Aconselhamos usar a própria embalagem de papelão para forrar o chão;
- Verifique se as quantidades de peças e acessórios estão de acordo com o manual de montagem;
- Compare atentamente os furos de cada peça com a ilustração do manual;
- Utilize as ferramentas indicadas. Só utilize parafusadeira se tiver conhecimento e habilidade. O uso inapropriado pode danificar peças e/ou acessórios;
- Se o produto necessitar fixação na parede, tenha cuidado para não atingir fios e canos ao furar a parede.

**Obs:** Caso necessite solicitar peças de reposição, por favor, utilize os códigos dos mesmos.

- Siga con atención todas las instrucciones de armado.
- Arme su mueble en un lugar cerca donde será instalado. Mover el producto ya montado puede perjudicarlo.
- Haga el montaje en una superficie limpia y plana. Aconsejamos usar el propio embalaje de cartón para forrar el suelo.
- Asegúrese de que las cantidades de piezas y accesorios coincidan con el manual de montaje.
- Compare cuidadosamente los agujeros de cada pieza con la ilustración del manual.
- Utilice las herramientas indicadas. Sólo utilice atornillador automático si tiene conocimiento y habilidad. El uso inapropiado puede dañar piezas y/o accesorios.
- Si el producto necesita fijación en la pared, tenga cuidado de no alcanzar cables y tuberías al perforar la pared.

**OBS:** Si necesita solicitar piezas y / o accesorios de repuesto, por favor, utilice los códigos de los mismos.

- Follow carefully the assembly instructions.
- Assemble your furniture in a place near where it will be installed. Moving the assembled product can harm it.
- Make the assembly on a clean and flat surface. We recommend using the cardboard box to cover the floor.
- Make sure the quantities of parts and accessories match the assembly manual.
- Carefully compare the holes in each piece with the illustration in the manual.
- Use the indicated tools. Only use an automatic screwdriver if you have knowledge and skill. Improper use can damage parts and/or accessories.
- If the product needs fixing on the wall, be careful and don't reach cables and pipes when drilling the wall.

**NOTE:** If you need to request spare parts and/or accessories, please use the codes according of this instruction manual.

## CONSERVAÇÃO E LIMPEZA

### MANTENIMIENTO Y LIMPIEZA / MAINTENANCE AND CLEANING

Não expor o produto ao sol, altas temperaturas e umidade, mantendo-o em local seco e arejado. Para a limpeza, utilizar um pano seco e macio. Não é necessário o uso de materiais abrasivos ou álcool.

*No exponga el producto al sol, altas temperaturas y la humedad. Mantener en local seco y ventilado. Para limpiar, utilice un paño suave y seco. No es necesario el uso de materiales abrasivos o alcohol.*

*Do not expose the product to sunlight, high temperatures and humidity. Keep it in a dry and ventilated place. To clean it, use a soft and dry cloth. It is not necessary to use abrasive materials or alcohol.*

## Garantia

Este certificado de Garantia é uma vantagem adicional oferecida ao consumidor, porém para que o mesmo tenha validade é imprescindível que seja apresentada a NOTA FISCAL de compra do produto e o número do lote (ver etiqueta).

Com este produto, a **Artany** tem como objetivo atender plenamente o proprietário-consumidor, proporcionando a garantia na forma aqui estabelecida, pelo período de 03 meses a partir da data da nota fiscal de compra. A **Artany** restringe a sua responsabilidade à substituição gratuita das peças defeituosas, em caso de defeitos ou avarias devidamente constatados como sendo de fabricação, durante a vigência desta garantia.

A **Artany** declara a garantia nula e sem efeito se o produto for alterado, adulterado, molhado ou consertado e ainda pela prática de montagem inadequada. Também será considerada nula em casos de força maior, como aqueles causados por agentes da Natureza (chuvas, incêndios, excesso de umidade...).

Para exercer seus direitos de comprador é importante que antes de montar seu produto você leia com atenção as instruções de cada passo do manual de montagem que acompanha o móvel.

Caso o produto não esteja em conformidade, entre em contato com a loja onde efetuou a compra ou com o nosso Serviço de Atendimento ao Cliente através do fone (41) 3556 1500 ou do e-mail [assistencia@artany.com.br](mailto:assistencia@artany.com.br), e faça sua reclamação, apontando os defeitos técnicos observados, que teremos o maior prazer em atendê-lo. Para agilizar o seu atendimento, tenha sempre em mãos o manual de montagem com os respectivos números das peças defeituosas conforme descritas no manual.

FERRAMENTAS **NÃO** FORNECIDAS, MAS NECESSÁRIAS  
PARA A MONTAGEM DO PRODUTO

HERRAMIENTAS **NO** SUMINISTRADAS, PERO NECESARIAS PARA EL MONTAJE DEL PRODUCTO  
TOOLS **NOT** SUPPLIED, BUT NECESSARY FOR THE ASSEMBLY

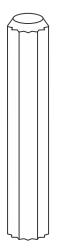

100097

12X



100070

42X



100069

42X

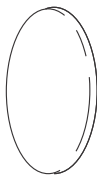

102555

18X

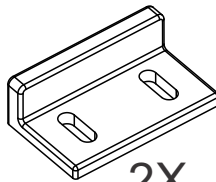

100472

2X

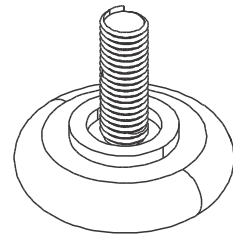

100526

4X

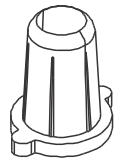

100560

4X

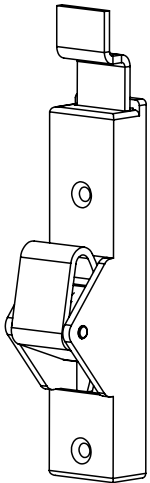

100000

1X

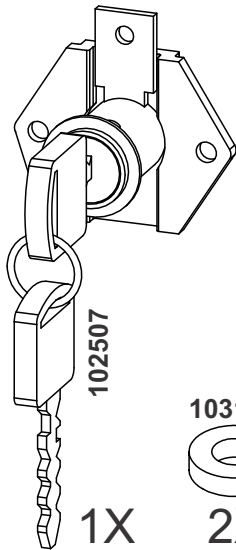

102507

1X

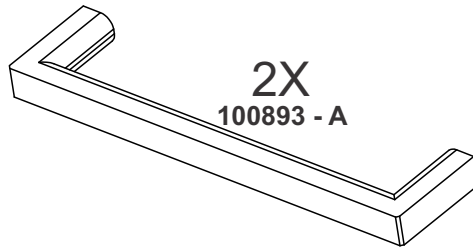

2X

100893 - A



103115

2X



100642

2X

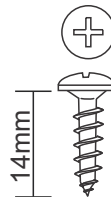

14mm

+

100234

30X

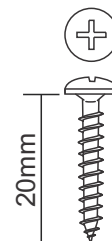

20mm

+

100254

2X



+

104679

8X



+



+

100893-B

4X

DOBRADEIRA - 104172

BISAGRA / HINGES

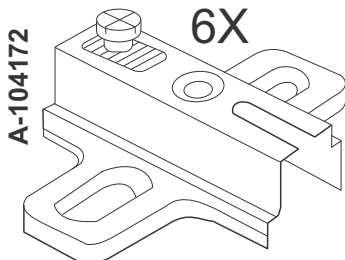

A-104172

6X

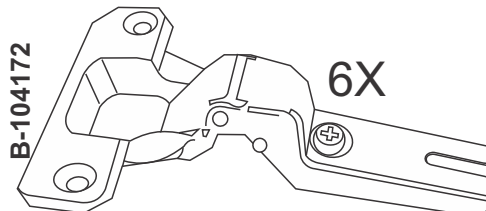

B-104172

6X

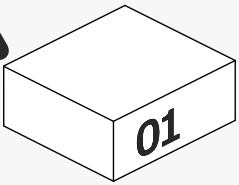

O número na borda da peça corresponde ao manual.  
Para remover, use um pano com álcool em gel ou álcool 70%.

*El número que aparece en el borde de la pieza corresponde al manual.  
Para retirarlo, utilice un paño con alcohol en gel o alcohol al 70%.*

*The number on the edge of the piece corresponds to the assembly guide.  
To remove it, use a cloth with alcohol gel or 70% alcohol.*

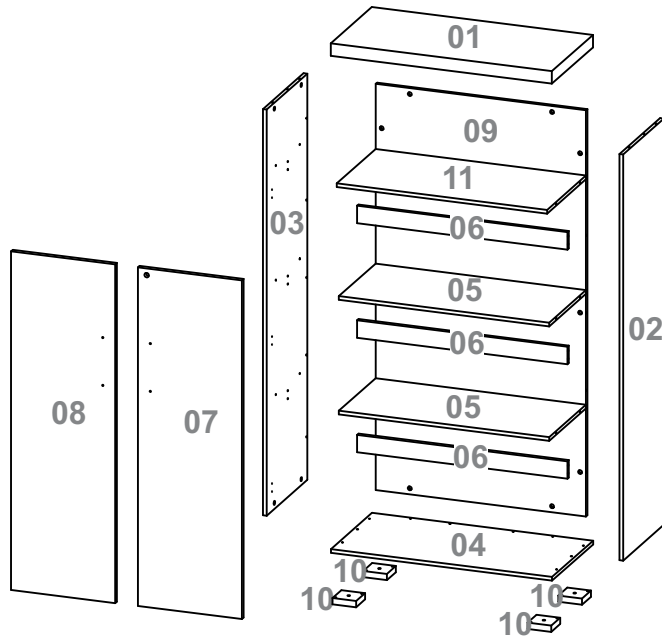

Número Número Number	Medida Dimensión Size	Quantidade Cantidad Quantity
01	895x440x50mm	01
02	1631x435x15mm	01
03	1631x435x15mm	01
04	895x440x15mm	01
05	851x395x15mm	02
06	851x70x15mm	03
07	1360x422x18mm	01
08	1360x422x18mm	01
09	1631x851x15mm	01
10	96x96x25mm	04
11	851x417x15mm	01

1

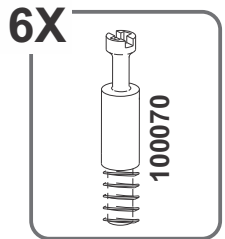
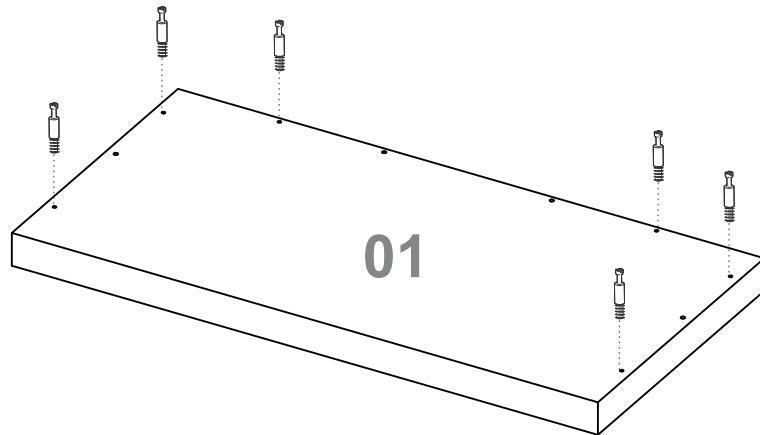

2

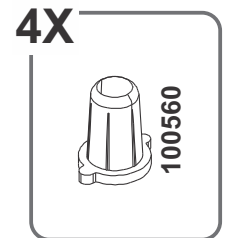
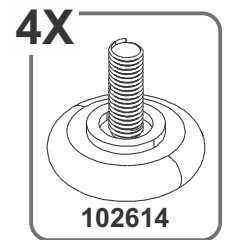
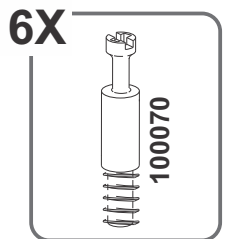
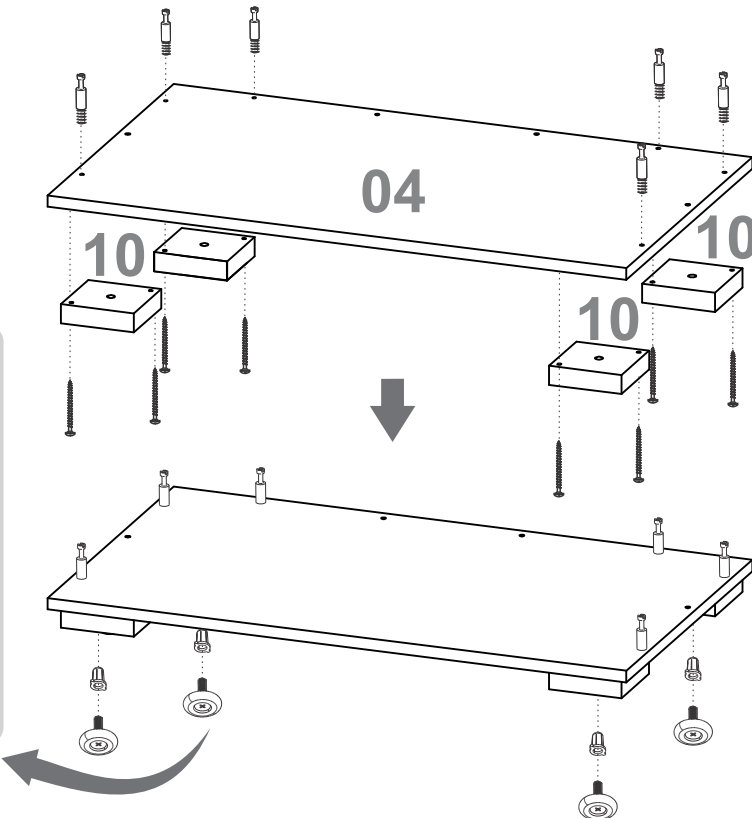
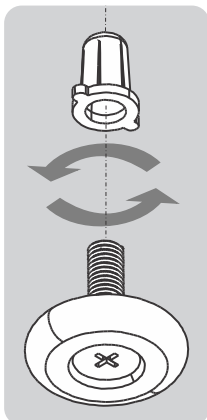
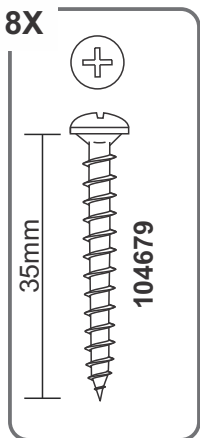

3

30X

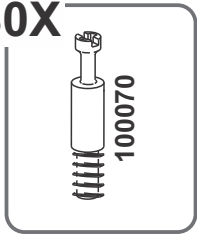

4X

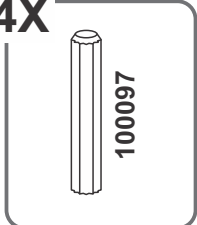

12X

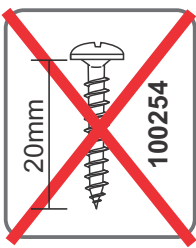

6X

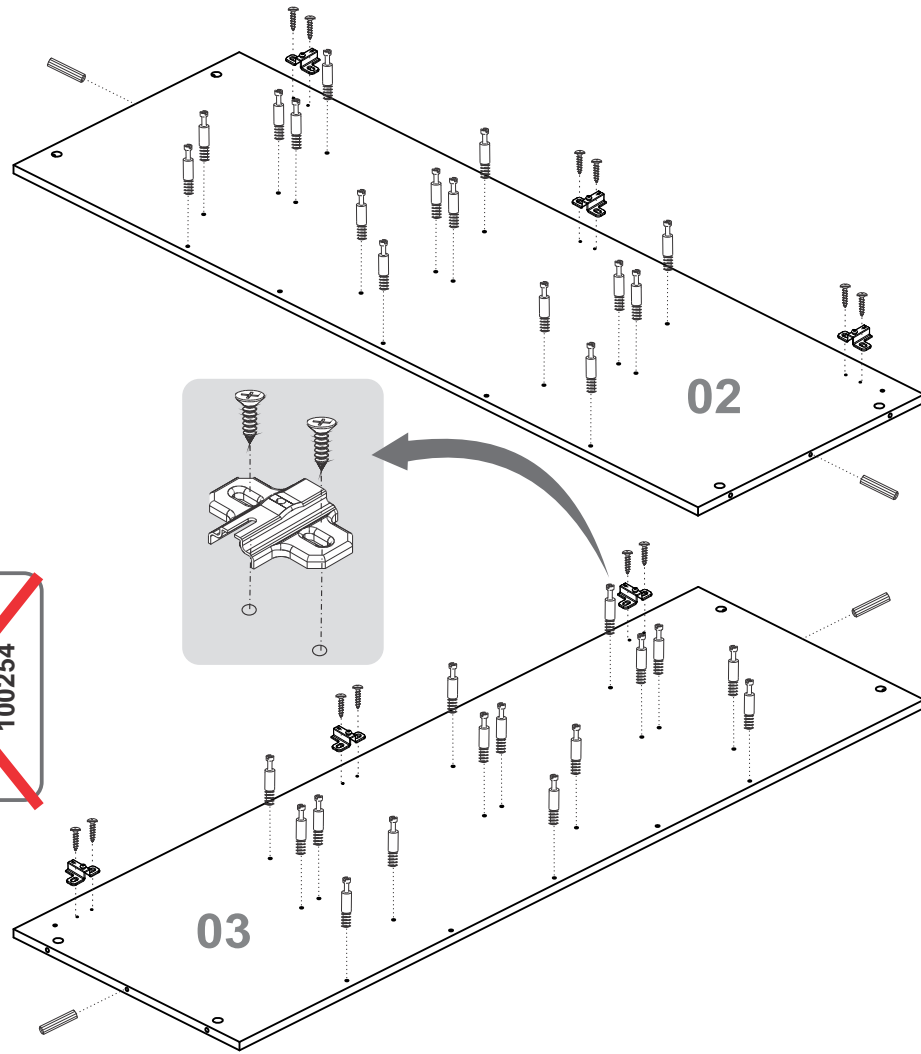
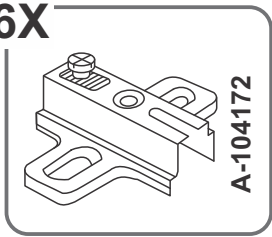

4

14X

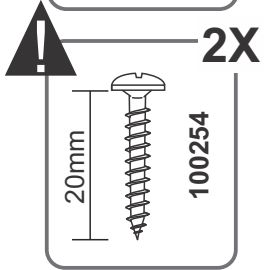
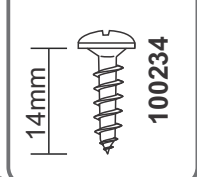

2X

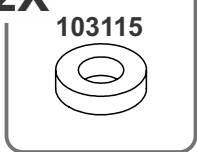

4X

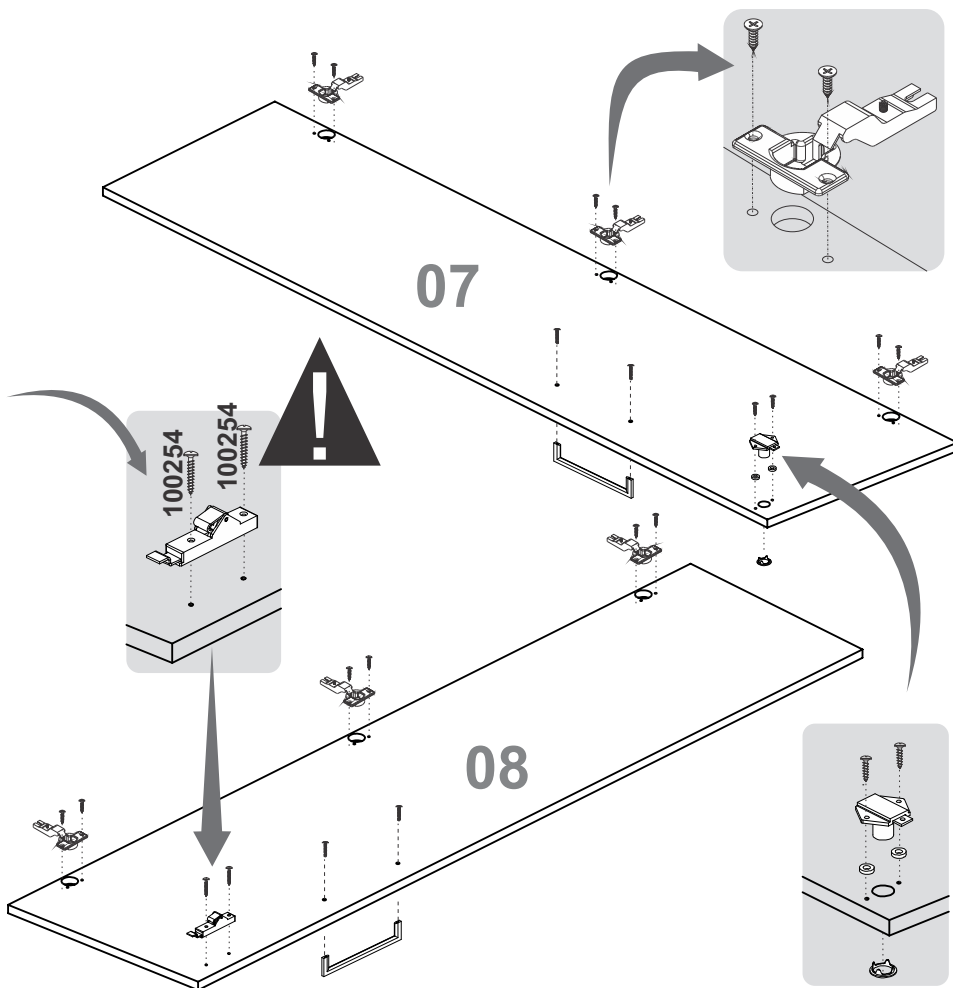
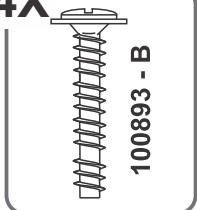

6X

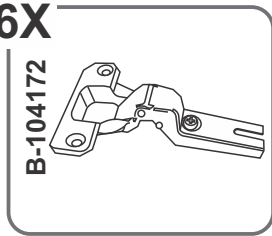

1X

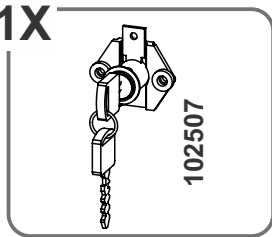

1X

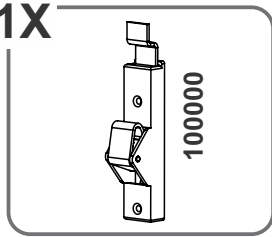

2X

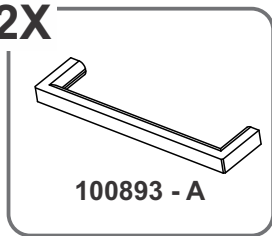

5

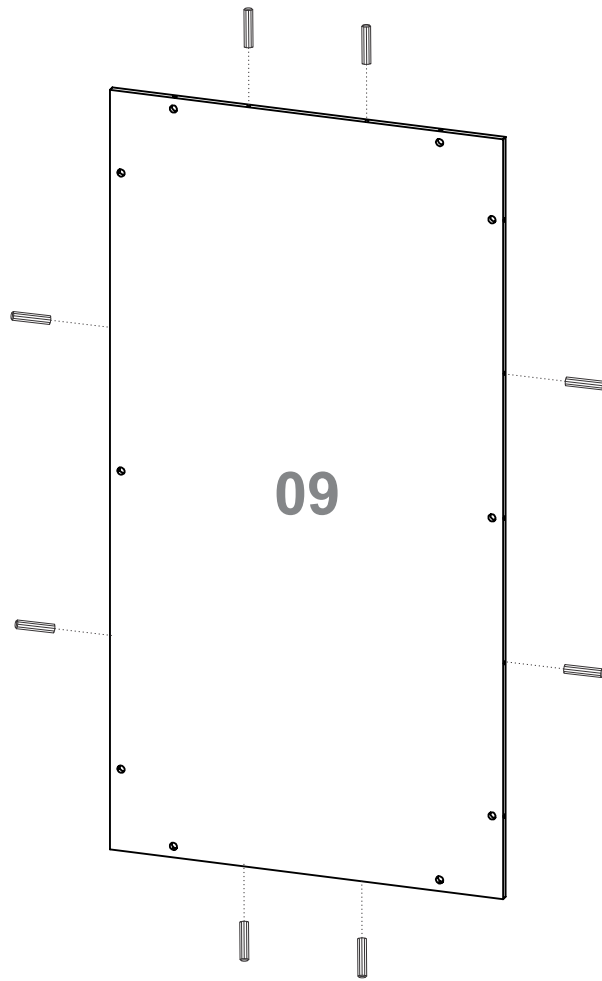

8X



6

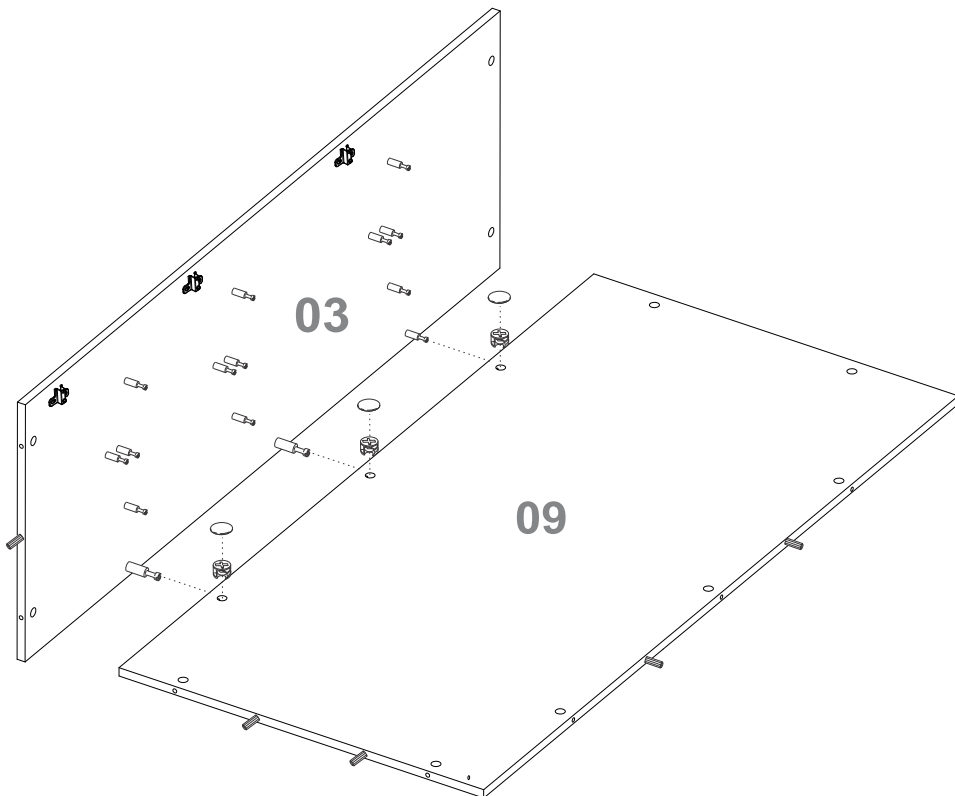

3X



100069

3X

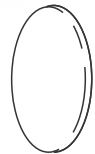

102647

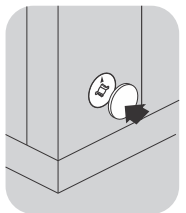
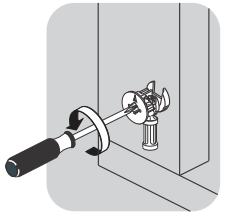
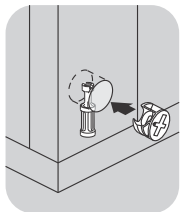

7

12X

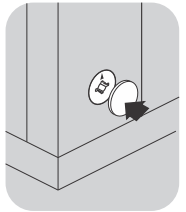
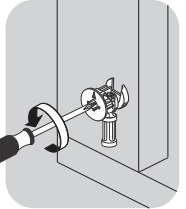
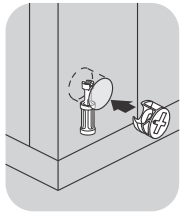
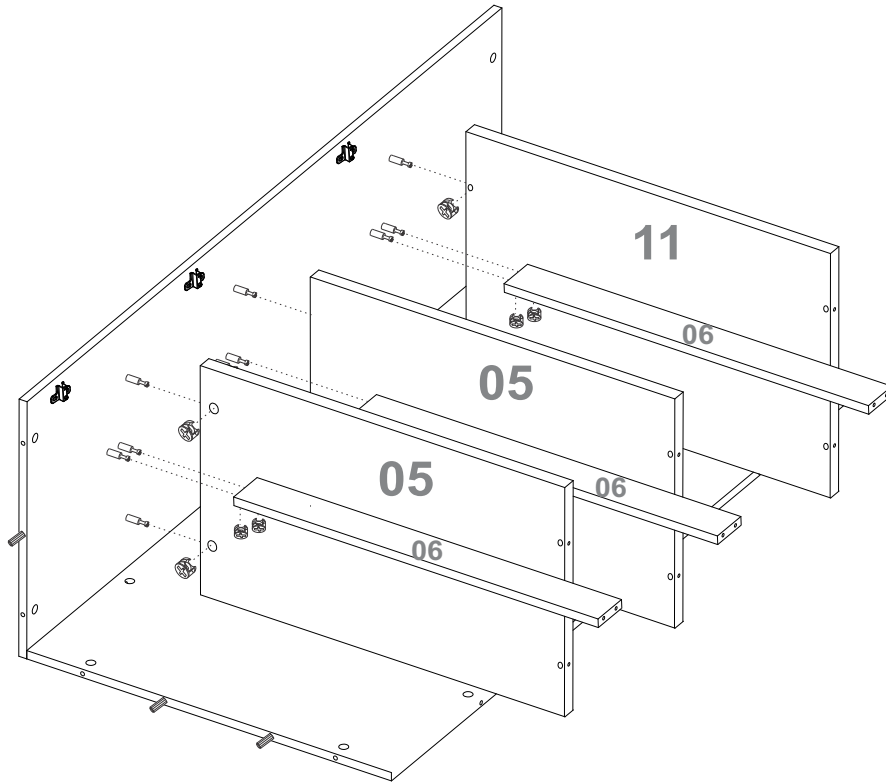
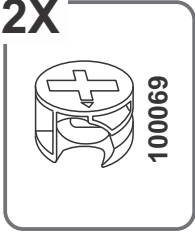

8

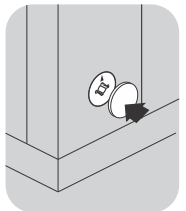
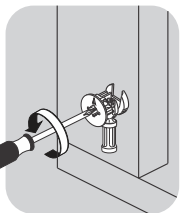
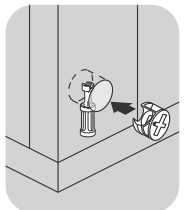
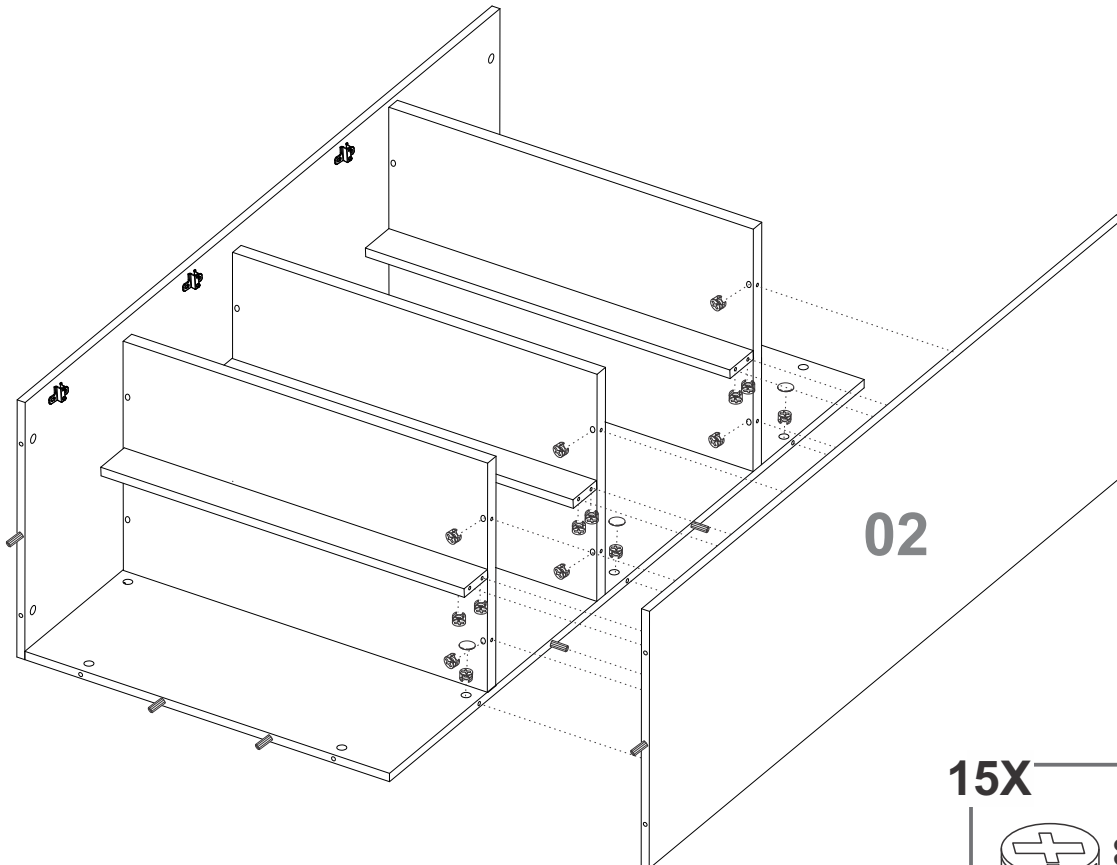

15X

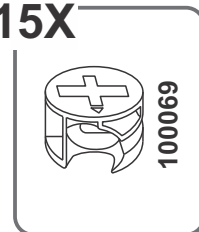

3X

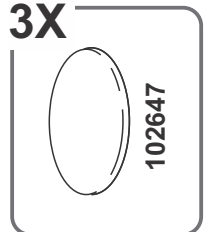

9

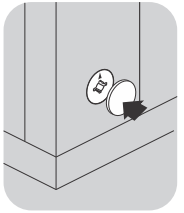
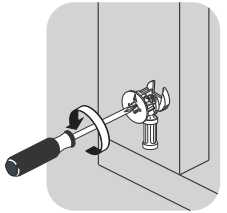
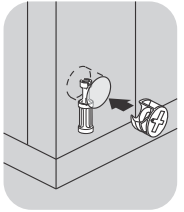
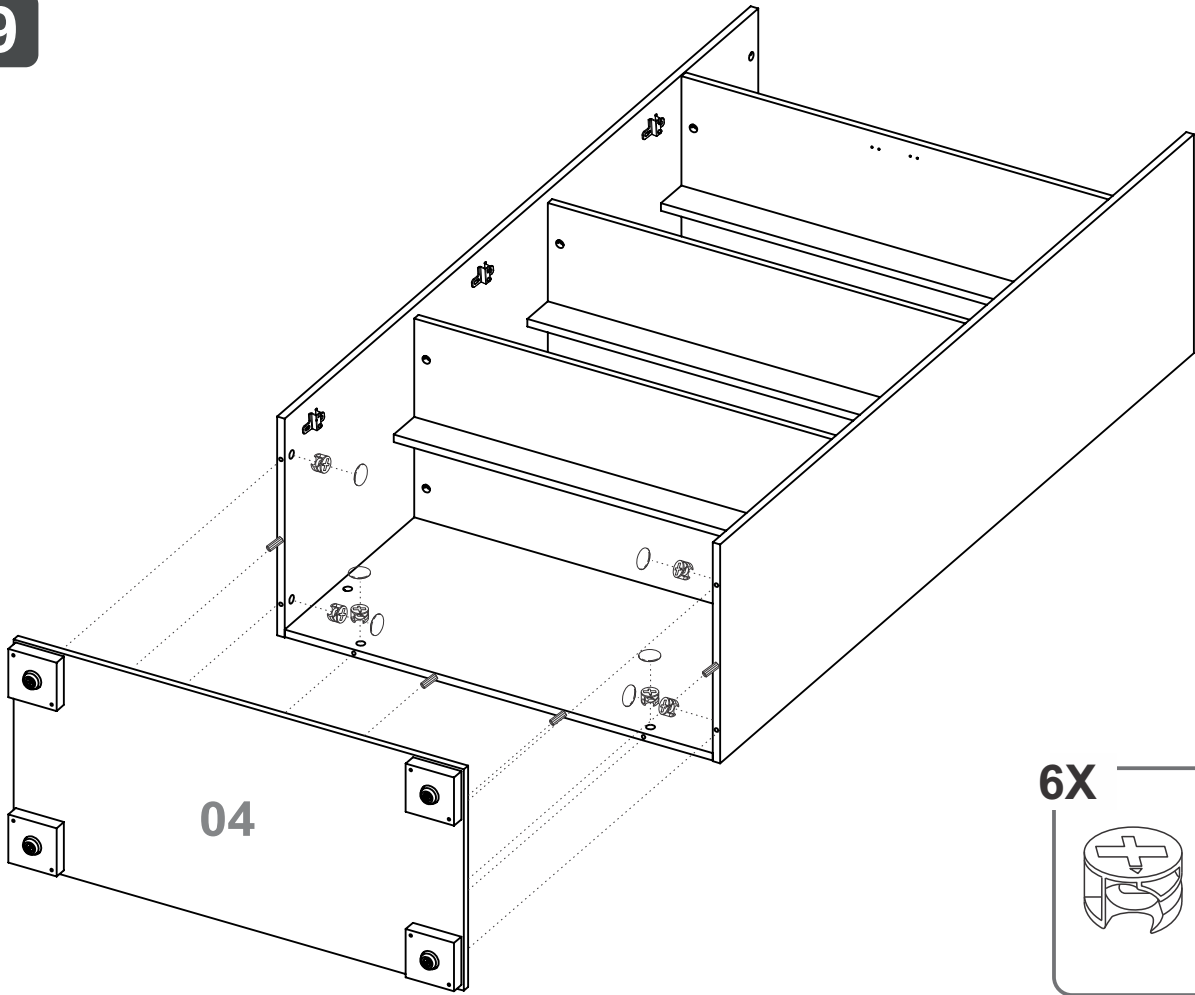

6X

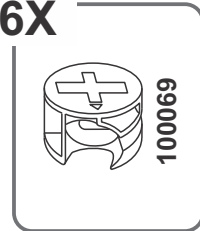

100069

6X

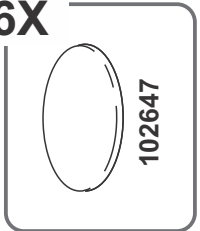

102647

10

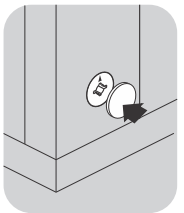
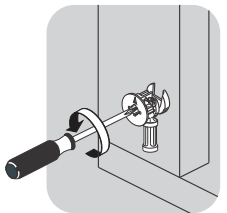
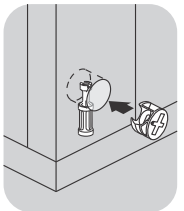
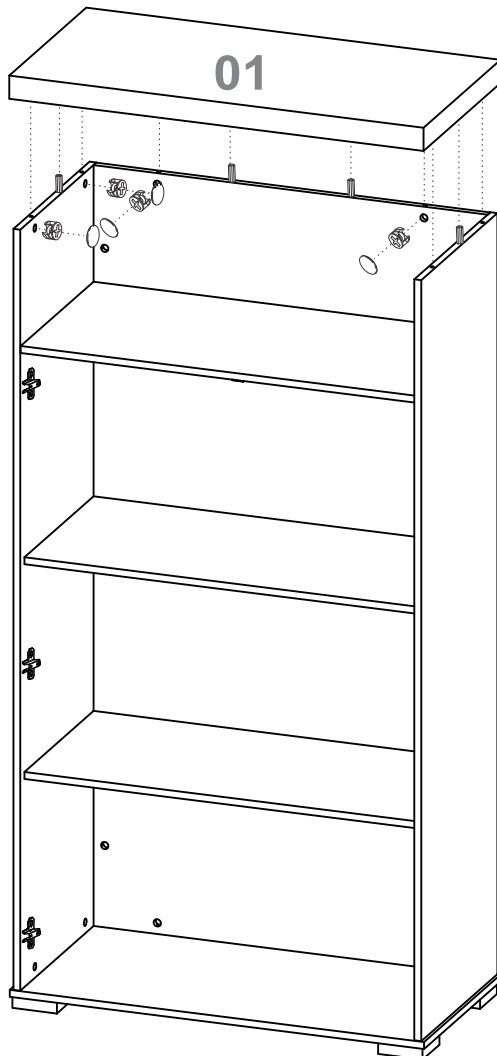

6X

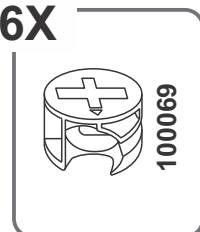

100069

6X

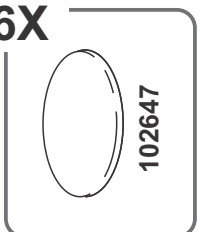

102647



11

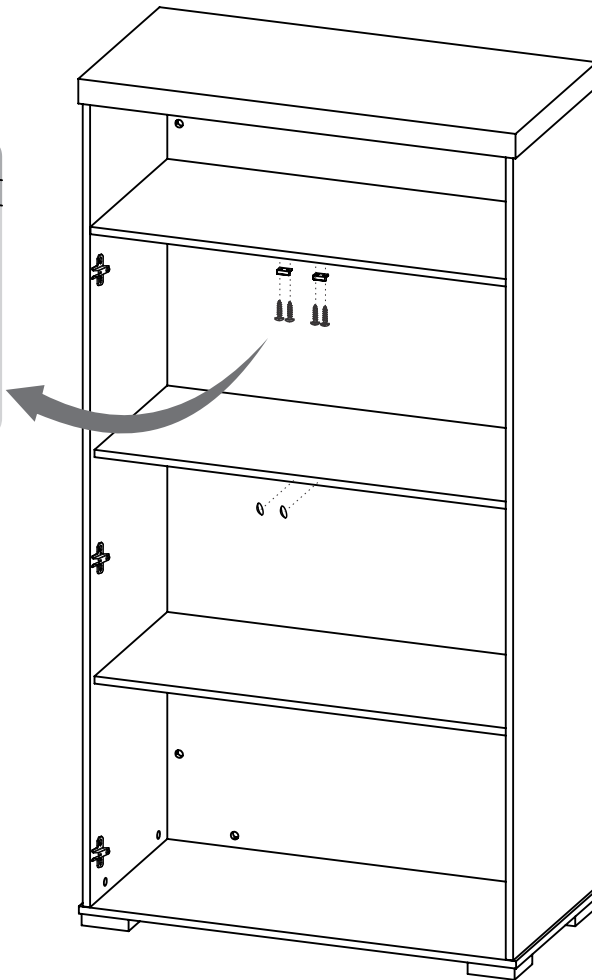
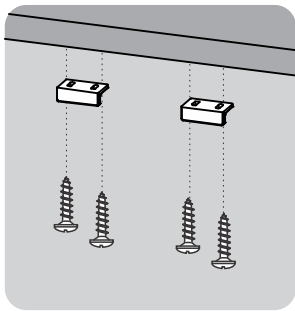

4X

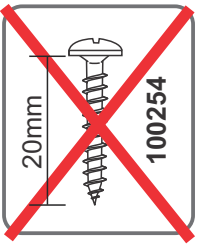
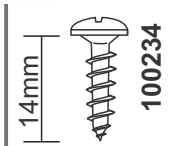

2X

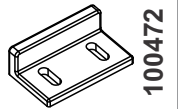

2X



12

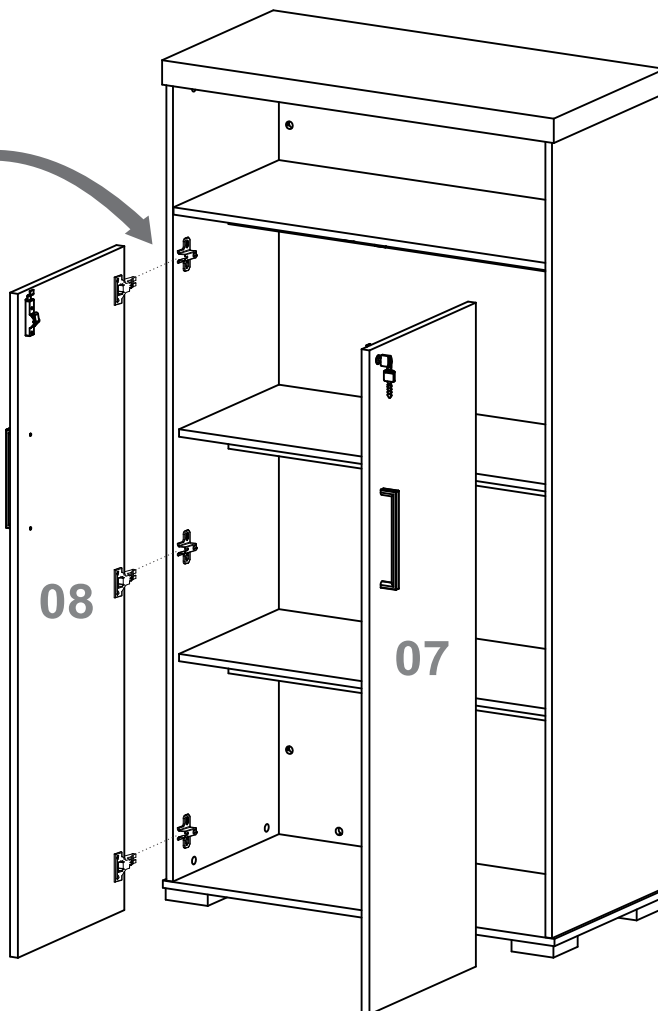
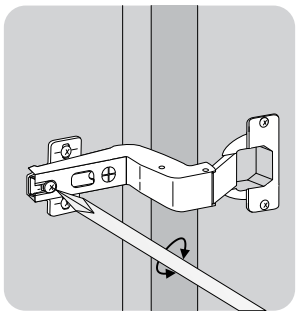

COMO AJUSTAR AS PORTAS  
CÓMO AJUSTAR LAS PUERTAS  
HOW TO ADJUST THE DOORS

