

Arquivo Tamburato 4 Gavetas II Linha Executiva

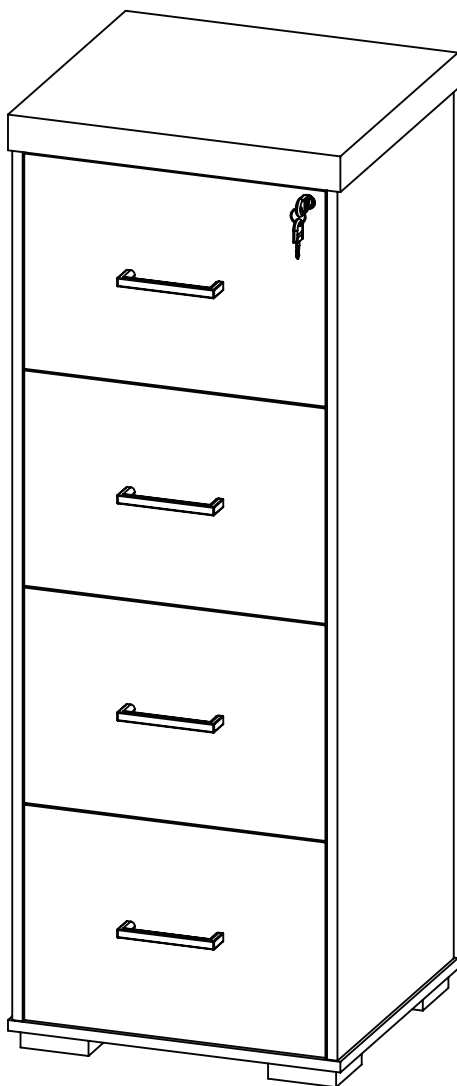

ARTANY[®]
Arte em Escritórios

Conheça outros produtos da nossa empresa no site: www.artany.com.br
Conozca otros productos en el sitio: www.artany.com.br
Know another products in: www.artany.com.br

- Siga atentamente todas as instruções de montagem;
- Monte seu produto no local ou próximo de onde será colocado. Movimentações do produto já montada, podem avariá-lo;
- Faça a montagem em uma superfície limpa e plana. Aconselhamos usar a própria embalagem de papelão para forrar o chão;
- Verifique se as quantidades de peças e acessórios estão de acordo com o manual de montagem;
- Compare atentamente os furos de cada peça com a ilustração do manual;
- Utilize as ferramentas indicadas. Só utilize parafusadeira se tiver conhecimento e habilidade. O uso inapropriado pode danificar peças e/ou acessórios;
- Se o produto necessitar fixação na parede, tenha cuidado para não atingir fios e canos ao furar a parede.

Obs: Caso necessite solicitar peças de reposição, por favor, utilize os códigos dos mesmos.

- Siga con atención todas las instrucciones de armado.
- Arme su mueble en un lugar cerca donde será instalado. Mover el producto ya montado puede perjudicarlo.
- Haga el montaje en una superficie limpia y plana. Aconsejamos usar el propio embalaje de cartón para forrar el suelo.
- Asegúrese de que las cantidades de piezas y accesorios coincidan con el manual de montaje.
- Compare cuidadosamente los agujeros de cada pieza con la ilustración del manual.
- Utilice las herramientas indicadas. Sólo utilice atornillador automático si tiene conocimiento y habilidad. El uso inapropiado puede dañar piezas y/o accesorios.
- Si el producto necesita fijación en la pared, tenga cuidado de no alcanzar cables y cañones al perforar la pared.

OBS: Si necesita solicitar piezas y / o accesorios de repuesto, por favor, utilice los códigos de los mismos.

- Follow carefully the assembly instructions.
- Assemble your furniture in a place near where it will be installed. Moving the assembled product can harm it.
- Make the assembly on a clean and flat surface. We recommend using the cardboard box to cover the floor.
- Make sure the quantities of parts and accessories match the assembly manual.
- Carefully compare the holes in each piece with the illustration in the manual.
- Use the indicated tools. Only use an automatic screwdriver if you have knowledge and skill. Improper use can damage parts and/or accessories.
- If the product needs fixing on the wall, be careful and don't reach cables and cannons when drilling the wall.

NOTE: If you need to request spare parts and/or accessories, please use the codes according of this instruction manual.

CONSERVAÇÃO E LIMPEZA

MANTENIMIENTO Y LIMPIEZA / MAINTENANCE AND CLEANING

Não expor o produto ao sol, altas temperaturas e umidade, mantendo-o em local seco e arejado. Para a limpeza, utilizar um pano seco e macio. Não é necessário o uso de materiais abrasivos ou álcool.

No exponga el producto al sol, altas temperaturas y la humedad. Mantener en local seco y ventilado. Para limpiar, utilice un paño suave y seco. No es necesario el uso de materiales abrasivos o alcohol.

Do not expose the product to sunlight, high temperatures and humidity. Keep it in a dry and ventilated place. To clean it, use a soft and dry cloth. It is not necessary to use abrasive materials or alcohol.

Garantia

Este certificado de Garantia é uma vantagem adicional oferecida ao consumidor, porém para que o mesmo tenha validade é imprescindível que seja apresentada a NOTA FISCAL de compra do produto e o número do lote (ver etiqueta).

Com este produto, a **Artany** tem como objetivo atender plenamente o proprietário-consumidor, proporcionando a garantia na forma aqui estabelecida, pelo período de 03 meses a partir da data da nota fiscal de compra. A **Artany** restringe a sua responsabilidade à substituição gratuita das peças defeituosas, em caso de defeitos ou avarias devidamente constatados como sendo de fabricação, durante a vigência desta garantia.

A **Artany** declara a garantia nula e sem efeito se o produto for alterado, adulterado, molhado ou consertado e ainda pela prática de montagem inadequada. Também será considerada nula em casos de força maior, como aqueles causados por agentes da Natureza (chuvas, incêndios, excesso de umidade...).

Para exercer seus direitos de comprador é importante que antes de montar seu produto você leia com atenção as instruções de cada passo do manual de montagem que acompanha o móvel.

Caso o produto não esteja em conformidade, entre em contato com a loja onde efetuou a compra ou com o nosso Serviço de Atendimento ao Cliente através do fone (41) 3556 1500 ou do e-mail assistencia@artany.com.br, e faça sua reclamação, apontando os defeitos técnicos observados, que teremos o maior prazer em atendê-lo. Para agilizar o seu atendimento, tenha sempre em mãos o manual de montagem com os respectivos números das peças defeituosas conforme descritas no manual.

A **Instalação Trilho Telescópico - 350mm (102236)**
Preparación del Guia Telescópico / Installation of the telescopic sliders

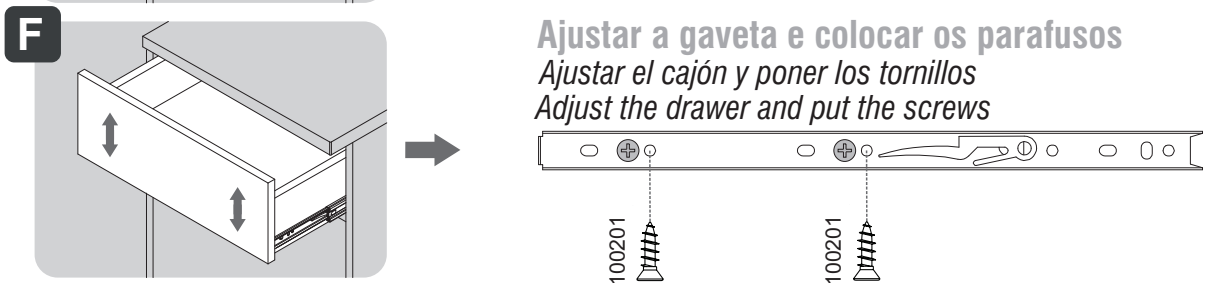
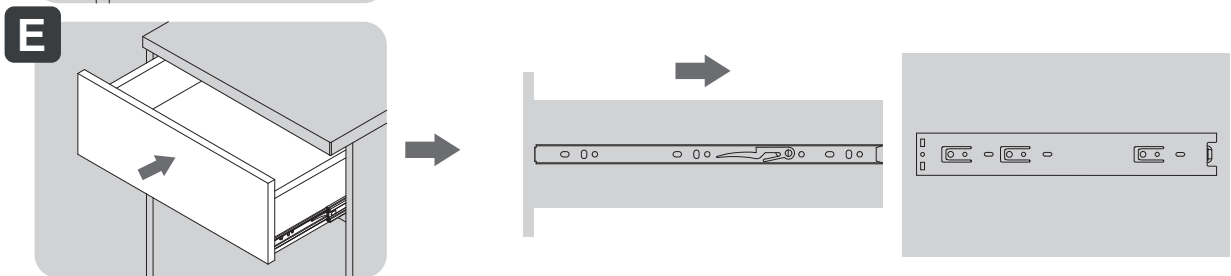
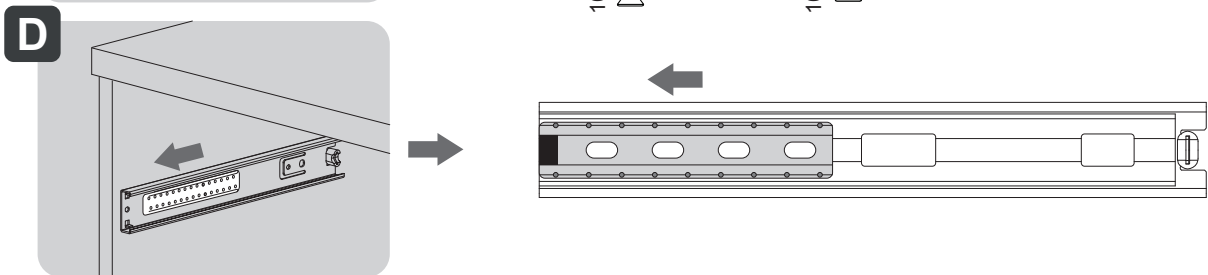
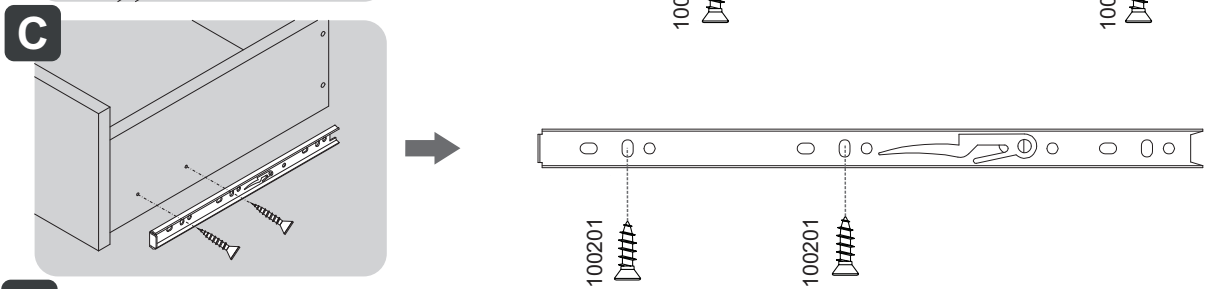
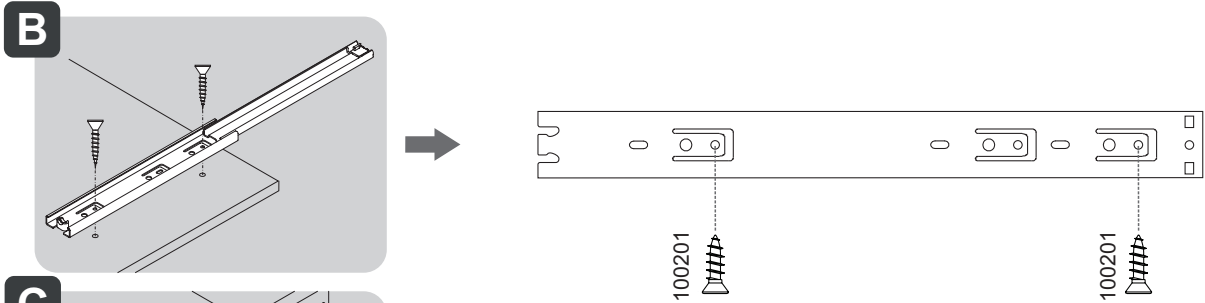
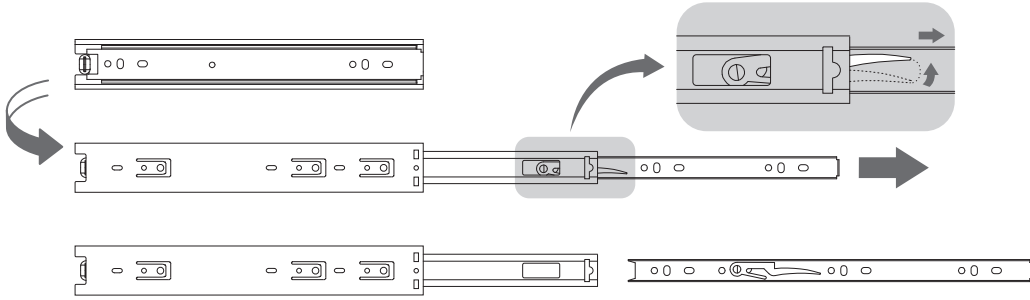

Como retirar a gaveta *Cómo sacar el cajón* / **How to take off the drawer**

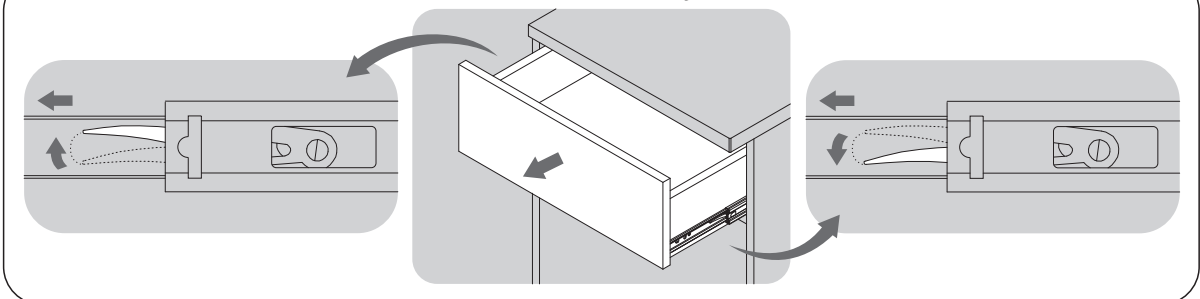

FERRAMENTAS **NÃO** FORNECIDAS, MAS NECESSÁRIAS
PARA A MONTAGEM DO PRODUTO

HERRAMIENTAS **NO** SUMINISTRADAS, MAS NECESARIAS PARA EL MONTAJE DEL PRODUCTO
TOOLS **NOT** SUPPLIED, BUT NECESSARY FOR THE ASSEMBLY



100097

6X



100070

52X



100069

52X

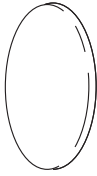

102555 - PRETO
NEGRO / BLACK

52X

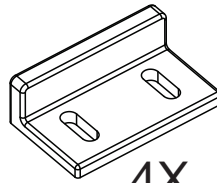

100472

4X

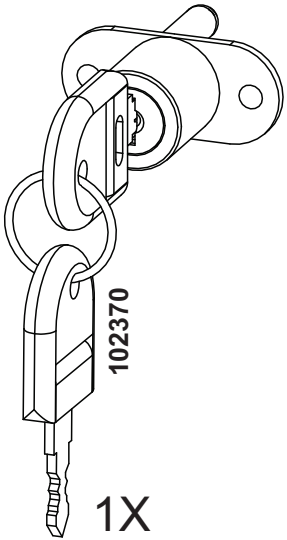

102370

1X

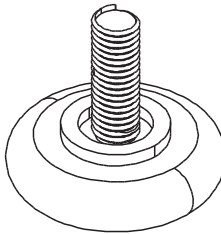

100526

4X

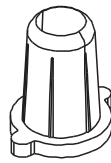

100560

4X



100201

40X



102349

14X



102807

8X

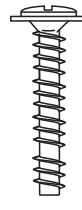

100892 - B

8X

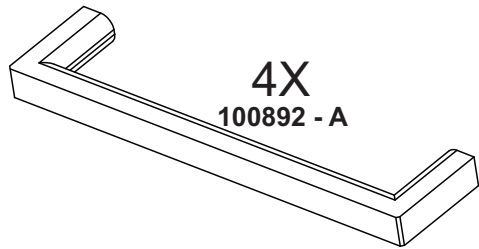

4X
100892 - A

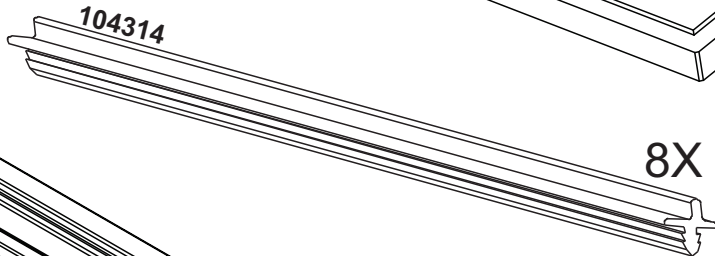

104314

8X

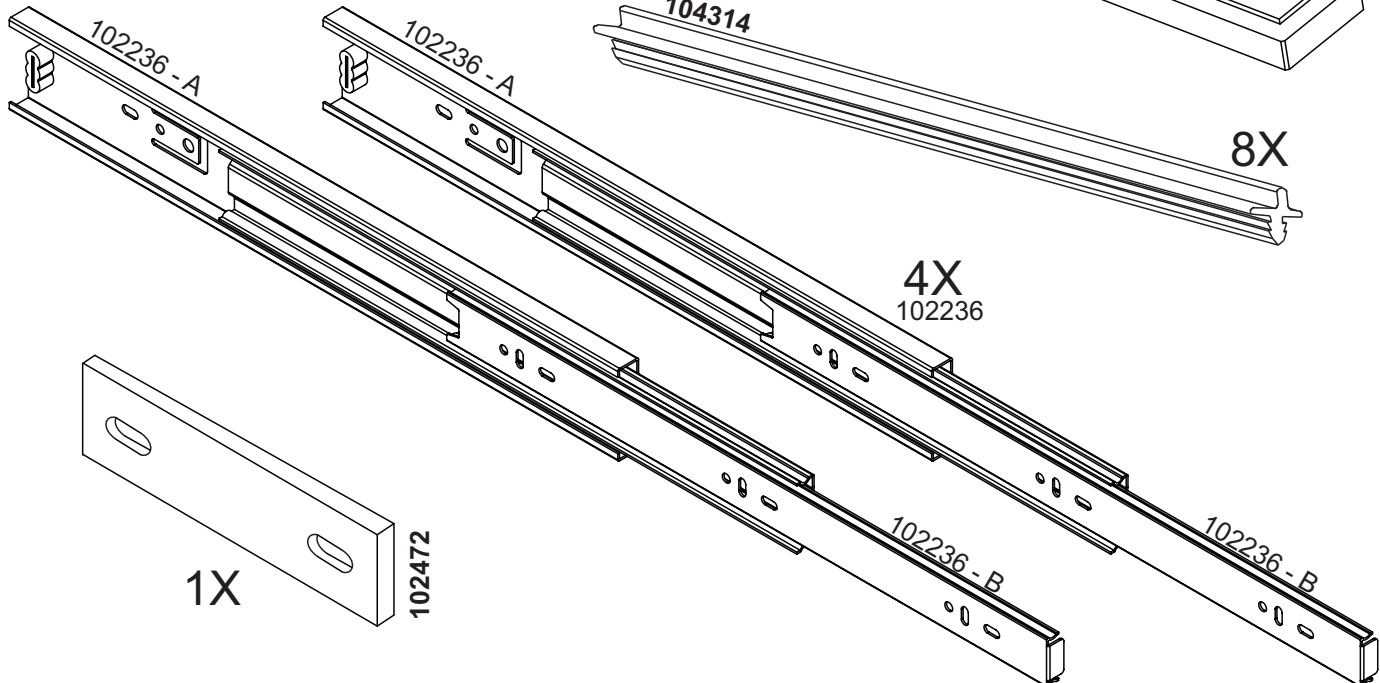

102236 - A

102236 - A

4X
102236

102236 - B

102236 - B

1X

102472

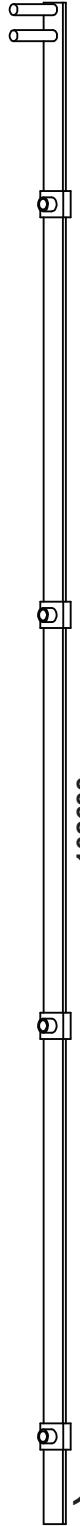

102633

1X

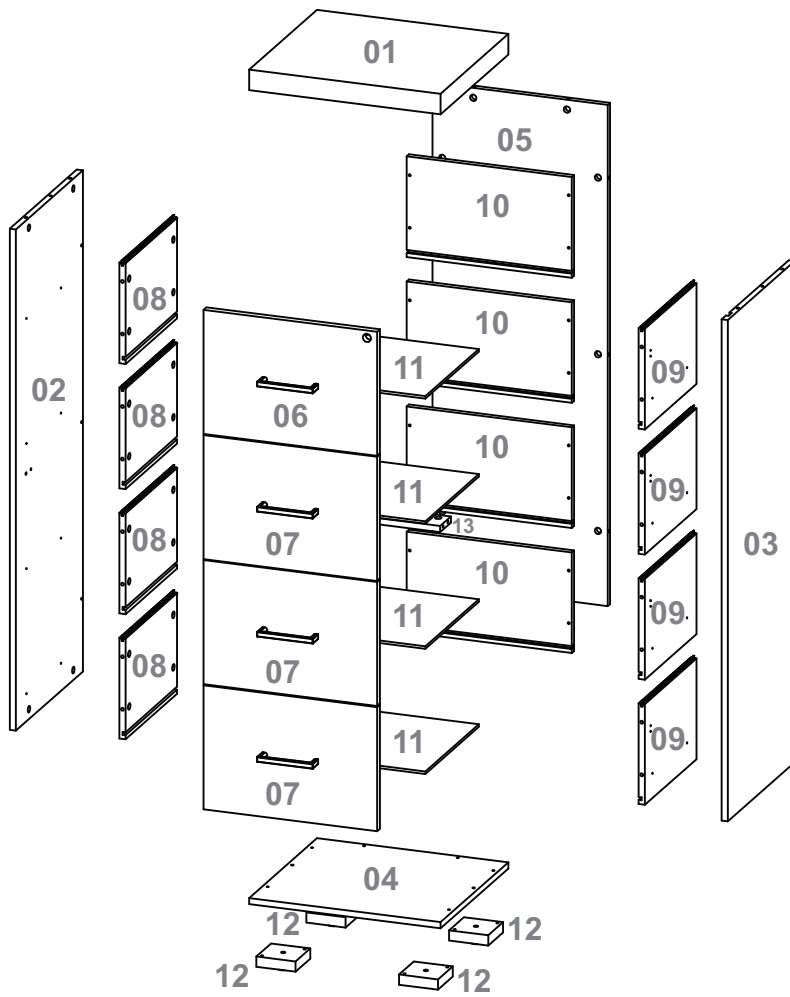

Número Número	Medida Dimensión Size	Quantidade Cantidad Quantity
01	470x440x50mm	01
02	1220x435x15mm	01
03	1220x435x15mm	01
04	470x440x15mm	01
05	1220x430x15mm	01
06	426x302x18mm	01
07	426x302x18mm	03
08	335x245x15mm	04
09	335x245x15mm	04
10	405x245x15mm	04
11	387x347x6mm	04
12	96x96x25mm	04
13	430x70x15mm	01

1

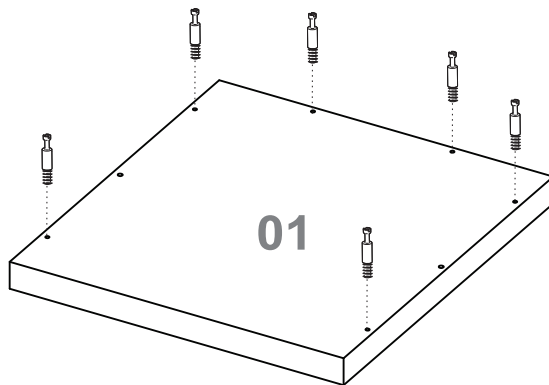

6X

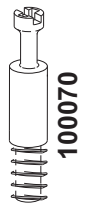

2

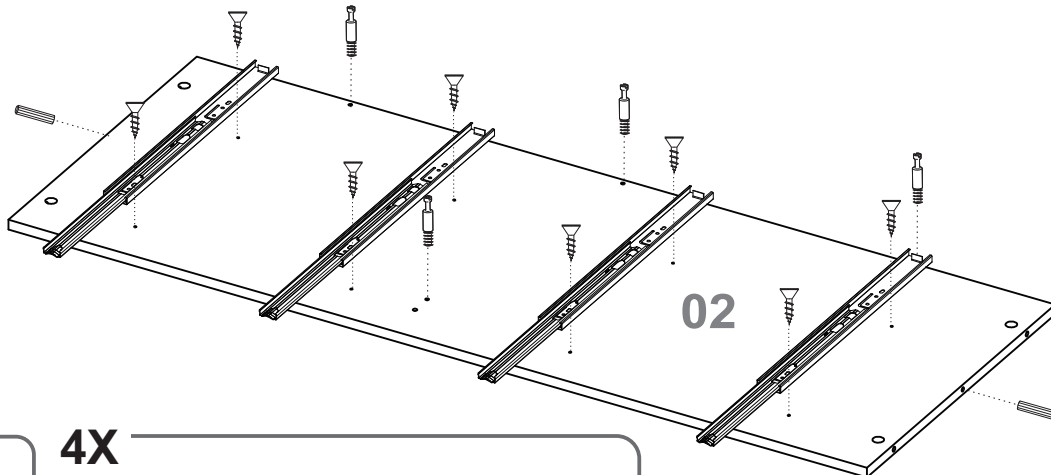

2X



4X

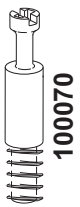

4X

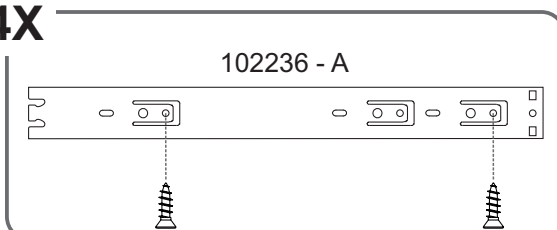

8X



3

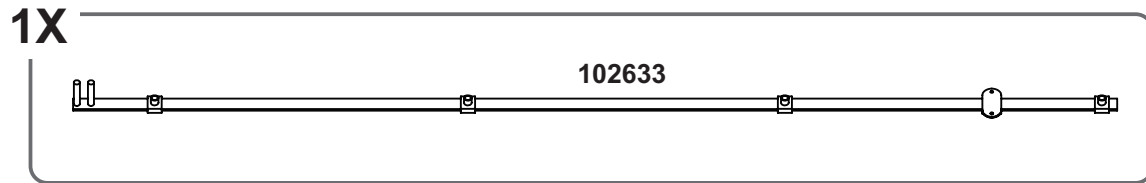
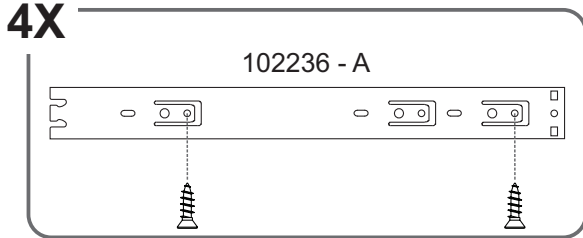
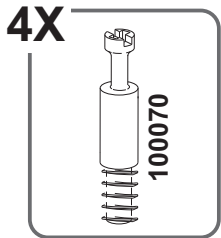
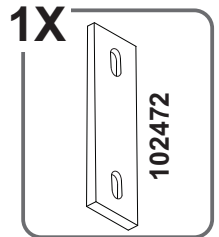
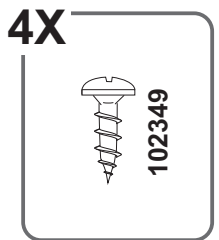
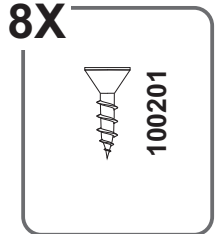
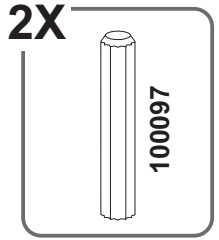
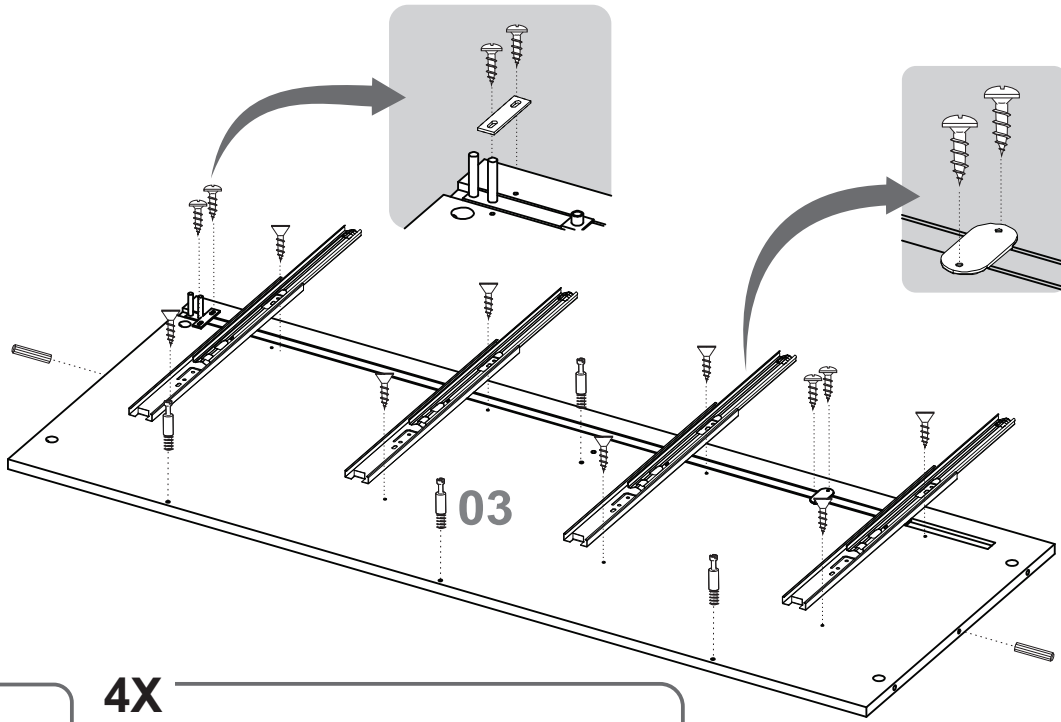

4

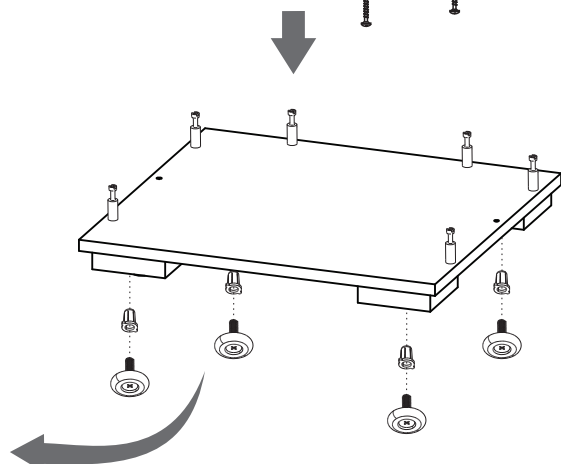
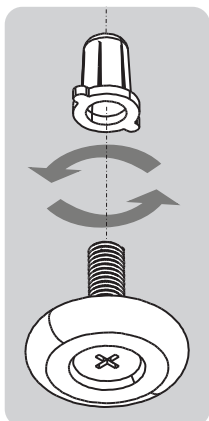
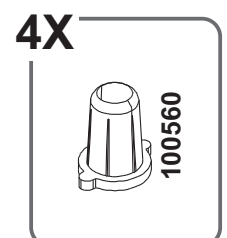
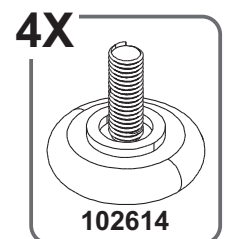
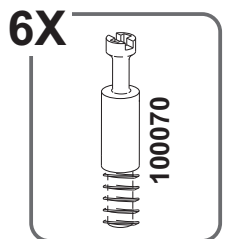
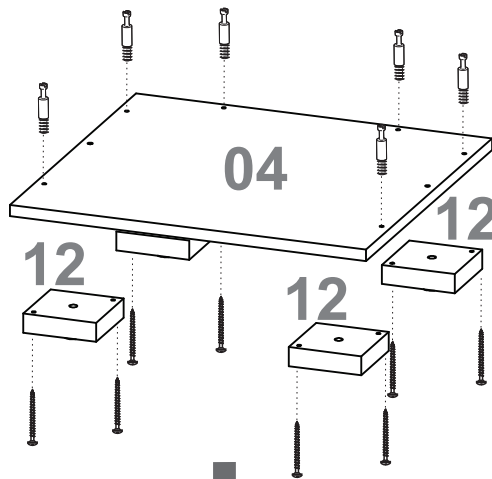
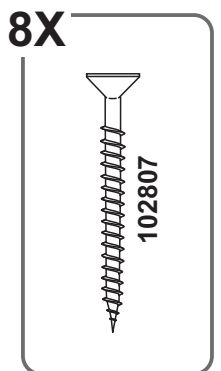

5

4X

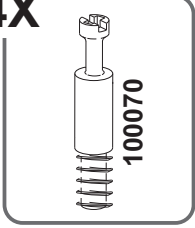

1X

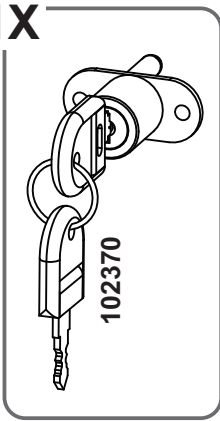

2X

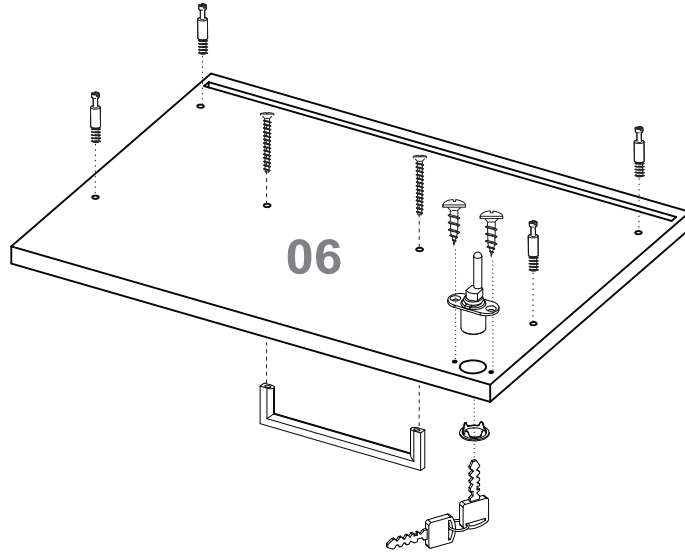

1X

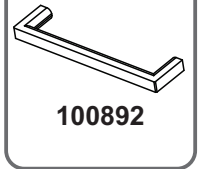

2X

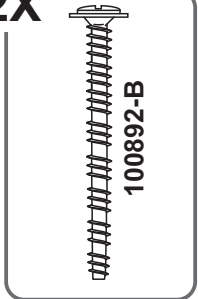

6

12X

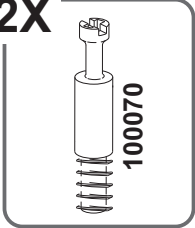

3X →

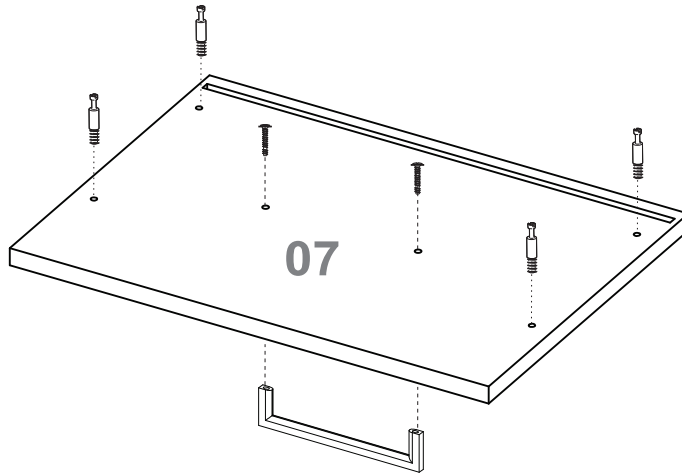

3X

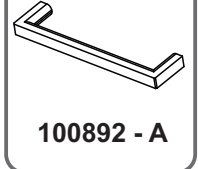

6X

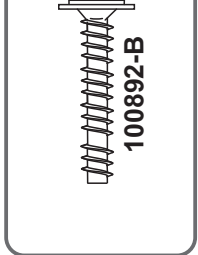

7

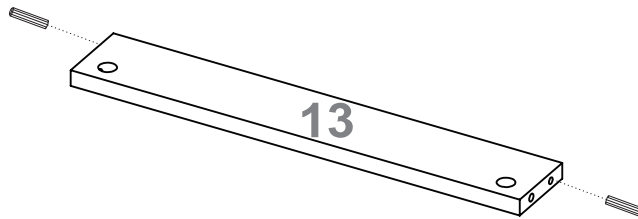

2X

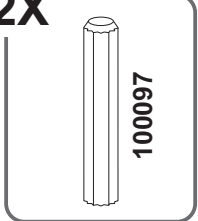

8

4X →

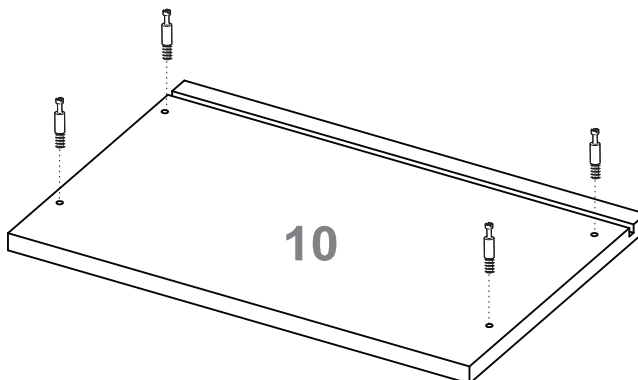

16X

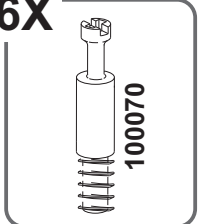

9

32X

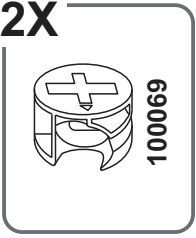

32X

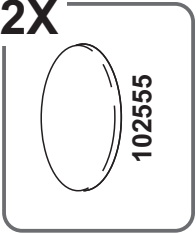

4X →

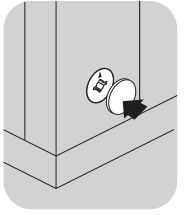
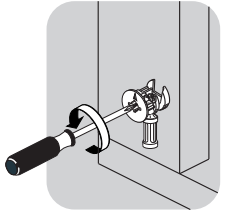
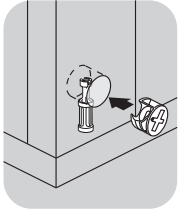
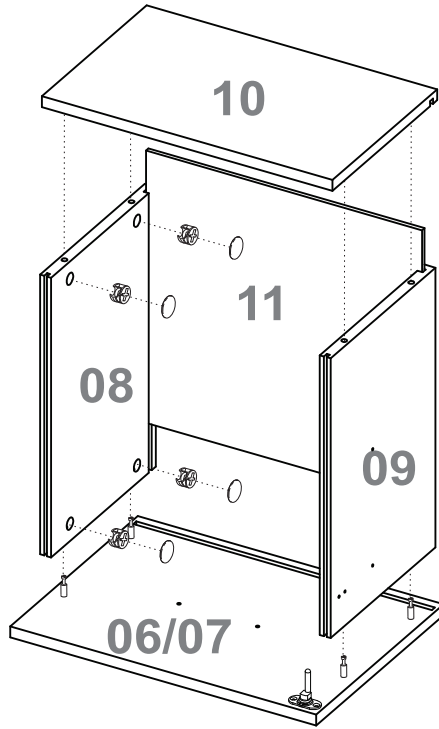

10

8X

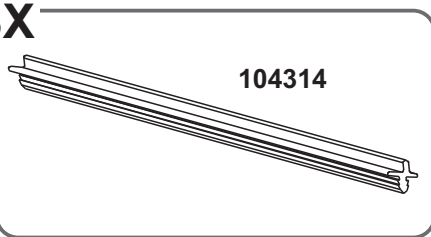

8X

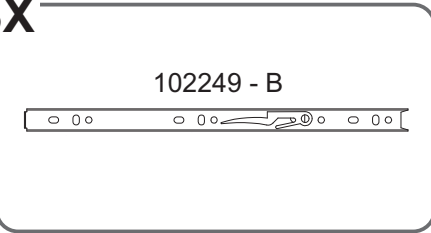

4X →

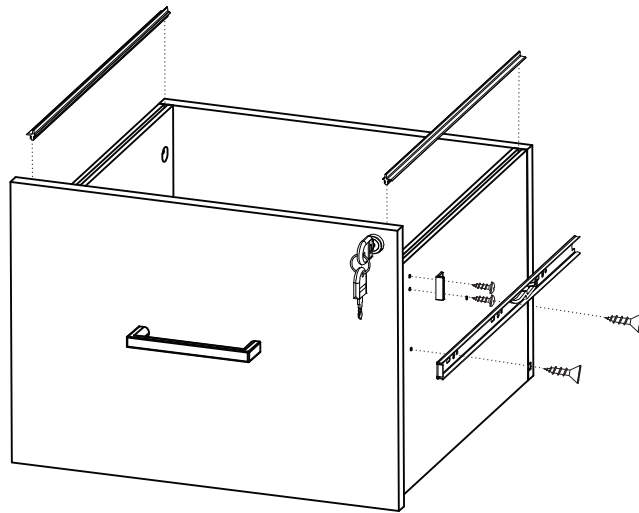

16X

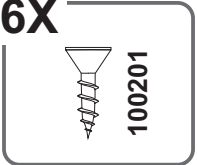

8X

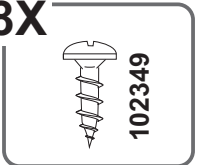

4X

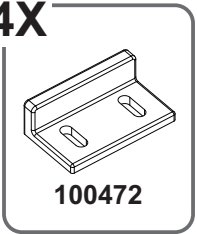

11

8X

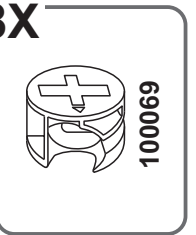

8X

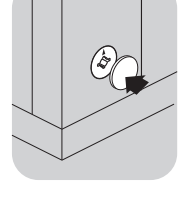
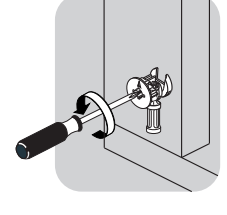
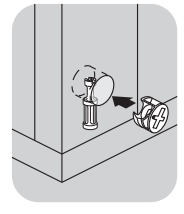
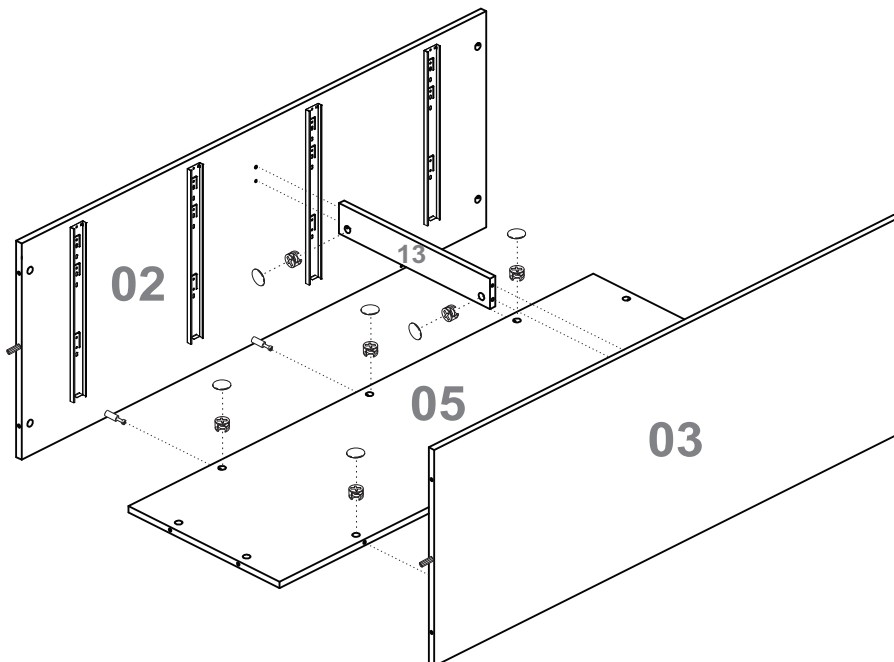
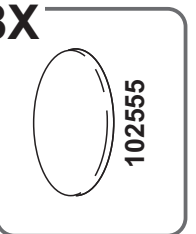

12

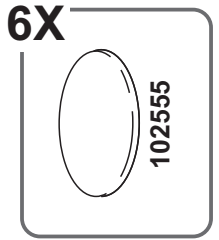
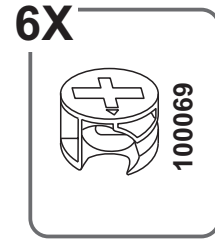
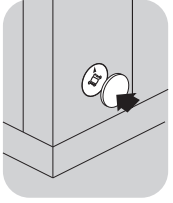
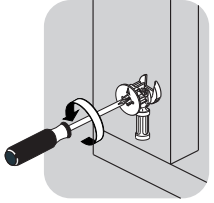
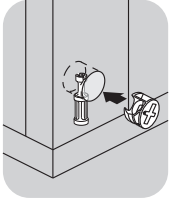
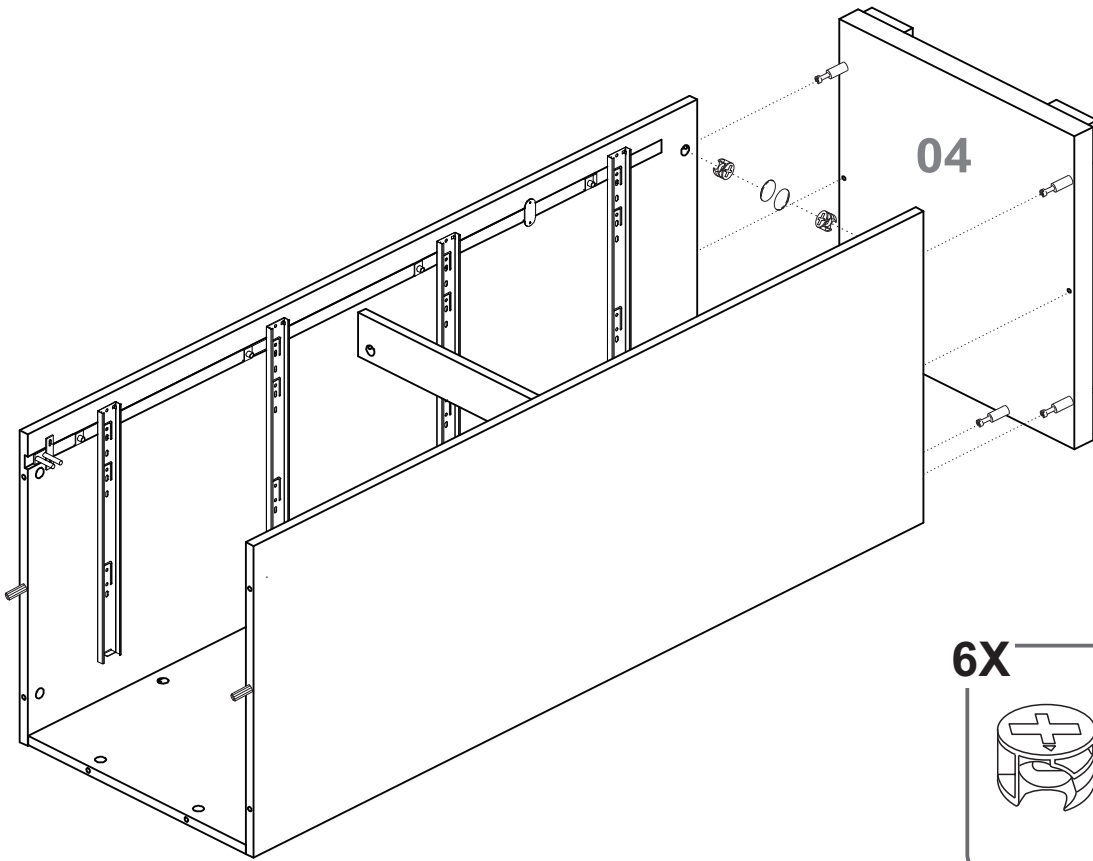

13

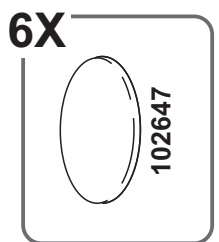
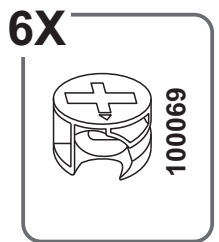
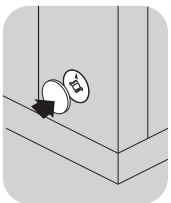
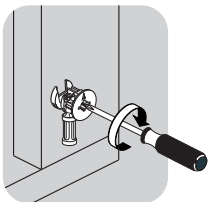
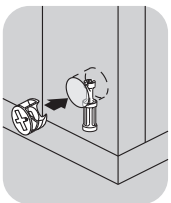
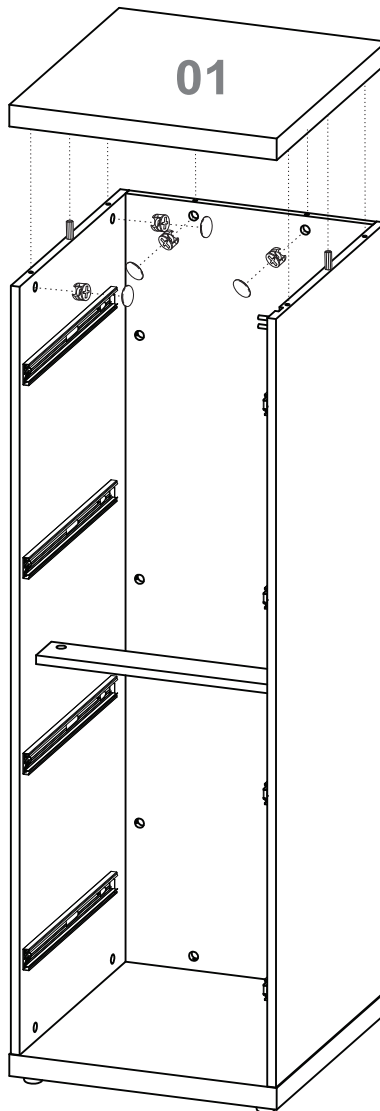

ATENÇÃO

ATENCIÓN / ATTENTION

Depois de colocar a gaveta ajustar o trilho conforme o **Passo F** da Instalação do Trilho Telescópico.

Después de colocar el cajón, ajustar el guía de acuerdo a el **Paso F** de la Preparación del Guía Telescópico.

After attaching the drawer, adjust the rail according to **Step F** of the Telescopic Sliders Installation.

8X

100201

