

BN-3642



Instruções de Montagem Assembly Instructions Instrucciones de Armado

Acesse Vídeos de Montagens
Access Mounting Videos
Acceder a los Vídeos de Montaje
www.tecnomobili.ind.br

tecnomobili

Estrada RSC 453, Km s/n° | Garibaldi | RS
CEP: 95720-000 | Fone / Fax: 54.3464.2050
sac@moveisvideira.com.br

Notas Especiais:

01 -Examine completamente todas as peças do móvel antes de começar o trabalho.

02 -Recomenda-se montar o móvel conforme este Manual de Montagem.

03 -É de responsabilidade do montador seguir as instruções do Manual de Montagem, que são fundamentais para garantir a estrutura do móvel.

04 -Para limpeza, utilizar somente pano úmido e sabão neutro.

Special notes:

01 -Check all parts of the unit thoroughly before starting work.

02 -It is recommended to assemble the furniture according to this Installation Manual.

03 -It is the responsibility of the assembler to follow the instructions in the Assembly Manual, which are essential to ensure the structure of the furniture.

04 -For cleaning use only damp cloth and neutral soap.

Notas especiales:

01 -Examine completamente todas las piezas del mueble antes de iniciar el trabajo.

02 -Se recomienda montar el mueble conforme el Manual de Ensamblaje.

03 -Es de responsabilidad del montador seguir las instrucciones del Manual de Ensamblaje, que son fundamentales para garantizar la estructura del mueble.

04 -Para limpieza solamente usar trapo húmedo y jabón neutro.

Guarante certificate:

The guarantee of products manufactured by Móveis Videira LTDA covers any defects / manufacturing defects, within the period established by the Consumer Protection Code, in its Article 26, II, which provides for a legal guarantee of ninety (90) days.



Cód	DESCRIÇÃO	DESCRIPTION	DESCRIPCIÓN	QTD	RAW MATERIAL	DIMENSION	CÓD
01	Painel Espelho	Mirror Panel	Panel Espejo	1	MDP 15mm	450x450x15mm	903642
02	Prateleira Superior	Top Shelf	Estante Superior	1	MDP 15mm	450x126x15mm	203642
03	Suporte Painel	Panel Support	Soporte Panel	4	MDP 15mm	300x50x15mm	7108

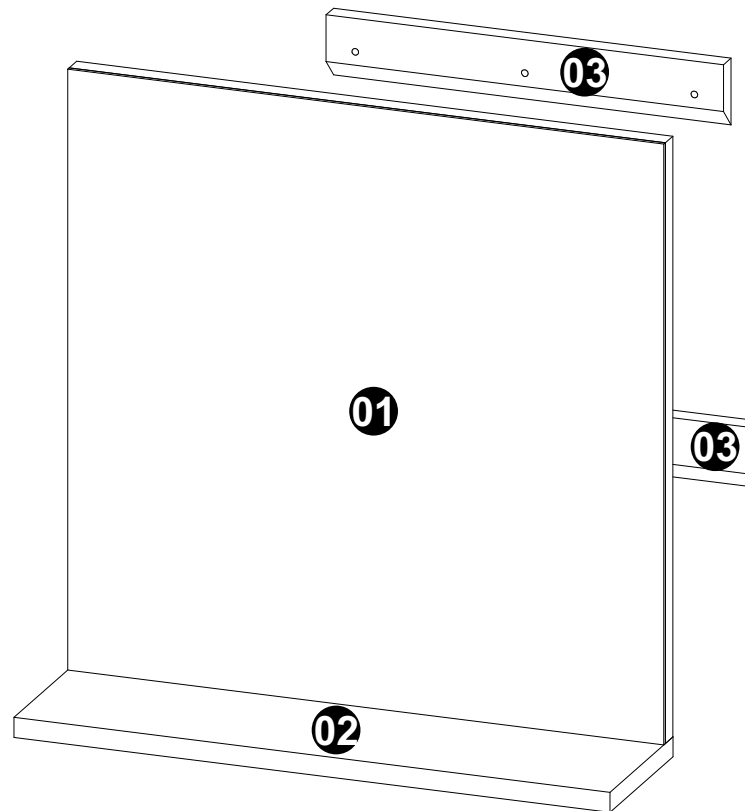

TAMANHO REAL - TAMAÑO VERDADERO - REAL SIZE

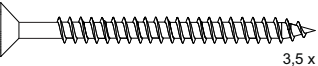
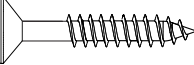
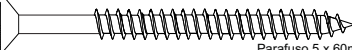
REF	DESCRIÇÃO	QTD	CÓD
A	 Cavilha 5 x 30mm	02	3880
B	 3,5 x 40mm CC	03	8115
C	 Parafuso 4 x 25mm CC	04	9511
D	 Parafuso 5 x 60mm CC	04	1618

LUSTRAÇÃO - ILUSTRACION - ILLUSTRATION

REF	DESCRIÇÃO	QTD	CÓD
E	 40x8mm Bucha 8mm	04	5623

Ferramentas | Tools | Herramientas

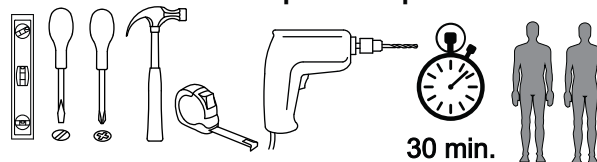

Use the ruler below to measure the components

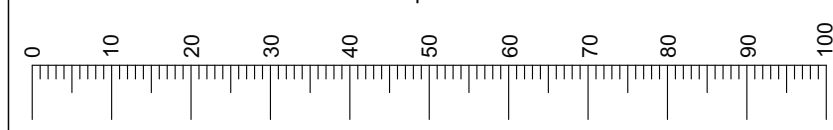

Revisão: 00
Data: 13/06/2023

