



JCM
movelaria

Livreiro Emoção Emoção Bookshelf Estantería Emoção



Indicamos que a montagem dos produtos seja realizada com parafusadeira eléctrica e por um montador profissional.
We recommend that a professional furniture assembler assemble the product by using a cordless screwdriver.
Se recomienda que un montador de muebles profesional realice el montaje del producto con un destornillador eléctrico.

AVISO: Não nos comprometemos pelo mal-uso, montagem e fixação do produto à parede. Portanto, não somos responsáveis por danos e quedas do produto, eletrónicos e pertences neles contidos. É importante o uso de brocas e ferramentas compatíveis na montagem.
NOTICE: The company is not responsible for the misuse, assembly, and wall fixation, as well as the damages and falls that the products, electronics, and belongings therein might suffer. It is important to use suitable drills and tools to assemble the product.
ATENCIÓN: La empresa no se responsabiliza del mal uso, montaje y fijación del producto a la pared, así como de daños y caídas del producto, electrónicos u objetos. Es importante el uso de taladros y herramientas compatibles con el montaje.

Dica: para evitar possíveis avarias, use a embalagem do produto como apoio durante a montagem.
Tip: to avoid damages, use the product packaging as a base during the assembly.
Pista: para evitar daños, use el envase del producto como apoyo durante el montaje.

RELAÇÃO DE FERRAGENS | HARDWARE LIST | LISTADO DE HERRAJES

BUCHA GESSO 10mm (A)	10mm DRYWALL ANCHOR (A)	TACO PARA YESO 10mm (A)	 01
CANTONEIRA 04 FUROS (B)	4-HOLE ANGLE BRACKET (B)	REFUERZO DE ÁNGULO 4 AGUJEROS (B)	 02
CAVILHA 6x30 (C)	6x30 DOWEL (C)	CLAVIJA 6x30 (C)	 06
PARAFUSO 3,5x14 (D)	3.5x14 SCREW (D)	TORNILLO 3,5x14 (D)	 26
PARAFUSO 3,5x25 (E)	3.5x25 SCREW (E)	TORNILLO 3,5x25 (E)	 02
PARAFUSO 7x60 (F)	7x60 SCREW (F)	TORNILLO 7x60 (F)	 01
PARAFUSO 5x40 (G)	5x40 SCREW (G)	TORNILLO 5x40 (G)	 22
PARAFUSO 5x50 (H)	5x50 SCREW (H)	TORNILLO 5x50 (H)	 08
PARAFUSO MINIFIX (I)	MINIFIX BOLT (I)	PERNO MINIFIX (I)	 04
PREGO 8x8 C/C (J)	8x8 NAIL (J)	CLAVO 8x8 (J)	 20
PUXADOR (K)	HANDLE (K)	TIRADOR (K)	 01
SAPATA DESLIZANTE (L)	GLIDE (L)	PATÍN (L)	 04
SUPORTE CANTONEIRA (M)	SUPPORT BRACKET (M)	ÁNGULO DE SOPORTE (M)	 01
TAMBOR MINIFIX (N)	MINIFIX CAM (N)	CAJA MINIFIX (N)	 04

RELAÇÃO DE PEÇAS | PARTS LIST | LISTADO DE PARTES

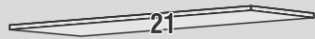
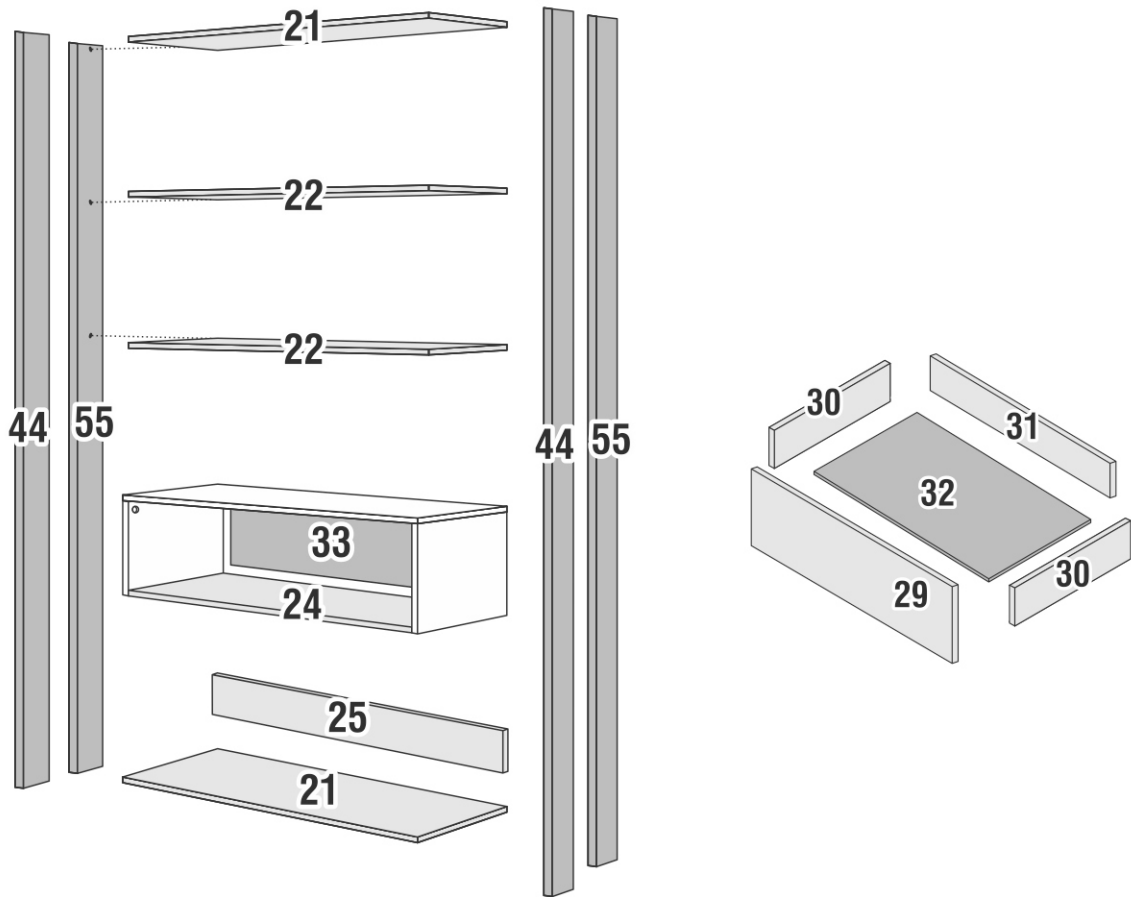

21 Tampo / Base
Top / Bottom
Tapa / Base 2Pcs

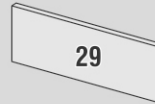

29 Frente Gaveta
Drawer Front
Frente del Cajón 1Pc



22 Prateleira Superior
Middle Shelf
Estantes Centrales 2Pcs



30 Lateral Gaveta
Drawer Side
Lateral del Cajón 2Pcs



23 Tampo Gaveteiro
Drawer Set Top
Tapa de la Cajonera 1Pc

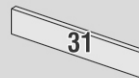

31 Traseiro Gaveta
Drawer Back
Trasera del Cajón 1Pc



24 Base Gaveteiro
Drawer Set Bottom
Base de la Cajonera 1Pc

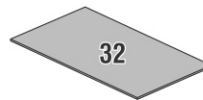

32 Fundo Gaveta
Drawer Bottom
Fondo del Cajón 1Pc



25 Travessa
Stretcher
Travesaño 1Pc

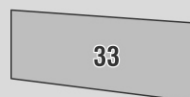

33 Costas
Back
Trasera 1Pc



27 Lateral Esquerda Gaveteiro
Drawer Set Left Side 1Pc
Lateral Izquierdo de la Cajonera



44 Lateral Frontal
Frontal Strip
Listón Frontal 2Pcs



28 Lateral Direita Gaveteiro
Drawer Set Right Side 1Pc
Lateral Derecho de la Cajonera



55 Lateral Traseira
Back Strip
Listón Trasero 2Pcs

Passo 01 COMECE A MONTAGEM PELA PEÇA 23. ENCAIXE AS PEÇAS 27 E 28 NA PEÇA 23 COM MINIFIX (I+N) PARAFUSE SUPORTE CANTONEIRA(M) COM PARAFUSO 3,5x14(D).

Step 01 START THE ASSEMBLY BY PART 23. FASTEN PARTS 27 AND 28 TO PART 23 WITH MINIFIX (I+N) SCREW USING THE ANGLE BRACKET (M) WITH 3,5x14 SCREW(D).

Paso 01 EMPIECE EL MONTAJE POR LA PARTE 23. FIJE LAS PARTES 27 Y 28 A LA PARTE 23 CON MINIFIX (I+N) ATORNILLE EL REFUERZO DE ÁNGULO (M) CON TORNILLO 3,5x14(D).

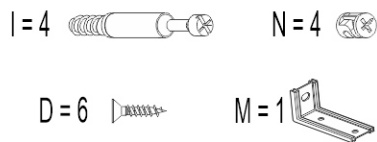
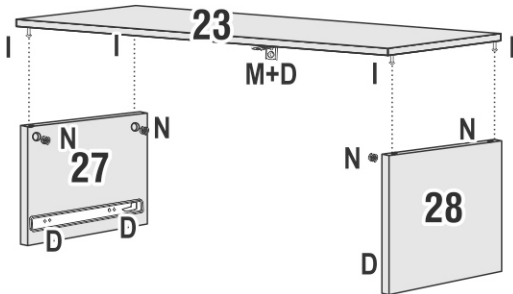

Passo 02 PARAFUSE A PEÇA 25 NAS PEÇAS 55 COM PARAFUSO 5x40 (G). PARAFUSE AS PEÇAS 21 E 22 NAS PEÇAS 44 E 35 COM PARAFUSO 5x40 (G). PARAFUSE A PEÇA 24 NAS PEÇAS 44, 55, 27 E 28 COM PARAFUSO 5x50 (H). PARAFUSE A PEÇA 23 NAS PEÇAS 44 E 55 COM PARAFUSO 5x50 (H).

Step 02 FASTEN PART 25 TO PARTS 55 WITH 5x40 SCREW (G). FASTEN PARTS 21 AND 22 TO PARTS 44 AND 55 WITH 5x40 SCREW (G). FASTEN PART 24 TO PARTS 44, 55, 27, AND 28 WITH 5x50 SCREW (H). FASTEN PART 23 TO PARTS 44 AND 55 WITH 5x50 SCREW (H).

Paso 02 FIJE LA PARTE 25 A LAS PARTES 55 CON TORNILLO 5x40 (G). FIJE LAS PARTES 21 Y 22 A LAS PARTES 44 Y 55 CON TORNILLO 5x40 (G). FIJE LA PARTE 24 A LAS PARTES 44, 55, 27 Y 28 CON TORNILLO 5x50 (H). FIJE LA PARTE 23 A LAS PARTES 44 Y 55 CON TORNILLO 5x50 (H).

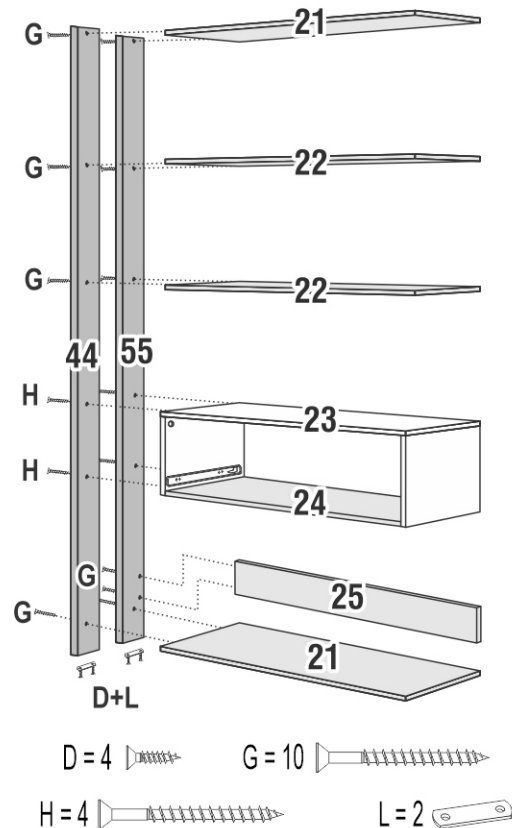

Passo 03 PARAFUSE A PEÇA 25 NAS PEÇAS 55 COM PARAFUSO 5x40 (G). PARAFUSE AS PEÇAS 21 E 22 NAS PEÇAS 44 E 55 COM PARAFUSO 5x40 (G). PARAFUSE A PEÇA 24 NAS PEÇAS 44, 55, 27 E 28 COM PARAFUSO 5x50 (H). PARAFUSE A PEÇA 23 NAS PEÇAS 44 E 55 COM PARAFUSO 5x50 (H).

Step 03 FASTEN PART 25 TO PARTS 55 WITH 5x40 SCREW (G). FASTEN PARTS 21 AND 22 TO PARTS 44 AND 55 WITH 5x40 SCREW (G). FASTEN PART 24 TO PARTS 44, 55, 27, AND 28 WITH 5x50 SCREW (H). FASTEN PART 23 TO PARTS 44 AND 55 WITH 5x50 SCREW (H).

Paso 03 FIJE LA PARTE 25 A LAS PARTES 55 CON TORNILLO 5x40 (G). FIJE LAS PARTES 21 Y 22 A LAS PARTES 44 Y 55 CON TORNILLO 5x40 (G). FIJE LA PARTE 24 A LAS PARTES 44, 55, 27 Y 28 CON TORNILLO 5x50 (H). FIJE LA PARTE 23 A LAS PARTES 44 Y 55 CON TORNILLO 5x50 (H).

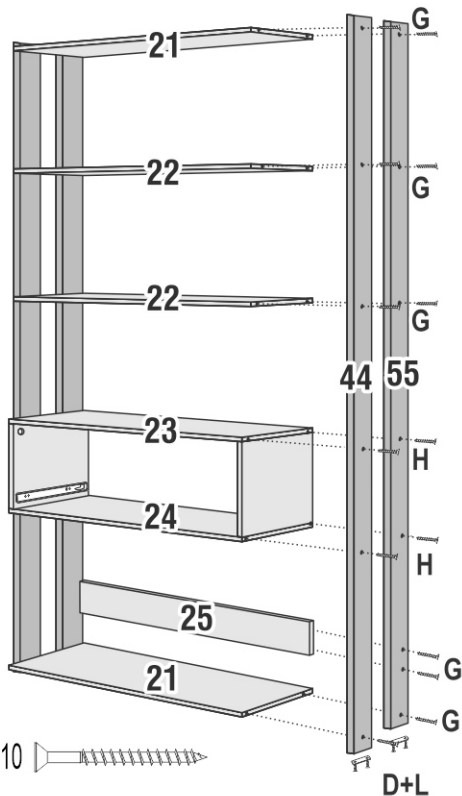

Passo 04 PREGUE A COSTA 33 COM PREGO 8x8 (J).

Step 04 FASTEN THE BACK WITH 8x8 NAILS (J).

Paso 04 FIJE LA TRASERA CON CLAVOS 8x8 (J).

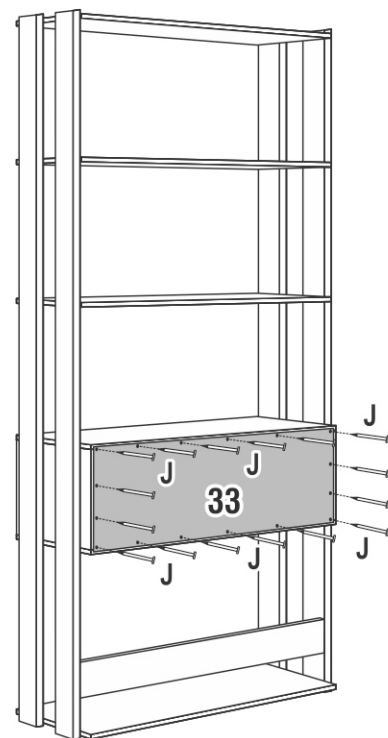

J = 16

VISTA TRASEIRA
BACK VIEW
VISTA TRASERA

Passo 05 PARAFUSE O LIVREIRO NA PAREDE USANDO SUORTE CANTONEIRA (M), PARAFUSO 7x60 (F) E BUCHA 10mm (A).
Step 05 SCREW THE BOOKSHELF INTO THE WALL BY USING THE ANGLE BRACKET (M), 7x60 SCREW (F), AND 10mm ANCHOR (A).
 Paso 05 ATORNILLE LA ESTANTERÍA A LA PARED USANDO EL REFUERZO DE ÁNGULO (M), TORNILLO 7x60 (F) Y TACO DE 10mm (A).

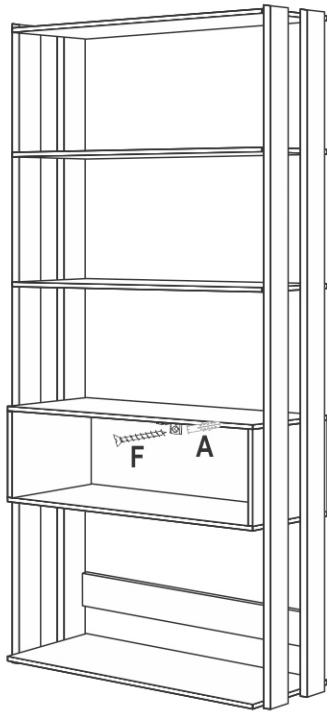

Passo 06 FAÇA A MONTAGEM DA GAVETA COM AS RESPECTIVAS FERRGENS.
Step 06 ASSEMBLE THE DRAWER WITH ITS RESPECTIVE HARDWARE.
 Paso 06 MONTE EL CAJÓN CON SUS RESPECTIVOS HERRAJES.

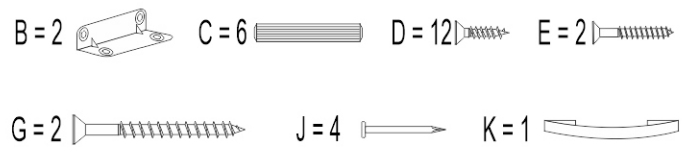
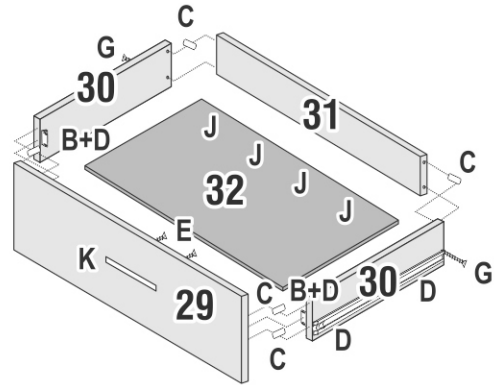

Passo 07 COLOCAR A GAVETA.
Step 07 INSERT THE DRAWER.
 Paso 07 PONGA EL CAJÓN.

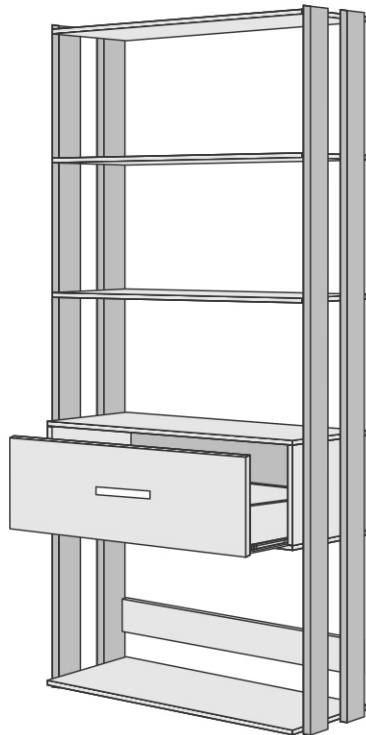

Passo 08 RACK MONTADO.
Step 08 PIECE ASSEMBLED.
 Paso 08 MUEBLE MONTADO.

