

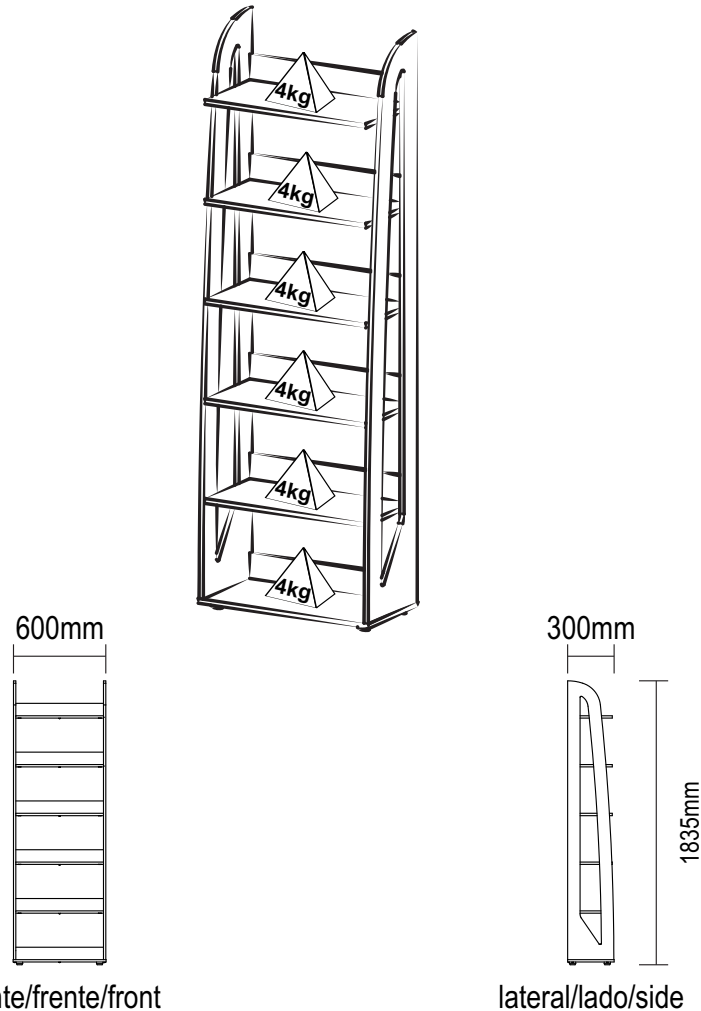

Estante Floripa

Estante Floripa / Floripa Bookcase

Versão 1.0 / Versión 1.0 / 1.0 Version



Conservação e Limpeza - Conservación y Limpieza - Conservation and Cleaning

Não expor o produto ao sol, altas temperaturas e umidade. Não arrastar objetos sobre a superfície do móvel (ex.: TV, DVD, aparelho de som, objetos decorativos...) e manter em local seco e arejado. Para a limpeza, utilizar um pano seco e macio. Não é necessário o uso de materiais abrasivos ou álcool.

No exponga el producto a la luz solar, las altas temperaturas y la humedad. No arrastre los objetos a través de la superficie de la unidad (por ejemplo, TV, DVD, equipo de música, objetos de decoración ...) Mantener en un lugar fresco y seco.

Para la limpieza, utilizar un paño seco y suave. El uso de materiales abrasivos o del alcohol no es necesario.

Do not expose the product to sunlight, high temperatures and humidity. Do not drag objects across the surface of the unit (TV, DVD, stereo, decorative objects ...) keep it in a cool dry place. For cleaning, use a dry and soft cloth. Do not use abrasive materials or alcohol.

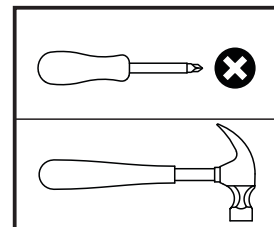
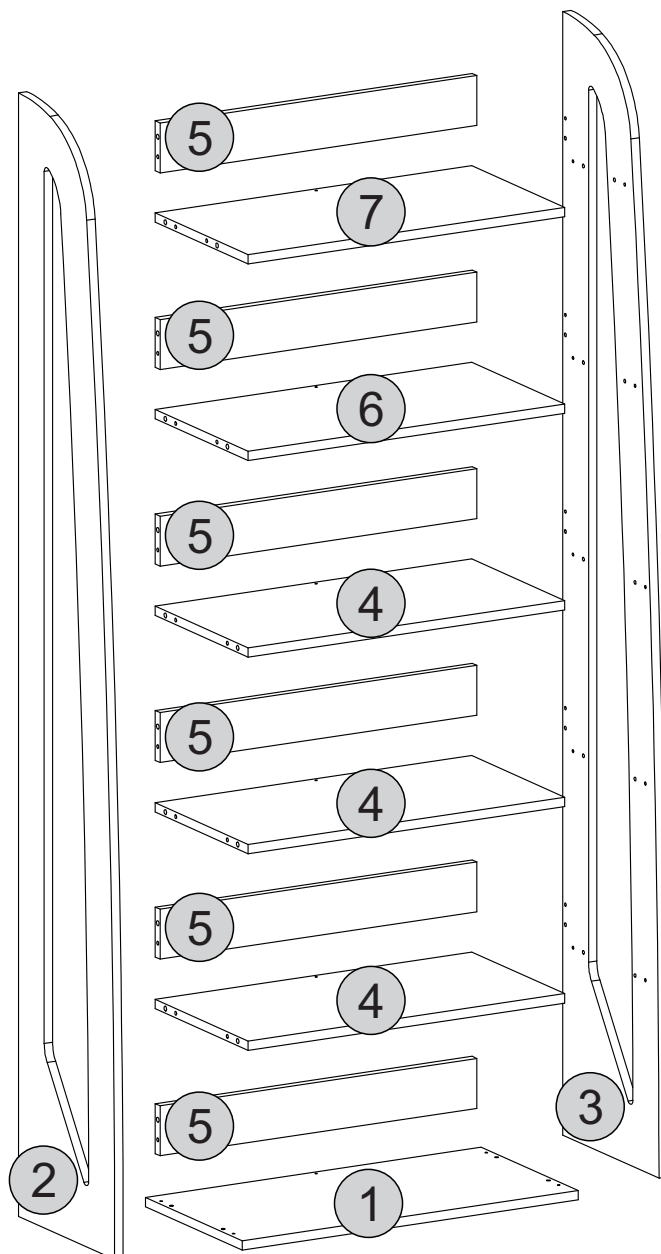





Descrição	Descripción	Description	Qtd
1-Base (600x300x15mm)	1-Base	1-Base	1
2-Lateral esquerda (1800x298x15mm)	2-Lateral izquierda	2-Left side	1
3-Lateral direita (1800x298x15mm)	3-Lateral derecha	3-Right side	1
4-Prateleira (566x288x15mm)	4- Anaquel	4-Shelf	3
5-Travessa (566x80x15mm)	5-Travesaño	5-Crosspiece	6
6-Prateleira int. (566x288x15mm)	6-Anaquele intermediario	6-Intermediary shelf	1
7-Prateleira sup. (566x288x15mm)	7-Anaquele superior	7-Upper shelf	1

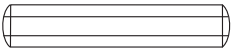
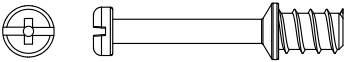
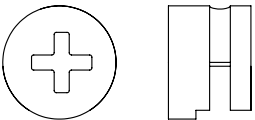

- O número na borda da peça corresponde ao manual.
- Para retirada do número usar Lustra-Móveis, Álcool em Gel ou Borracha.
- El número en el borde de la pieza coincide con el manual.
- Use una goma de borrar blanca, alcohol en gel o lustrador para muebles para eliminar los números.
- The number on the edge of the piece matches the manual.
- Use a White eraser, Alcohol Gel or Furniture Polish to remove the numbers.

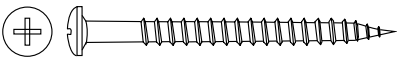
Lista de Materiais Lista de Materiales/ Hardware List

A		Cavilha / Tarugo / Dowel Ø6x30mm	36
B		Minifix / Minifix / Minifix Ø7x30mm	32
C		Tambor / Tambor / Minifix Cam Ø15x12mm	32
D		Tapa furo adesivo / Adhesivo / Hole Cover Ø18mm	32
E		Parafuso Tornillo / Screw Ø3,5x40mm CP	10
F		Sapata / Pata / Foot Ø40x26mm	04

DICAS PARA FIXAR MINIFIX

TIP TO FASTEN THE MINIFIX
PISTA PARA ARREGLAR EL MINIFIX

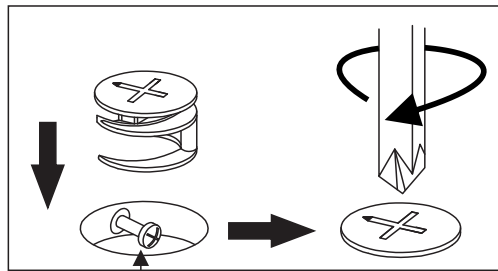

Cabeça do parafuso precisa estar no centro
La cabeza del tornillo debe estar en el centro
Screw head has to be in the center

Parafuso Minifix

Tornillo minifix/Minifix screw

Fixe o parafuso até o ressalto encostar na superfície da peça (veja o exemplo abaixo).

Tighten the screw until its overhang part lean on the piece surface (see the example below).

Fije el tornillo hasta que su parte sobressaliente toque la superficie de la pieza (vea el ejemplo abajo).

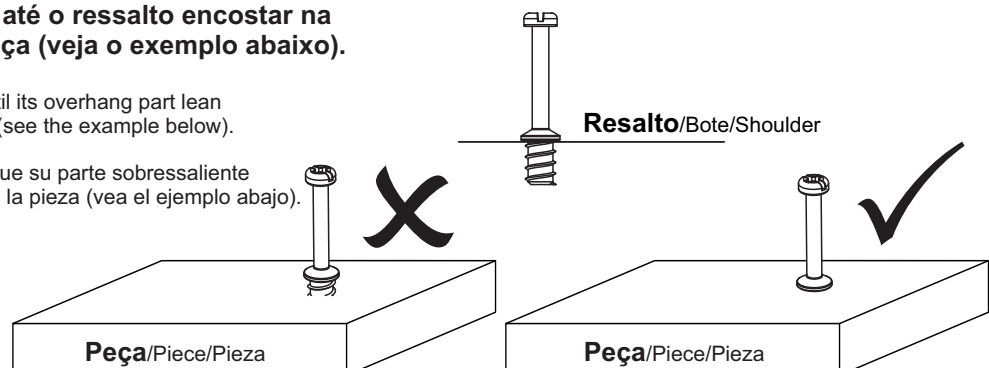

Passo 1

Paso/Step

PEÇA

Piece/Pieza

1 - BASE x1

FERRAGEM

Hardware/Herraje

F  04

FERRAMENTA

Tool/Herramienta

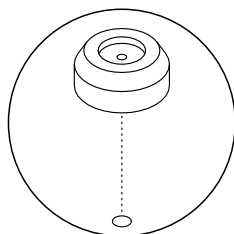
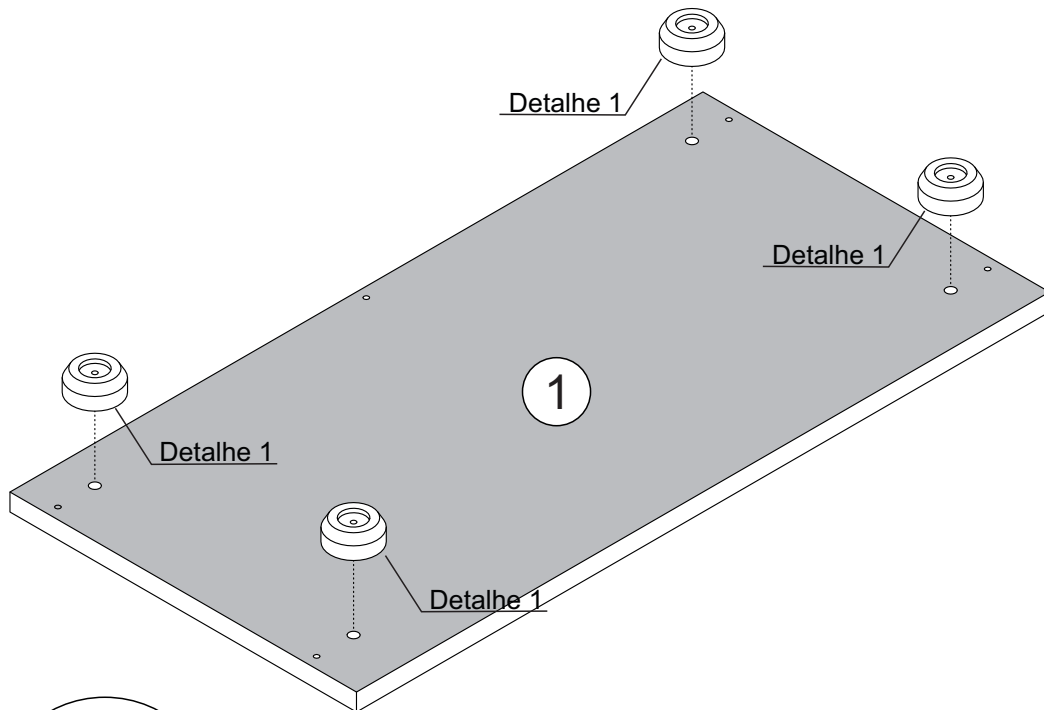
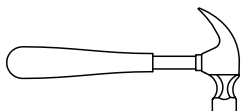

Detalhe 1
Detail/Detalle

Passo 2

Paso/Step

PEÇA

Piece/Pieza

4 - PRATELEIRA x3

5 - TRAVESSA x6

FERRAGEM

Hardware/Herraje

A  24

FERRAMENTA

Tool/Herramienta

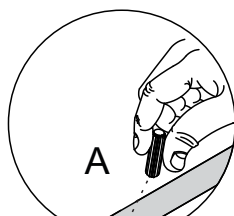
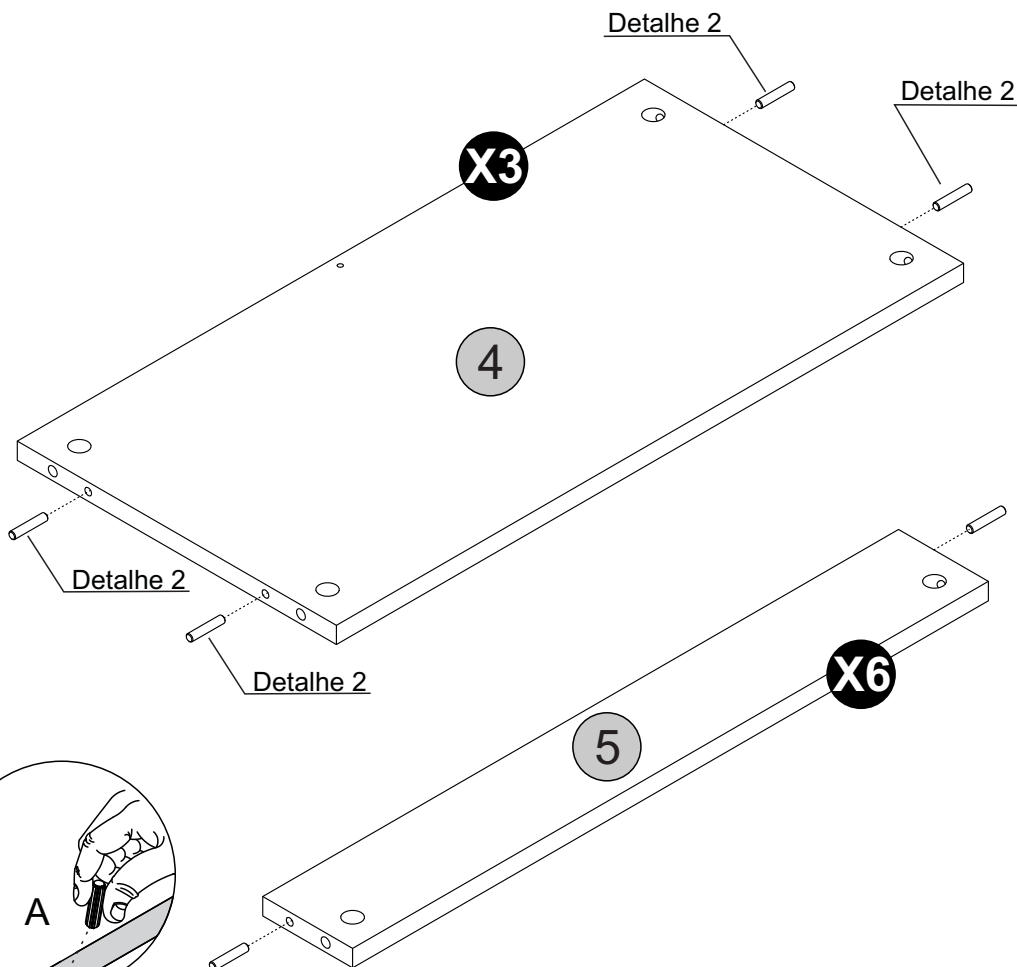
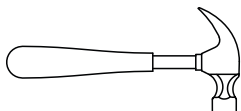

Detalhe 2
Detail/Detalle

Passo 3

Paso/Step

PEÇA

Piece/Pieza

6 - PRATELEIRA INT. x1

FERRAGEM

Hardware/Herraje

A  04

FERRAMENTA

Tool/Herramienta

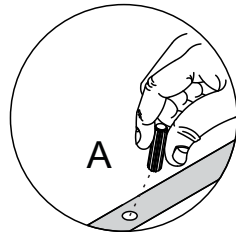
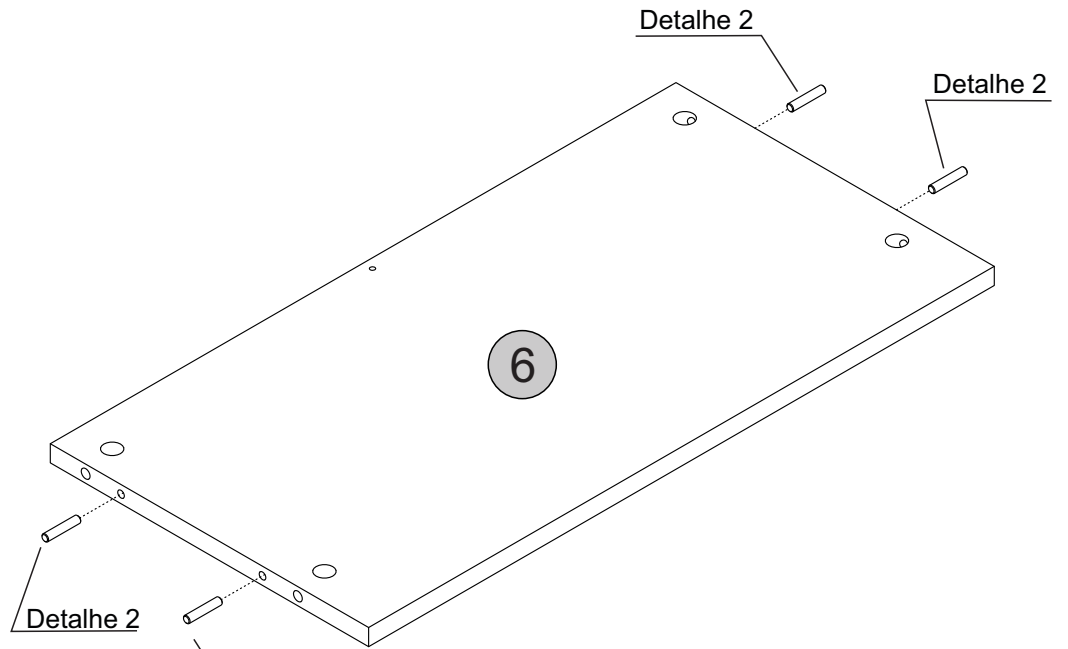
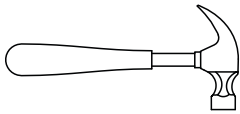

Detalhe 2
Detail/Detalle

Passo 4

Paso/Step

PEÇA

Piece/Pieza

7 - PRATELEIRA SUP. x1

FERRAGEM

Hardware/Herraje

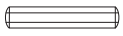
A  04

FERRAMENTA

Tool/Herramienta

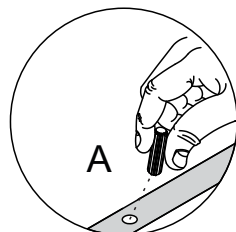
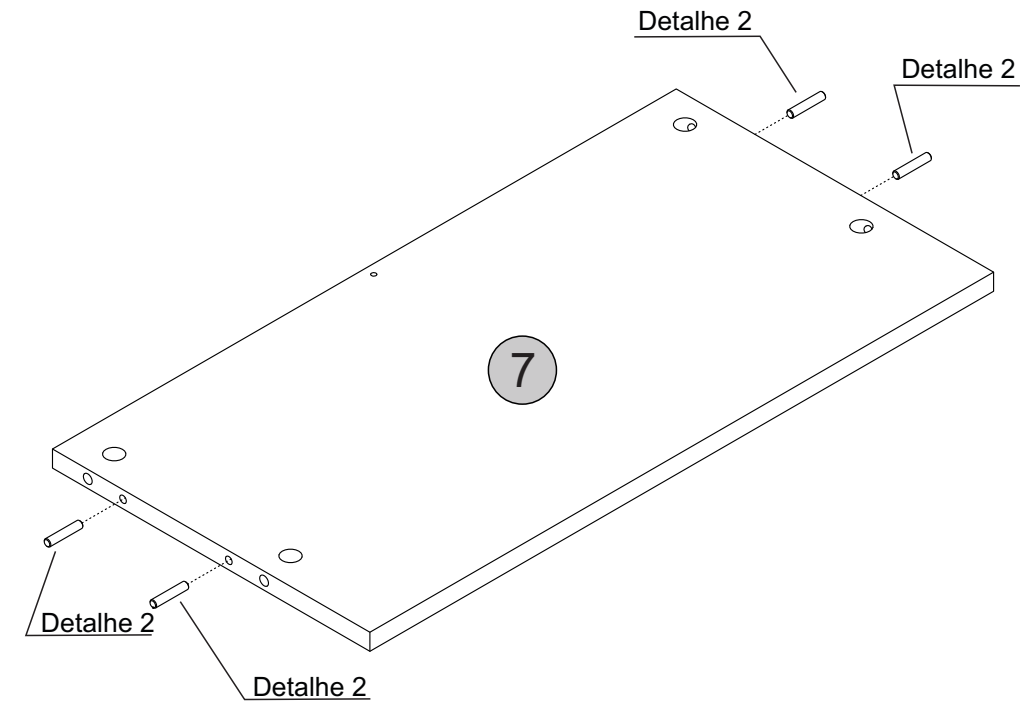
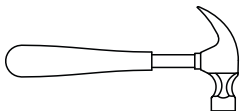

Detalhe 2
Detail/Detalle

Passo 5

Paso/Step

PEÇA

Piece/Pieza

2 - LATERAL ESQUERDA x1

FERRAGEM

Hardware/Herraje

A  02

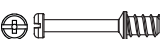
B  16

FERRAMENTA

Tool/Herramienta

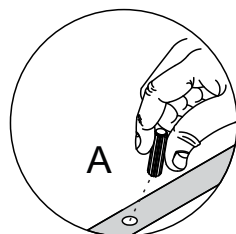
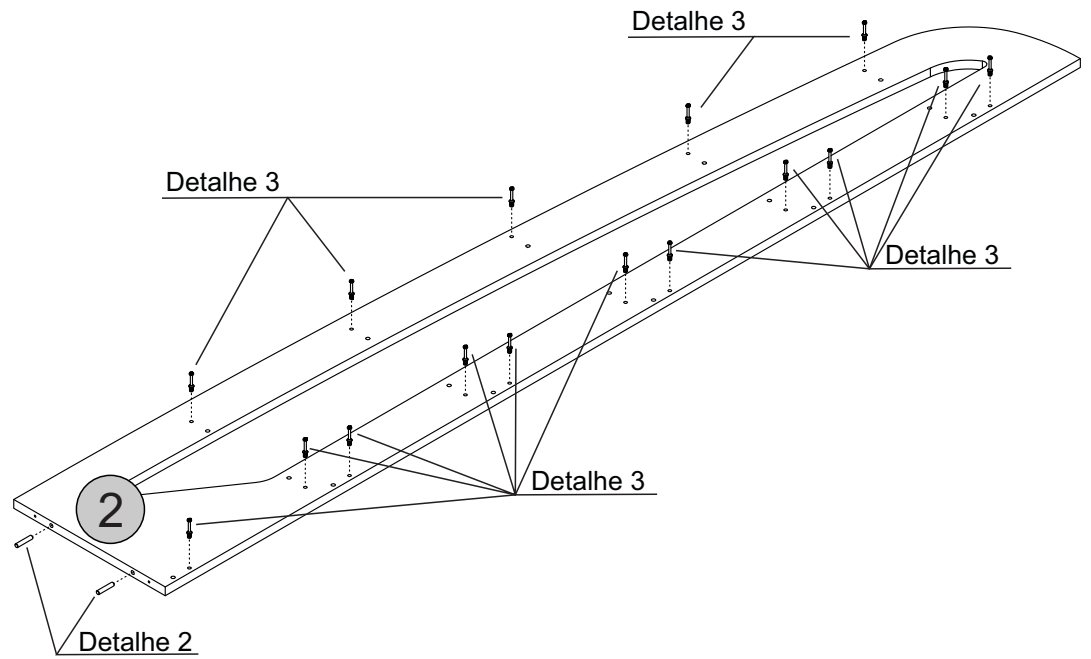
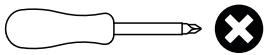

Detalhe 2
Detail/Detalle

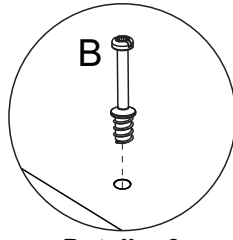

Detalhe 3
Detail/Detalle

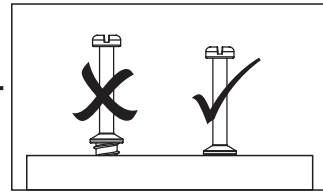

Passo 6

Paso/Step

PEÇA

Piece/Pieza

3 - LATERAL DIREITA x1

FERRAGEM

Hardware/Herraje

A  02

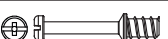
B  16

FERRAMENTA

Tool/Herramienta

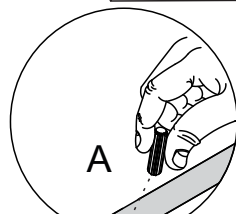
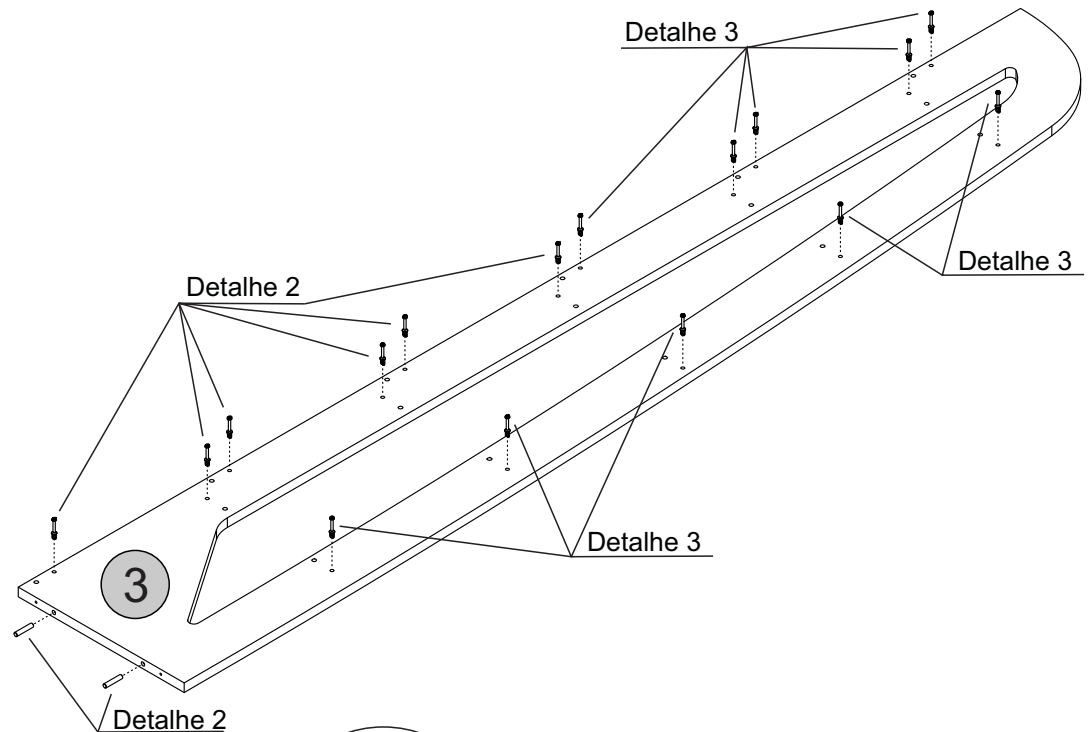
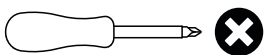

Detalhe 2
Detail/Detalle

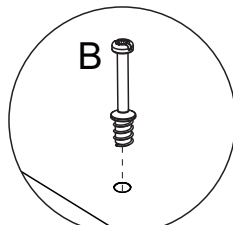

Detalhe 3
Detail/Detalle

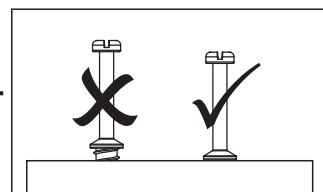

Passo 7

Paso/Step

PEÇA

Piece/Pieza

5 - TRAVESSA x1

7 - PRATELEIRA SUP. x1

FERRAGEM

Hardware/Herraje

C   03

D  03

FERRAMENTA

Tool/Herramienta

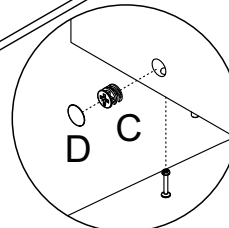
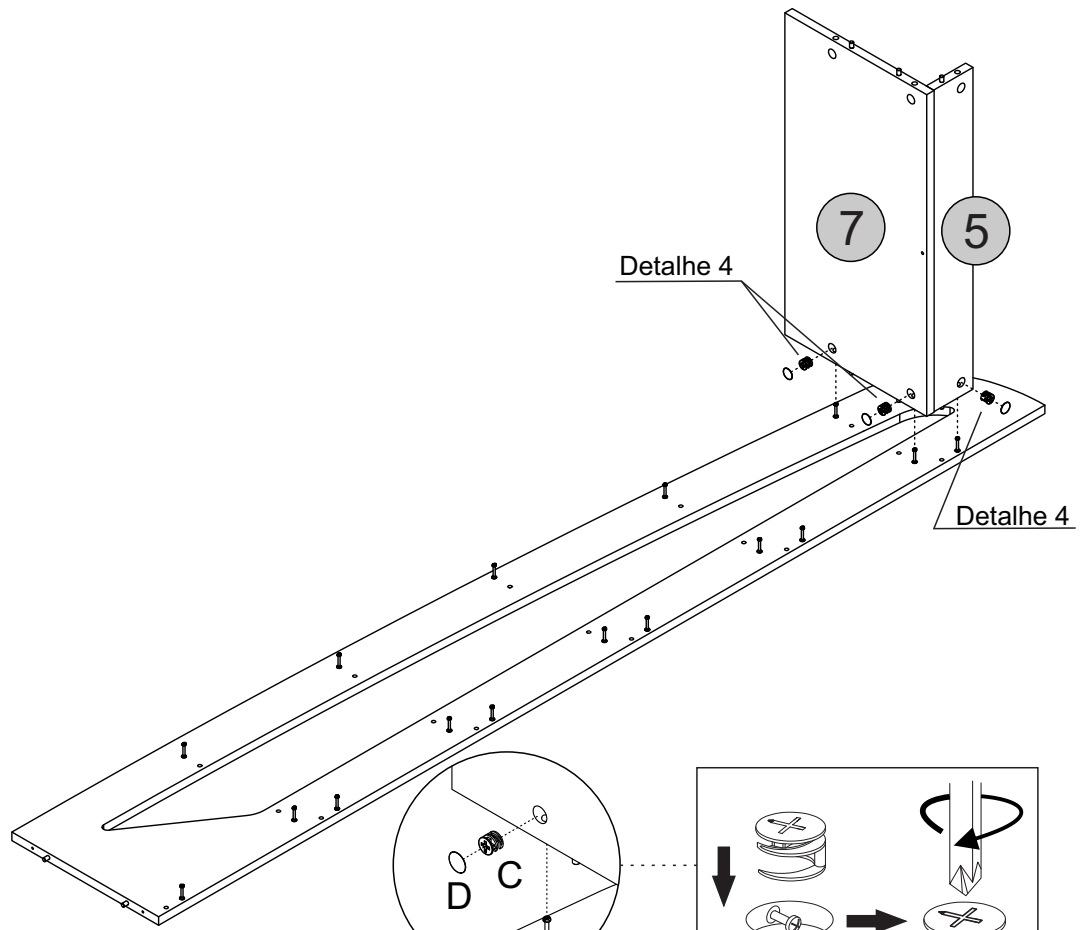
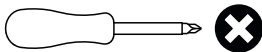

Detalhe 4
Detail/Detalle

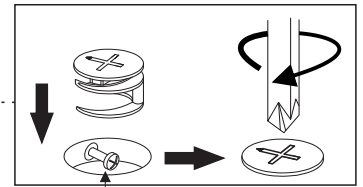

Cabeça do parafuso precisa estar no centro
La cabeza del tornillo debe estar en el centro
Screw head has to be in the center

Passo 8

Paso/Step

PEÇA

Piece/Pieza

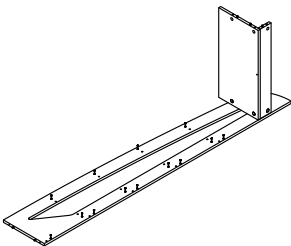

FERRAGEM

Hardware/Herraje

E  01

FERRAMENTA

Tool/Herramienta

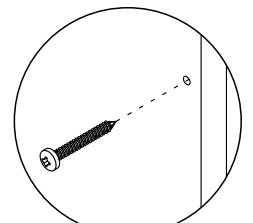
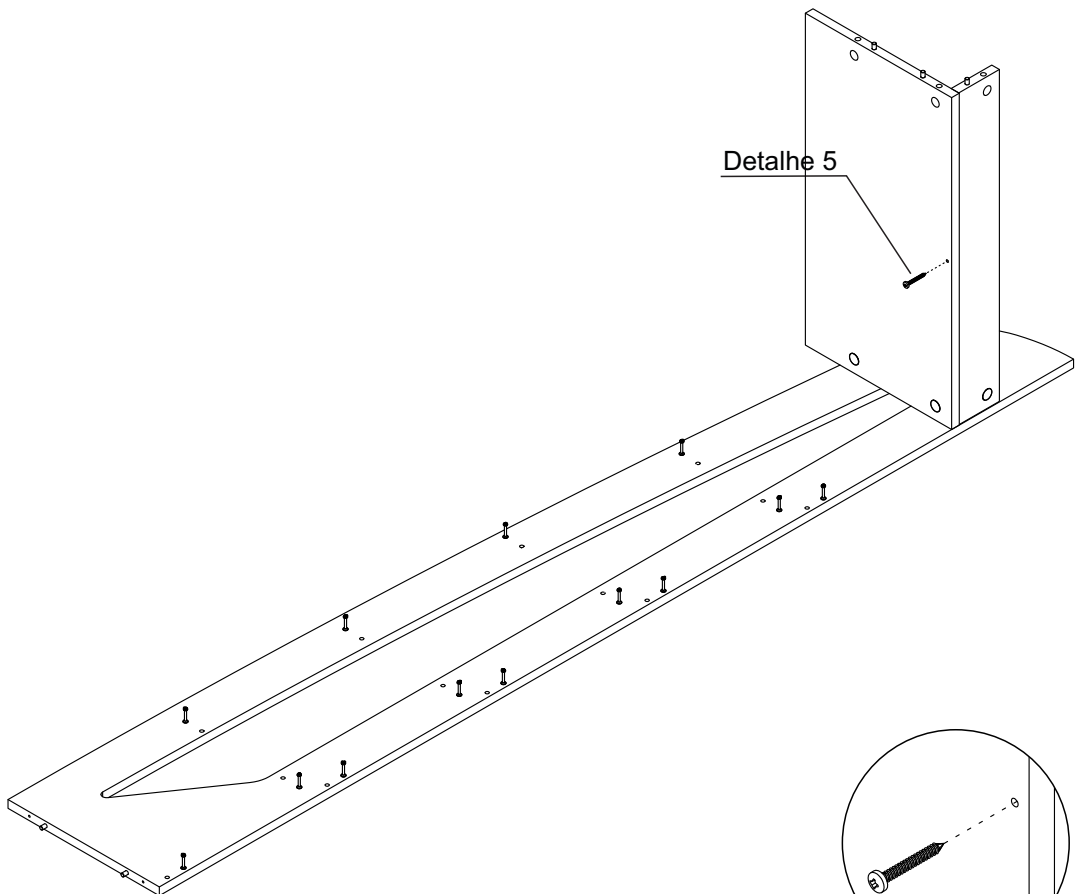
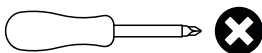

Detalhe 5
Detail/Detalle

Passo 9

Paso/Step

PEÇA

Piece/Pieza

5 - TRAVESSA x1

6 - PRATELEIRA INT. x1

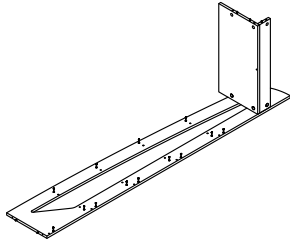

FERRAGEM

Hardware/Herraje

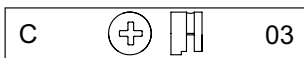

FERRAMENTA

Tool/Herramienta

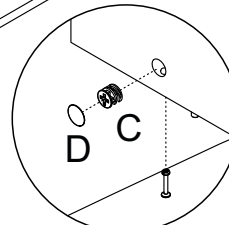
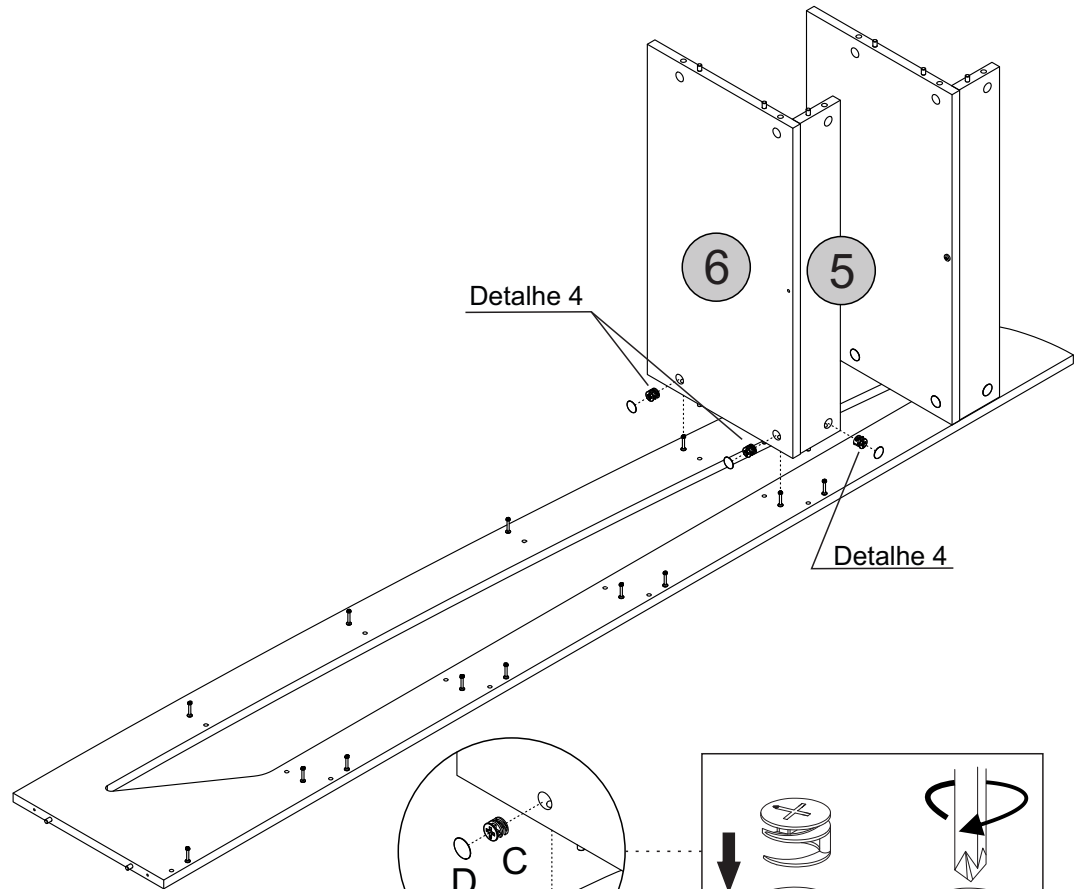
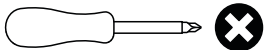

Detalhe 4
Detail/Detalle

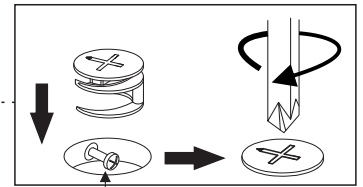

Cabeça do parafuso precisa estar no centro
La cabeza del tornillo debe estar en el centro
Screw head has to be in the center

Passo 10

Paso/Step

PEÇA

Piece/Pieza

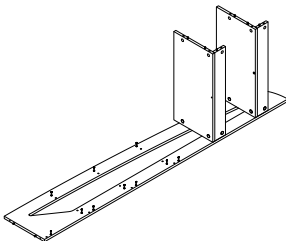

FERRAGEM

Hardware/Herraje



FERRAMENTA

Tool/Herramienta

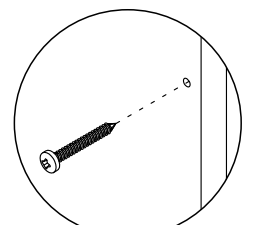
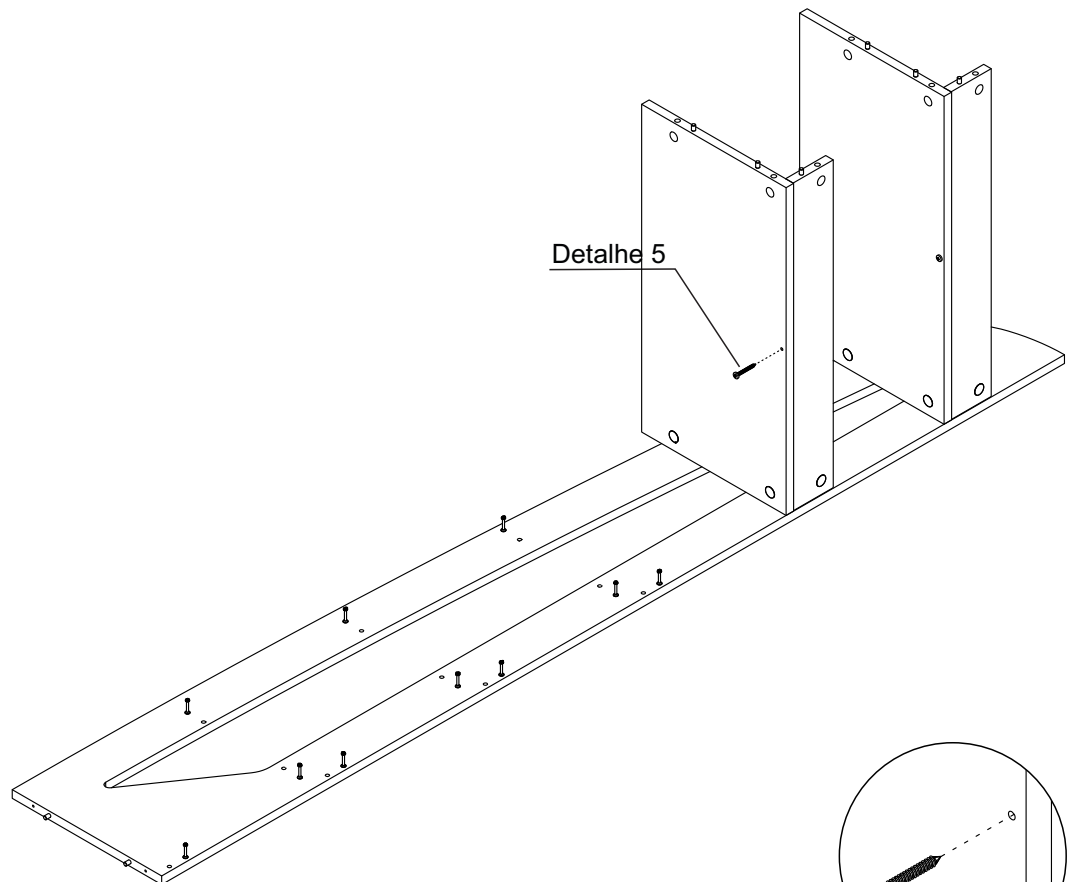
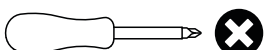

Detalhe 5
Detail/Detalle

Passo 11

Paso/Step

PEÇA
Piece/Pieza

5 - TRAVESSA x1

4 - PRATELEIRA x1

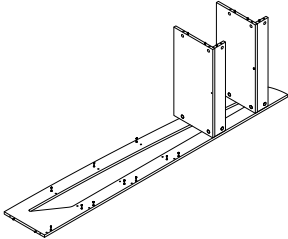

FERRAGEM
Hardware/Herraje

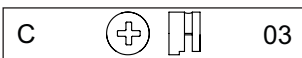

FERRAMENTA
Tool/Herramienta

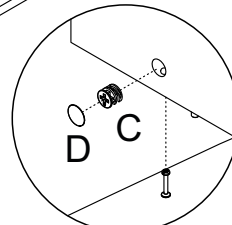
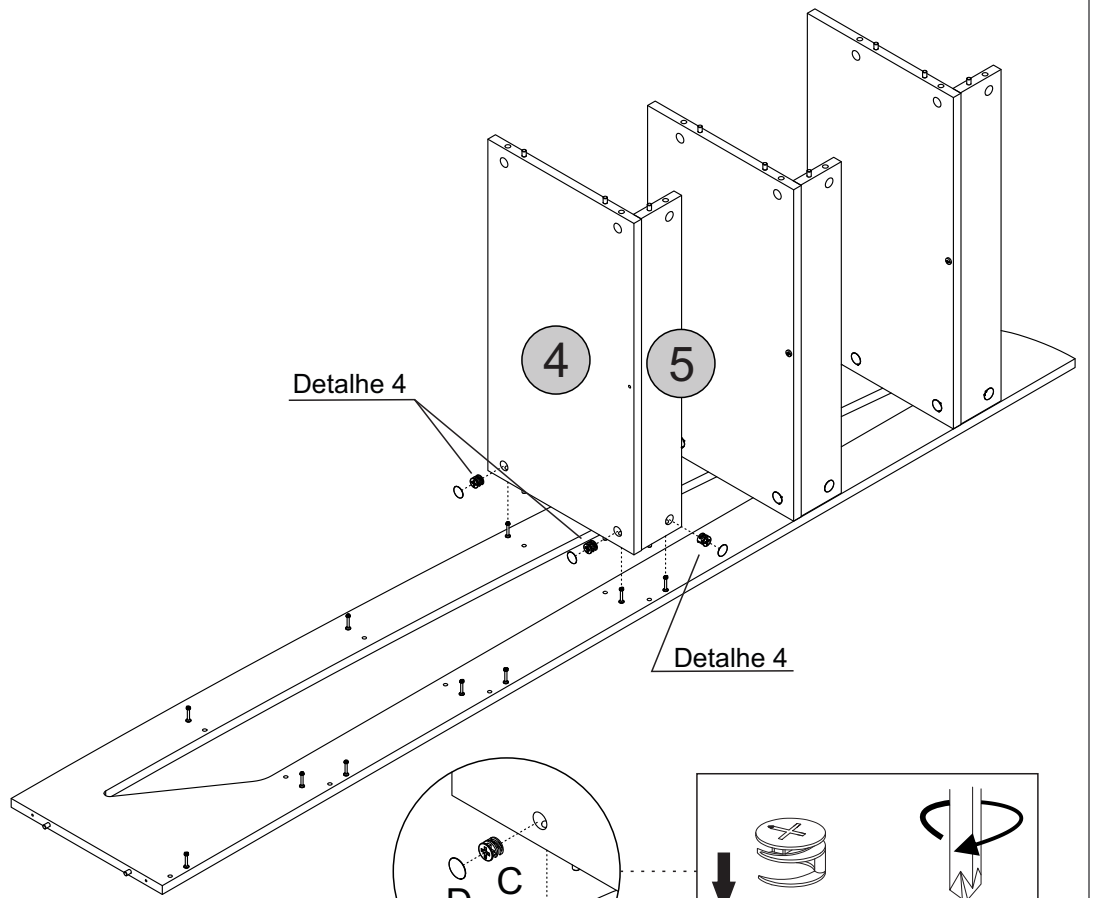
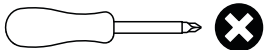

Detalhe 4
Detail/Detalle

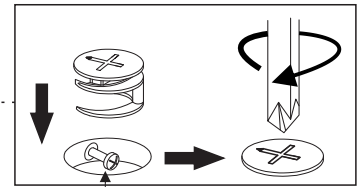

Cabeça do parafuso precisa estar no centro
La cabeza del tornillo debe estar en el centro
Screw head has to be in the center

Passo 12

Paso/Step

PEÇA
Piece/Pieza

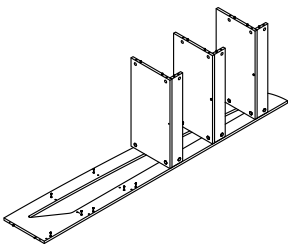

FERRAGEM
Hardware/Herraje



FERRAMENTA
Tool/Herramienta

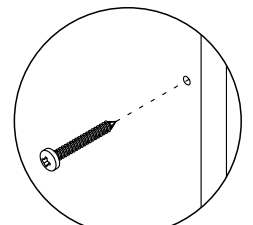
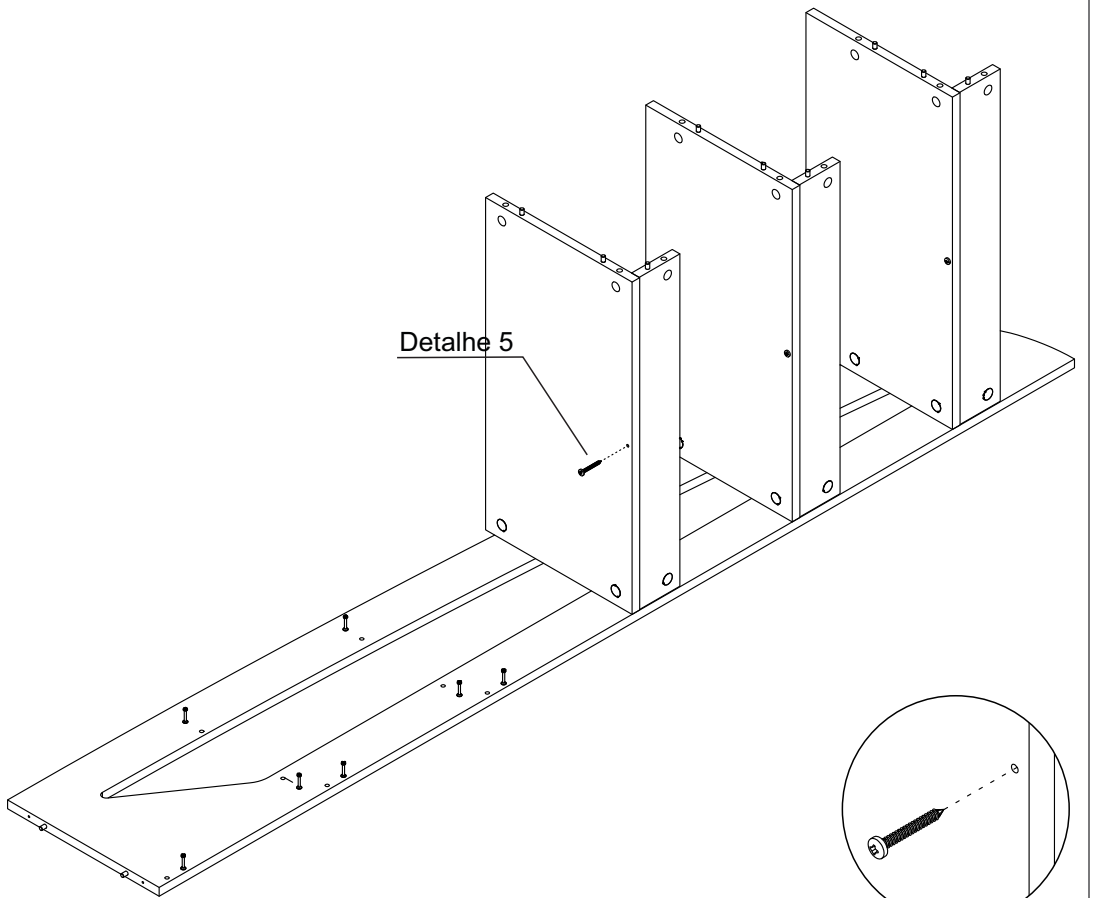
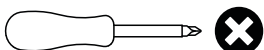

Detalhe 5
Detail/Detalle

Passo 13

Paso/Step

PEÇA

Piece/Pieza

5 - TRAVESSA x1

4 - PRATELEIRA x1

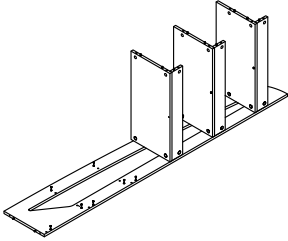

FERRAGEM

Hardware/Herraje

C   03

D  03

FERRAMENTA

Tool/Herramienta

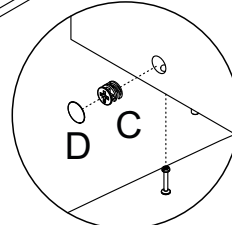
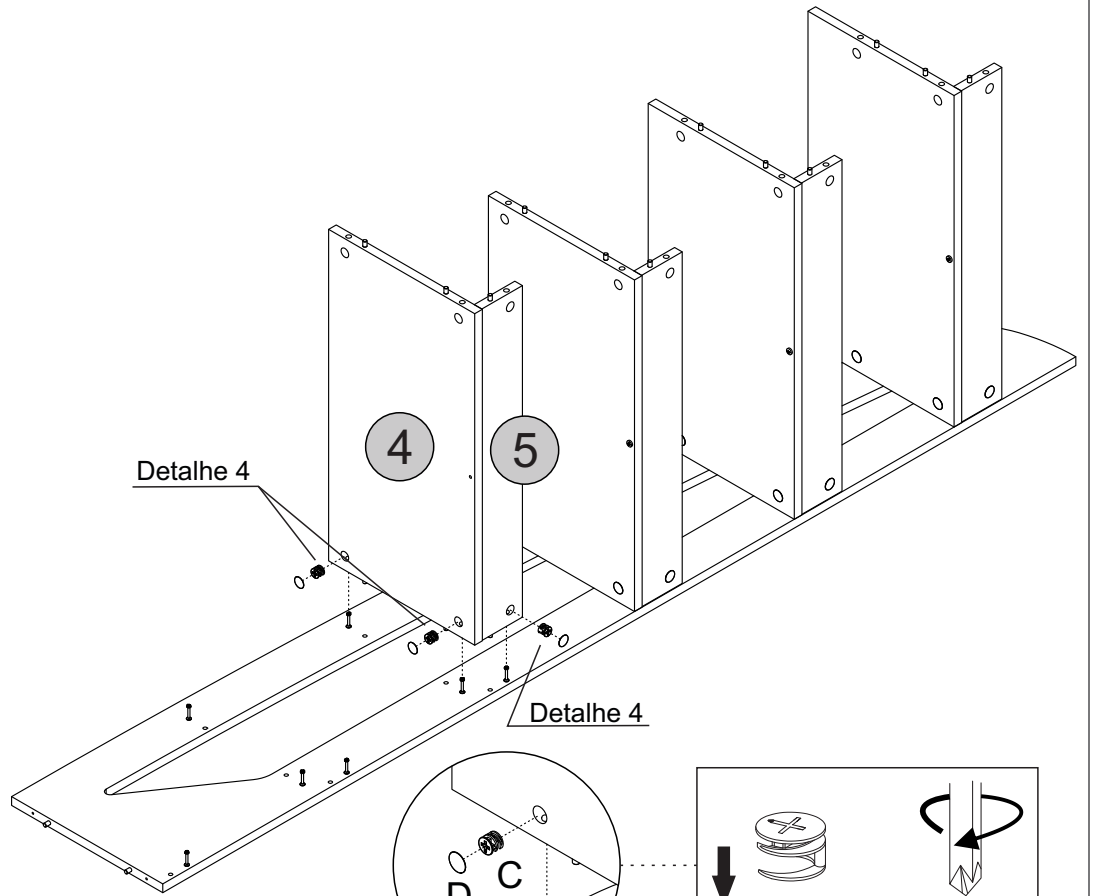
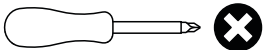

Detalhe 4
Detail/Detalle

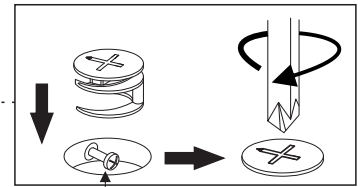

Cabeça do parafuso precisa estar no centro
La cabeza del tornillo debe estar en el centro
Screw head has to be in the center

Passo 14

Paso/Step

PEÇA

Piece/Pieza

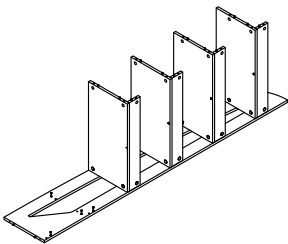

FERRAGEM

Hardware/Herraje

E  01

FERRAMENTA

Tool/Herramienta

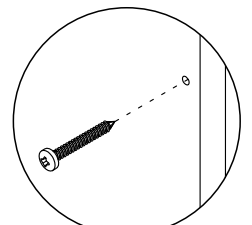
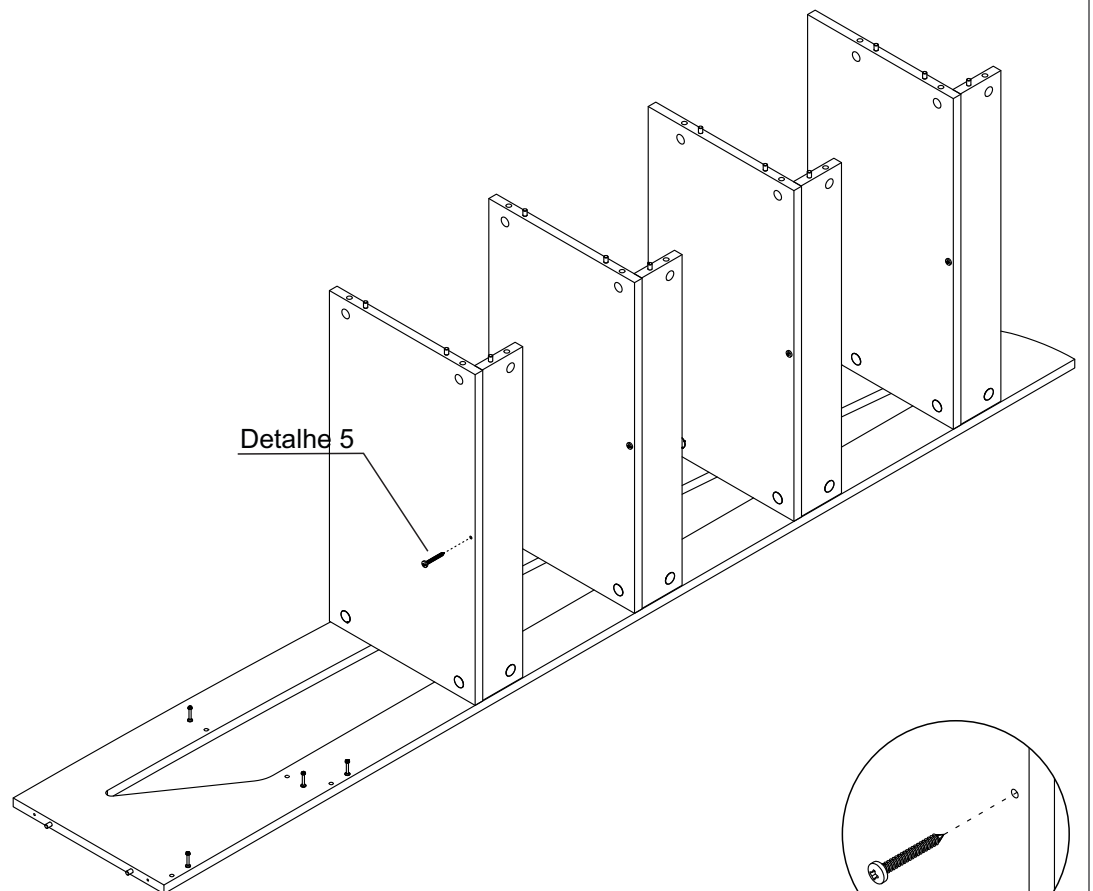
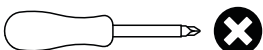

Detalhe 5
Detail/Detalle

Passo 15

Paso/Step

PEÇA
Piece/Pieza

5 - TRAVESSA x1

4 - PRATELEIRA x1

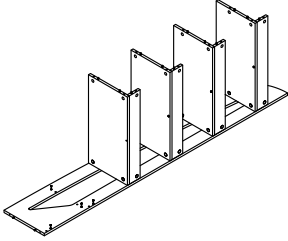

FERRAGEM
Hardware/Herraje

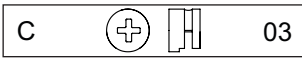

FERRAMENTA
Tool/Herramienta

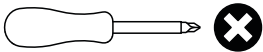

Detalhe 4

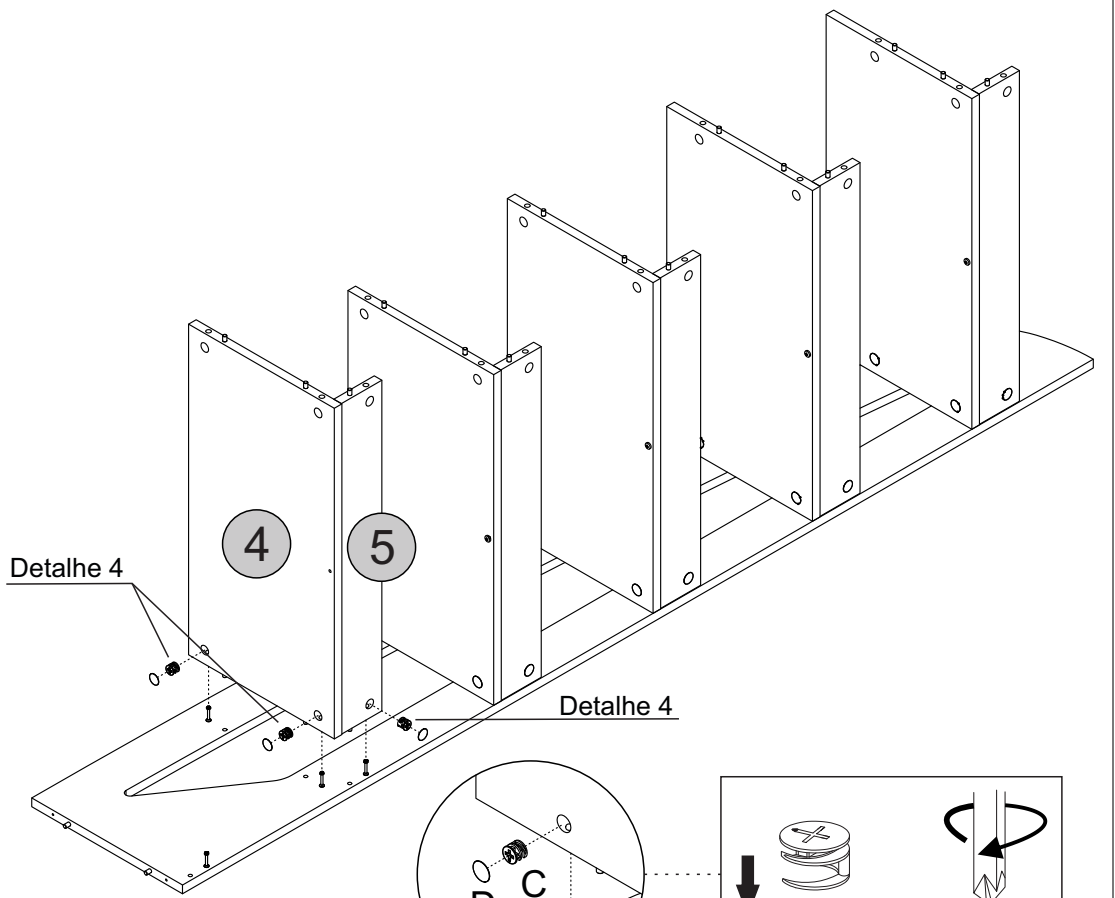

Detalhe 4

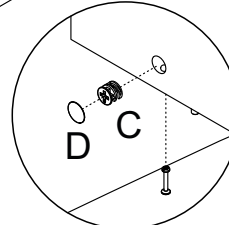

Detalhe 4
Detail/Detalle

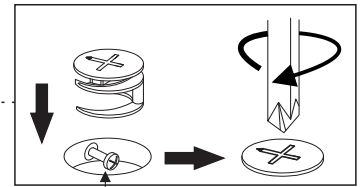

Cabeça do parafuso precisa estar no centro
La cabeza del tornillo debe estar en el centro
Screw head has to be in the center

Passo 16

Paso/Step

PEÇA
Piece/Pieza

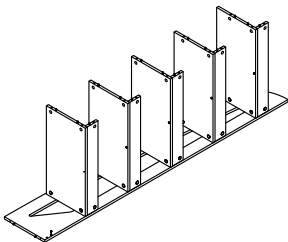

FERRAGEM
Hardware/Herraje



FERRAMENTA
Tool/Herramienta

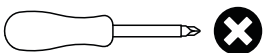

Detalhe 5

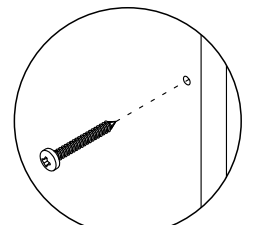
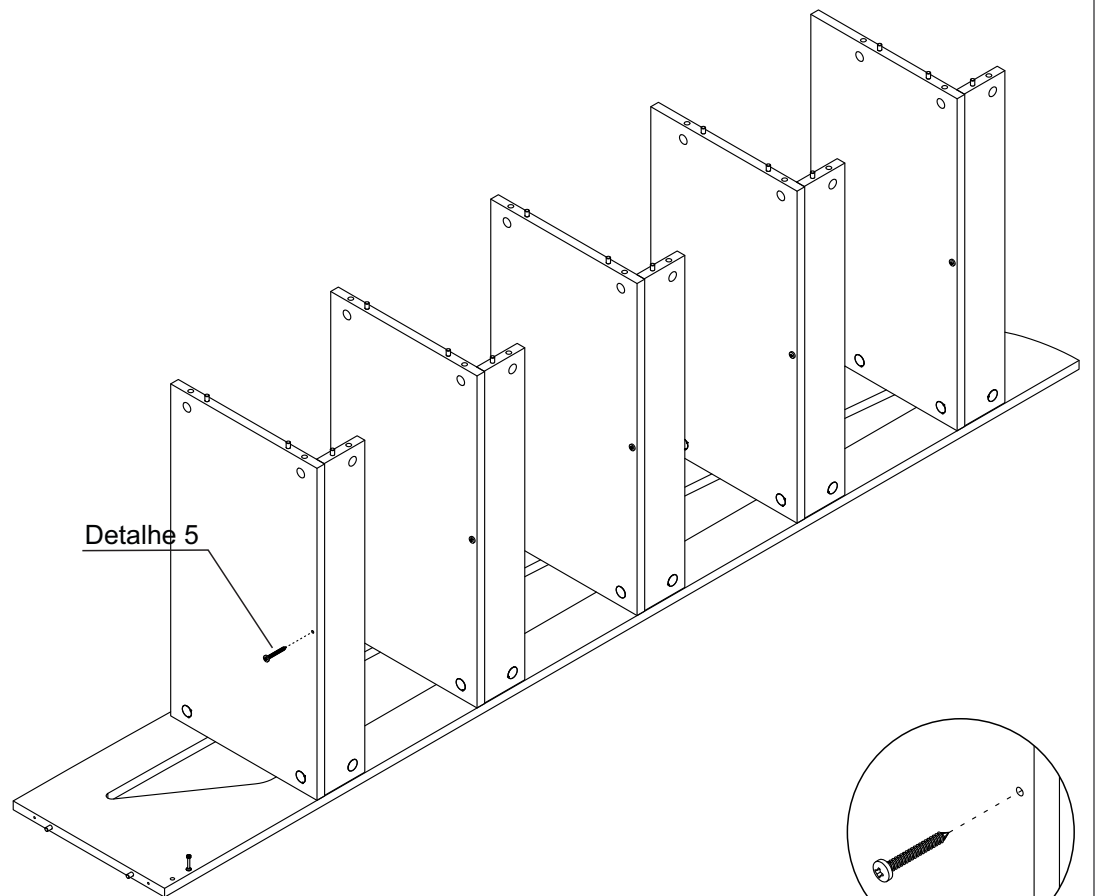

Detalhe 5
Detail/Detalle

Passo 17

Paso/Step

PEÇA

Piece/Pieza

3 - LATERAL DIREITA x1

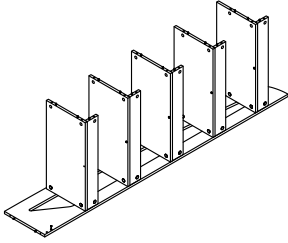

FERRAGEM

Hardware/Herraje

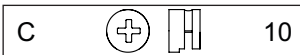

10



10

FERRAMENTA

Tool/Herramienta

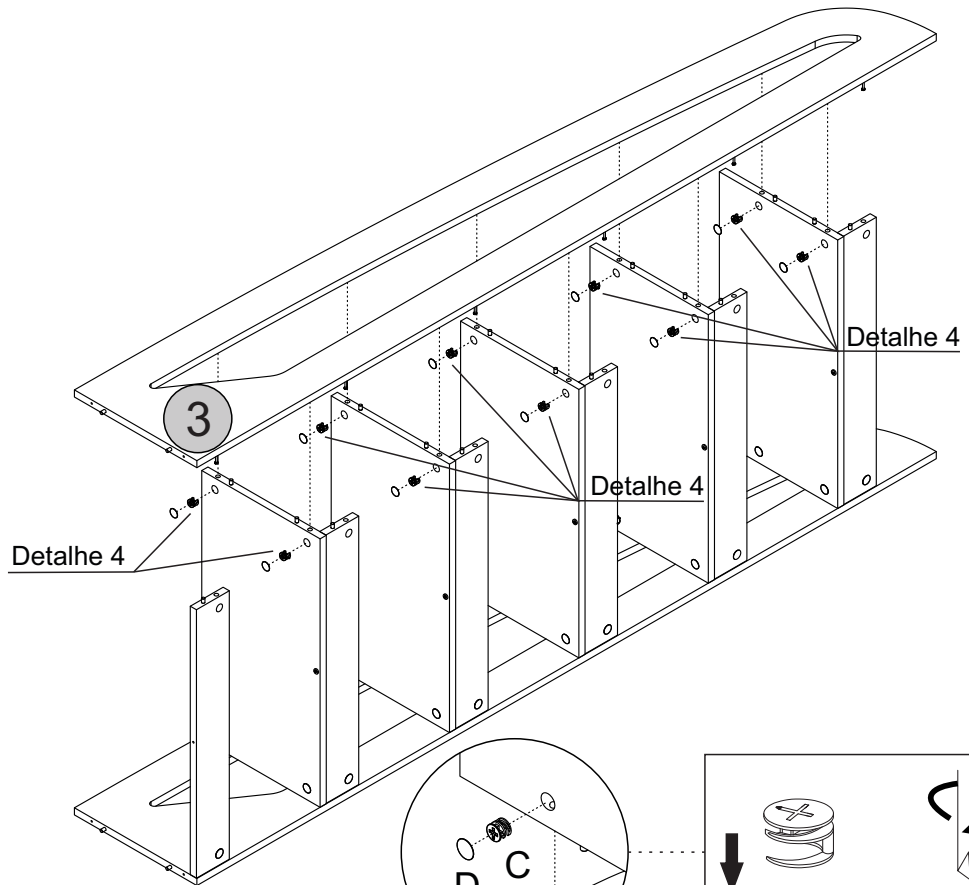
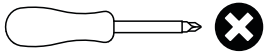

Detalhe 4
Detail/Detalle

Cabeça do parafuso precisa estar no centro
La cabeza del tornillo debe estar en el centro
Screw head has to be in the center

Passo 18

Paso/Step

PEÇA

Piece/Pieza

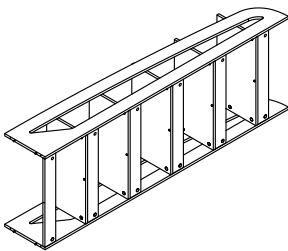

FERRAGEM

Hardware/Herraje

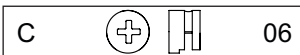

06



06

FERRAMENTA

Tool/Herramienta

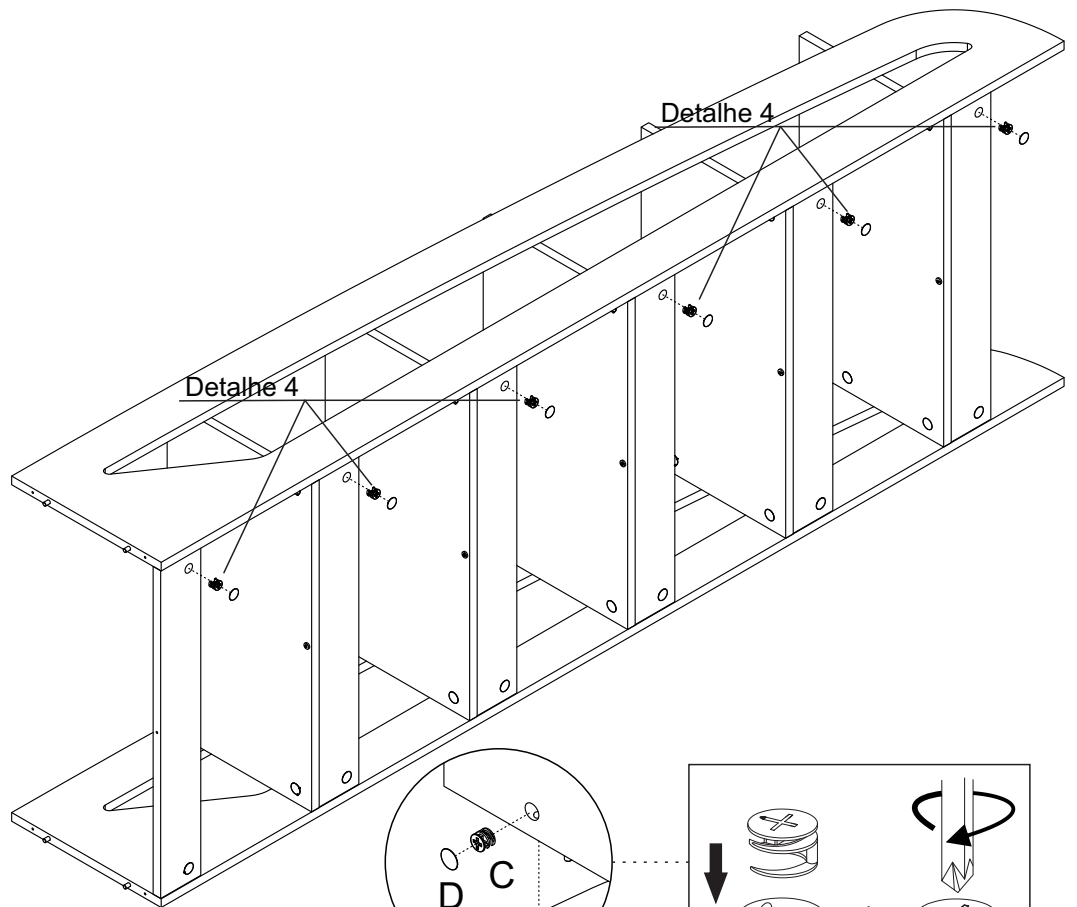
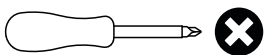

Detalhe 4
Detail/Detalle

Cabeça do parafuso precisa estar no centro
La cabeza del tornillo debe estar en el centro
Screw head has to be in the center

Passo 19

Paso/Step

PEÇA
Piece/Pieza

1 - BASE x1

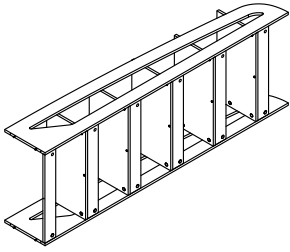

FERRAGEM
Hardware/Herraje

E  05

FERRAMENTA
Tool/Herramienta

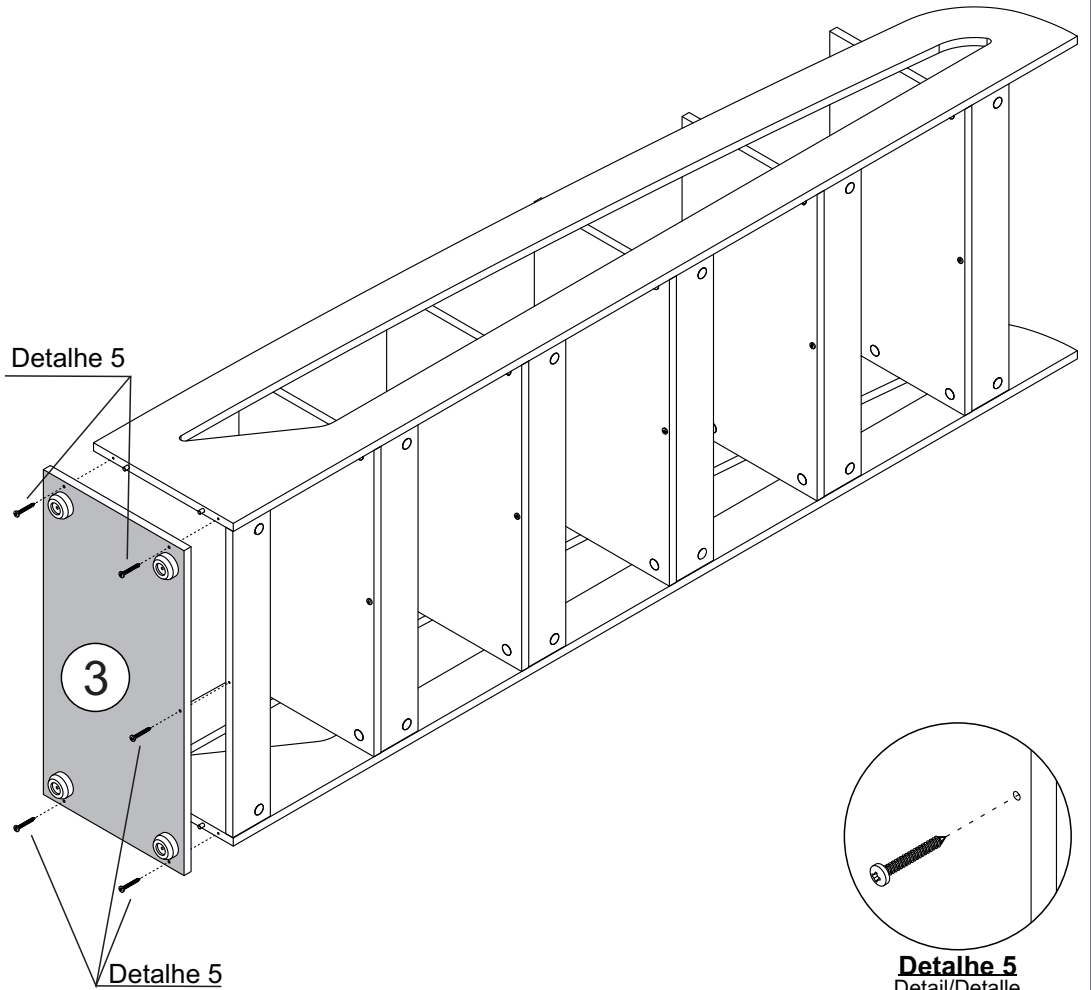
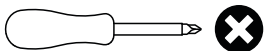

Detalhe 5
Detail/Detalle

Passo 20

Paso/Step

PEÇA
Piece/Pieza

FERRAGEM
Hardware/Herraje

FERRAMENTA
Tool/Herramienta



- O número na borda da peça corresponde ao manual.
- Para retirada do número usar Lustra-Móveis, Alcool em Gel ou Borracha.
- El número en el borde de la pieza coincide con el manual.
- Use una goma de borrar blanca, alcohol en gel o lustrador para muebles para eliminar los números.
- The number on the edge of the piece matches the manual.
- Use a White eraser, Alcohol Gel or Furniture Polish to remove the numbers.

