



JCM
movelaria

Home Amparo
Amparo Entertainment Center
Centro de Entretenimiento Amparo



Cupom: JCM30



















Indicamos que a montagem dos produtos seja realizada com parafusadeira eléctrica e por um montador profissional.
We recommend that a professional furniture assembler assemble the product by using a cordless screwdriver.
Se recomienda que un montador de muebles profesional realice el montaje del producto con un destornillador eléctrico.





























AVISO: Não nos comprometemos pelo mal-uso, montagem e fixação do produto à parede. Portanto, não somos responsáveis por danos e quedas do produto, eletrônicos e pertences neles contidos. É importante o uso de brocas e ferramentas compatíveis na montagem.
NOTICE: The company is not responsible for the misuse, assembly, and wall fixation, as well as the damages and falls that the products, electronics, and belongings therein might suffer. It is important to use suitable drills and tools to assemble the product.
ATENCIÓN: La empresa no se responsabiliza del mal uso, montaje y fijación del producto a la pared, así como de daños y caídas del producto, electrónicos u objetos. Es importante el uso de taladros y herramientas compatibles con el montaje.

Dica: para evitar possíveis avarias, use a embalagem do produto como apoio durante a montagem.
Tip: to avoid damages, use the product packaging as a base during the assembly.
Pista: para evitar daños, use el envase del producto como apoyo durante el montaje.

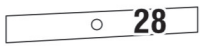
RELAÇÃO DE FERRAGENS | **HARDWARE LIST** | LISTADO DE HERRAJES

BUCHA MINIFIX (C)	MINIFIX INSERT (C)	INSERTO MINIFIX (C)		04
CALÇO DOBRADIÇA (D)	HINGE MOUNTING PLATE (D)	BASE DE BISAGRA (D)		04
CAVILHA 6x30 (E)	6x30 DOWEL (E)	CLAVIJA 6x30 (E)		06
CHAPA UNIAO 4 FUROS (F)	4-HOLE CONNECTION PLATE (F)	PLACA DE UNIÓN 4 AGUJEROS (F)		02
CONEXÃO ANGULAR (G)	CORNER JOINT (G)	SOPORTE ANGULAR (G)		26
DOBRADIÇA ALTA 26mm (H)	26mm HALF OVERLAY HINGE (H)	BISAGRA ACODADA 26 mm (H)		04
FIXADOR METÁLICO (I)	METAL FIXING PLATE (I)	GRAPA METÁLICA (I)		09
PARAFUSO CHP CHA BC 3,5x12 (J)	3.5x12 SCREW (J)	TORNILLO 3.5x12 (J)		08
PARAFUSO CHP CHA BC 3,5x14 (K)	3.5x14 SCREW (K)	TORNILLO 3.5x14 (K)		40
PARAFUSO CHP CHA BC 4x25 (L)	4x25 SCREW (L)	TORNILLO 4x25 (L)		33
PARAFUSO 3,5x30 FLANGEADO (M)	3.5x30 FLANGE SCREW (M)	TORNILLO TIPO FLANGE 3,5x30 (M)		10
PARAFUSO 5x25 FLANGEADO (N)	5x25 FLANGE SCREW (N)	TORNILLO TIPO FLANGE 5x25 (N)		04
PARAFUSO ESTR CHA PHI ZP 5x40 (O)	5x40 SCREW (O)	TORNILLO 5x40 (O)		24
PARAFUSO 3,5x14 FLANGEADO (P)	3.5x14 FLANGE SCREW (P)	TORNILLO TIPO FLANGE 3,5x14 (P)		104
PARAFUSO MINIFIX (S)	MINIFIX BOLT (S)	PERNO MINIFIX (S)		10
PASSA FIO 40mm (T)	40mm CABLE PASS (T)	PASACABLE 40mm (T)		01
PREGO 8x8 C/C (U)	8x8 NAIL (U)	CLAVO 8x8 (U)		40
SAPATA DESLIZANTE (V)	GLIDE (V)	PATÍN (V)		10
SUPORTE P/ VIDRO 6mm (W)	6mm GLASS SHELF SUPPORT (W)	SOPORTE REPSA DE VIDRIO 6mm (W)		04
TAMBOR MINIFIX 12x10mm (X)	12x10mm MINIFIX NUT (X)	TUERCA MINIFIX 12x10mm (X)		10

RELAÇÃO DE PEÇAS | PARTS LIST | LISTADO DE PARTES

	Base Bottom Base	1Pc		Tampo Superior TV Panel Top Tapa Panel de TV	1Pc
	Tampo Intermediário TV Stand Top Tapa Mesa de TV	1Pc		Porta Esquerda Left Door Puerta Izquierda	1Pc
	Rodapé Frontal Front Toe Zócalo Frontal	1Pc		Porta Direita Right Door Puerta Dereita	1Pc
	Rodapé Traseiro Back Toe Zócalo Trasero	1Pc		Painel Lateral Side Panel Panel Lateral	1Pc
	Rodapé Lateral Side Toe Zócalo Lateral	2Pcs		Painel Superior Top Panel Panel Superior	1Pc
	Rodapé Interno Internal Toe Zócalo Interno	1Pc		Régua Painel Fêmea Female Panel Strip Listón Hembra del Panel	1Pc
	Lateral Inferior Esquerda TV Stand Left Side Lateral Izquierdo Mesa de TV	1Pc		Régua Painel Macho/Fêmea Male/Female Panel Strip Listón Macho/Hembra del Panel	1Pc
	Lateral Inferior Direita TV Stand Right Side Lateral Derecho Mesa de TV	1Pc		Régua Painel Macho/Fêmea Furada Male/Female Panel Strip With Hole Listón Macho/Hembra del Panel con Agujero	1Pc
	Divisão inferior Central TV Stand Middle Divider División Central Mesa de TV	1Pc		Régua Painel Fêmea Female Panel Strip Listón Hembra del Panel	1Pc
	Batente Porta Door Stop Batiente de Puerta	1Pc		Costas Inferior Direita TV Stand Lower Back Panel Trasera Inferior Mesa de TV	1Pc
	Divisão inferior Menor TV Stand Shelf Divider División de Repisa Mesa de TV	1Pc		Costas Inferior Esquerda TV Stand Left Back Panel Trasera Inferior Izquierda Mesa de TV	2Pcs
	Prateleira Inferior TV Stand Shelf Repisa Mesa de TV	1Pc		Costas Com Furo TV Stand Back Panel With Hole Trasera con Agujero	1Pc
	Lateral Superior Direita TV Panel Right Side Lateral Derecho del Panel	1Pc		Vidro Glass Shelf Repisa de Vidrio	2Pcs
	Lateral Superior Esquerda TV Panel Left Side Lateral Izquierdo del Panel	1Pc			
	Reforço Superior Central TV Panel Reinforcement Refuerzo Central del Panel	1Pc			
	Régua Reforço Reinforcement Strips Listone de Refuerzo	3Pcs			

PASSO 01 INICIE A MONTAGEM PELA PEÇA 2 ENCAIXANDO NAS PEÇAS 7, 8 E 9 COM MINIFIX (S+X). EM SEGUIDA PARAFUSE A PEÇA 12 NAS PEÇAS 8 E 9 COM PARAFUSO 5x40 (O).

STEP 01 START THE ASSEMBLY FROM PART 2. FASTEN PARTS 7, 8, AND 9 WITH MINIFIX (S+X). THEN FASTEN PART 12 TO PARTS 8 AND 9 WITH 5x40 SCREWS (O).

PASO 01 EMPIECE EL ARMADO POR LA PARTE 2. FIJE LAS PARTES 7, 8 Y 9 CON MINIFIX (S+X). DESPUÉS, FIJE LA PARTE 12 A LAS PARTES 8 Y 9 CON TORNILLOS 5x40 (O).

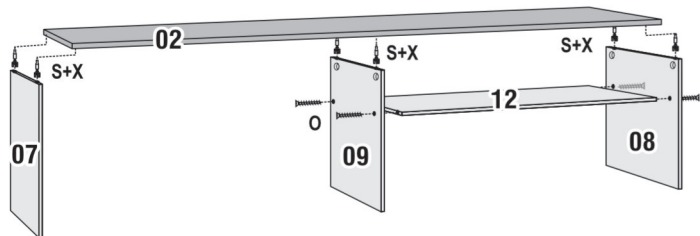

S=6 X=6

O=4

PASSO 02 ENCAIXE A PEÇA 11 NA PEÇA 12 COM CAVILHA 6x30 (E) E A PEÇA 10 NA PEÇA 2 COM CAVILHA 6x30 (E). EM SEGUIDA, ENCAIXE A PEÇA 1 NAS PEÇAS 10 COM CAVILHA 6x30 (E) E PARAFUSE A MESMA NAS PEÇAS 7, 8, 9 E 11 COM PARAFUSO 5x40 (O).

STEP 02 FASTEN PART 11 TO PART 12 WITH 6x30 DOWELS (E). FASTEN PART 10 TO PART 2 WITH 6x30 DOWELS (E). THEN FASTEN PART 1 TO PART 10 WITH 6x30 DOWELS (E), AND TO PARTS 7, 8, 9, AND 11 WITH 5x40 SCREWS (O).

PASO 02 FIJE LA PARTE 11 A LA PARTE 12 CON CLAVIJAS 6x30 (E). FIJE LA PARTE 10 A LA PARTE 2 CON CLAVIJAS 6x30 (E). DESPUÉS, FIJE LA PARTE 1 A LA PARTE 10 CON CLAVIJAS 6x30 (E). FIJE LA PARTE 1 A LAS PARTES 7, 8, 9 Y 11 CON TORNILLOS 5x40 (O).

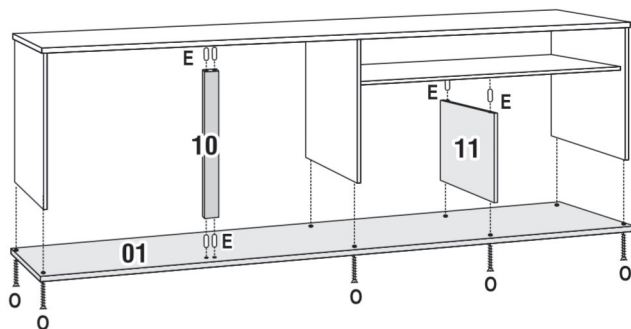

E=6

O=8

PASSO 03 PARAFUSE AS PEÇAS 5 NA PEÇA 1 COM PARAFUSO 5x40 (O). EM SEGUIDA, PARAFUSE/MONTE AS PEÇAS 3, 4 E 6 NA PEÇA 1 COM SUPORTE ANGULAR (G+J), JÁ PARAFUSANDO AS SAPATAS (V+K).

STEP 03 FASTEN PARTS 5 TO PART 1 WITH 5x40 SCREWS (O). THEN ASSEMBLE/FASTEN PARTS 3, 4, AND 6 TO PART 1 WITH CORNER JOINTS (G+J), AND ATTACH THE GLIDES (V+K).

PASO 03 FIJE LAS PARTES 5 A LA PARTE 1 CON TORNILLOS 5x40 (O). DESPUÉS ARME/FIJE LAS PARTES 3, 4 Y 6 A LA PARTE 1 CON SOPORTES ANGULARES (G+J), Y ATORNILLE LOS PATINES (V+K).

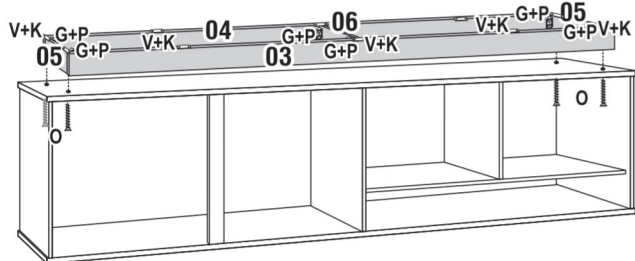

VISTA INFERIOR | BOTTOM VIEW | VISTA DESDE ABAJO

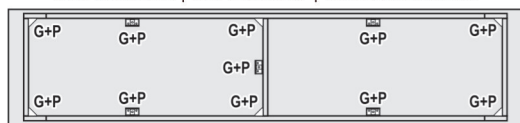

G=11

P=44

K=20

O=4

V=10

PASSO 04 ENCAIXE AS PEÇAS 13 E 14 NA PEÇA 2 COM MINIFIX E BUCHA (C+S+X), E PARAFUSE A PEÇA 15 NA PEÇA 2 COM PARAFUSO 5x40 (O). EM SEGUIDA, PARAFUSE A PEÇA 17 NAS PEÇAS 13, 14 E 15 COM PARAFUSOS 5x40 (O).

STEP 04 FASTEN PARTS 13 AND 14 TO PART 2 WITH MINIFIX AND INSERT (C+S+X). FASTEN PART 15 TO PART 2 WITH 5x40 SCREWS (O). THEN FASTEN PART 17 TO PARTS 13, 14, AND 15 WITH 5x40 SCREWS (O).

PASO 04 FIJE LAS PARTES 13 Y 14 A LA PARTE 2 CON MINIFIX E INSERTOS (C+S+X), Y FIJE LA PARTE 15 A LA PARTE 2 CON TORNILLOS 5x40 (O). DESPUÉS, FIJE LA PARTE 17 A LAS PARTES 13, 14 Y 15 CON TORNILLOS 5x40 (O).

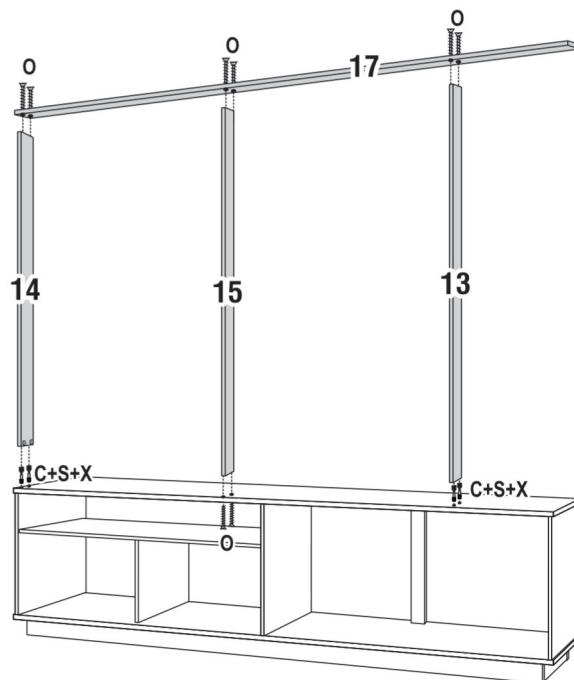

VISTA TRASEIRA
BACK VIEW
VISTA TRASERA

C=4

S=4

X=4

O=8

- PASSO 05 PARAFUSE AS PEÇAS 16 NAS PEÇAS 13, 14 E 15 COM SUPORTE ANGULAR (G+J), E O PAINEL 21 COM PARAFUSO 3,5x30 LANGEADO (M), CONFORME DESENHO ABAIXO.
STEP 05 FASTEN PARTS 16 TO PARTS 13, 14, AND 15 WITH CORNER JOINTS (G+J). FASTEN THE TOP PANEL (21) WITH 3.5x30 FLANGE SCREWS (M), ACCORDING TO THE DRAWING BELOW.
 PASO 05 FIJE LAS PARTES 16 A LAS PARTES 13, 14 Y 15 CON SOPORTES ANGULARES (G+J), Y FIJE EL PANEL SUPERIOR (21) CON TORNILLOS FLANGE 3,5x30 (M), SEGÚN LOS DISEÑOS ABAJO.

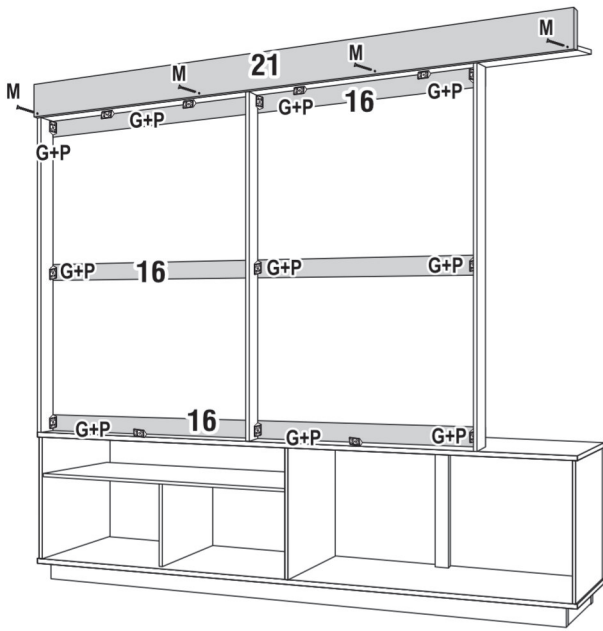

VISTA TRASEIRA
BACK VIEW
 VISTA TRASERA

G = 15 P = 60
 M = 6

- PASSO 06 ENCAIXE E PARAFUSE OS RIPADOS 25, 24, 23 E 22 COM PARAFUSO 4x25 (L).
STEP 06 ATTACH THE SLATTED PANELS 25, 24, 23, AND 22 WITH 4x25 SCREWS (L).
 PASO 06 FIJE LOS LISTONES 25, 24, 23 Y 22 CON TORNILLOS 4x25 (L).

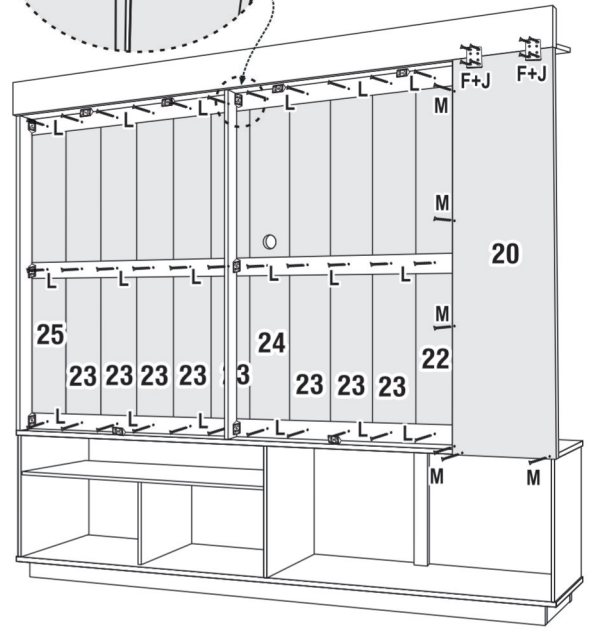
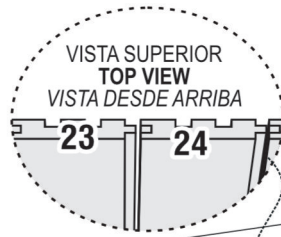

VISTA TRASEIRA
BACK VIEW
 VISTA TRASERA

F = 2 J = 8
 L = 33 M = 6

- PASSO 07 PREGUE AS COSTAS COM PREGO 8x8 (U) E FIXADOR METÁLICO (I+U), CONFORME DESENHO ABAIXO.
STEP 07 NAIL THE BACK WITH 8x8 NAILS (U) AND METAL FIXING PLATES (I+U), ACCORDING TO THE DRAWING BELOW.
 PASO 07 CLAVE LA TRASERA CON CLAVOS 8x8 (U) Y GRAPAS METÁLICAS (I+U), SEGÚN EL DIBUJO ABAJO.

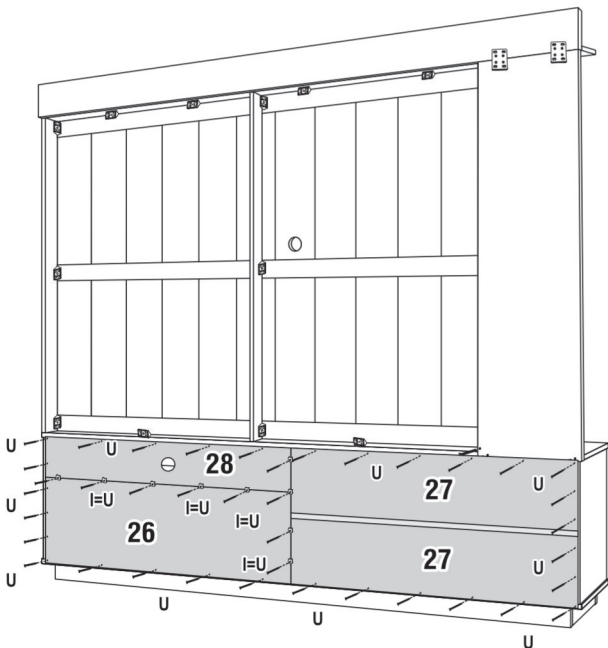

VISTA TRASEIRA
BACK VIEW
 VISTA TRASERA

I = 9 U = 40

- PASSO 08 MONTE E INSTALE AS PORTAS COM AS RESPECTIVAS FERRAGENS, ENCAIXE A LUMINÁRIA, COLOQUE O PASSA-FIO (T) E OS VIDROS COM SUPORTE VIDRO 6mm (W).
STEP 08 ASSEMBLE AND ATTACH THE DOORS WITH THEIR HARDWARE, INSTALL THE LIGHT, INSERT THE CABLE GROMMET (T) AND THE GLASS SHELVES WITH THEIR 6mm SUPPORTS (W).
 PASO 08 ARME E INSTALE LAS PUERTAS CON SUS HERRAJES, INSTALE LA LUZ, PONGA EL PASACABLES (T) Y LAS REPISAS DE VIDRIO CON SUS SOPORTES DE 6 mm (W).

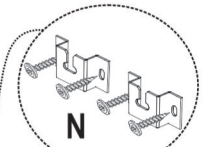
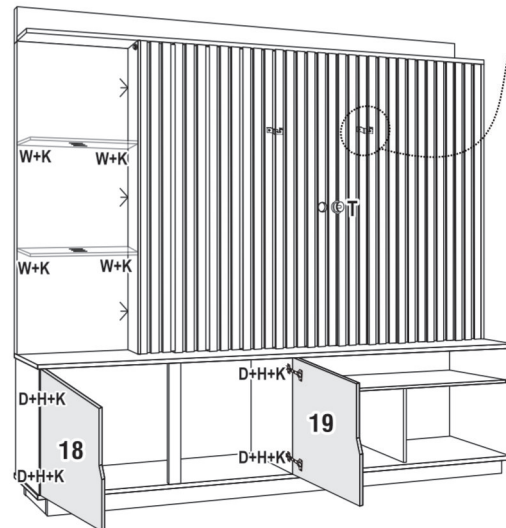

SIGA AS ORIENTAÇÕES QUE SE ENCONTRAM DENTRO DO KIT DO SUPORTE. FOLLOW THE INSTRUCTIONS THAT ARE INSIDE THE TV RACK KIT. SIGA LAS INSTRUCCIONES QUE SE ENCUENTRAN EN EL KIT DEL SOPORTE DE TV.

AO FIXAR O SUPORTE NA TV, PARAFUSOS PODEM SOBRRAR, DEPENDENDO DO TAMAHO DA TV. WHEN FASTENING THE TV RACK, SOME SCREWS MAY BE LEFT, DEPENDING ON THE TV SIZE. AL FIJAR EL SOPORTE DE TV, ALGUNOS TORNILLOS PUEDEN SOBRRAR, DEPENDIENDO DEL TAMAHO DE LA TV.

D = 4 H = 4 K = 20
 N = 4 T = 1 W = 4