



JCM
movelaria

Home Balsamo
Balsamo Entertainment Center
Centro de Entretenimiento Balsamo



Cupom: JCM30



















Indicamos que a montagem dos produtos seja realizada com parafusadeira eléctrica e por um montador profissional.
We recommend that a professional furniture assembler assemble the product by using a cordless screwdriver.
Se recomienda que un montador de muebles profesional realice el montaje del producto con un destornillador eléctrico.

AVISO: Não nos comprometemos pelo mal-uso, montagem e fixação do produto à parede. Portanto, não somos responsáveis por danos e quedas do produto, eletrônicos e pertences neles contidos. É importante o uso de brocas e ferramentas compatíveis na montagem.
NOTICE: The company is not responsible for the misuse, assembly, and wall fixation, as well as the damages and falls that the products, electronics, and belongings therein might suffer. It is important to use suitable drills and tools to assemble the product.
ATENCIÓN: La empresa no se responsabiliza del mal uso, montaje y fijación del producto a la pared, así como de daños y caídas del producto, electrónicos u objetos. Es importante el uso de taladros y herramientas compatibles con el montaje.

Dica: para evitar possíveis avarias, use a embalagem do produto como apoio durante a montagem.
Tip: to avoid damages, use the product packaging as a base during the assembly.
Pista: para evitar daños, use el envase del producto como apoyo durante el montaje.

RELAÇÃO DE FERRAGENS | **HARDWARE LIST** | LISTADO DE HERRAJES

BUCHA MINIFIX (C)	MINIFIX INSERT (C)	INSERTO MINIFIX (C)		04
CALÇO DOBRADIÇA (D)	HINGE MOUNTING PLATE (D)	BASE DE BISAGRA (D)		04
CAVILHA 6x30 (E)	6x30 DOWEL (E)	CLAVIJA 6x30 (E)		04
CHAPA UNIAO 4 FUROS (F)	4-HOLE CONNECTION PLATE (F)	PLACA DE UNIÓN 4 AGUJEROS (F)		10
CONEXÃO ANGULAR (G)	CORNER JOINT (G)	SOPORTE ANGULAR (G)		22
DOBRADIÇA ALTA 26mm (H)	26mm HALF OVERLAY HINGE (H)	BISAGRA ACODADA 26 mm (H)		04
FIXADOR METÁLICO (I)	METAL FIXING PLATE (I)	GRAPA METÁLICA (I)		12
PARAFUSO CHP CHA BC 3,5x14 (J)	3.5x14 SCREW (J)	TORNILLO 3.5x14 (J)		64
PARAFUSO 3,5x35 FLANGEADO (K)	3.5x35 FLANGE SCREW (K)	TORNILLO TIPO FLANGE 3,5x35 (K)		02
PARAFUSO 5x25 FLANGEADO (L)	5x25 FLANGE SCREW (L)	TORNILLO TIPO FLANGE 5x25 (L)		04
PARAFUSO ESTR CHA PHI ZP 5x40 (M)	5x40 SCREW (M)	TORNILLO 5x40 (M)		22
PARAFUSO ESTR CHA PHI ZP 5x50 (N)	5x50 SCREW (N)	TORNILLO 5x50 (N)		02
PARAFUSO ESC PHI ZP/BC 7x60 (O)	7x60 SCREW (O)	TORNILLO 7x60 (O)		02
PARAFUSO 3,5x14 FLANGEADO (P)	3,5x14 FLANGE SCREW (P)	TORNILLO TIPO FLANGE 3,5x14 (P)		88
PARAFUSO MINIFIX (S)	MINIFIX BOLT (S)	PERNO MINIFIX (S)		12
PASSA FIO 40mm (T)	40mm CABLE PASS (T)	PASACABLE 40mm (T)		01
PREGO 8x8 C/C (U)	8x8 NAIL (U)	CLAVO 8x8 (U)		45
PUXADOR DIAMANTE (V)	HANDLE (V)	TIRADOR (V)		02
SAPATA DESLIZANTE (W)	GLIDE (W)	PATÍN (W)		04
TAMBOR MINIFIX 12x10mm (X)	12x10mm MINIFIX NUT (X)	CAJA DEL MINIFIX 12x10mm (X)		12

RELAÇÃO DE PEÇAS | PARTS LIST | LISTADO DE PARTES



01 Pé
Leg
Pata 2Pcs

02

Rodapé Lateral
Side Toe 2Pcs
Zócalo Lateral

03

Rodapé Interno
Internal Toe 1Pc
Zócalo Interno



04 Base
Bottom
Base 1Pc

05

Lateral Inferior Esquerda
TV Stand Left Side 1Pc
Lateral Izquierdo Mesa de TV



06 Lateral Inferior Direita
TV Stand Right Side 1Pc
Lateral Derecho Mesa de TV

07

Divisão inferior Esquerda
TV Stand Left Divider 1Pc
División Izquierda Mesa de TV



08 Divisão inferior Direita
TV Stand Right Divider 1Pc
División Derecha Mesa de TV

09

Divisão inferior Central
TV Stand Shelf Divider 1Pc
División de Repisa Mesa de TV



10 Prateleira Inferior
TV Stand Shelf 1Pc
Repisa Central



11 Painel Inferior
Lower Panel 1Pc
Panel Inferior

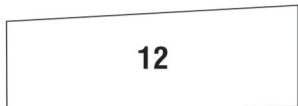

12 Painel Central
Middle Panel 1Pc
Panel Central



13 Painel Superior
Upper Panel 1Pc
Panel Superior



14 Lateral Superior Direita
TV Panel Right Side 1Pc
Lateral Derecho del Panel

15

Lateral Superior Esquerda
TV Panel Left Side 1Pc
Lateral Izquierdo del Panel



16 Reforço Superior Painel
TV Panel Reinforcement 1Pc
Refuerzo Panel de TV

17

Tampo Superior
TV Panel Top 1Pc
Tapa del Panel de TV

18

Porta
Door 2Pcs
Puerta

19

Tampo Meio
TV Stand Top 1Pc
Taap de la Mesa de TV

20

Prateleira Superior
Top Shelf 1Pc
Repisa Superior

21

Painel Ripado
Slatted Panel 1Pc
Panel Alistonado

22

Costas Com Furo
Back Panel With Hole 1Pc
Trasera con Agujero

23

Costas Inferior
TV Stand Lower Back Panel 1Pc
Trasera Inferior Mesa de TV

24

Costas Lateral
TV Stand Side Back Panel 2Pcs
Trasera Laterale Mesa de TV

PASSO 01 INICIE A MONTAGEM PELA PEÇA 19, ENCAIXANDO E FIXANDO AS PEÇAS 5, 6, 7 E 8 COM MINIFIX (S+X).
STEP 01 START THE ASSEMBLY FROM PART 19. FASTEN PARTS 5, 6, 7, AND 8 WITH MINIFIX (S+X).
 PASO 01 EMPIECE EL ARMADO POR LA PARTE 19. FIJE LAS PARTES 5, 6, 7 Y 8 CON MINIFIX (S+X).

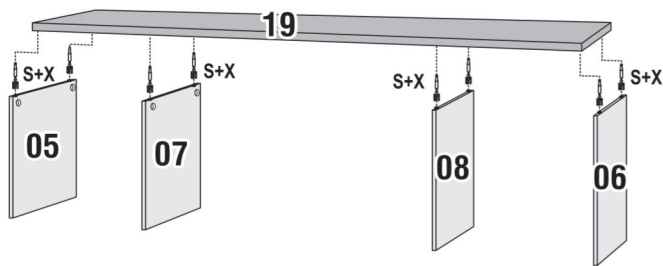

S = 8 X = 8

PASSO 02 PARAFUSE A PEÇA 10 NAS PEÇAS 7 E 8 COM PARAFUSOS 5x40 (M). EM SEGUIDA, ENCAIXE A PEÇA 9 NA PEÇA 10 COM CAVILHA 6x30 (E).

STEP 02 FASTEN PART 10 TO PARTS 7 AND 8 WITH 5x40 SCREWS (M). THEN FASTEN PART 9 TO PART 10 WITH 6x30 DOWELS (E).

PASO 02 FIJE LA PARTE 10 A LAS PARTES 7 Y 8 CON TORNILLOS 5x40 (M). DESPUÉS, FIJE LA PARTE 9 A LA PARTE 10 CON CLAVIJAS 6x30 (E).

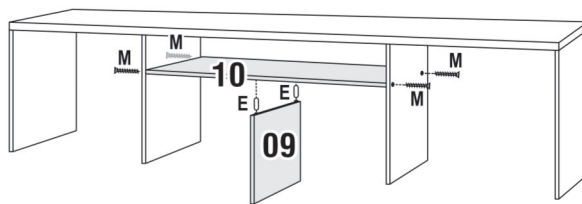

E = 2 M = 4

PASSO 03 ENCAIXE A PEÇA 4 NA PEÇA 9 COM CAVILHA 6x30 (E). EM SEGUIDA, PARAFUSE A PEÇA 4 NAS PEÇAS 5, 6, 7 E 8 COM PARAFUSO 5x40 (M).

STEP 03 FASTEN PART 4 TO PART 9 WITH 6x30 DOWELS (E). THEN FASTEN PART 4 TO PARTS 5, 6, 7, AND 8 WITH 5x40 SCREWS (M).

PASO 03 FIJE LA PARTE 4 A LA PARTE 9 CON CLAVIJAS 6x30 (E). DESPUÉS, FIJE LA PARTE 4 A LAS PARTES 5, 6, 7 Y 8 CON TORNILLOS 5x40 (M).

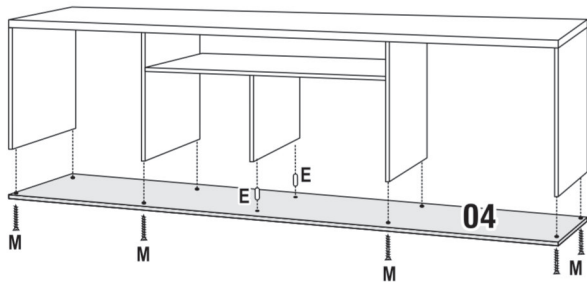

E = 2 M = 8

PASSO 04 PARAFUSE AS PEÇAS 2 NA PEÇA 4 COM PARAFUSO 5x40 (M). EM SEGUIDA, PARAFUSE A PEÇA 3 NA PEÇA 4 COM SUPORTE ANGULAR (G+J).

STEP 04 FASTEN PARTS 2 TO PART 4 WITH 5x40 SCREWS (M). THEN FASTEN PART 3 TO PART 4 WITH CORNER JOINTS (G+J).

PASO 04 FIJE LAS PARTES 2 A LA PARTE 4 CON TORNILLOS 5x40 (M). DESPUÉS FIJE LA PARTE 3 A LA PARTE 4 CON SOPORTES ANGULARES (G+J).

VISTA INFERIOR

?????

?????

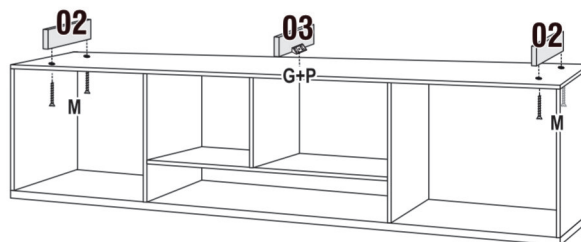

G = 1 M = 4 P = 4

PASSO 05 PARAFUSE AS PEÇAS 1 NAS PEÇAS 2, 3 E 4 COM SUPORTE ANGULAR (G+J), CONFORME DESENHO ABAIXO.

STEP 05 FASTEN PARTS 1 TO PARTS 2, 3, AND 4 WITH CORNER JOINTS (G+J), ACCORDING TO THE DRAWINGS BELOW.

PASO 05 FIJE LAS PARTES 1 A LAS PARTES 2, 3 Y 4 CON SOPORTES ANGULARES (G+J). SEGÚN LOS DIBUJOS ABAJO.

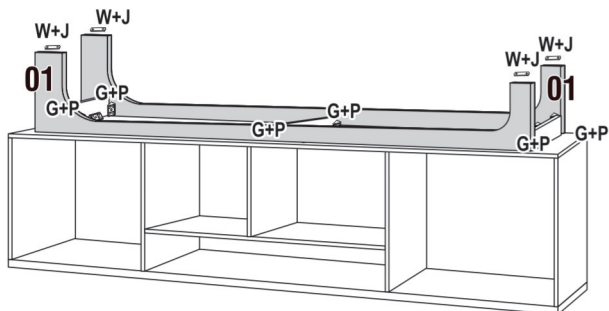

VISTA INFERIOR | BOTTOM VIEW | VISTA DESDE ABAJO

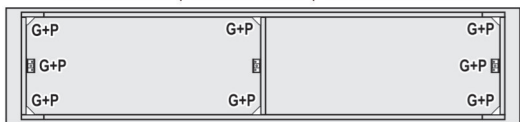

G = 9 J = 8 P = 36 W = 4

PASSO 06 ENCAIXE AS PEÇAS 14 E 15 NA PEÇA 19 E COM MINIFIX E BUCHA (C+S+X), E PARAFUSE A PEÇA 16 TAMBÉM NA PEÇA 19 COM PARAFUSO 5x50 (N). EM SEGUIDA, PARAFUSE A PEÇA 17 NAS PEÇAS 14, 15 E 16 COM PARAFUSO 5x40 (M).

STEP 06 FASTEN PARTS 14 AND 15 TO PART 19 WITH MINIFIX AND INSERT (C+S+X). FASTEN PART 16 TO PART 19 WITH 5x50 SCREWS (N). THEN FASTEN PART 17 TO PARTS 14, 15, AND 16 WITH 5x40 SCREWS (M).

PASO 06 FIJE LAS PARTES 14 Y 15 A LA PARTE 19 CON MINIFIX E INSERTOS (C+S+X), Y FIJE LA PARTE 16 A LA PARTE 19 CON TORNILLOS 5x50 (N). DESPUÉS, FIJE LA PARTE 17 A LAS PARTES 14, 15 Y 16 CON TORNILLOS 5x40 (M).

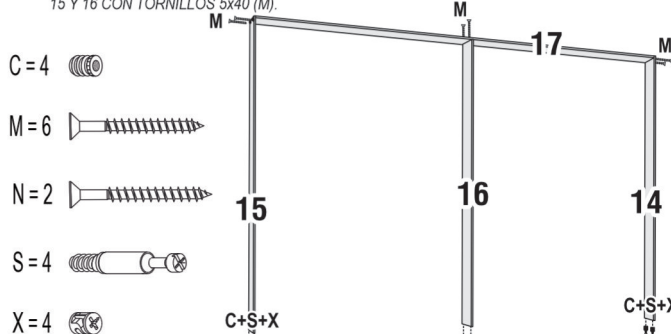

VISTA TRASEIRA
 BACK VIEW
 VISTA TRASERA

PASSO 07 PARAFUSE OS PANÉIS RIPADOS 21 NAS PEÇAS 14 E 15, COM SUPORTE ANGULAR (G+J), EM SEGUIDA, PARAFUSE OS PAINÉIS 11, 12 E 13 COM SUPORTE ANGULAR (G+J) E CHAPA UNIÃO (F+J), CONFORME DESENHO ABAIXO.

STEP 07 THEN ATTACH THE SLATTED PANELS (21) TO PARTS 14 AND 15, WITH CORNER JOINTS (G+J). ATTACH PANELS 11, 12, AND 13 WITH CORNER JOINTS (G+J), AND 4-HOLE CONNECTION PLATES (F+J), ACCORDING TO THE DRAWINGS BELOW.

PASO 07 FIJE LOS PANELES ALISTONADOS (21) A LAS PARTES 14 Y 15 CON SOPORTES ANGULARES (G+J). DESPUÉS FIJE LOS PANELES 11, 12 Y 13 CON SOPORTES ANGULARES (G+J) Y PLACAS DE UNIÓN (F+J), SEGÚN LOS DIBUJOS ABAJO.

F = 10

G = 13

J = 40

P = 52

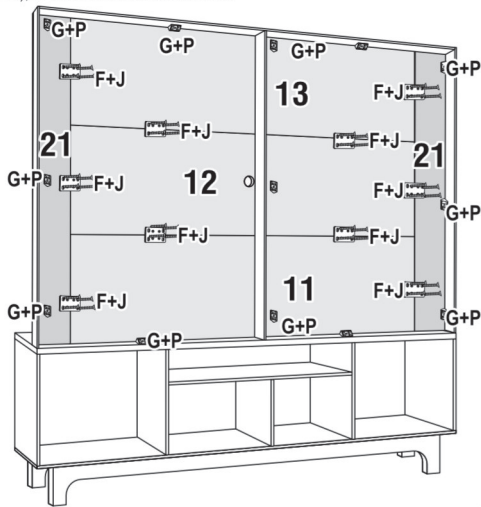

VISTA TRASEIRA
BACK VIEW
VISTA TRASERA

PASSO 08 PARAFUSE A PEÇA 20 NA PEÇA 13 COM PARAFUSO 7x60 (O).

STEP 08 FASTEN PART 20 TO PART 13 WITH 7x60 SCREWS (O).

PASO 08 FIJE LA PARTE 20 A LA PARTE 13 CON TORNILLOS 7x60 (O).

O = 2

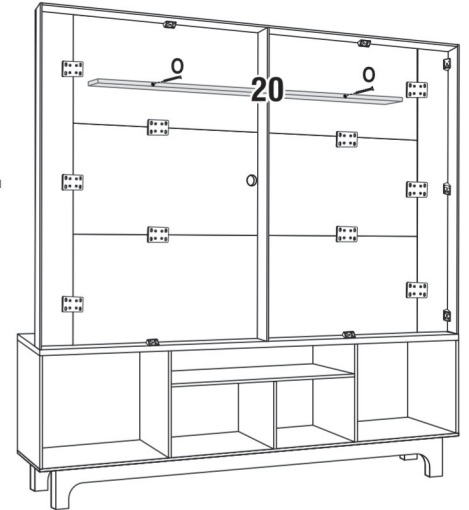

VISTA TRASEIRA
BACK VIEW
VISTA TRASERA

PASSO 09 PREGUE AS COSTAS COM PREGO 8x8 (U) E FIXADOR METÁLICO (I+U).

STEP 09 NAIL THE BACK WITH 8x8 NAILS (U) AND METAL FIXING PLATES (I+U).

PASO 09 CLAVE LA TRASERA CON CLAVOS 8x8 (U) Y GRAPAS METÁLICAS (I+U).

I = 12

U = 45

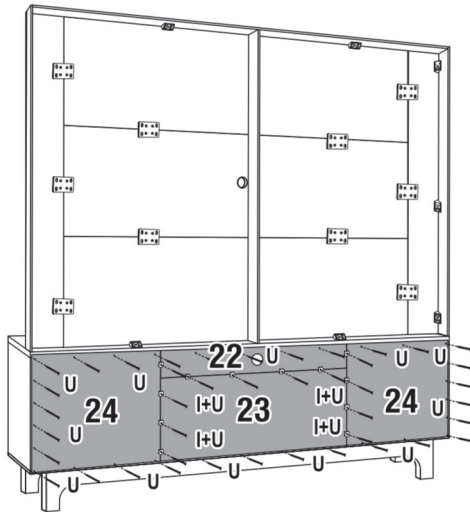

VISTA TRASEIRA
BACK VIEW
VISTA TRASERA

PASSO 10 MONTE AS PORTAS COM AS RESPECTIVAS FERRAGENS.

STEP 10 ASSEMBLE AND ATTACH THE DOORS WITH THEIR HARDWARE.

PASO 10 ARME E INSTALE LAS PUERTAS CON SUS HERRAJES.

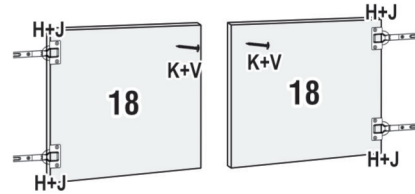

VISTA TRASEIRA
BACK VIEW
VISTA TRASERA

H = 4

J = 8

K = 2

V = 2

PASSO 11 INSTALE AS PORTAS COM AS RESPECTIVAS FERRAGENS.

STEP 11 ATTACH THE DOORS WITH THEIR HARDWARE.

PASO 11 INSTALE LAS PUERTAS CON SUS HERRAJES.

D = 4

J = 8

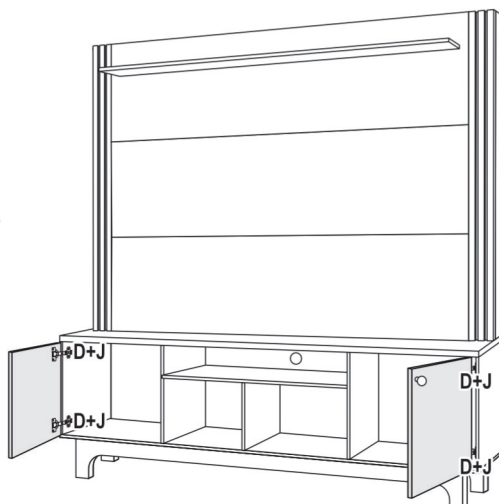

PASSO 12 INSTALE OS SUPORTE TV E COLOQUE O PASSA-FIO.

STEP 12 FASTEN THE TV RACKS AND INSTALL THE CABLE GROMMET.

PASO 12 INSTALE LOS SOPORTES DE TV Y PONGA EL PASACABLES.

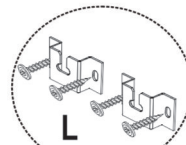

SIGA AS ORIENTAÇÕES QUE SE ENCONTRAM DENTRO DO KIT DO SUPORTE. FOLLOW THE INSTRUCTIONS THAT ARE INSIDE THE TV RACK KIT. SIGA LAS INSTRUCCIONES QUE SE ENCUENTRAN EN EL KIT DEL SOPORTE DE TV.

AO FIXAR O SUPORTE NA TV, PARAFUSOS PODEM SOBRRAR, DEPENDENDO DO TAMANHO DA TV. WHEN FASTENING THE TV RACK, SOME SCREWS MAY BE LEFT, DEPENDING ON THE TV SIZE. AL FIJAR EL SOPORTE DE TV, ALGUNOS TORNILLOS PUEDEN SOBRRAR, DEPENDIENDO DEL TAMAÑO DE LA TV.

T = 1

L = 4

