

RP5260 - ROUPEIRO

Manual de Montagem
 Assembly Instructions
 Instrucción de Montaje

decibal

5°

C2
 02 UN

B
 02 UN

P7
 02 UN

6°

P7
 04 UN

B
 04 UN

C2
 02 UN

M1
 02 UN

7°

P7
 04 UN

B
 04 UN

C2
 02 UN

M1
 02 UN

8°

P7
 04 UN

B
 04 UN

C2
 02 UN

M1
 02 UN

RP5260 - ROUPEIRO

Manual de Montagem
 Assembly Instructions
 Instrucción de Montaje



9°

C2
 08 UN
 P12
 08 UN
 Ct1
 04 UN

10°

P7
 10 UN
 B
 10 UN

11°

P12
 24 UN
 P7
 10 UN
 B
 10 UN
 Ct1
 12 UN

12°

P1
 06 UN
 TR
 01 UN

RP5260 - ROUPEIRO

Manual de Montagem
 Assembly Instructions
 Instrucción de Montaje



13°

PF
 PF 3,5X20
04 UN

R
04 UN

P1
12 UN

Pr1
10 UN

Tr1
01 UN

Pe
10 UN

14°

Ct1
02 UN

P12
04 UN

Ct
04 UN

P1
16 UN

15°

PF
02 UN

FX
30 UN

Pr1
126 UN

RP5260 - ROUPEIRO

Manual de Montagem
 Assembly Instructions
 Instrucción de Montaje



16° 6X

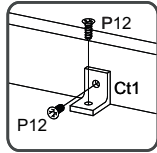
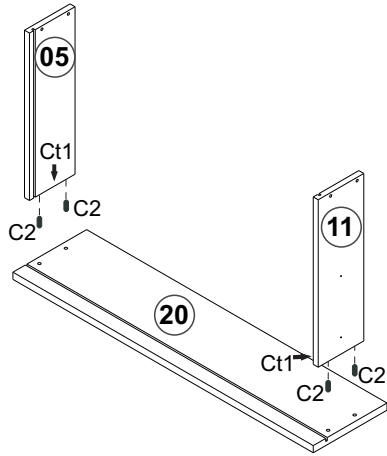

Ct1
02 UN

P12
04 UN

C2
04 UN

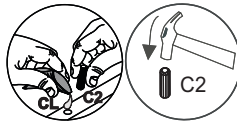

17°

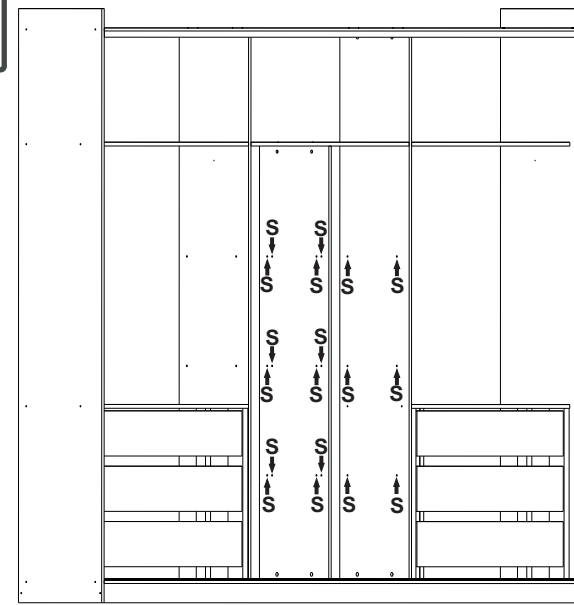

S
24 UN

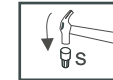

6X

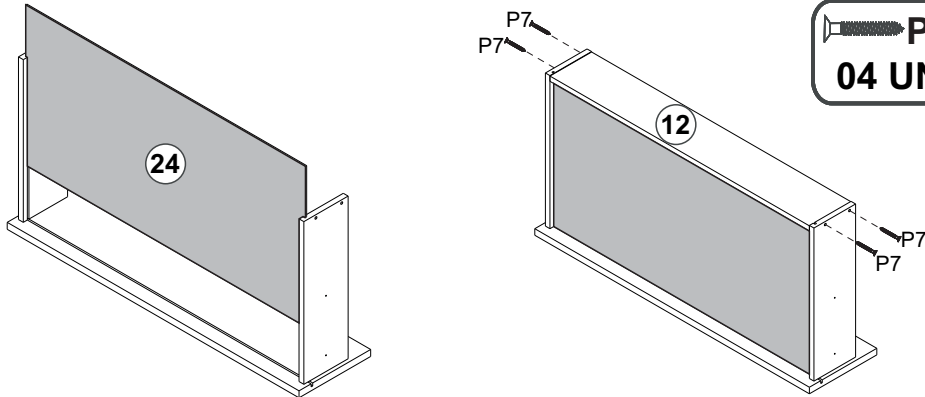

P7
04 UN

6X

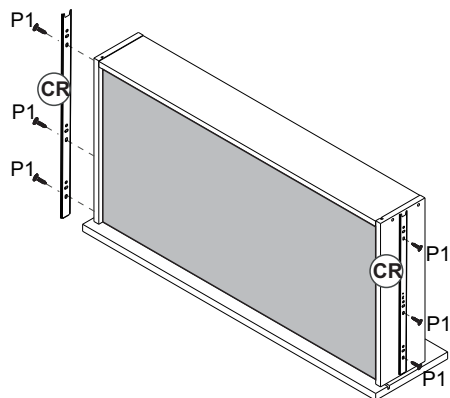

P1
06 UN

Cr
01 UN

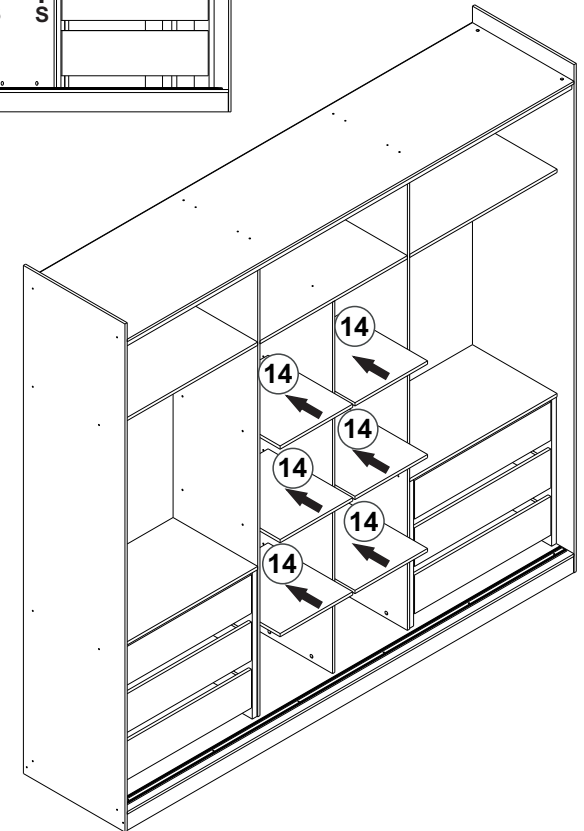
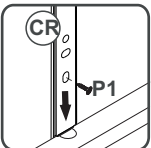
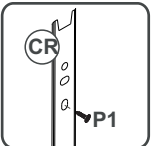

RP5260 - ROUPEIRO

Manual de Montagem
 Assembly Instructions
 Instrucción de Montaje



18°

PESO SUPORTADO/PESO SOPORTADO/ WEIGHT SUPPORTED

CB
02 UN

SC
04 UN

P1
08 UN

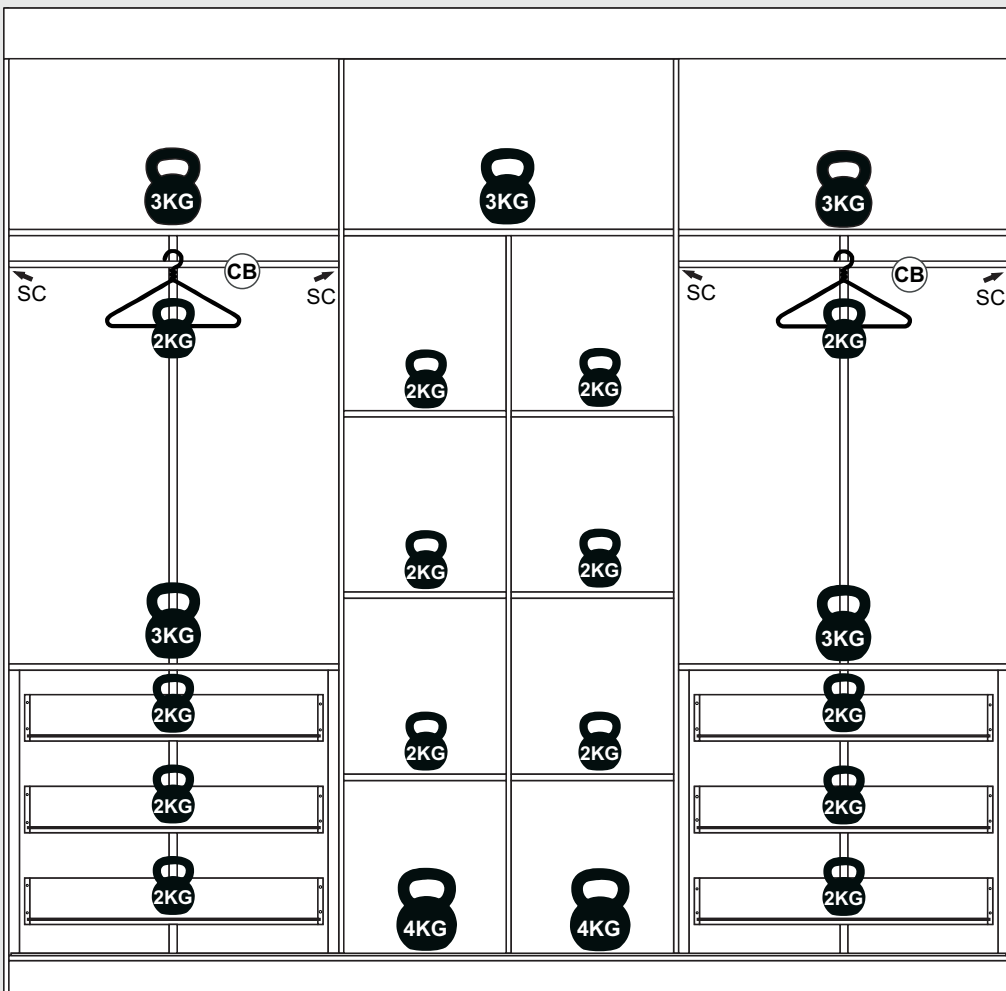
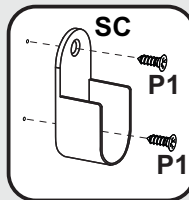

19°

PF 4X12
24 UN

R
04 UN

R
04 UN

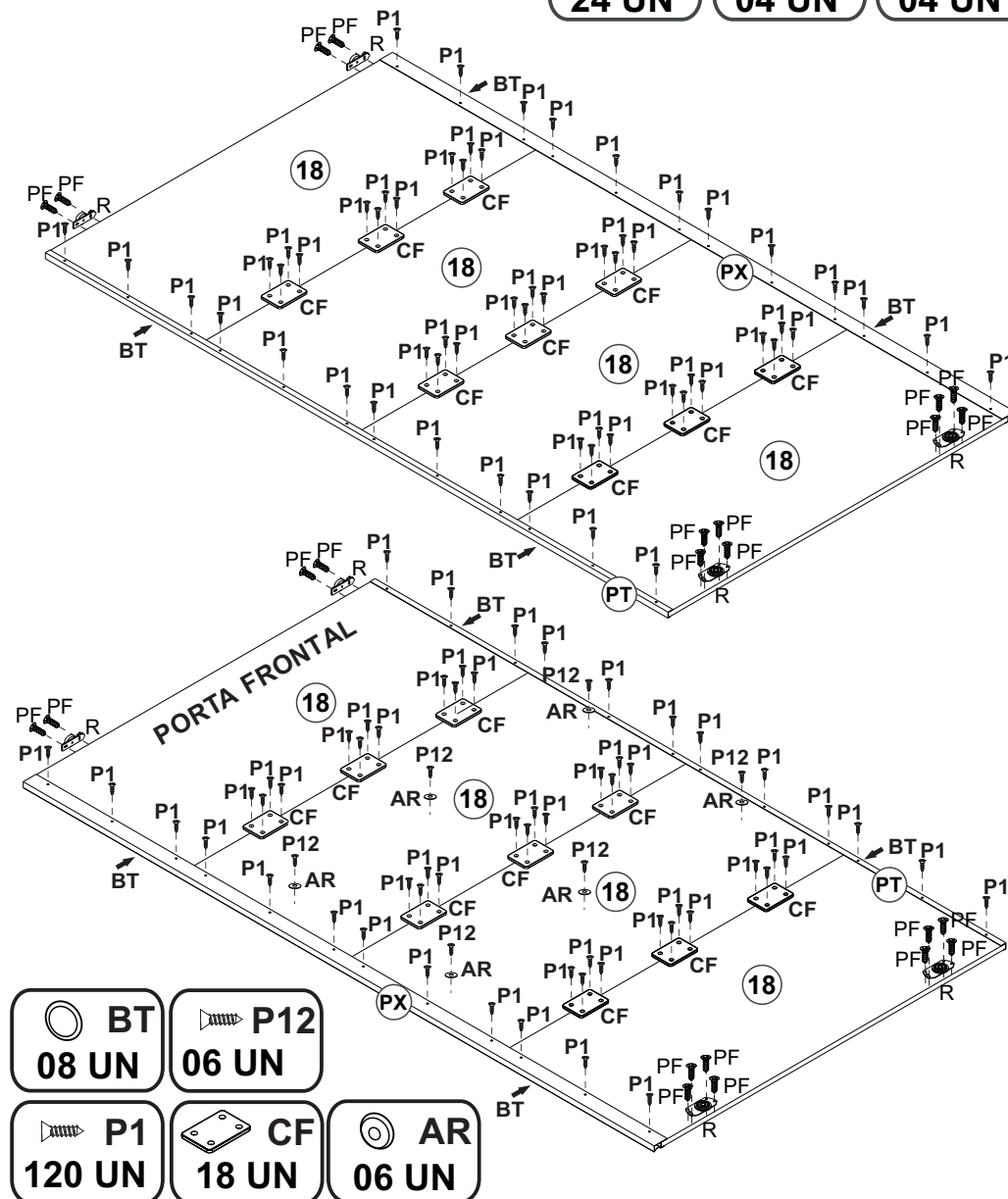

BT
08 UN

P12
06 UN

P1
120 UN

CF
18 UN

AR
06 UN

RP5260 - ROUPEIRO

Manual de Montagem
Assembly Instructions
Instrucción de Montaje

decibal®

20°

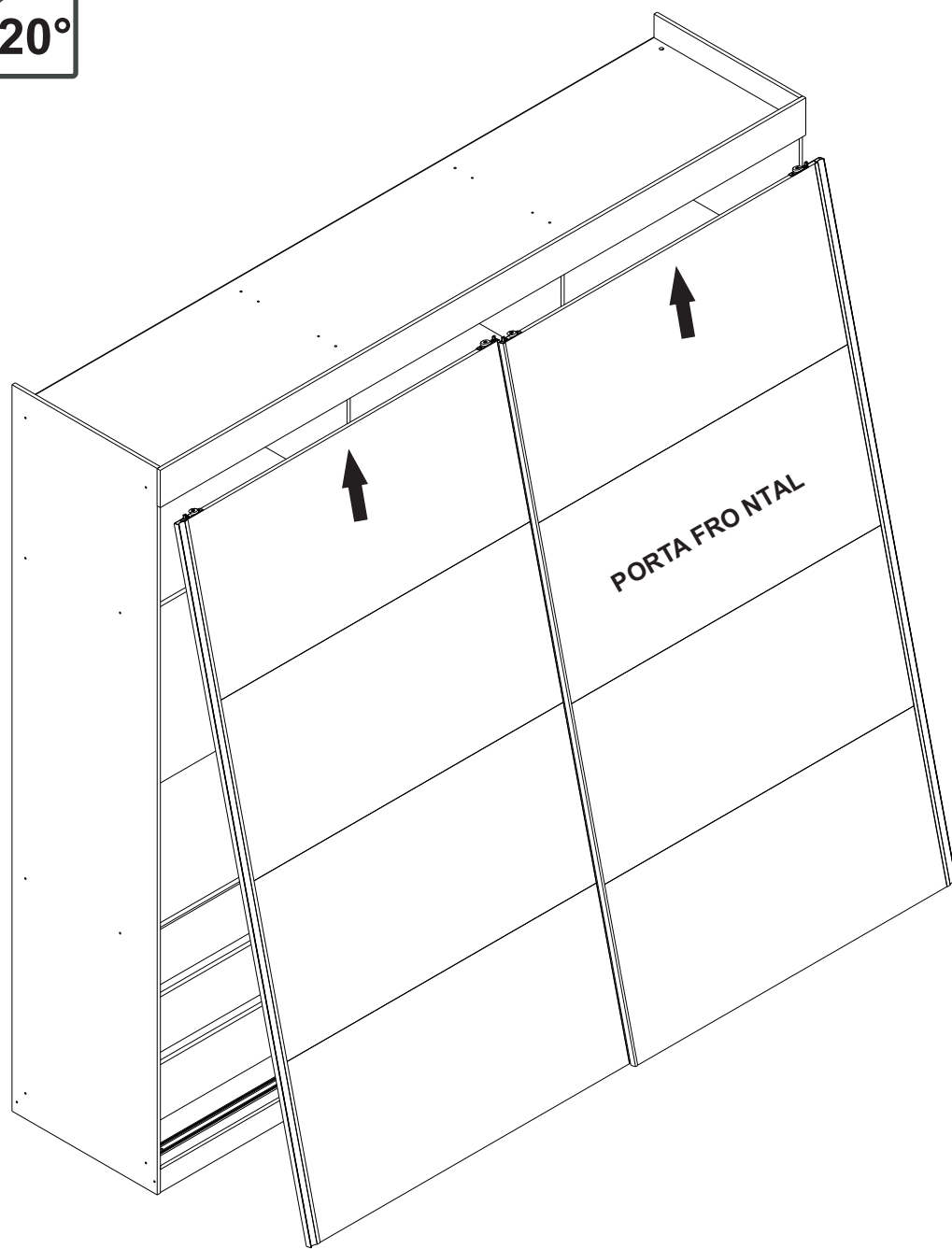

Relação de Peças/ Relación de Piezas/Parts List









N°	CÓDIGO/CODE	DESCRIÇÃO/DESCRIPCIÓN/DESCRIPTION	QTD/CANT	VOL.
1	0560560	BASE INF 2376X540X12MM	1	1
2	0560568	RODAFORRO 2401X120X12MM	1	1
3	0560566	RODAPÉ FRT/ZÓCALO/BASEBOARD 2376X76X12MM	1	1
4	0560567	RODAPÉ TRS/ZÓCALO/BASEBOARD 2376X76X12MM	1	1
5	0560576	LATERAL DIR GAV/LATERAL/SIDE 350X110X12MM	6	1
6	0560561	LATERAL DIR/LATERAL/SIDE 2340X540X12MM	1	1
7	0560562	LATERAL ESQ/LATERAL/SIDE 2340X540X15MM	1	1
8	0560563	BASE SUP 2376X540X12MM	1	1
9	0560564	DIVISÃO DIR/DIVIDER 2164X450X12MM	1	2
10	0560571	DIVISÃO CENTRAL/DIVIDER 1711X450X12MM	1	2
11	0560577	LATERAL ESQ GAV/LATERAL/SIDE 350X110X12MM	6	2
12	0560578	BATENTE/REVÉS CAJÓN/DRAWER BACK 685X110X12MM	6	2
13	0560579	RODAPÉ CENTRAL/ZÓCALO/BASEBOARD 500X76X12MM	2	2
14	0560572	PRAT MENOR/ESTAMTE/SHELF 386X450X15MM	6	2
15	0560582	COSTA/REVÉS/BACK 797X455X2,8MM	3	2
16	0561061	COSTA/REVÉS/BACK 1730X397X2,8MM	6	2
17	0560565	DIV ESQ/DIVIDER 2164X450X12MM	1	2
18	0560580	PORTA/PUERTA/DOOR 535X1168X15MM	8	3
19	0560569	PRATELEIRA MAIOR/ESTAMTE/SHELF 784X450X15MM	4	4
20	0560575	FRENTE GAVETA/FRENTE CÁJON/DRAWER 725X178X15MM	6	4
21	0560573	PILASTRA AFAST FRT/PILASTRE/PILLAR 678X96X25MM	4	4
22	0560574	PILASTRA AFAST TRS/PILASTRE/PILLAR 678X60X25MM	4	4
23	0560570	PRATELEIRA CENTRAL/ESTAMTE/SHELF 784X450X15MM	1	4
24	0560581	FUNDO GAVETA/FONDO CÁJON/DRAWER BACK 695X345X2,8MM	6	4

RP5260 - ROUPEIRO









Manual de Montagem
Assembly Instructions
Instrucción de Montaje

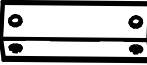

Escala (1:1)

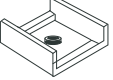
LEGENDA	DESCRIÇÃO/DESCRIPCIÓN/DESCRIPTION	CÓDIGO	QUANT.
P1	 PARAFUSO/TORNILLO/SCREW 3,5X12	01328	246
P6	 PARAFUSO/TORNILLO/SCREW 4X35	02032	24
P7	 PARAFUSO/TORNILLO/SCREW 4X45	01318	54
P12	 PARAFUSO/TORNILLO/SCREW 3,5X13	09927	66
Pr1	 PREGO/CLAVO/NAIL 10X10	01330	220
M1	 PARAFUSO/TORNILLO/SCREW MINIFIX TAMBOR/BOLT MINIFIX (HASTE SIMPLES)	06999	14
B	 BUCHA/BUJE/BUCHING	02734	30
C2	 CAVILHA/TARUGO/DOWEL 6X30 MM	01211	50

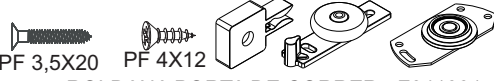
Escala (N/A)

LEGENDA	DESCRIÇÃO/DESCRIPCIÓN/DESCRIPTION	CÓDIGO	QUANT.
CL	 COLA/PEGAMENTO/GLUE	01213	02
ET	 ETIQUETA LOGO DECIBAL/LABEL DECIBAL	01312	01
Ct1	 CANTONEIRA/PIEZA L/SHEET	03077	30
CT	 CANTONEIRA/PIEZA L/METAL SHEET 80X18MM	10389	04
SC	 SUPORTE CABIDEIRO SOPORTE PERCHERO/SUPPORT TO HANGER SUPPORT	01532	04
PE	 PÉ/PATA/FOOT	01367	10
AD	 ADESIVO/ADHESIVO/ADHESIVE	15MM	20
R	 PF 3,5X20 PF 4X12 ROLDANA PORTA DE CORRER - F941031	12466	02
FX	 FIXADOR COSTA/FIJADOR FONDO/FIXER COAST	01331	95
CR	 CORREDICA/CORREDERA/METALLIC SLIDE LARG	02641	06

Medida em mm





RP5260 - ROUPEIRO

Manual de Montagem
Assembly Instructions
Instrucción de Montaje

decibal®

RP5260/E

LEGENDA	DESCRIÇÃO/DESCRIPCIÓN/DESCRIPTION	CÓDIGO	QUANT.
SE	 SUPORTE ESP/ APOYOSUPPORT	01371	16
P13	 PARAFUSO/TORNILLO/SCREW 3,5X16	10224	16
E	 ESPELHO/ESPEJO/MIRROR 1150X500X3MM	12618	04

Ferramente necessárias
Necessary tools
Herramientas necesarias



ATENÇÃO!!!! montadores e consumidores

* Ajustar o torque da parafusadeira para não danificar as peças escareando o parafuso *

ATENCIÓN!!!! montadores e consumidores

* Ajuste el torque del destornillador para no dañar las piezas avallanando el tornillo *

ATTENTION!!!! assemblers and consumers

* Adjust the torque of the screwdriver so as not to damage the parts by countersinking the screw *

www.decibal.com.br

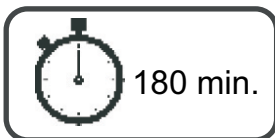

180 min.



2 montador
2 ajustador
2 Fitter

ATENÇÃO!!!! montadores e consumidores

* Para limpar o móveis utilize somente um pano úmido (umedecido em água pura ou água com sabão neutro). Depois, passe um pano seco. Evite a umidade excessiva.

* Evite usar álcool, água sanitária, detergente e outros produtos químicos, mesmo diluídos em água. Não utilize produtos abrasivos de nenhuma espécie

ATENCIÓN!!!! montadores e consumidores

* Para limpiar el mueble utilice solamente un paño húmedo (humedecido con agua limpia o con un jabón suave). A continuación, utilice un paño seco. Evite el exceso de humedad.







* Evite uso de alcohol, hipoclorídrico solución basada, detergente y otros productos químicos, mismo diluídos en agua. No utilice productos abrasivos de ningún tipo.

ATTENTION!!!! assemblers and consumers

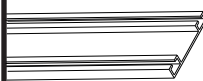
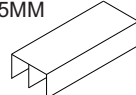
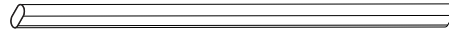
*To clean the furniture, use only a damp cloth (humidify it only in pure water ou water and neutral soap).After, use a dry cloth.Avoid excessive humidity.
*Avoid using alcohol, bleach, detergent and other chemical products, even diluted in water. Do not use any kind of abrasive cleaning agents to clean the furniture.

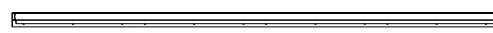
The use of such products may jeopardize the ?nal characteristics of the furniture.

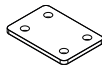
Escala (N/A)

LEGENDA	DESCRIÇÃO/DESCRIPCIÓN/DESCRIPTION	CÓDIGO	QUANT.
TR	 TRILHO/TRILLO/RAIL 2365MM	12557	01
TR1	TRILHO SOBREPOR (SUPEIOR) 2365MM MOV3013 NATURAL (DUPLO) 	12558	01
CB	 CABIDEIRO/ROLIZO PERCHA/ROD FOR HANGERS 770MM	12034	02
PT	 PERFIL TESTEIRA 2140MM (MOV2013)	12414	02
PX	 PUX ALUM GOLA 2140MM(MOV4062)	12413	02
PF	 PERFIL/PROFILE/PERFIL 1730 MM	12554	02
S	 SUPORTE /SOPORTE /SUPPORT	01368	24
CF	 CHAPA FIXAÇÃO/FIJACIÓN DE LA PLACA/ PLATE FIXATION	12688	18
BT	 BATENTE/BATIENTE DE SILICONA/SILICONE STOP 8MM	02921	08
AR	 ARUELA SILICONE/ARANDELA/WASHER 14X3mm	11810	06