

Roupeiro 06 Portas / Armario de 06 Puertas / 06 Door Wardrobe

- B368-127 Nature/Off White
- B368-198 Jequitibá Brilho

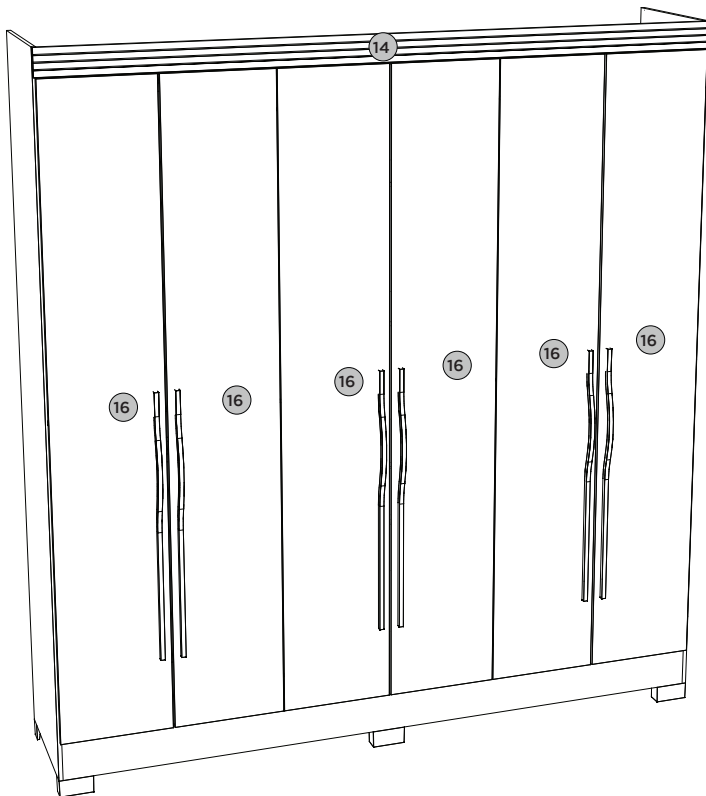

Pesos máximos recomendados com carga distribuída
Peso máximo recomendado con la carga distribuida
Recommended maximum weights with evenly distributed.

Requisitos para montagem
Requisitos para la montaje
Assembly Requirements

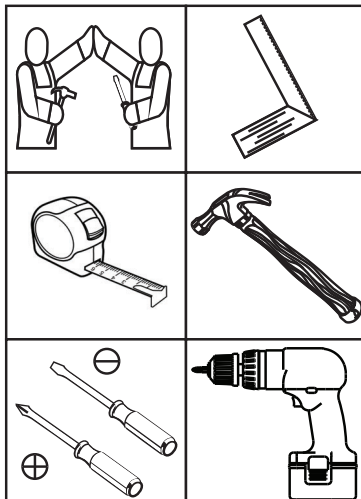

Imagens meramente ilustrativas,
não acompanha o produto.
Imágenes ilustrativas, no incluidas
con el producto.
Illustrative images, not included
with the product.

AVISO

Para limpeza de seu móvel, use uma flanela seca ou umedecida, e não utilize produtos químicos que possam danificar seu produto.

SISTEMA DE MONTAGEM

O sistema de montagem dos produtos, funciona de acordo com a ordem crescente dos números indicados no desenho. Ex: 01, 02, 03, 04... até a conclusão da montagem.

ASSISTÊNCIA TÉCNICA

Para solicitação de Assistência Técnica você consumidor deverá entrar em contato com o Lojista o qual você realizou a compra deste produto e solicitar a assistência técnica das peças avariadas. A garantia abrange todas as peças, partes e componentes que eventualmente venham apresentar defeito de fabricação no prazo de 03 (três) meses, contando a partir da entrega do produto ao consumidor, mediante nota fiscal de compra. Se houver qualquer alteração na estrutura do produto ou ocorrer defeito por negligência do montador/consumidor em relação a instrução de montagem e manuseio, não será fornecido assistência técnica gratuita.

ADVERTENCIA

Para limpeza de su móvil, use una flanela seca o húmeda, y no utilice productos químicos que puedan dañar su producto.

SISTEMA DE MONTAJE

El sistema de montaje de los productos funciona de acuerdo con el orden creciente de los números indicados en el dibujo. Ej.: 01, 02, 03, 04... hasta la conclusión del montaje.

ASISTENCIA TÉCNICA

Para solicitar Asistencia Técnica, el consumidor debe comunicarse con el Comercio que usted realizó la compra de este producto y solicita asistencia técnica para las partes dañadas. La garantía cubre todas las partes, piezas y componentes que eventualmente puedan presentar defecto de fabricación en el plazo de 03 (tres) meses, contados a partir de la entrega del producto al consumidor, mediante factura de compra. Si se produce algún cambio en la estructura del producto o se produce un defecto por negligencia del montador/consumidor en relación con las instrucciones de montaje y manipulación, no se prestará asistencia técnica gratuita.

NOTICE

To clean your furniture, use a dry or wet cloth, and do not use chemicals that may damage your product.

ASSEMBLY SYSTEM

The products' assembly system works according to the increasing order of the indicated numbers. For example: 01, 02, 03, 04 ... to the end of the assembly.

TECHNICAL ASSISTANCE

To request Technical Assistance, the consumer must contact the retailer from whom you purchased this product and request technical assistance for the damaged parts. The warranty covers all parts, parts and components that may eventually present a manufacturing defect within a period of 03 (three) months, counting from the delivery of the product to the consumer, by means of a purchase invoice. If there is any change in the structure of the product or defect occurs due to negligence of the assembler/consumer in relation to the assembly and handling instruction, free technical assistance will not be provided.

1

- Vista Inferior
- Vista Inferior
- Bottom view

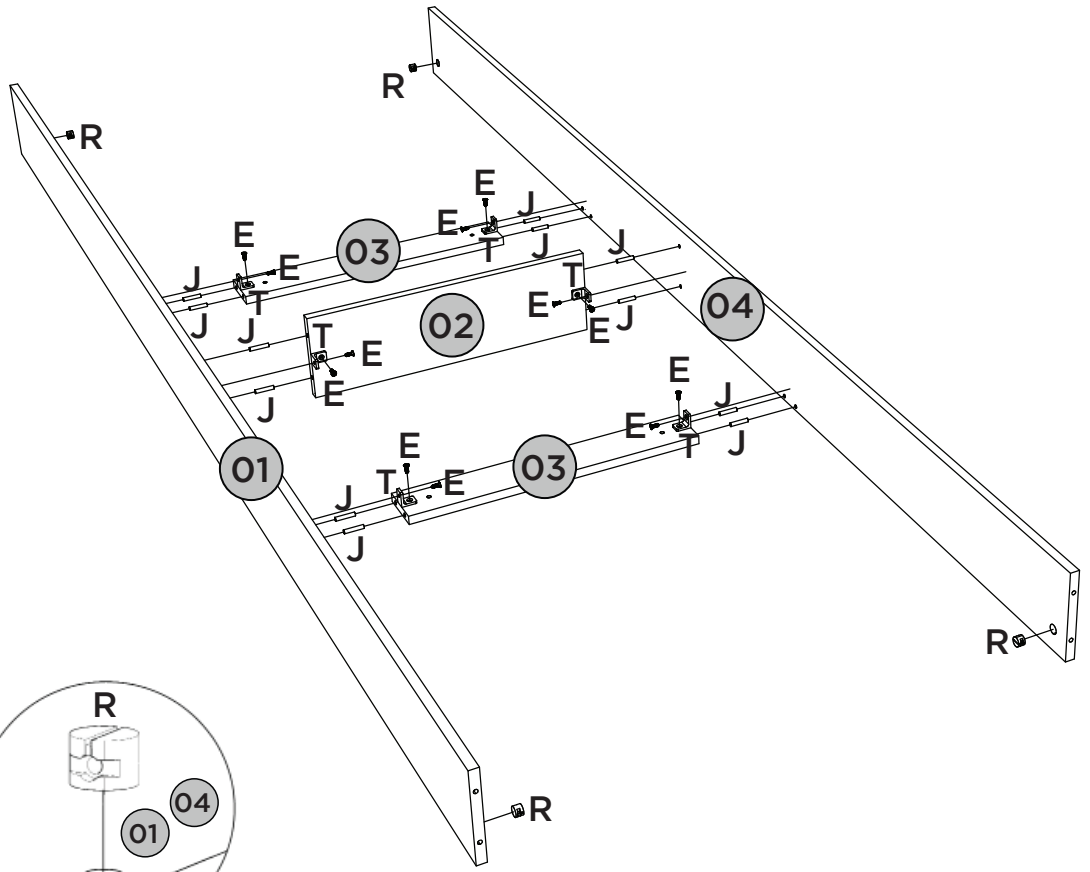

2

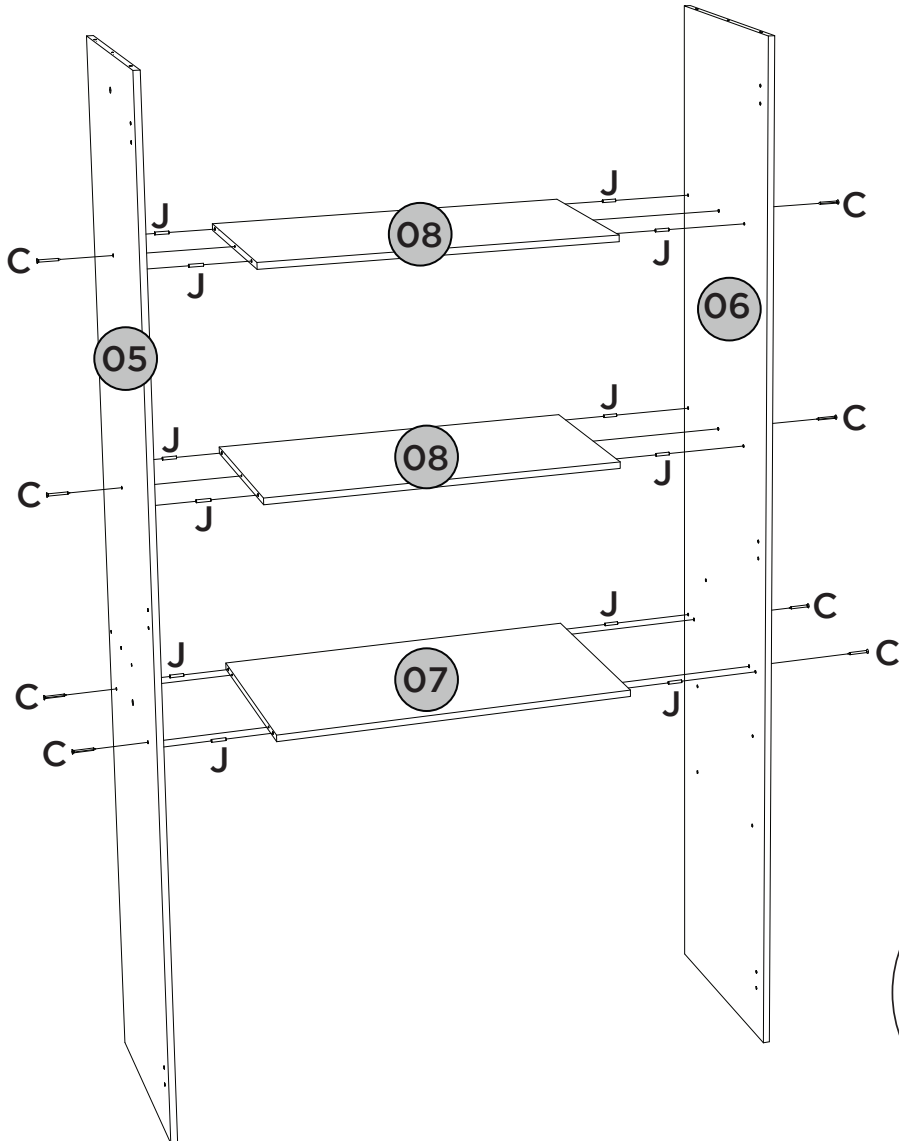

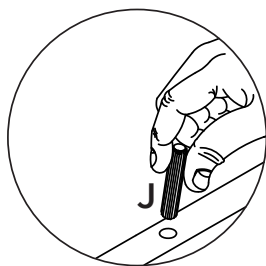
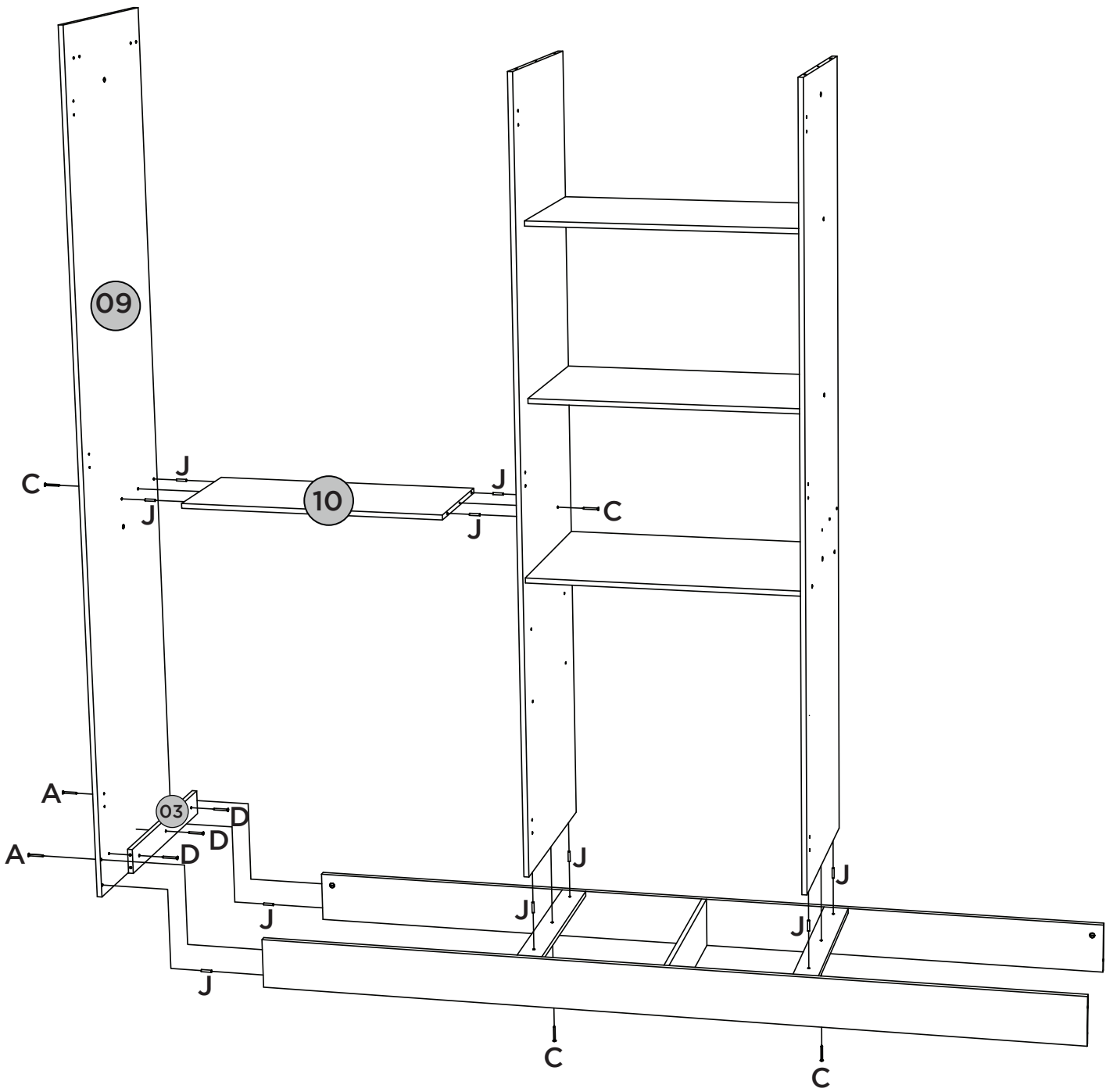

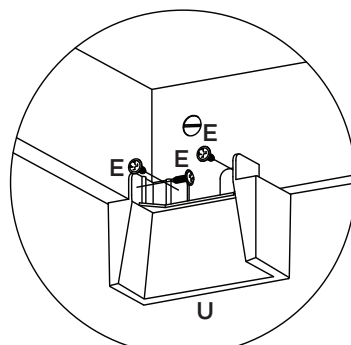
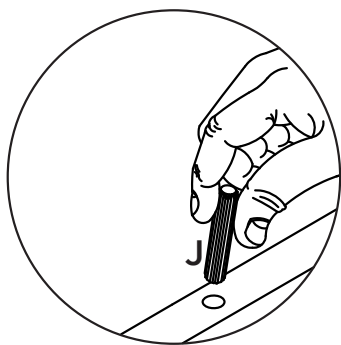
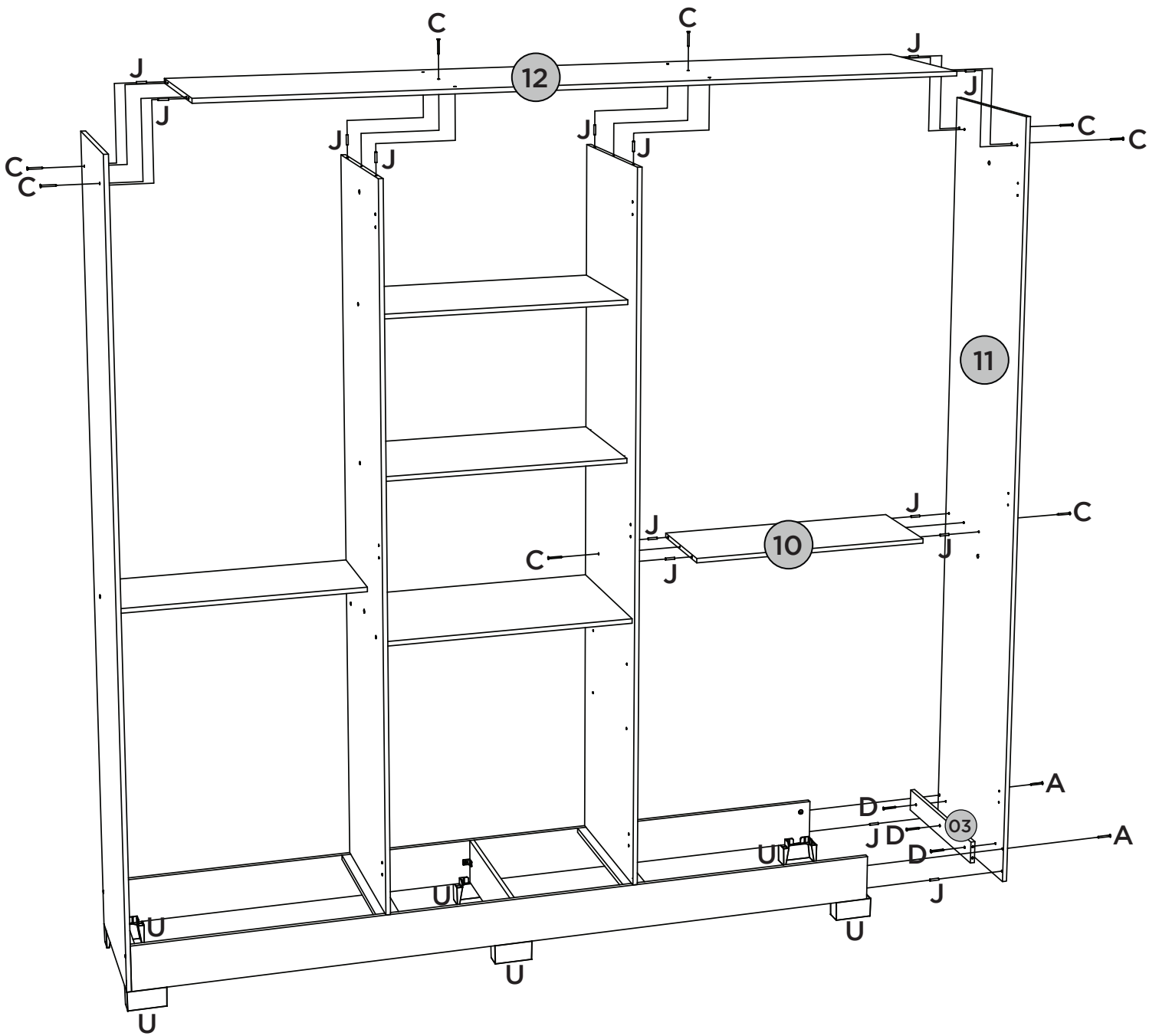

5

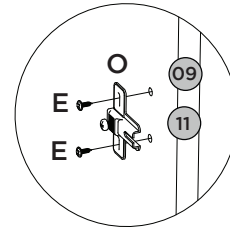
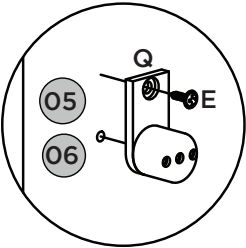
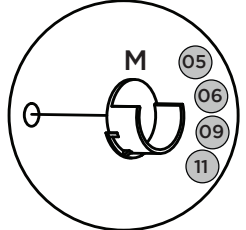
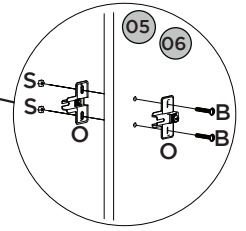
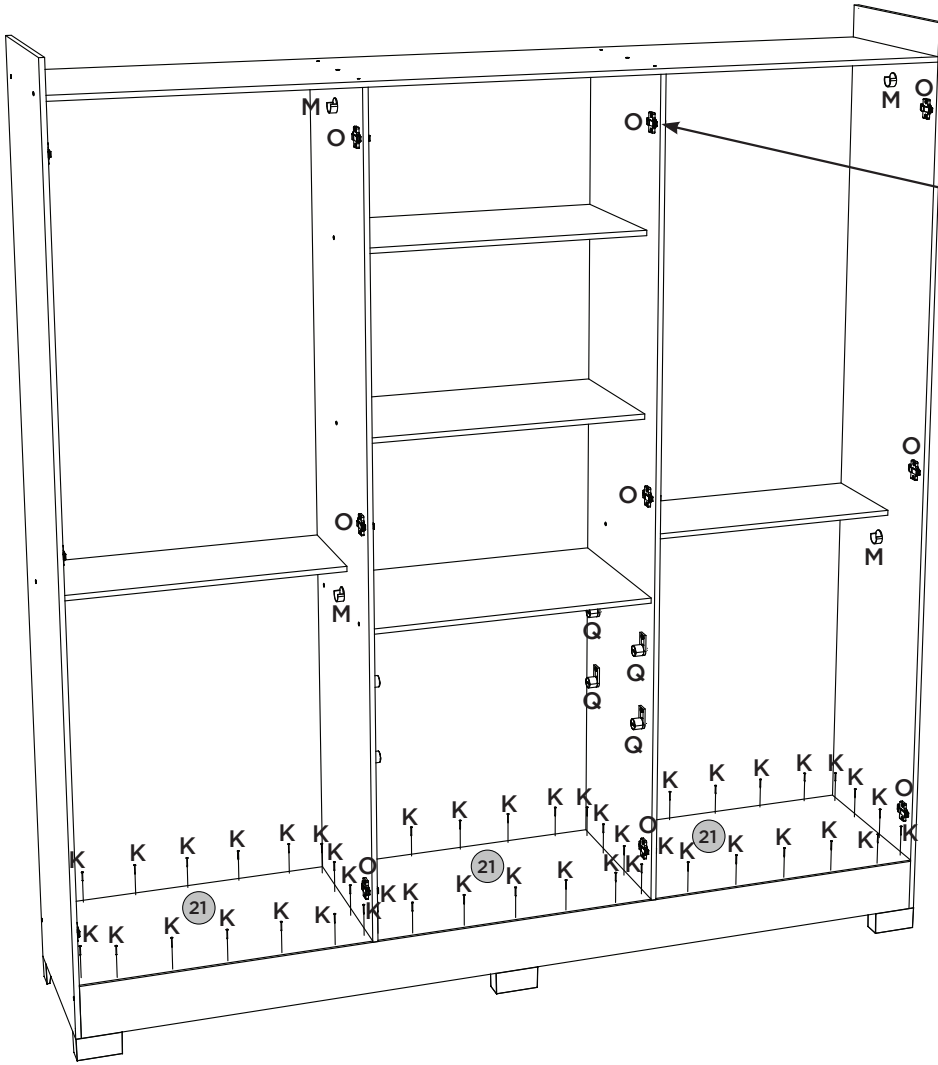

6

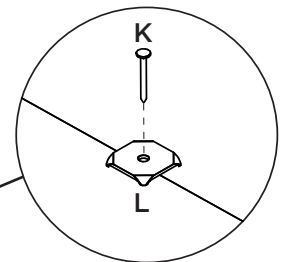
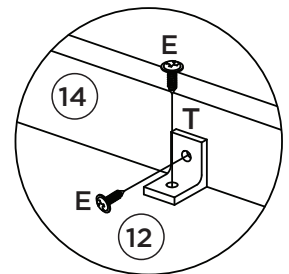
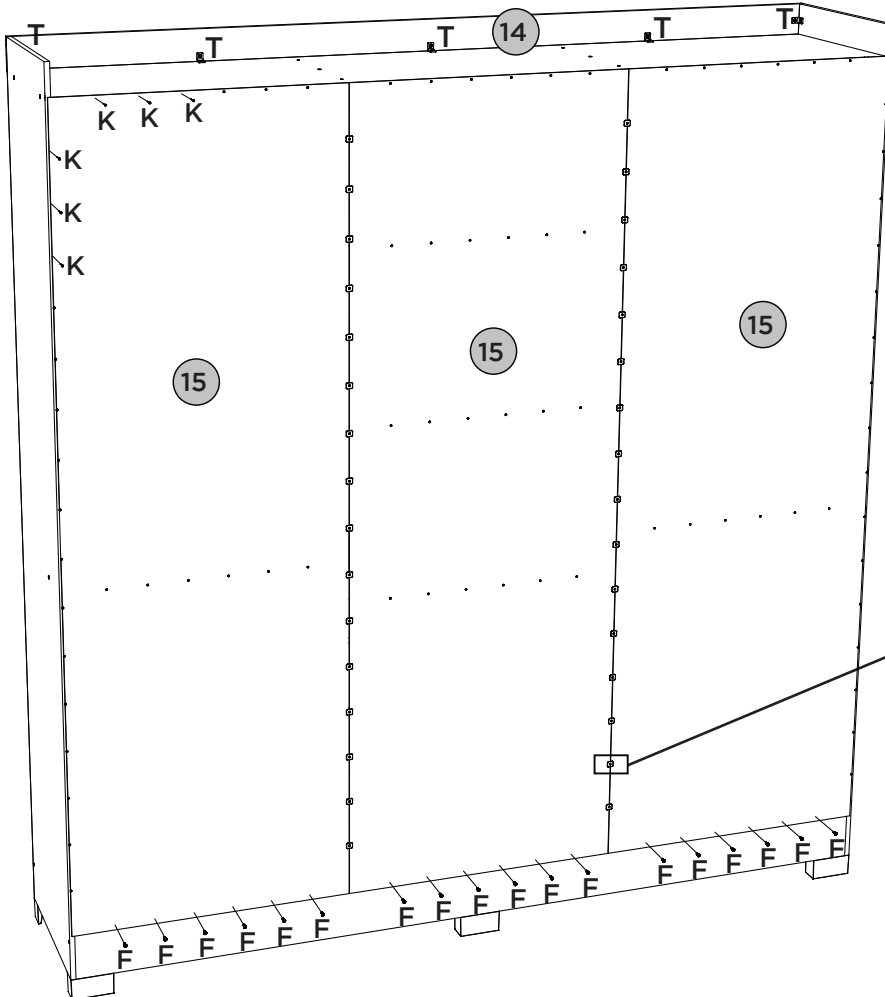

- Fixar os pregos a uma distância de 120mm de um para outro.
- Fijar las uñas a un distancia de 120 mm uno a otro.
- Fix the nails at a distance of 120mm from one to the other

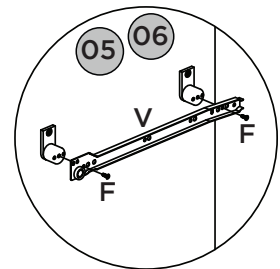
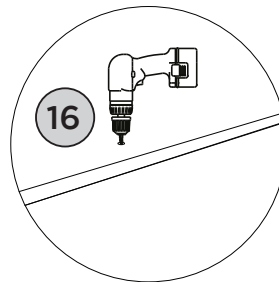
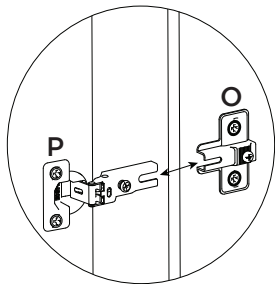
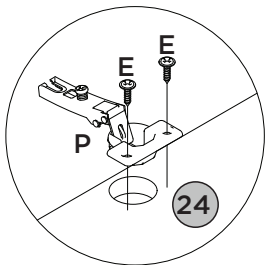
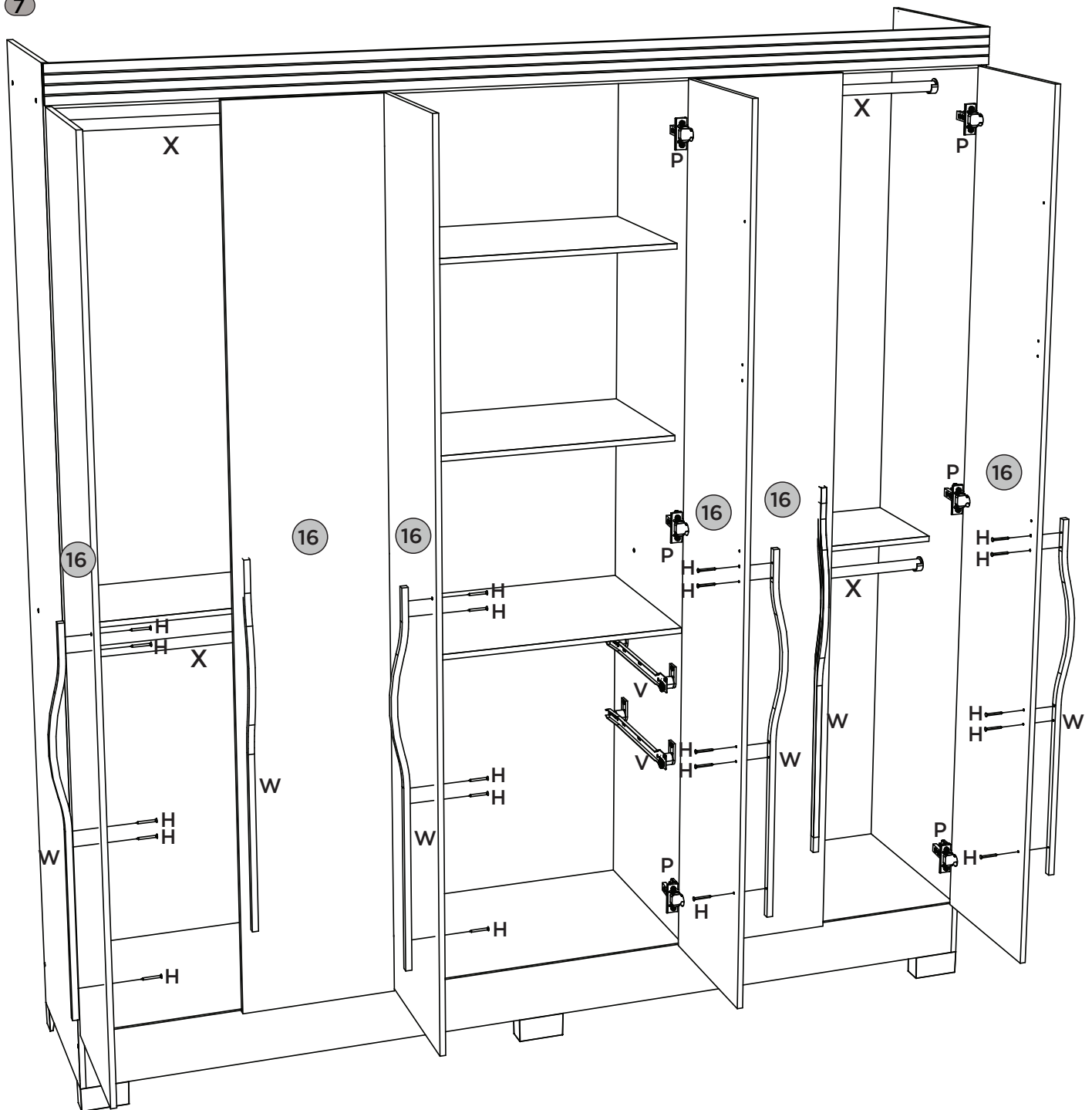

Vídeo: Instalar e regular Dobradiças

Video: Instale y ajuste las bisagras

Video: Install and adjust hinges

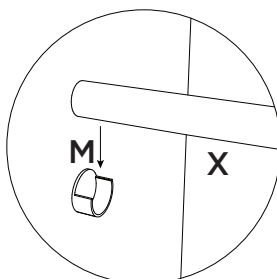

Vídeo: Dicas para instalar corredeira

Video: consejos para instalar la diapositiva

Video: Tips for installing slide

8

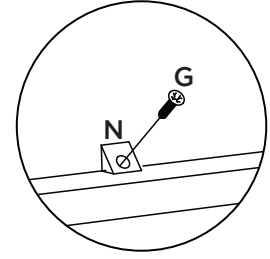
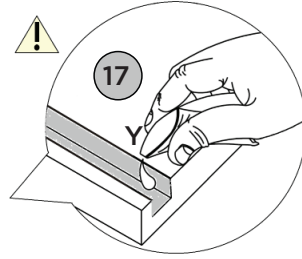
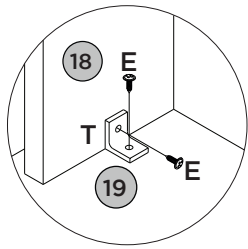
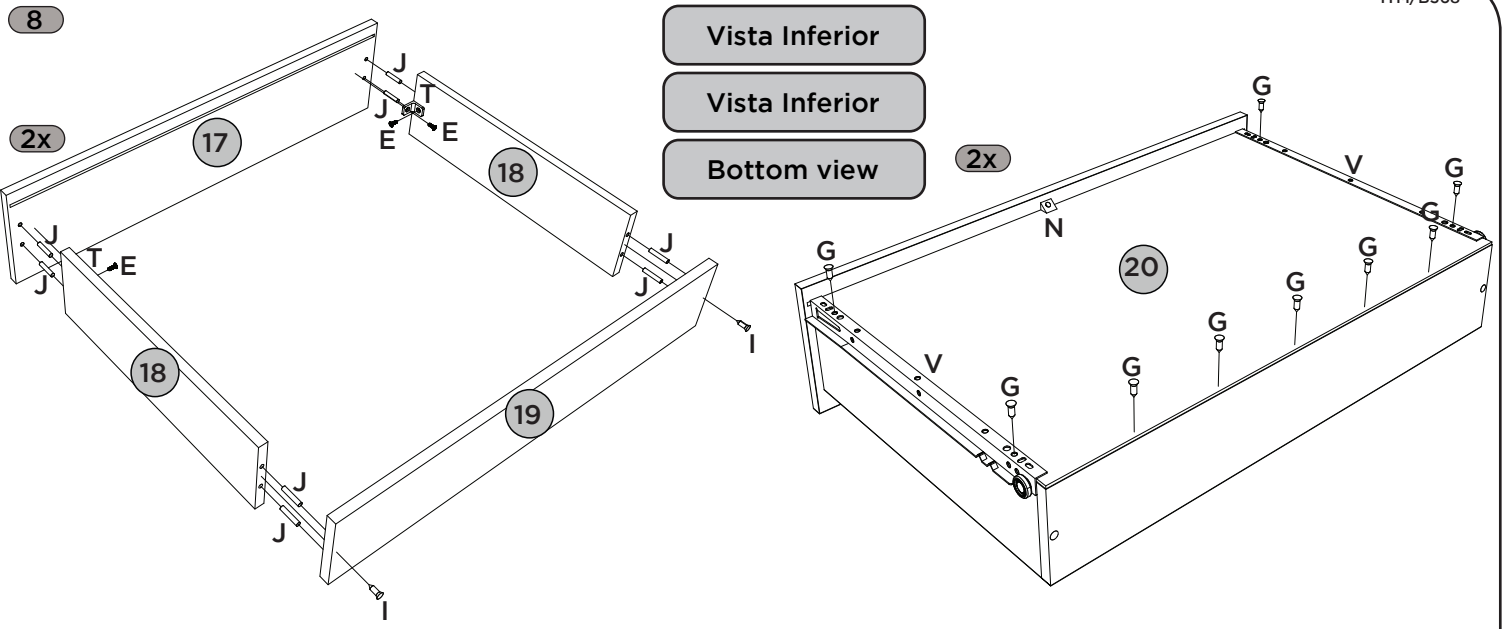



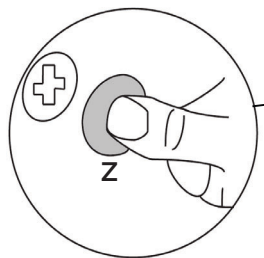
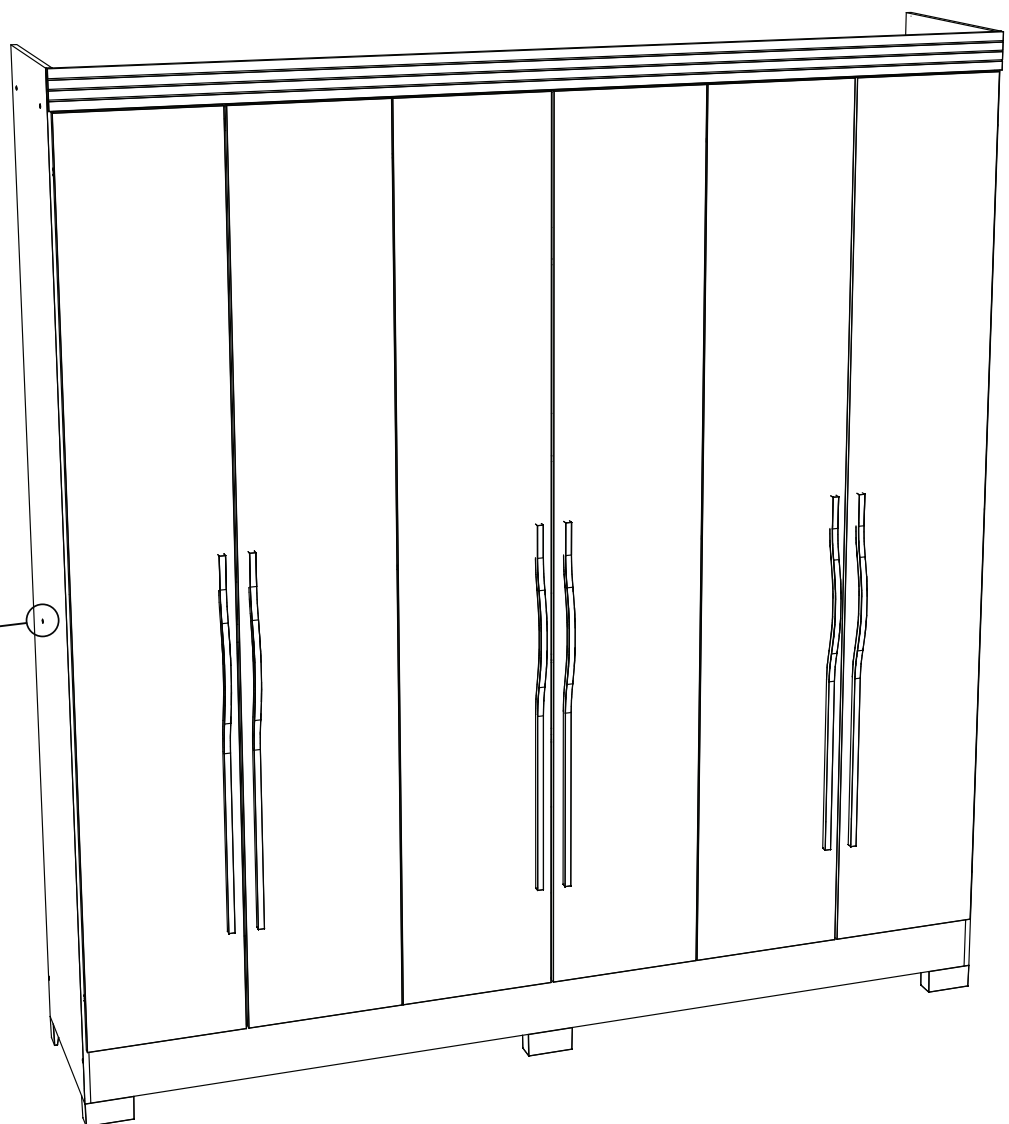









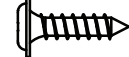

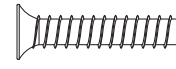

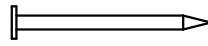

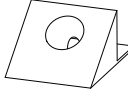
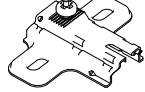
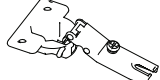
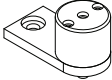

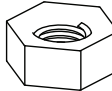
9

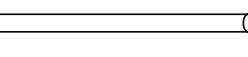

Item	Caixa Caja Box	Qtd Ctd Qty	Descrição Descripción Description	Medidas (mm) Dimensions (mm) Size (measurements) (mm)
1	1/2	01	Rodapé frontal Rodapié frontal Front footboards	1971x120x12
2	1/2	01	Travessa Rodapé Rodapié Bandeja Footboard Platter	394x120x12
3	1/2	04	Travessa Base Bandeja Base Base Platter	394x60x12
4	1/2	01	Rodapé traseiro Rodapié trasero Rear footboard	1971x120x12
5	1/2	01	Divisão esquerda División izquierda Left division	1893x420x12
6	1/2	01	Divisão direita División derecha Right division	1893x420x12
7	1/2	01	Tampo das Gavetas Cubre los cajones Drawer Top	649x400x12
8	1/2	02	Prateleira Estante Shelf	649x350x12
9	1/2	01	Lateral esquerda Lateral izquierda Left side	2100x420x12
10	1/2	02	Prateleira do calceiro Estante de Calceiro Calceiro's Shelf	649x250x12
11	1/2	01	Lateral direita Lateral derecha Right side	2100x420x12
12	1/2	01	Tampo Cubrir Cover	1971x420x12
13	1/2	03	Base 3mm Base 3mm Base 3mm	649x420x3
14	1/2	01	Chapéu Sombrero Hat	1993x80x12
15	2/2	03	Fundo Fondo Background	1916x661x3
16	2/2	06	Porta Puerta Door	1900x327x12
17	1/2	02	Frente de Gaveta Frente del Cajón Drawer Front	591x145x12
18	1/2	04	Lado de gaveta Lado del cajón Drawer side	350x100x12
19	1/2	02	Ripa de trás Listón trasero Rear batten	574x100x12
20	1/2	02	Fundo de gaveta recortado Fondo de cajón recortado Cropped drawer bottom	573x367x3

FERRAGENS | HERRAJES | HARDWARE

A  Parafuso 4,5x50mm CHT. Tornillo 4,5x50mm CHT. Screw 4,5x50mm CHT.	B  Parafuso 4,0x22mm FLA MET. Tornillo 4,0x22mm FLA MET. Screw 4,0x22mm FLA MET.	C  Parafuso 3,5x40mm CHT. Tornillo 3,5x40mm CHT. Screw 3,5x40mm CHT.	D  Parafuso 3,5x22mm CHT. Tornillo 3,5x22mm CHT. Screw 3,5x22mm CHT.	E  Parafuso 3,5x12mm FLA. Tornillo 3,5x12mm FLA. Screw 3,5x12mm FLA.
F  Parafuso 3,5x12mm CHT. Tornillo 3,5x12mm CHT. Screw 3,5x12mm CHT.	G  Parafuso 3,0x16mm CHT. Tornillo 3,0x16mm CHT. Screw 3,0x16mm CHT.	H  Parafuso 3,5x22mm CHT. Tornillo 3,5x22mm CHT. Screw 3,5x22mm CHT.	I  Prego 12x12mm Anelado Clavo 12x12mm Anillado Ringed Nails 12x12mm	J  Cavilha 5x25mm Cinta 5x25mm Dowel 5x25mm
K  Prego 10x10mm Clavo 10x10mm Nail 10x10mm	L  Fixador de fundos Fijador de fondos Bottom fixer	M  Suporte cabideiro Soporte de percha Coat hanger support	N  Cantoneira Suporte Triangular Ángulo soporte triangular Triangular Support Angle	O  Calço metal 5mm Calzado metálico 5mm 5mm metal shim
P  Dobradiça metal L2 26 mm Bisagra de metal L2 26 mm 26 mm L2 metal hinge	Q  Distanciador de corredeira Distanciadore de deslizamiento Sliding spacer	R  Porca cilíndrica Tuerca cilíndrica Cylindrical nut	S  Porca sextavada Tuerca hexagonal Hexagon nuts	T  Cantoneira plástica Cantonera plástica Plastic angle brackets
U  Pé "U" 50x40x100mm Pie "U" 50x40x100mm 50x40x100mm "U" feet	V  Corredeira metal 350mm Corredera metal 350mm Sliding metal 350mm	W  Puxador Ceará 795mm Tirador Ceará 795mm Ceará Handle 795mm	X  Cabideiro Madeira 643mm Cabezal Madera 643mm 643mm wooden hanger	Y  Sachê de cola Bolsa de pegamento Glue bag
Z  Adesivo tapa parafuso 10mm Adhesivo tapón de tornillo 10mm Bolt cover adhesive 10mm	AA  Etiqueta resinada Briz Etiqueta resinada Briz Briz resin label			