

Roupeiro 06 Portas / Armario de 06 Puertas / 06 Door Wardrobe

- B366-127 Nature/Off White
- B366-215 Nature/Preto HP

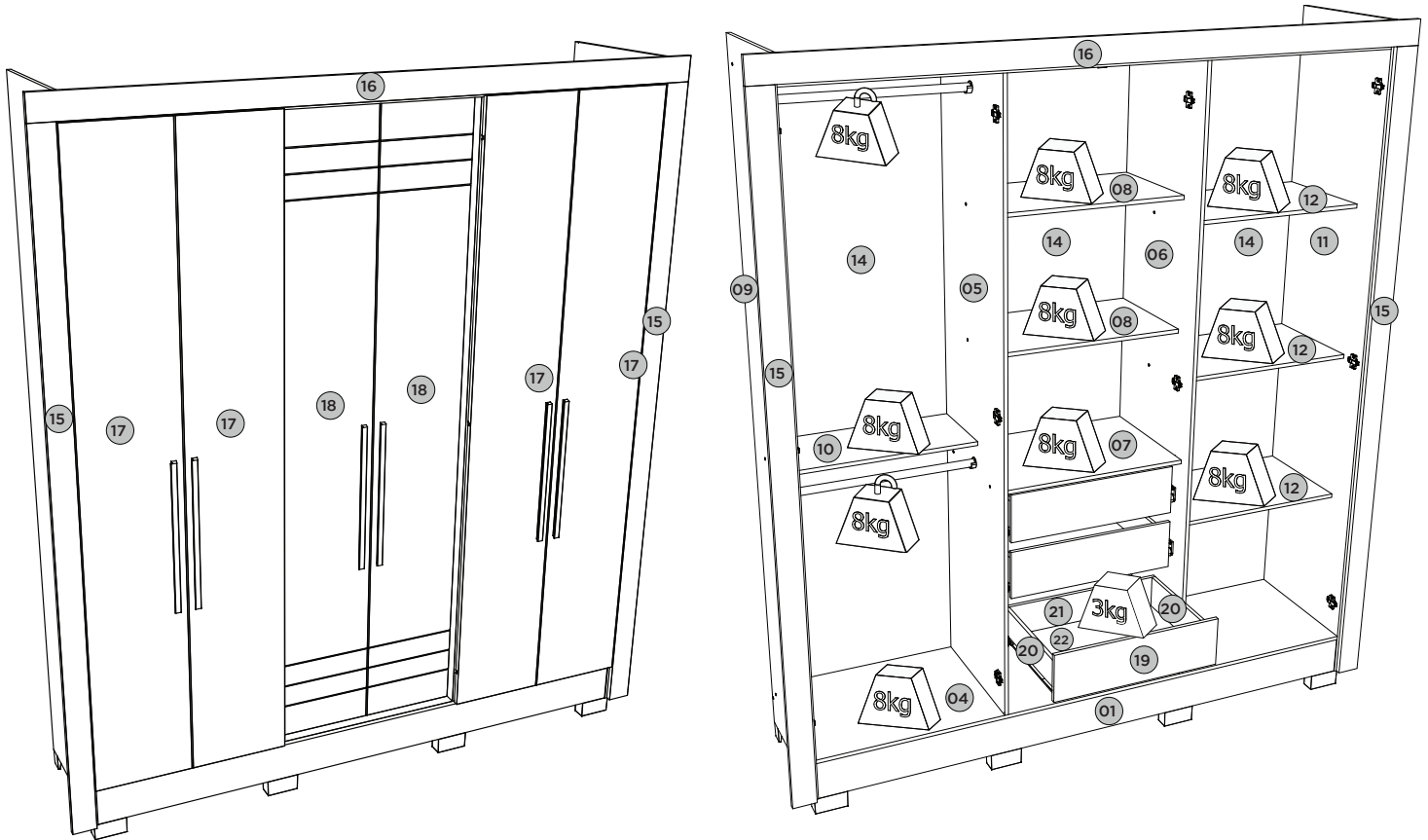

Pesos máximos recomendados com carga distribuída
Peso máximo recomendado con la carga distribuida
Recommended maximum weights with evenly distributed.

Requisitos para montagem
Requisitos para la montaje
Assembly Requirements

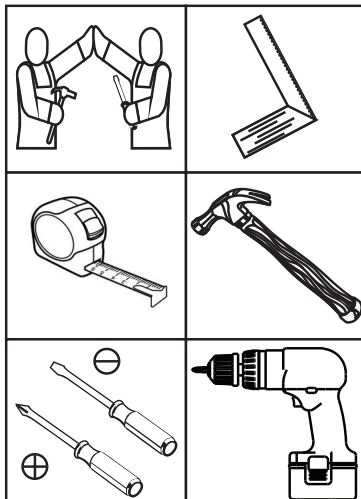

Imagens meramente ilustrativas,
não acompanha o produto.
Imágenes ilustrativas, no incluidas
con el producto.
Illustrative images, not included
with the product.

AVISO

Para limpeza de seu móvel, use uma flanela seca ou umedecida, e não utilize produtos químicos que possam danificar seu produto.

SISTEMA DE MONTAGEM

O sistema de montagem dos produtos, funciona de acordo com a ordem crescente dos números indicados no desenho. Ex: 01, 02, 03, 04... até a conclusão da montagem.

ASSISTÊNCIA TÉCNICA

Para solicitação de Assistência Técnica você consumidor deverá entrar em contato com o Lojista o qual você realizou a compra deste produto e solicitar a assistência técnica das peças avariadas. A garantia abrange todas as peças, partes e componentes que eventualmente venham apresentar defeito de fabricação no prazo de 03 (três) meses, contando a partir da entrega do produto ao consumidor, mediante nota fiscal de compra. Se houver qualquer alteração na estrutura do produto ou ocorrer defeito por negligência do montador/consumidor em relação a instrução de montagem e manuseio, não será fornecido assistência técnica gratuita.

ADVERTENCIA

Para limpeza de su móvil, use una flanela seca o húmeda, y no utilice productos químicos que puedan dañar su producto.

SISTEMA DE MONTAJE

El sistema de montaje de los productos funciona de acuerdo con el orden creciente de los números indicados en el dibujo. Ej: 01, 02, 03, 04... hasta la conclusión del montaje.

ASISTENCIA TÉCNICA

Para solicitar Asistencia Técnica, el consumidor debe comunicarse con el Comercio que usted realizó la compra de este producto y solicita asistencia técnica para las partes dañadas. La garantía cubre todas las partes, piezas y componentes que eventualmente puedan presentar defecto de fabricación en el plazo de 03 (tres) meses, contados a partir de la entrega del producto al consumidor, mediante factura de compra. Si se produce algún cambio en la estructura del producto o se produce un defecto por negligencia del montador/consumidor en relación con las instrucciones de montaje y manipulación, no se prestará asistencia técnica gratuita.

NOTICE

To clean your furniture, use a dry or wet cloth, and do not use chemicals that may damage your product.

ASSEMBLY SYSTEM

The products' assembly system works according to the increasing order of the indicated numbers. For example: 01, 02, 03, 04 ... to the end of the assembly.

TECHNICAL ASSISTANCE

To request Technical Assistance, the consumer must contact the retailer from whom you purchased this product and request technical assistance for the damaged parts. The warranty covers all parts, parts and components that may eventually present a manufacturing defect within a period of 03 (three) months, counting from the delivery of the product to the consumer, by means of a purchase invoice. If there is any change in the structure of the product or defect occurs due to negligence of the assembler/consumer in relation to the assembly and handling instruction, free technical assistance will not be provided.

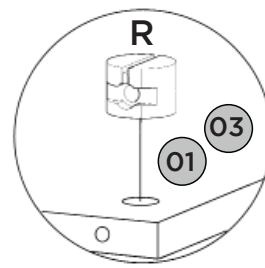
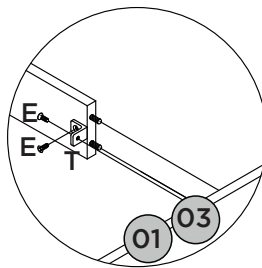
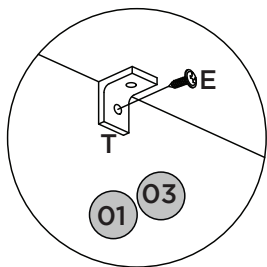
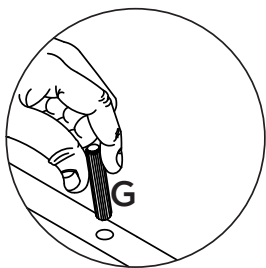
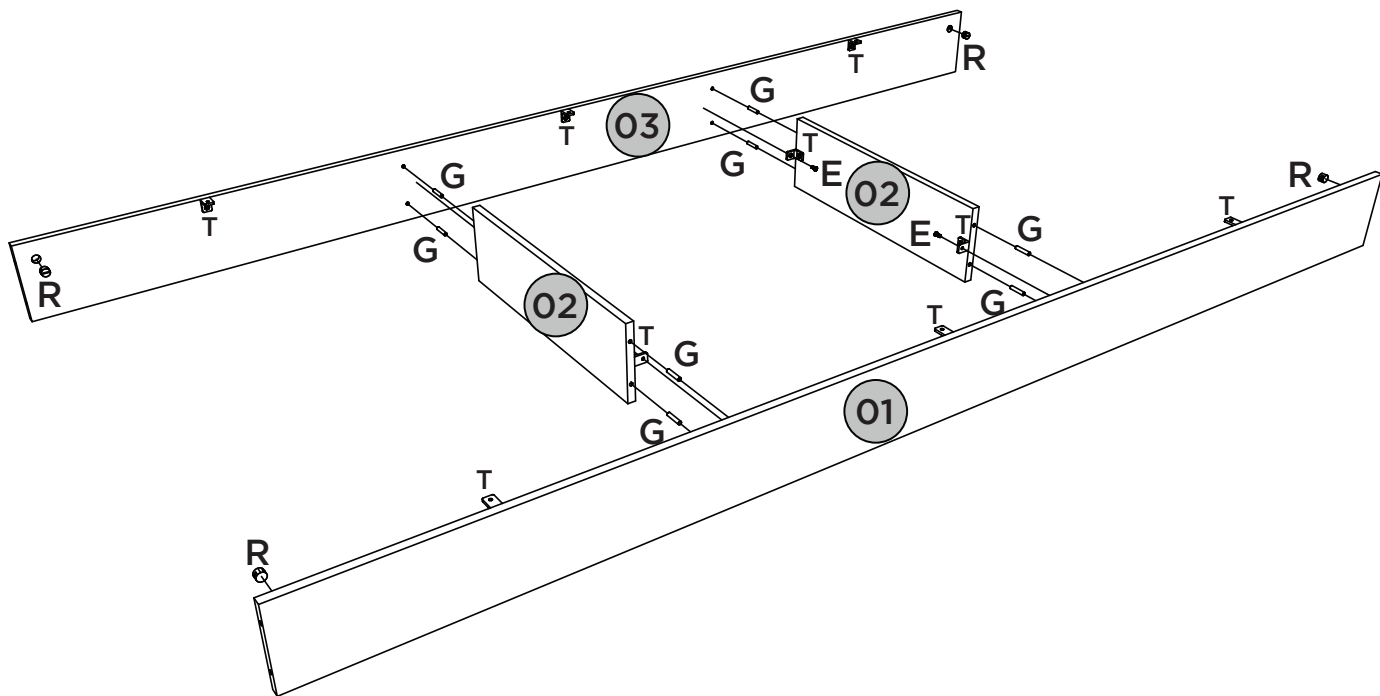

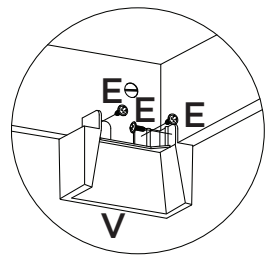
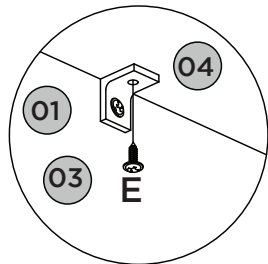
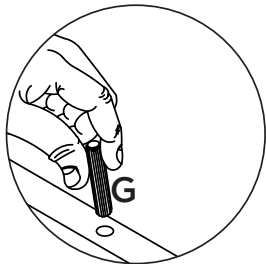
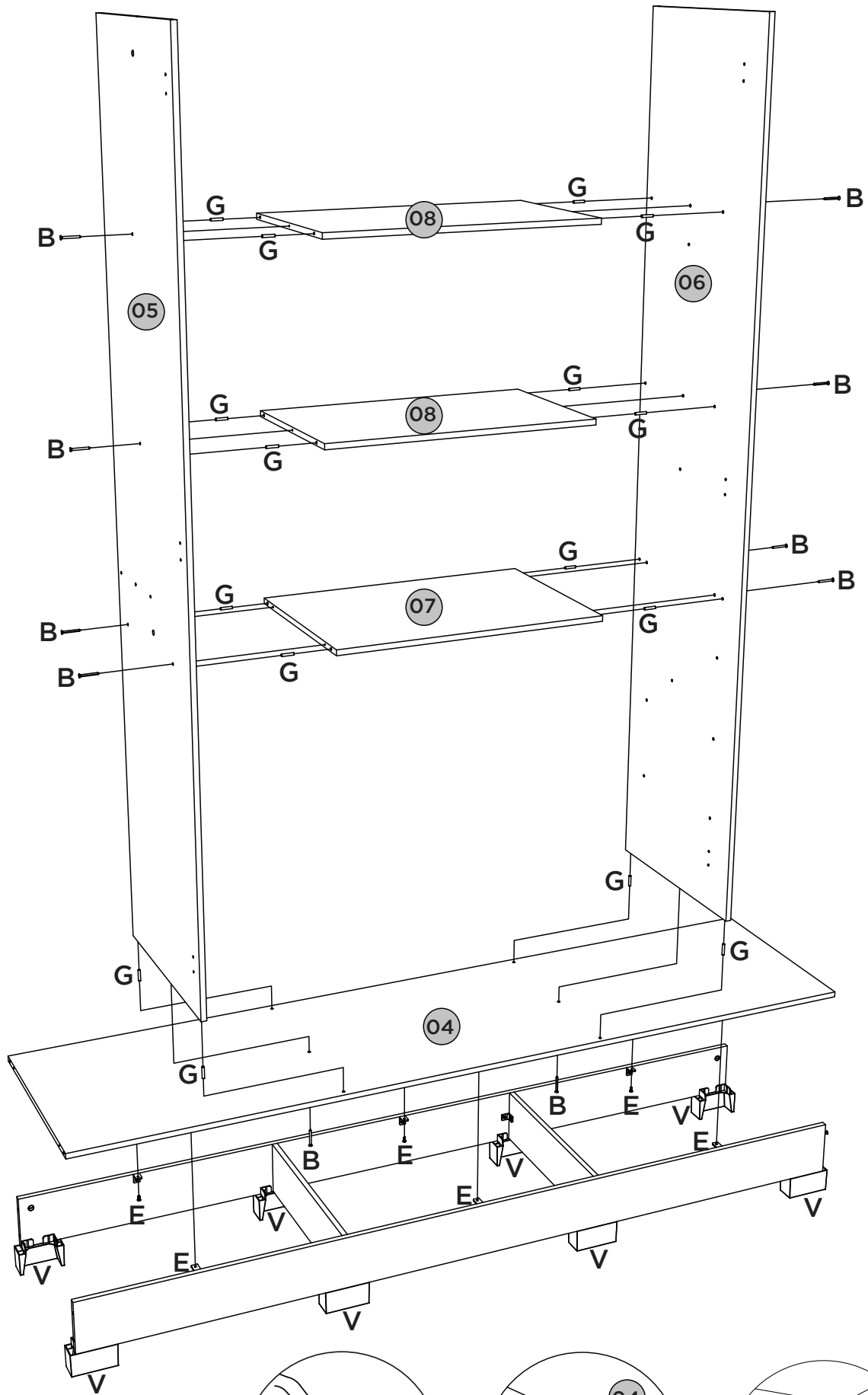

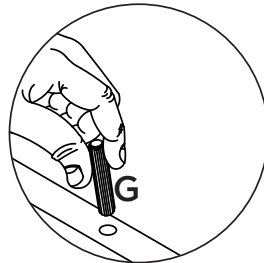
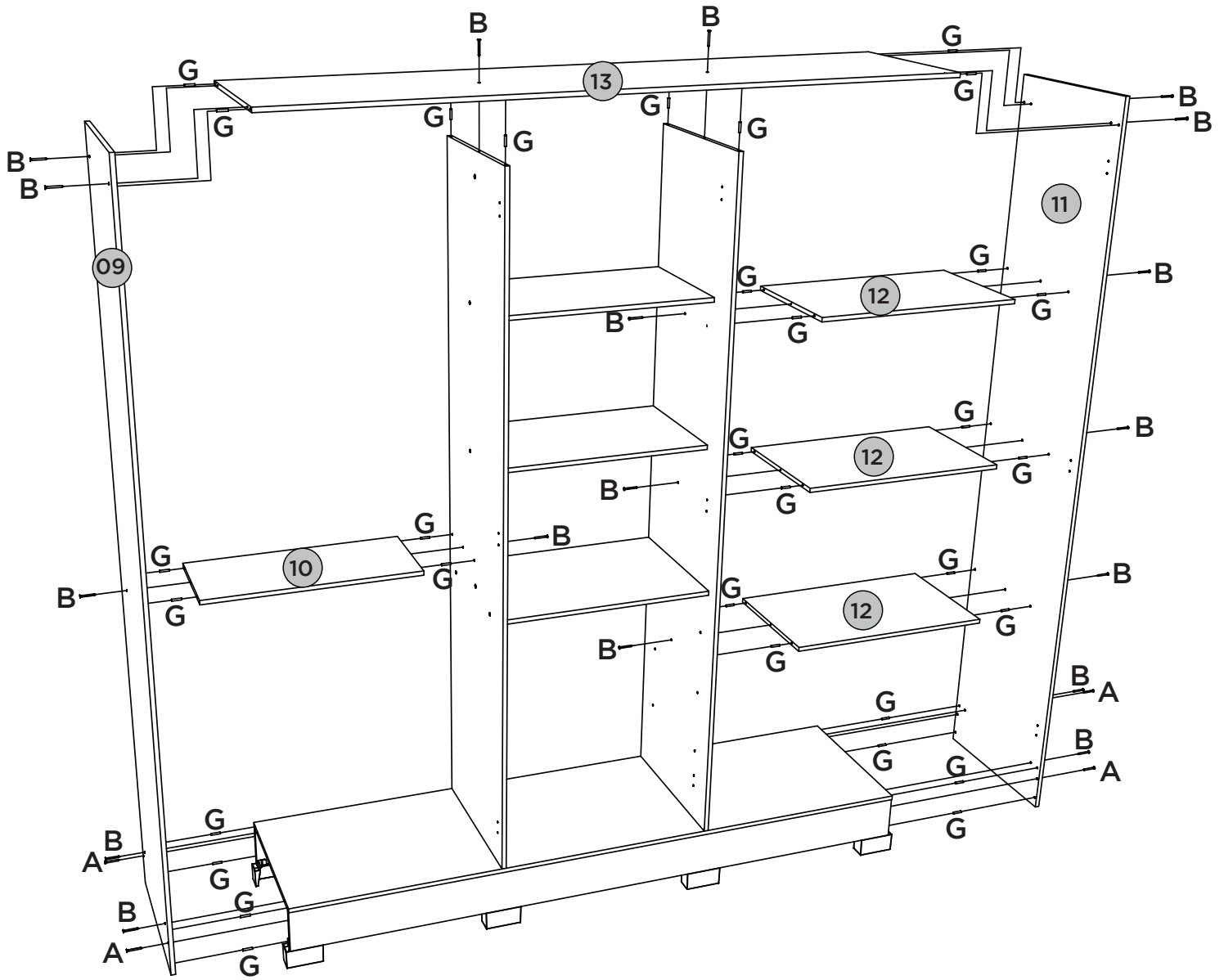

4

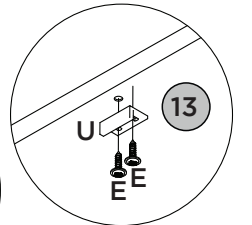
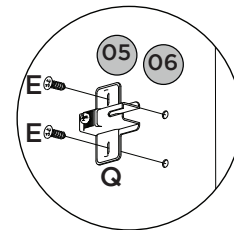
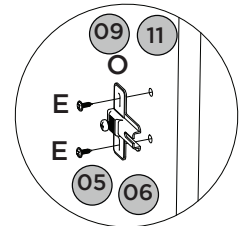
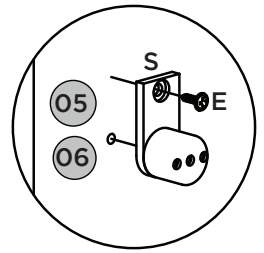
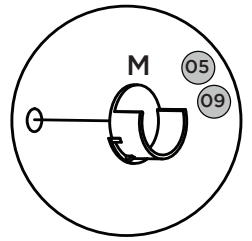
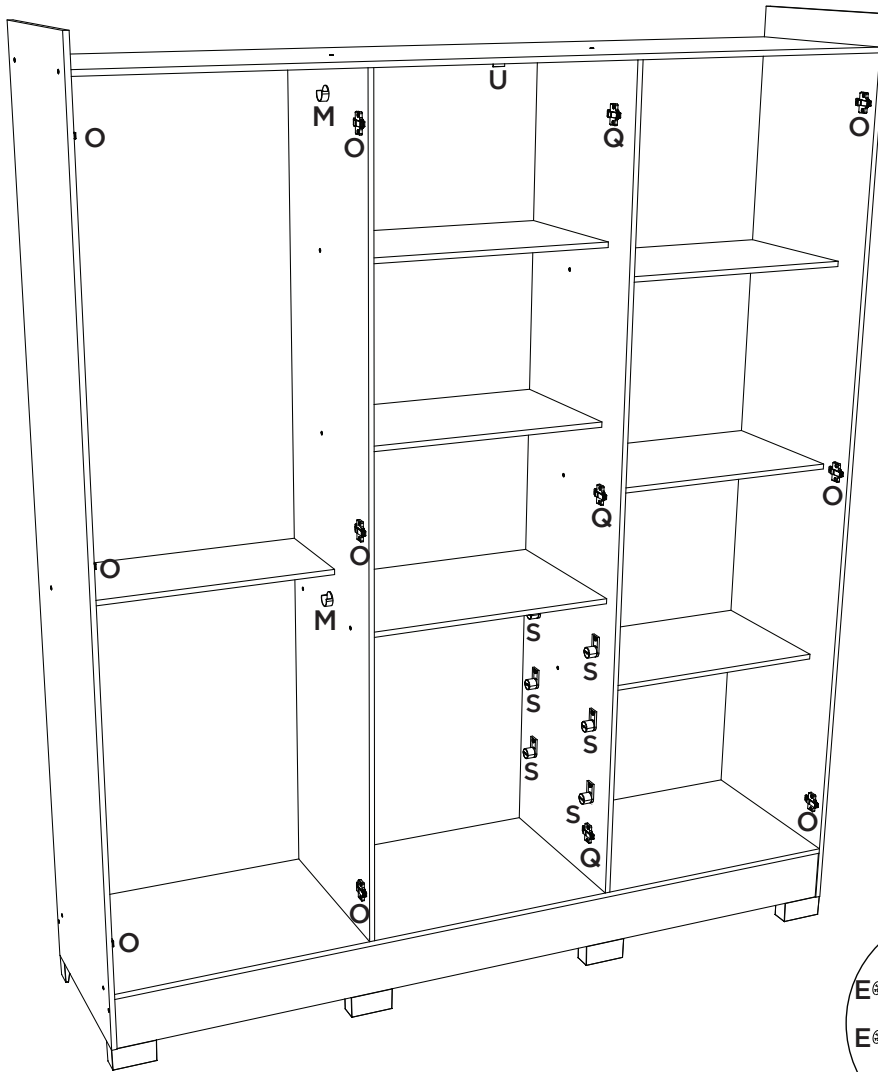

5

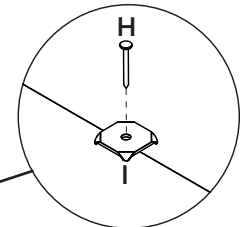
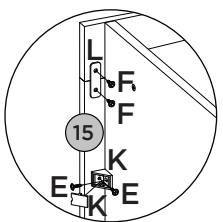
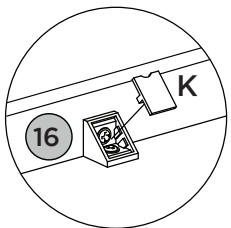
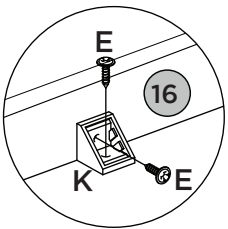
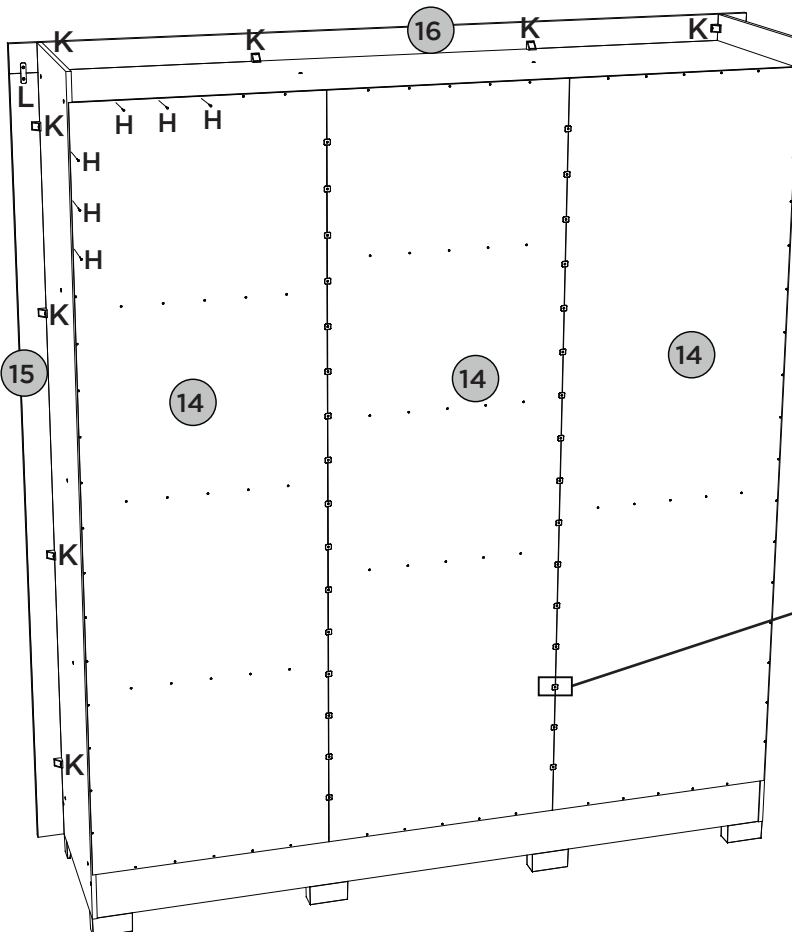

Fixar os pregos a uma distância de 120mm de um para outro.

Fijar las uñas a un distancia de 120 mm uno a otro.

Fix the nails at a distance of 120mm from one to the other

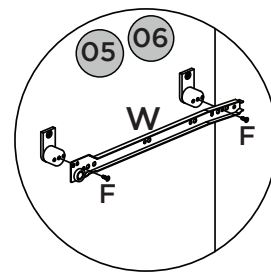
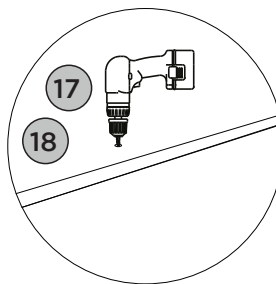
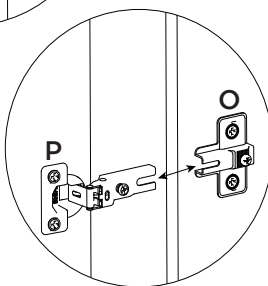
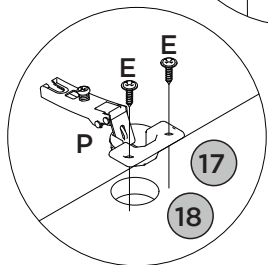
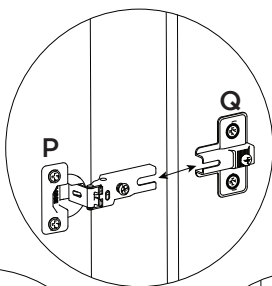

Vídeo: Instalar e regular Dobradiças

Video: Instale y ajuste las bisagras

Video: Install and adjust hinges

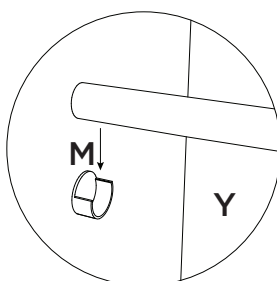

Vídeo: Dicas para instalar corredeira

Video: consejos para instalar la diapositiva

Video: Tips for installing slide

7

Vista Inferior

Vista Inferior

Bottom view

3x

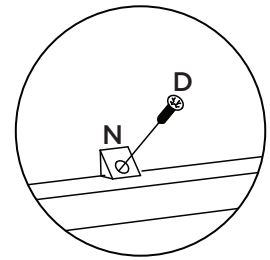
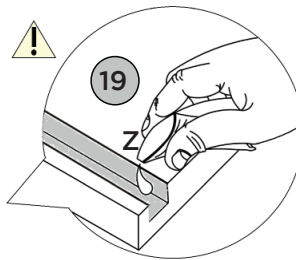
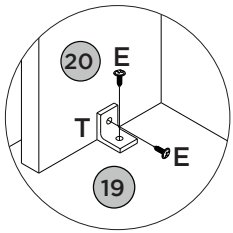
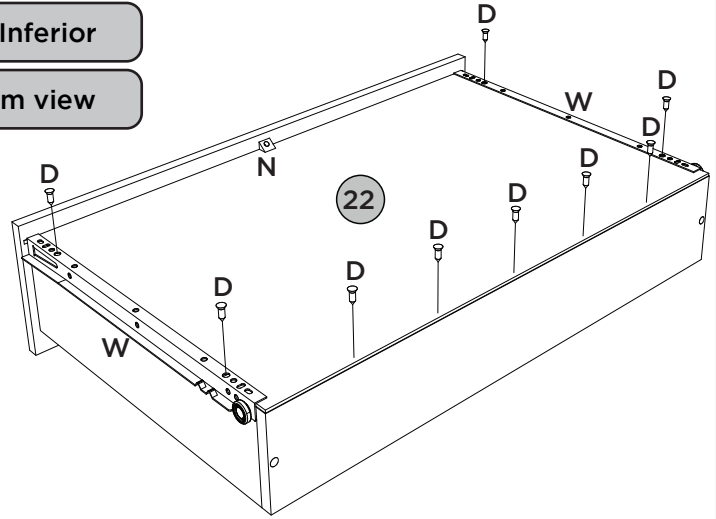
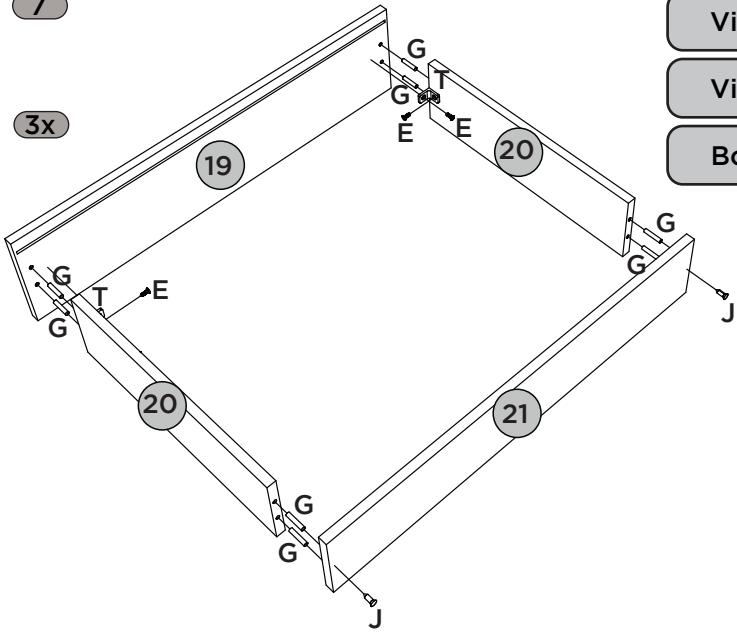

8

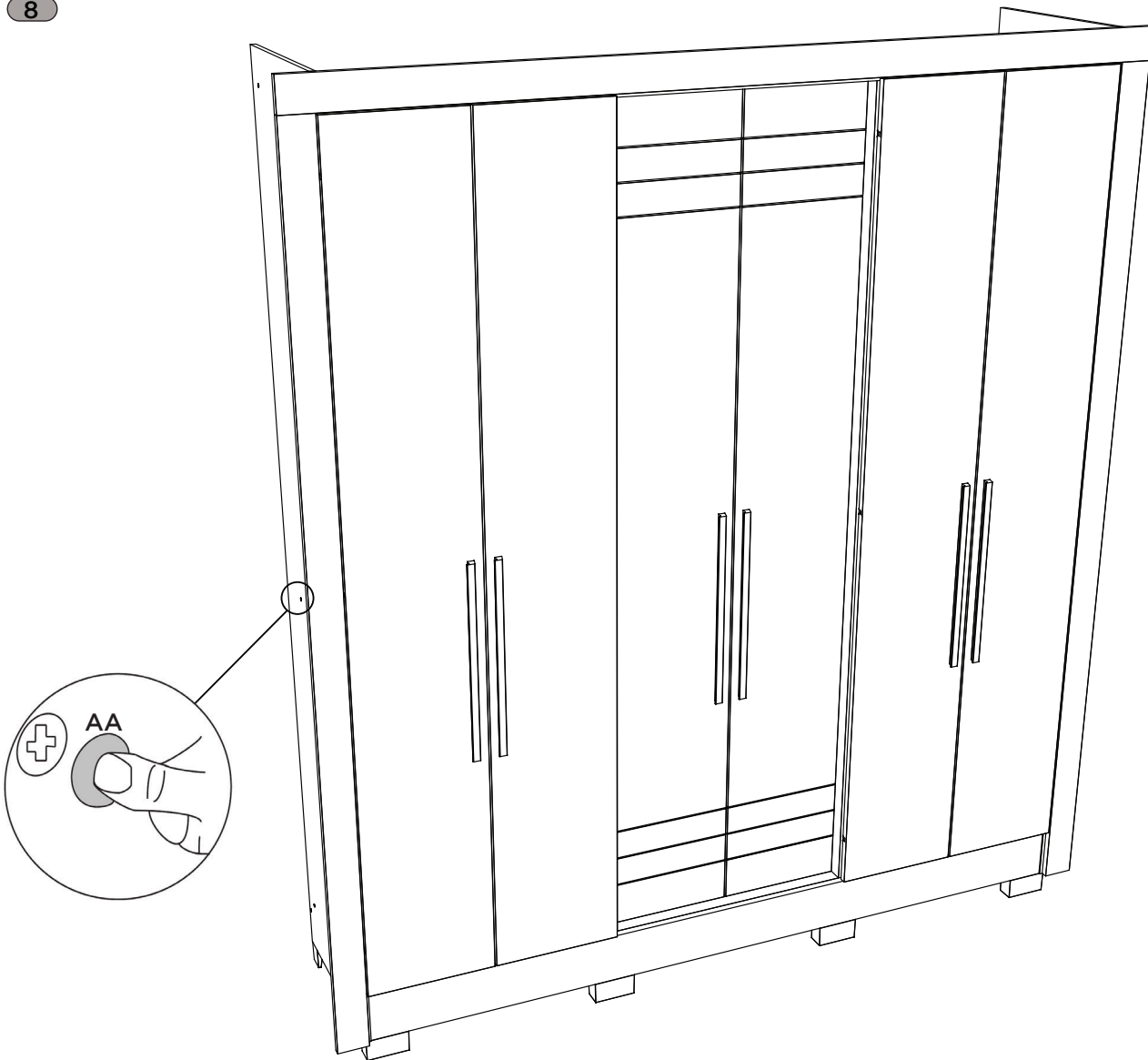















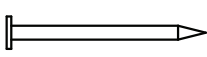
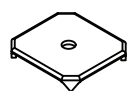



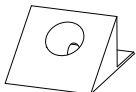
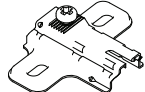
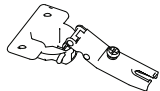

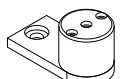
LISTA DE PEÇAS | LISTA DE PIEZAS | PARTS LIST

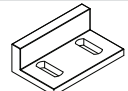
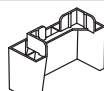
ITM/B366-Rev.000

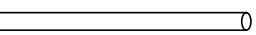
Item	Caixa Caja Box	Qtd Ctd Qty	Descrição Descripción Description	Medidas (mm) Dimensions (mm) Size (measurements) (mm)
1	2/2	01	Rodapé frontal Rodapié frontal Front footboards	1776x120x12
2	1/2	02	Travessa Rodapé Rodapié Bandeja Footboard Platter	415x120x12
3	2/2	01	Rodapé traseiro Rodapié trasero Rear footboard	1776x120x12
4	1/2	01	Base Base Base	1776x445x12
5	1/2	01	Divisão esquerda División izquierda Left division	1887x445x12
6	1/2	01	Divisão direita División derecha Right division	1887x445x12
7	1/2	01	Tampo das Gavetas Tapa del cajón Drawer Top	584x400x12
8=12	1/2	02	Prateleira Estante Shelf	584x350x12
9	2/2	01	Lateral esquerda Lateral izquierda Left side	2100x445x12
10	1/2	01	Prateleira do calceiro Estante de Calceiro Calceiro's Shelf	584x250x12
11	2/2	01	Lateral direita Lateral derecha Right side	2100x445x12
12=08	1/2	03	Prateleira Estante Shelf	584x350x12
13	1/2	01	Tampo Cubrir Cover	1776x445x12
14	2/2	03	Fundo Fondo Background	1909x597x3
15	1/2	02	Moldura Lateral Marco Lateral Lateral Frame	2027x73x15
16	1/2	01	Moldura Superior Marco Superior Frame Superior	1938x73x15
17	2/2	04	Porta Puerta Door	1897x295x15
18	2/2	02	Porta Central Puerta Central Central Door	1881x287x15
19	1/2	03	Frente de Gaveta Frente del Cajón Drawer Front	526x152x12
20	1/2	06	Lado de gaveta Lado del cajón Drawer side	350x100x12
21	1/2	03	Ripa de trás Listón trasero Rear batten	509x100x12
22	1/2	03	Fundo de gaveta recortado Fondo de cajón recortado Cropped drawer bottom	508x367x3

FERRAGENS | HERRAJES | HARDWARE

A 04x  Parafuso 4,5x50mm CHT. Tornillo 4,5x50mm CHT. Screw 4,5x50mm CHT.	B 28x  Parafuso 3,5x40mm CHT. Tornillo 3,5x40mm CHT. Screw 3,5x40mm CHT.	C 18x  Parafuso 3,5x25mm FLA. Tornillo 3,5x25mm FLA. Screw 3,5x25mm FLA.	D 30x  Parafuso 3,0x16mm CHT. Tornillo 3,0x16mm CHT. Screw 3,0x16mm CHT.	E 166x  Parafuso 3,5x12mm FLA. Tornillo 3,5x12mm FLA. Screw 3,5x12mm FLA.
F 16x  Parafuso 3,5x12mm CHT. Tornillo 3,5x12mm CHT. Screw 3,5x12mm CHT.	G 80x  Cavilha 5x25mm Cinta 5x25mm Dowel 5x25mm	H 134x  Prego 10x10mm Clavo 10x10mm Nail 10x10mm	I 30x  Fixador de fundos Fijador de fondos Bottom fixer	J 06x  Prego 12x12mm Anelado Clavo 12x12mm Anillado Ringed Nails 12x12mm
K 12x  Conector de montagem Conector de montaje Mounting connector	L 02x  Suporte metal Soporte metálico Metal support	M 04x  Suporte cabideiro Soporte de percha Coat hanger support	N 03x  Cantoneira Suporte Triangular Ángulo soporte triangular Triangular Support Angle	O 12x  Calço metal 5mm Calzado metálico 5mm 5mm metal shim
P 18x  Dobradiça metal 26 mm Bisagra de metal 26 mm 26 mm metal hinge	Q 06x  Calço metal 12mm Calzado metálico 12mm 12mm metal shim	R 04x  Porca cilíndrica Tuerca cilíndrica Cylindrical nut	S 12x  Distanciador de correção Distanciador de deslizamiento Sliding spacer	T 16x  Cantoneira plástica Cantoneira plástica Plastic angle brackets
U 01x  Batente 15x25mm Aldaba 15x25mm Door stop 15x25mm	V 08x  Pé "U" 50x40x100mm Pie "U" 50x40x100mm 50x40x100mm "U" feet	W PAR 03x  Correção metal 350mm Corredera metal 350mm Sliding metal 350mm	X 06x  Perfil Puxador Revestido MDF 450mm Perfil Tirador Revestido MDF 450mm Profile MDF 450mm Coated Handle	Y 02x  Cabideiro Madeira 578mm Cabezal Madera 578mm 578mm wooden hanger
Z 02x  Sachê de cola Bolsa de pegamento Glue bag	AA 28x  Adesivo tampa parafuso 10mm Adhesivo tapón de tornillo 10mm Bolt cover adhesive 10mm	AB 01x  Etiqueta resinada Briz Etiqueta resinada Briz Briz resin label		