



Ind. e Com. de Móveis Henn  
Mondai - SC - Brasil

+55 49 3674.3500

@moveishenn  
www.henn.com.br

## INSTRUÇÕES DE MONTAGEM

INSTRUCCIONES DE MONTAJE  
ASSEMBLY INSTRUCTIONS

### Roupeiro 06 Portas / Armario de 06 Puertas / 06 Door Wardrobe

- B367-127 Nature/Off White
- B367-128 Nature

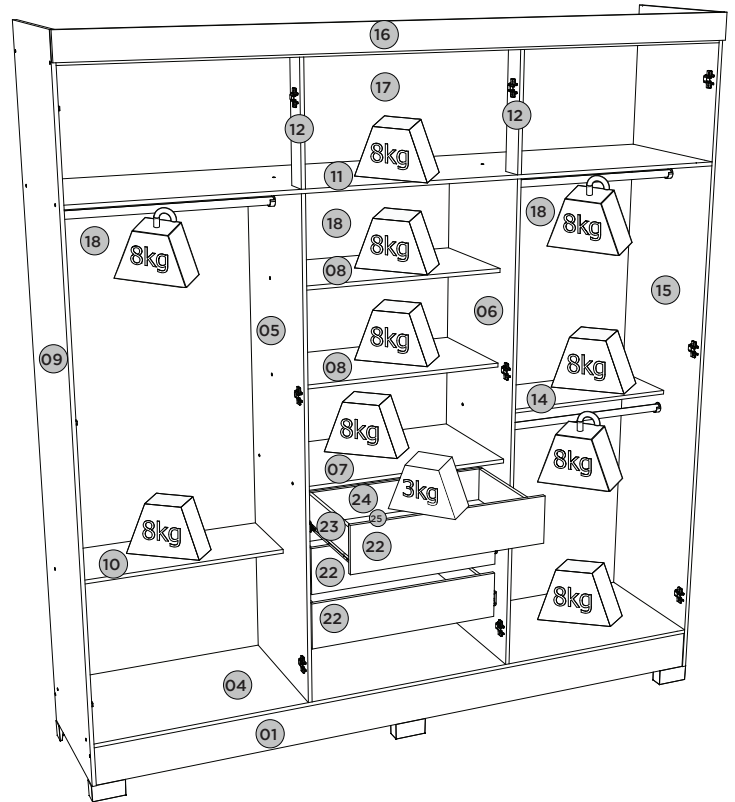
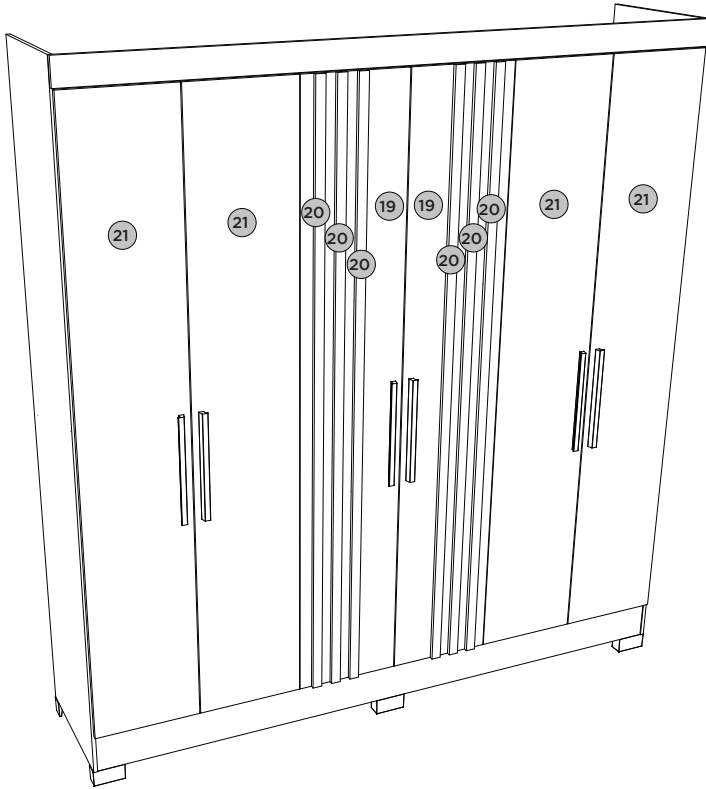

**Pesos máximos recomendados com carga distribuída**  
**Peso máximo recomendado con la carga distribuida**  
**Recommended maximum weights with evenly distributed.**

#### Requisitos para montagem Requisitos para la montaje Assembly Requirements

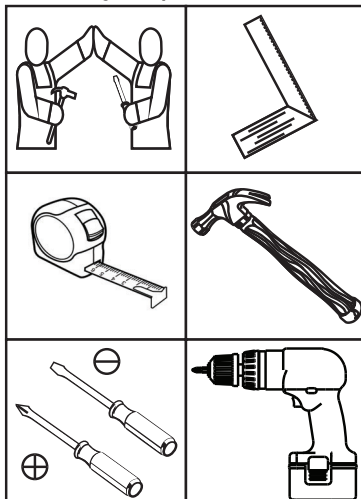

Imagens meramente ilustrativas,  
não acompanha o produto.  
Imágenes ilustrativas, no incluidas  
con el producto.  
Illustrative images, not included  
with the product.

#### AVISO

Para limpeza de seu móvel, use uma flanela seca ou umedecida, e não utilize produtos químicos que possam danificar seu produto.

#### SISTEMA DE MONTAGEM

O sistema de montagem dos produtos, funciona de acordo com a ordem crescente dos números indicados no desenho. Ex: 01, 02, 03, 04... até a conclusão da montagem.

#### ASSISTÊNCIA TÉCNICA

Para solicitação de Assistência Técnica você consumidor deverá entrar em contato com o Lojista o qual você realizou a compra deste produto e solicitar a assistência técnica das peças avariadas. A garantia abrange todas as peças, partes e componentes que eventualmente venham apresentar defeito de fabricação no prazo de 03 (três) meses, contando a partir da entrega do produto ao consumidor, mediante nota fiscal de compra. Se houver qualquer alteração na estrutura do produto ou ocorrer defeito por negligência do montador/consumidor em relação a instrução de montagem e manuseio, não será fornecido assistência técnica gratuita.

#### ADVERTENCIA

Para limpieza de su móvil, use una flanela seca o húmeda, y no utilice productos químicos que puedan dañar su producto.

#### SISTEMA DE MONTAJE

El sistema de montaje de los productos funciona de acuerdo con el orden creciente de los números indicados en el dibujo. Ej.: 01, 02, 03, 04... hasta la conclusión del montaje.

#### ASISTENCIA TÉCNICA

Para solicitar Asistencia Técnica, el consumidor debe comunicarse con el Comercio que usted realizó la compra de este producto y solicita asistencia técnica para las partes dañadas. La garantía cubre todas las partes, piezas y componentes que eventualmente puedan presentar defecto de fabricación en el plazo de 03 (tres) meses, contados a partir de la entrega del producto al consumidor, mediante factura de compra. Si se produce algún cambio en la estructura del producto o se produce un defecto por negligencia del montador/consumidor en relación con las instrucciones de montaje y manipulación, no se prestará asistencia técnica gratuita.

#### NOTICE

To clean your furniture, use a dry or wet cloth, and do not use chemicals that may damage your product.

#### ASSEMBLY SYSTEM

The products' assembly system works according to the increasing order of the indicated numbers. For example: 01, 02, 03, 04 ... to the end of the assembly.

#### TECHNICAL ASSISTANCE

To request Technical Assistance, the consumer must contact the retailer from whom you purchased this product and request technical assistance for the damaged parts. The warranty covers all parts, parts and components that may eventually present a manufacturing defect within a period of 03 (three) months, counting from the delivery of the product to the consumer, by means of a purchase invoice. If there is any change in the structure of the product or defect occurs due to negligence of the assembler/consumer in relation to the assembly and handling instruction, free technical assistance will not be provided.

1

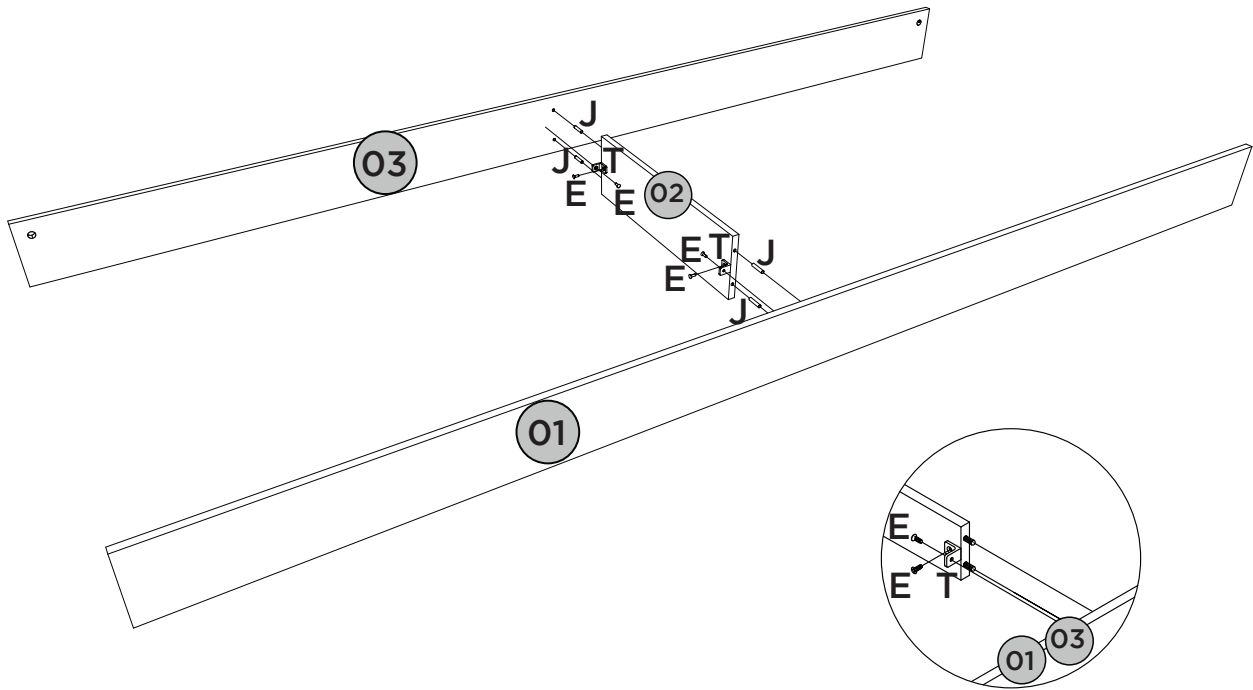

2

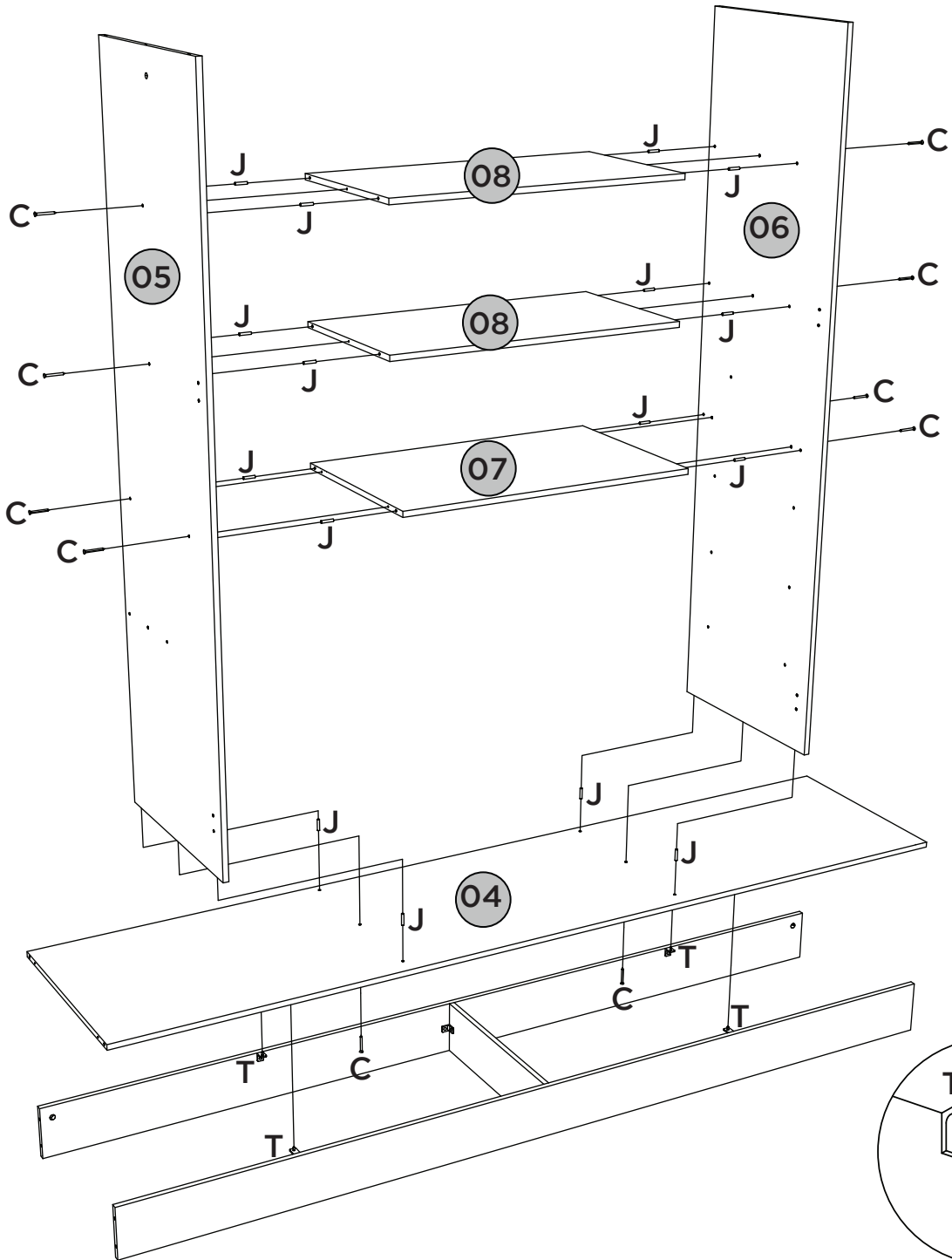

3

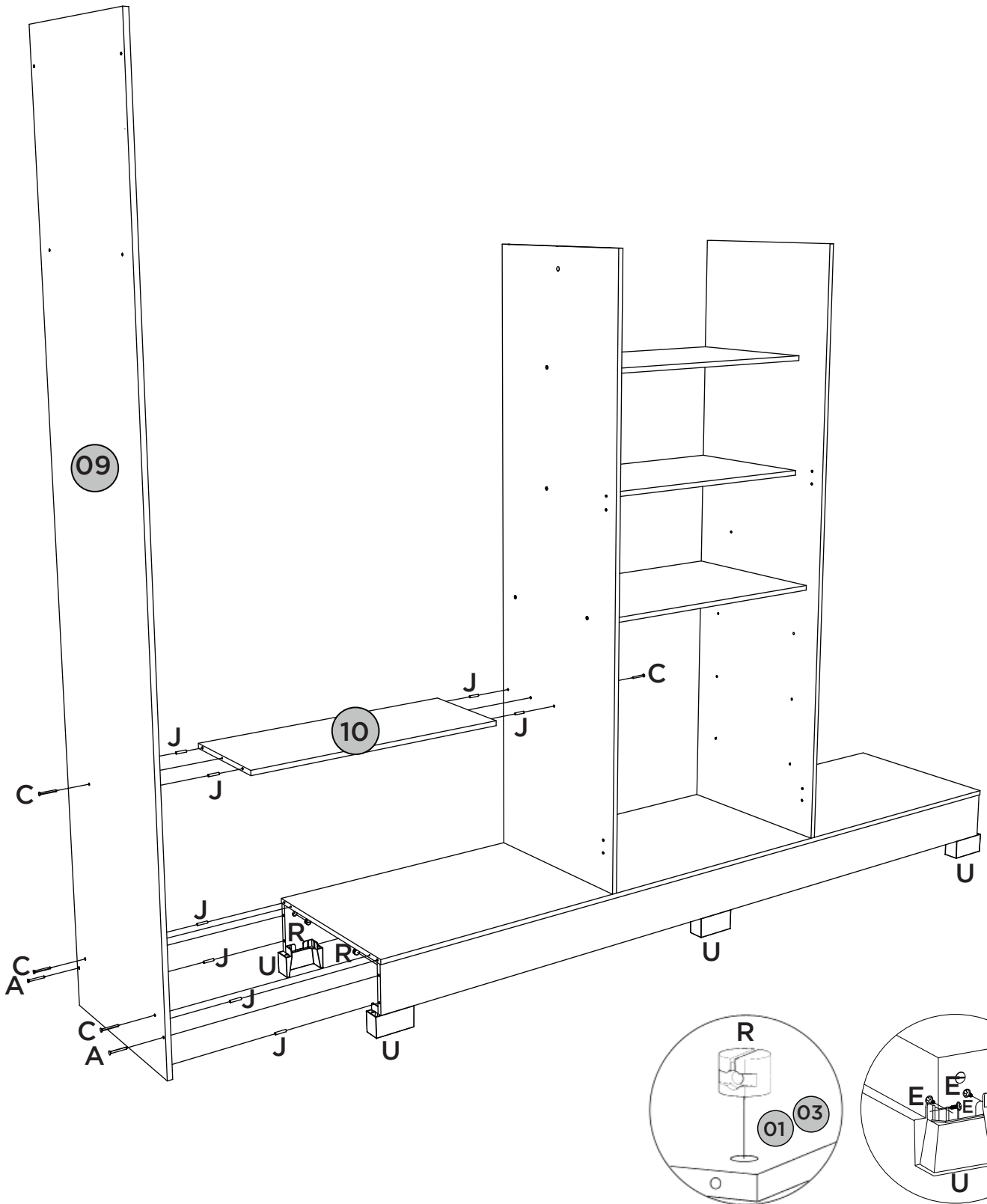

4

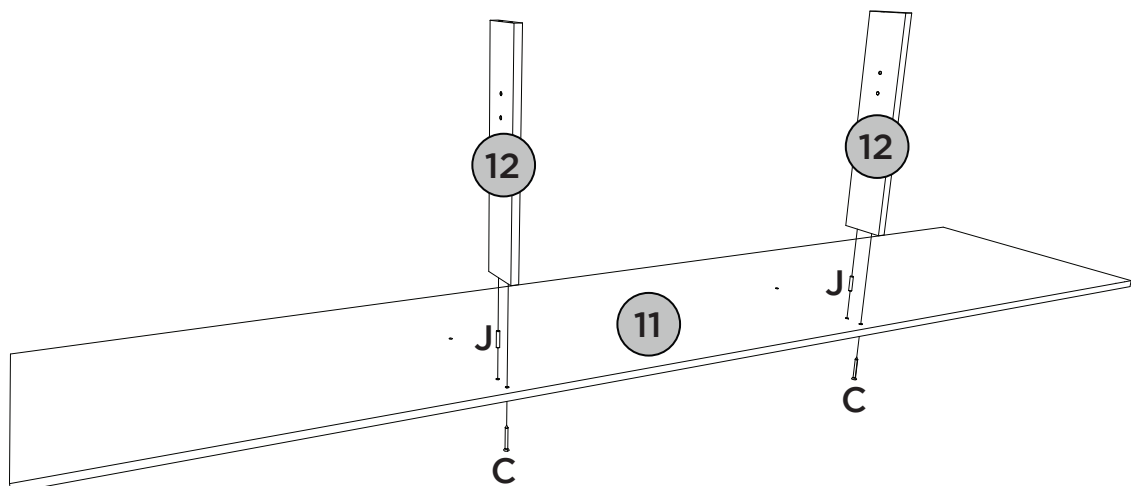

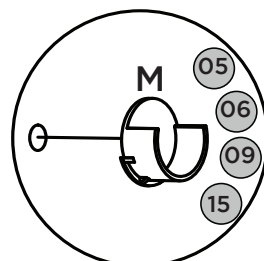
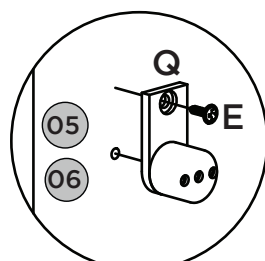
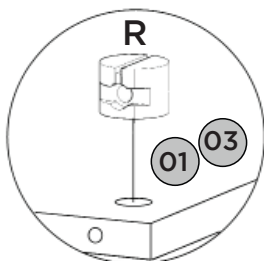
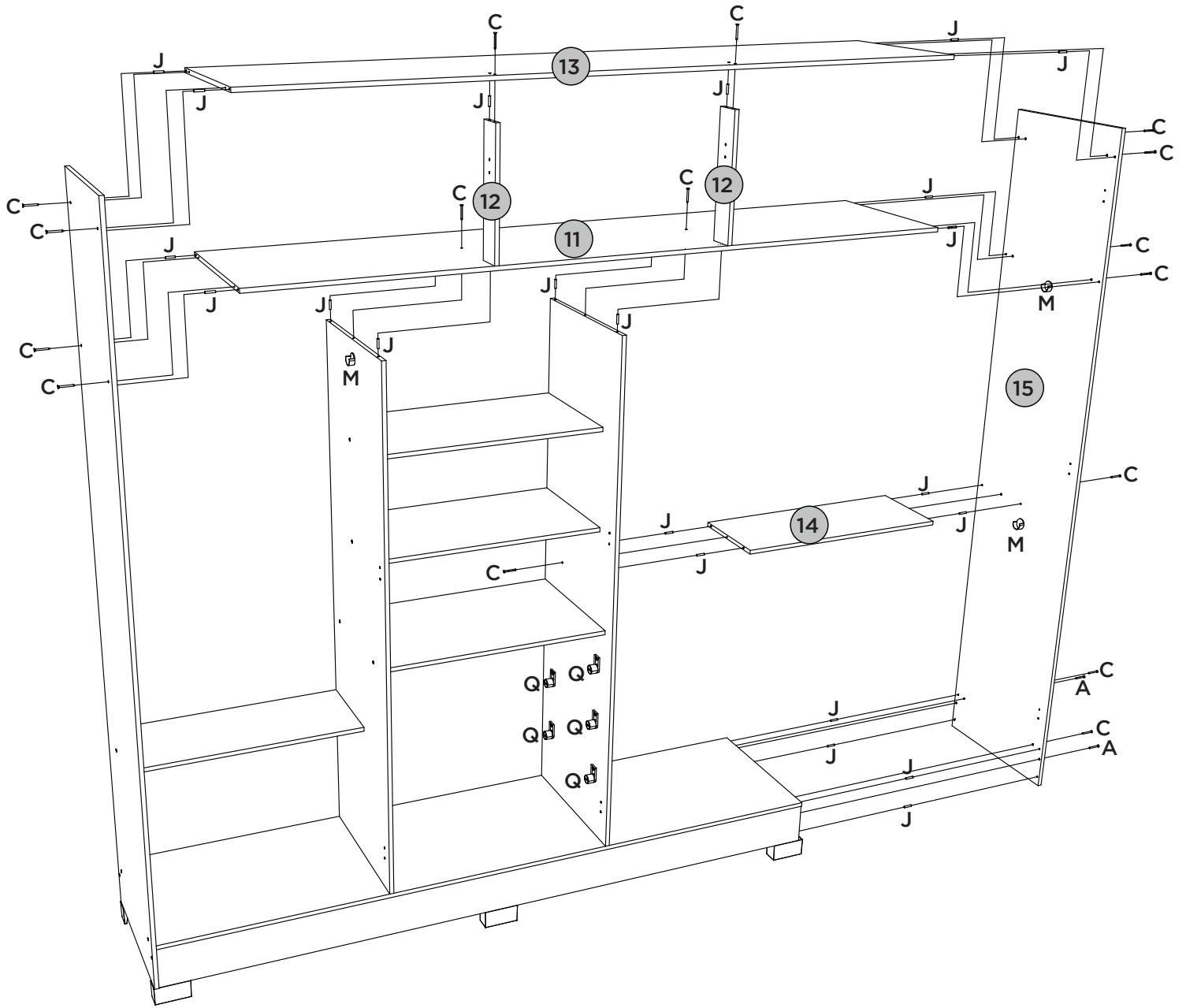

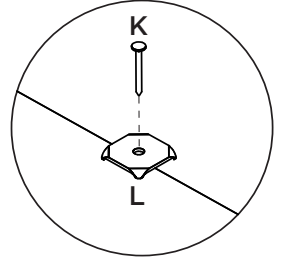
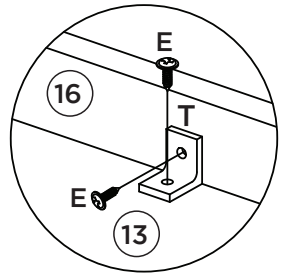
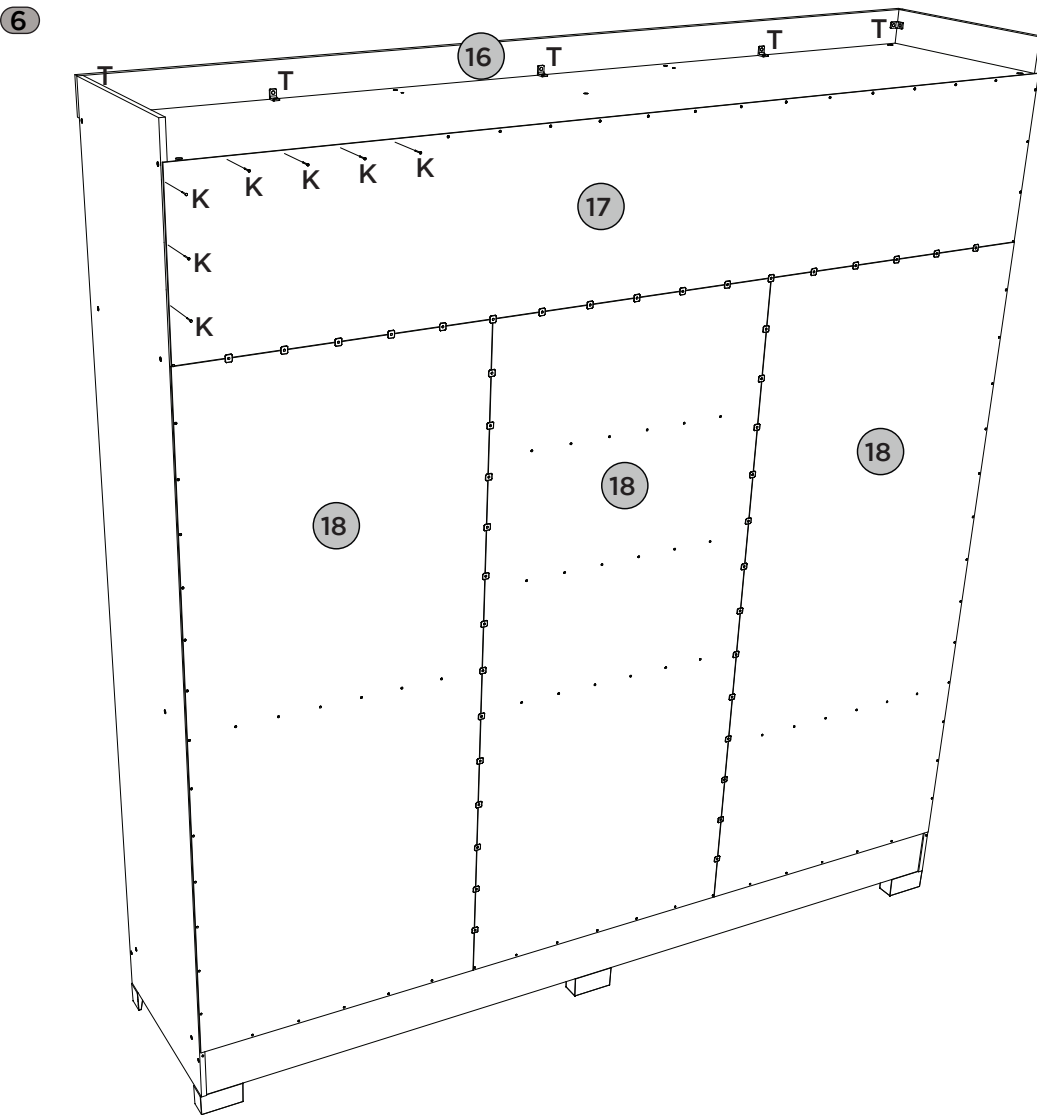

Fixar os pregos a uma distância de 120mm de um para outro.

Fijar las uñas a un distancia de 120 mm uno a otro.

Fix the nails at a distance of 120mm from one to the other

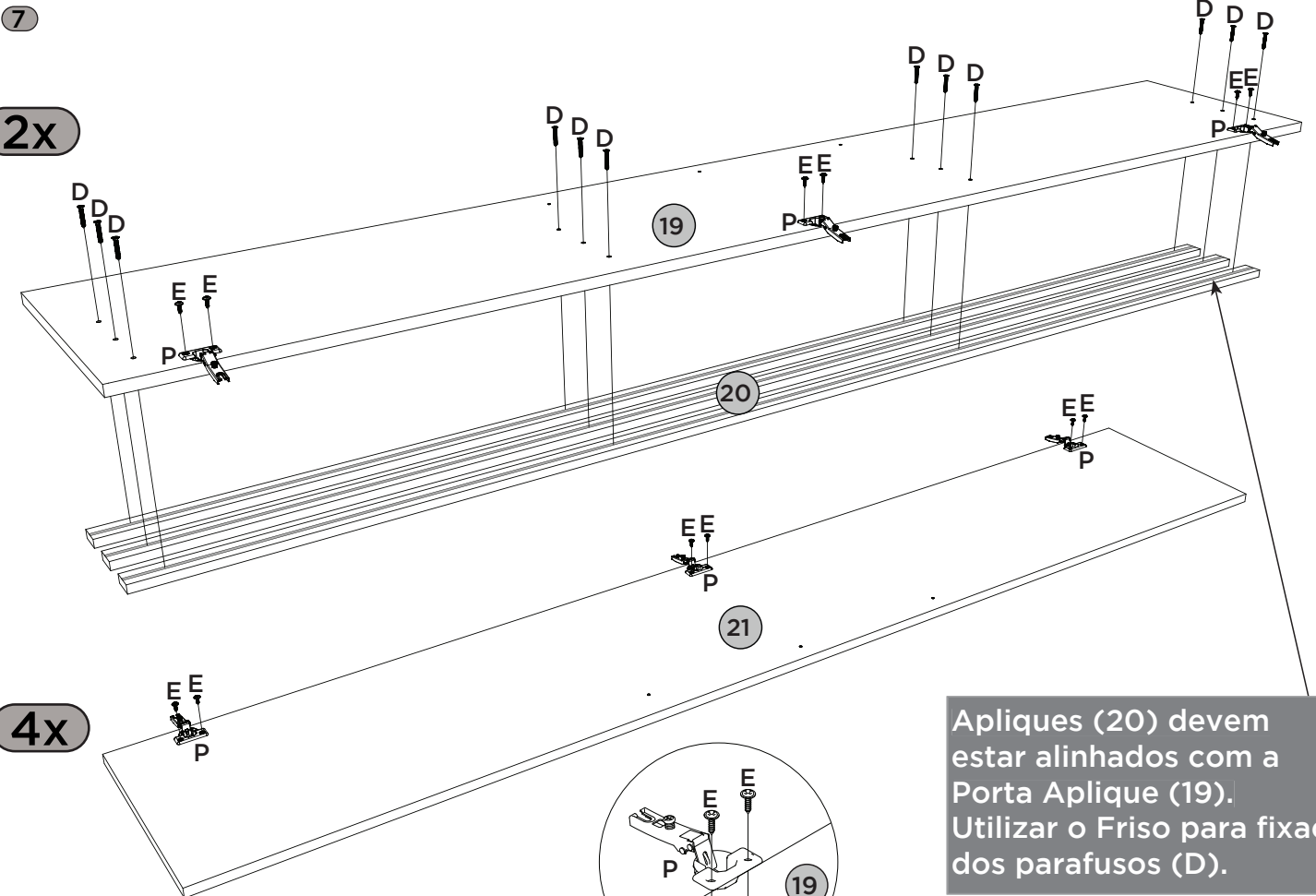

Apliques (20) devem estar alinhados com a Porta Aplique (19). Utilizar o Friso para fixação dos parafusos (D).

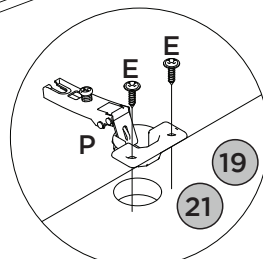

8

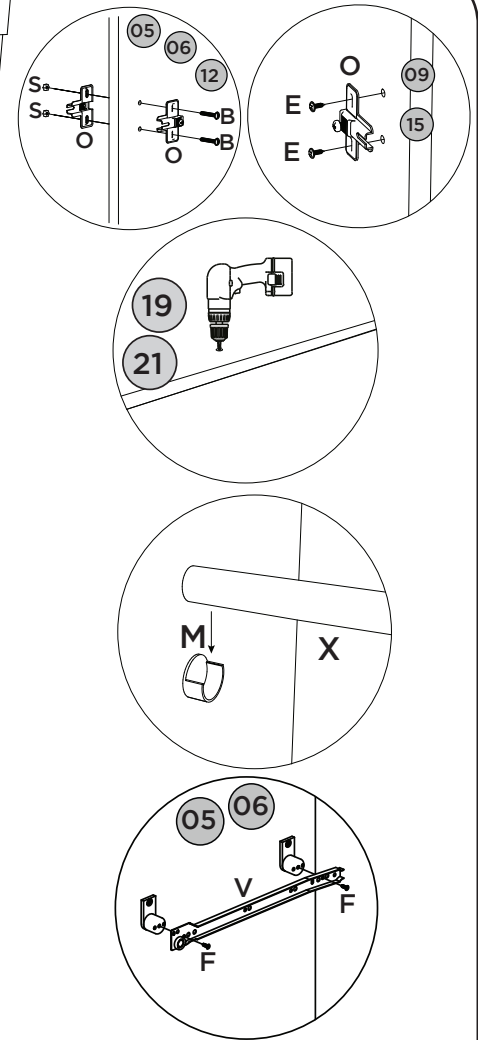
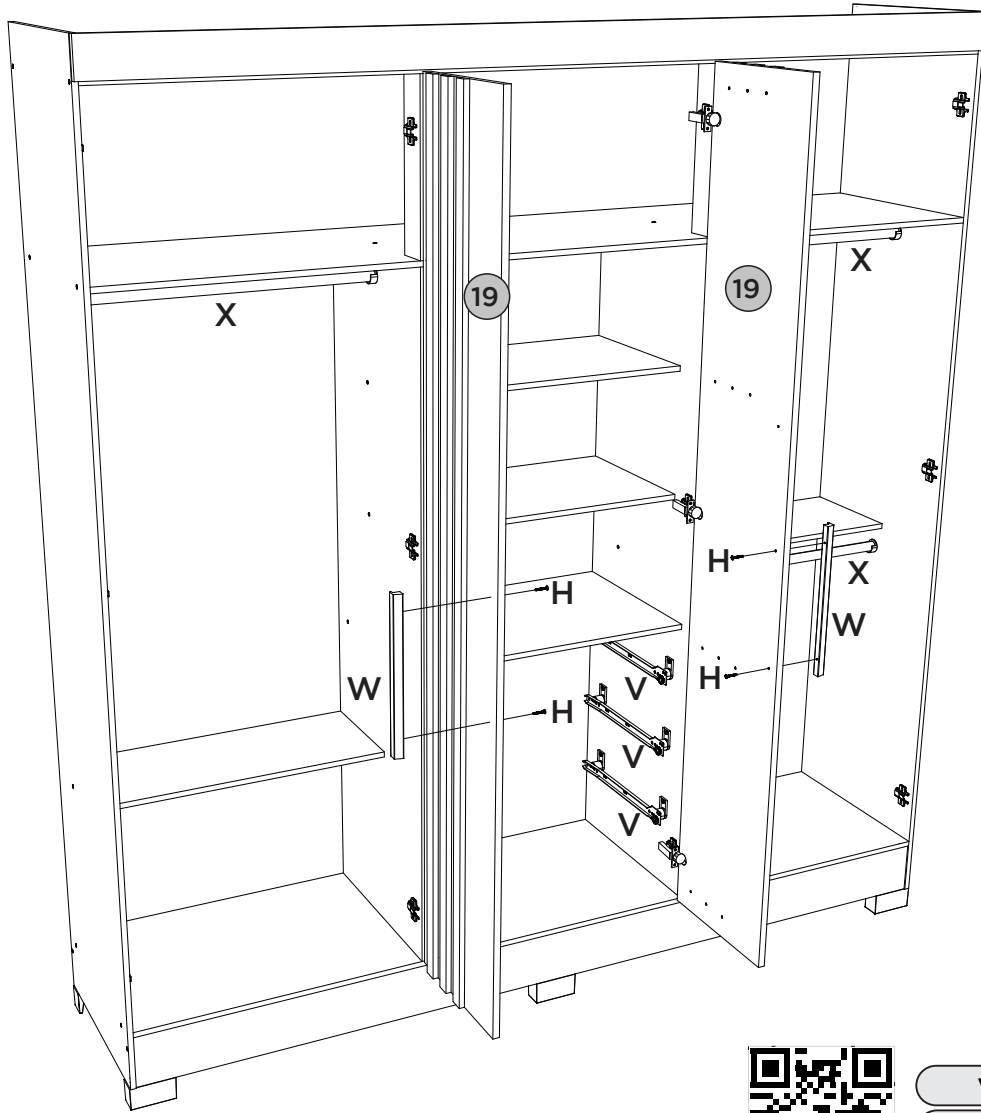

Vídeo: Dicas para instalar corredeira

Video: consejos para instalar la diapositiva

Video: Tips for installing slide

9

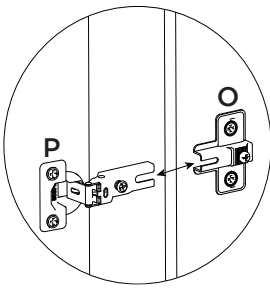

Vídeo: Instalar e regular Dobradiças

Video: Instale y ajuste las bisagras

Video: Install and adjust hinges

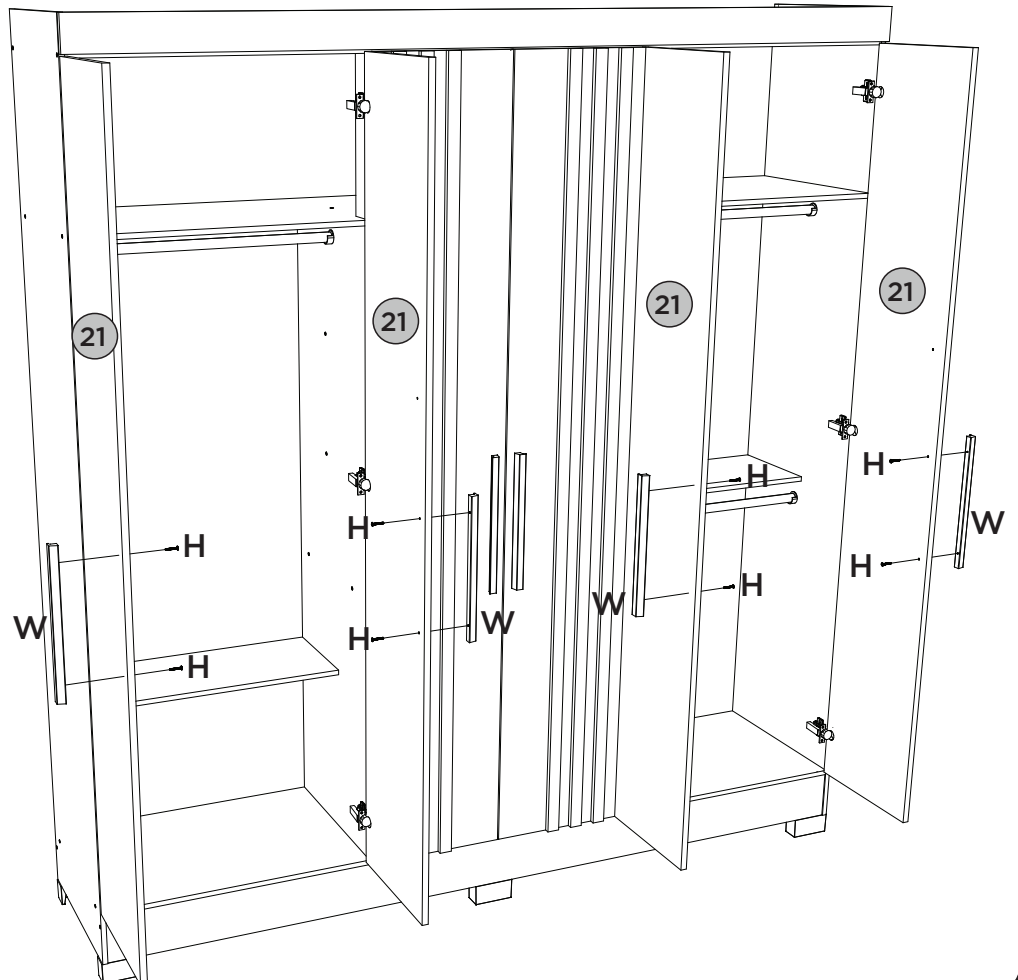

10

3x

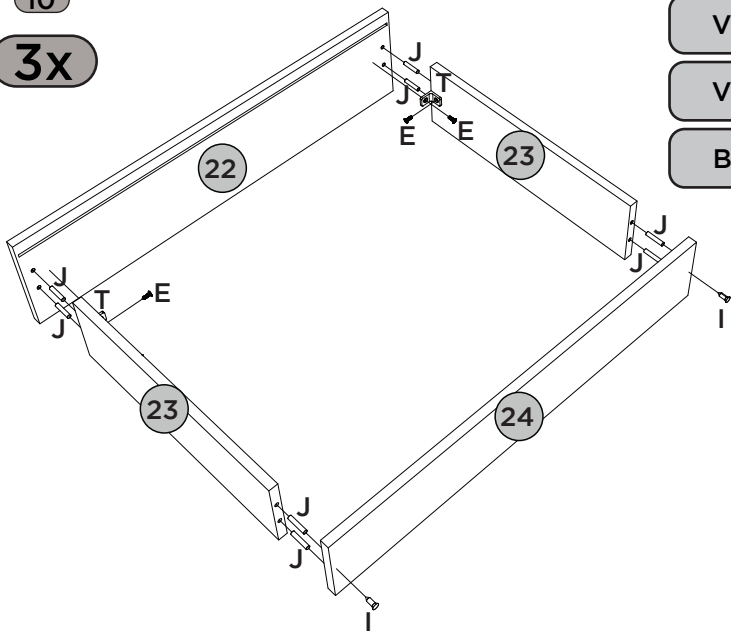

Vista Inferior  
 Vista Inferior  
 Bottom view

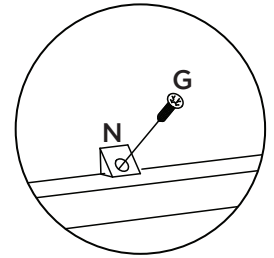
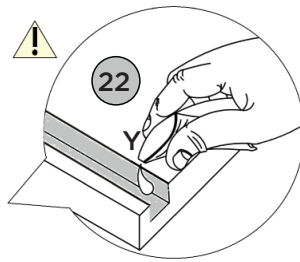
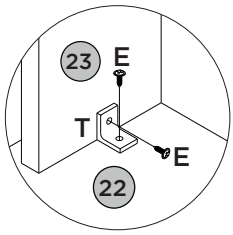
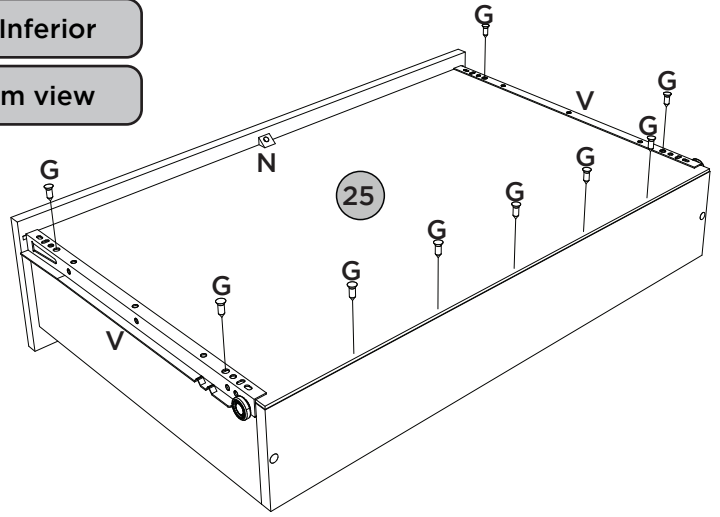



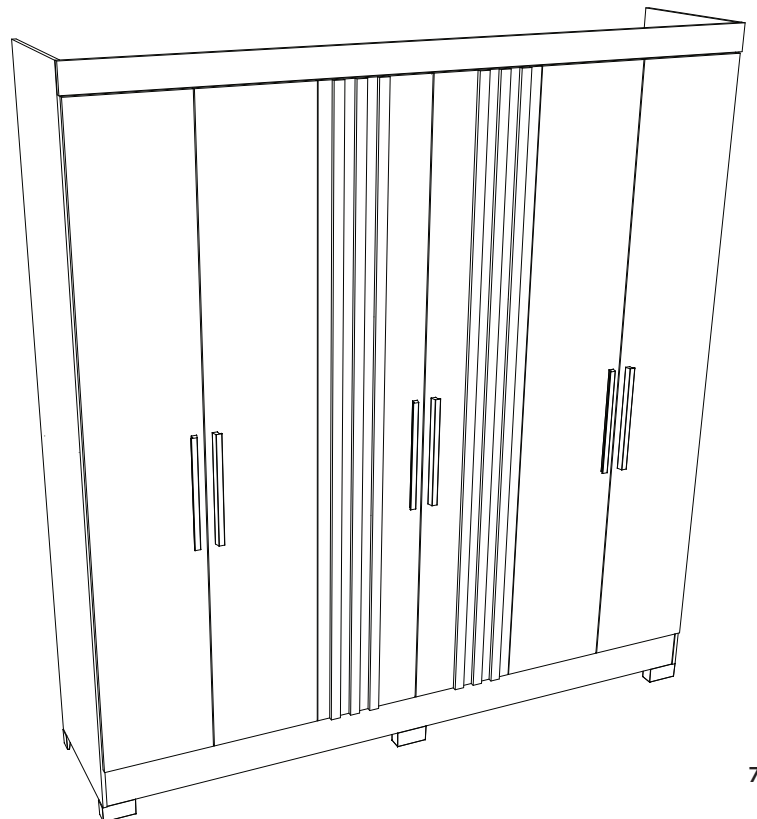
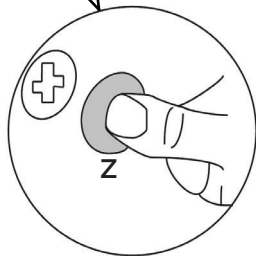
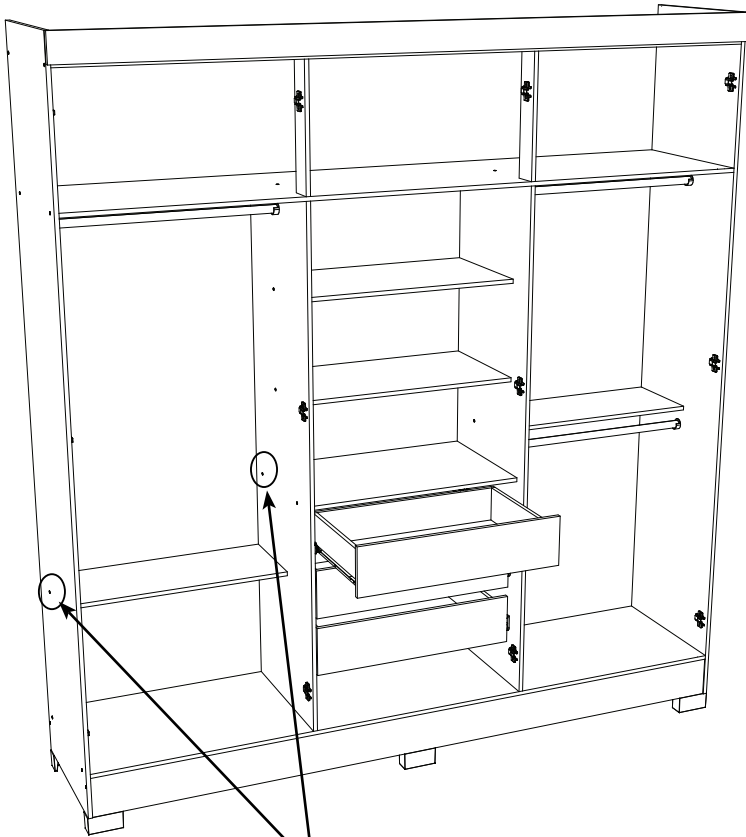







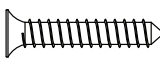





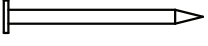

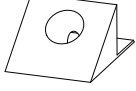
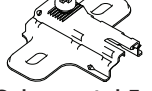
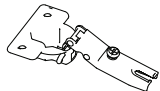
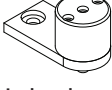
11

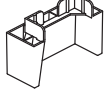

Item	Caixa Caja Box	Qty Ctd Qty	Descrição   Descripción   Description	Medidas (mm)   Dimensions (mm)   Size (measurements) (mm)
01	2/3	01	Rodapé frontal   Rodapié frontal   Front footboards	1971x120x12
02	1/3	01	Travessa Rodapé   Rodapié Bandeja   Footboard Platter	415x120x12
03	2/3	01	Rodapé traseiro   Rodapié trasero   Rear footboard	1971x120x12
04	2/3	01	Base   Base   Base	1971x445x12
05	1/3	01	Divisão esquerda   División izquierda   Left division	1518x445x12
06	1/3	01	Divisão direita   División derecha   Right division	1518x445x12
07	1/3	01	Tampo das Gavetas   Cubre los cajones   Drawer Top	649x400x12
08	1/3	02	Prateleira   Estante   Shelf	649x350x12
09	1/3	01	Lateral esquerda   Lateral izquierda   Left side	2100x445x12
10 = 14	1/3	01	Prateleira Menor   Estante más pequeño   Smaller Shelf	649x250x12
11	2/3	01	Chão do maleiro   piso del baúl   Floor of the closet top shelf	1971x445x12
12	1/3	02	Ripa do maleiro   listón maleiro   maleiro slat	350x73x12
13	2/3	01	Tampo   Cubrir   Cover	1971x445x12
14 = 10	1/3	01	Prateleira Menor   Estante más pequeño   Smaller Shelf	649x250x12
15	1/3	01	Lateral direita   Lateral derecha   Right side	2100x445x12
16	2/3	01	Chapéu   Sombrero   Hat	1993x80x15
17	2/3	01	Fundo Superior   Fondo Superior   Upper Fund	1989x367x3
18	3/3	03	Fundo   Fondo   Background	1536x662x3
19	3/3	02	Porta Aplique   Puerta con apliques   Applique Door	1888x328x15
20	2/3	06	Aplique   Aplicarse   Apply	1888x30x12
21	3/3	04	Porta   Puerta   Door	1888x328x15
22	2/3	03	Frente de Gaveta   Frente del Cajón   Drawer Front	607x145x12
23	1/3	06	Lado de gaveta   Lado del cajón   Drawer side	350x100x12
24	1/3	03	Ripa de trás   Listón trasero   Rear batten	574x100x12
25	1/3	03	Fundo de gaveta recortado   Fondo de cajón recortado   Cropped drawer bottom	573x367x3

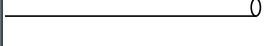
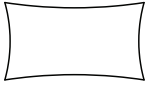
FERRAGENS | HERRAJES | HARDWARE

<b>A</b> 04x  Parafuso 4,5x50mm CHT. Tornillo 4,5x50mm CHT. Screw 4,5x50mm CHT.	<b>B</b> 12x  Parafuso 4,0x22mm FLA MET. Tornillo 4,0x22mm FLA MET. Screw 4,0x22mm FLA MET.	<b>C</b> 32x  Parafuso 3,5x40mm CHT. Tornillo 3,5x40mm CHT. Screw 3,5x40mm CHT.	<b>D</b> 24x  Parafuso 4,0x25mm CHT. Tornillo 4,0x25mm CHT. Screw 4,0x25mm CHT.	<b>E</b> 112x  Parafuso 3,5x12mm FLA. Tornillo 3,5x12mm FLA. Screw 3,5x12mm FLA.
<b>F</b> 12x  Parafuso 3,5x12mm CHT. Tornillo 3,5x12mm CHT. Screw 3,5x12mm CHT.	<b>G</b> 30x  Parafuso 3,0x16mm CHT. Tornillo 3,0x16mm CHT. Screw 3,0x16mm CHT.	<b>H</b> 12x  Parafuso 3,5x25mm FLA. Tornillo 3,5x25mm FLA. Screw 3,5x25mm FLA.	<b>I</b> 06x  Prego 12x12mm Anelado Clavo 12x12mm Anillado Ringed Nails 12x12mm	<b>J</b> 76x  Cavilha 5x25mm Cinta 5x25mm Dowel 5x25mm
<b>K</b> 137x  Prego 10x10mm Clavo 10x10mm Nail 10x10mm	<b>L</b> 40x  Fixador de fundos Fijador de fondos Bottom fixer	<b>M</b> 06x  Suporte cabideiro Soporte de percha Coat hanger support	<b>N</b> 03x  Cantoneira Suporte Triangular Angulo sopote triangular Triangular Support Angle	<b>O</b> 18x  Calço metal 5mm Calzado metálico 5mm 5mm metal shim
<b>P</b> 18x  Dobradiça metal 26 mm Bisagra de metal 26 mm 26 mm metal hinge	<b>Q</b> 12x  Distanciador de correção Distanciadore de deslizamiento Sliding spacer	<b>R</b> 04x  Porca cilíndrica Tuerca cilíndrica Cylindrical nut	<b>S</b> 12x  Porca sextavada Tuerca hexagonal Hexagon nuts	<b>T</b> 17x  Cantoneira plástica Cantonera plástica Plastic angle brackets
<b>U</b> 06x  Pé "U" 50x40x100mm Pie "U" 50x40x100mm 50x40x100mm "U" feet	<b>V</b> PAR 03x  Correção metal 350mm Corredera metal 350mm Sliding metal 350mm	<b>W</b> 06x  Perfil Puxador Revestido 330mm Perfil Mango Revestido 330mm Coated Handle Profile 330mm	<b>X</b> 03x  Cabideiro Madeira 643mm Cabezal Madera 643mm 643mm wooden hanger	<b>Y</b> 02x  Sachê de cola Bolsa de pegamento Glue bag
<b>Z</b> 54x  Adesivo tapa parafuso 10mm Adhesivo tapón de tornillo 10mm Bolt cover adhesive 10mm	<b>AA</b> 01x  Etiqueta resinada Briz Etiqueta resinada Briz Briz resin label			