

Roupeiro 06 Portas / Armario de 06 Puertas / 06 Door Wardrobe

- B355-130 Castanho HP
- B355-198 Jequitibá Brilho

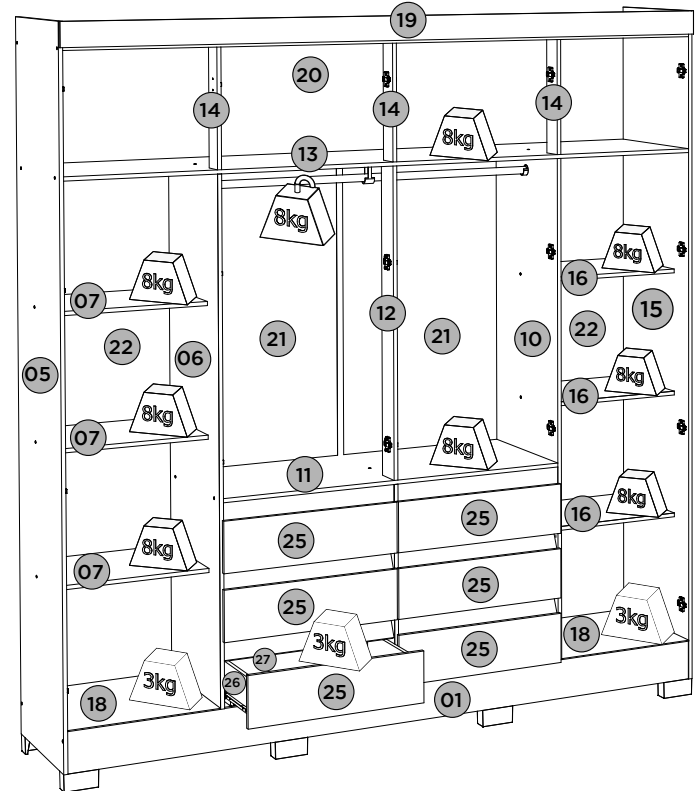

**Pesos máximos recomendados com carga distribuída**  
**Peso máximo recomendado con la carga distribuida**  
**Recommended maximum weights with evenly distributed.**

Requisitos para montagem  
Requisitos para la montaje  
Assembly Requirements

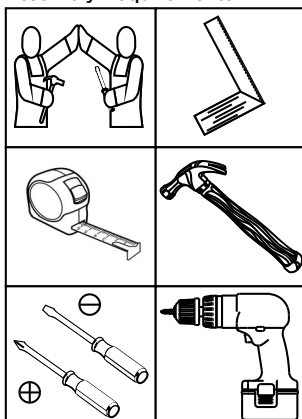

Imagens meramente ilustrativas,  
não acompanha o produto.  
Imágenes ilustrativas, no incluidas  
con el producto.  
Illustrative images, not included  
with the product.

AVISO

Para limpeza de seu móvel, use uma flanela seca ou umedecida, e não utilize produtos químicos que possam danificar seu produto.

SISTEMA DE MONTAGEM

O sistema de montagem dos produtos, funciona de acordo com a ordem crescente dos números indicados no desenho. Ex: 01, 02, 03, 04... até a conclusão da montagem.

ASSISTÊNCIA TÉCNICA

Para solicitação de Assistência Técnica você consumidor deverá entrar em contato com o Lojista o qual você realizou a compra deste produto e solicitar a assistência técnica das peças avariadas. A garantia abrange todas as peças, partes e componentes que eventualmente venham apresentar defeito de fabricação no prazo de 03 (três) meses, contando a partir da entrega do produto ao consumidor, mediante nota fiscal de compra. Se houver qualquer alteração na estrutura do produto ou ocorrer defeito por negligência do montador/consumidor em relação a instrução de montagem e manuseio, não será fornecido assistência técnica gratuita.

ADVERTENCIA

Para limpieza de su móvil, use una flanela seca o húmeda, y no utilice productos químicos que puedan dañar su producto.

SISTEMA DE MONTAJE

El sistema de montaje de los productos funciona de acuerdo con el orden creciente de los números indicados en el dibujo. Ej.: 01, 02, 03, 04... hasta la conclusión del montaje.

ASISTENCIA TÉCNICA

Para solicitar Asistencia Técnica, el consumidor debe comunicarse con el Comercio que usted realizó la compra de este producto y solicita asistencia técnica para las partes dañadas. La garantía cubre todas las partes, piezas y componentes que eventualmente puedan presentar defecto de fabricación en el plazo de 03 (tres) meses, contados a partir de la entrega del producto al consumidor, mediante factura de compra. Si se produce algún cambio en la estructura del producto o se produce un defecto por negligencia del montador/consumidor en relación con las instrucciones de montaje y manipulación, no se prestará asistencia técnica gratuita.

NOTICE

To clean your furniture, use a dry or wet cloth, and do not use chemicals that may damage your product.

ASSEMBLY SYSTEM

The products' assembly system works according to the increasing order of the indicated numbers. For example: 01, 02, 03, 04 ... to the end of the assembly.

TECHNICAL ASSISTANCE

To request Technical Assistance, the consumer must contact the retailer from whom you purchased this product and request technical assistance for the damaged parts. The warranty covers all parts, parts and components that may eventually present a manufacturing defect within a period of 03 (three) months, counting from the delivery of the product to the consumer, by means of a purchase invoice. If there is any change in the structure of the product or defect occurs due to negligence of the assembler/consumer in relation to the assembly and handling instruction, free technical assistance will not be provided.

1

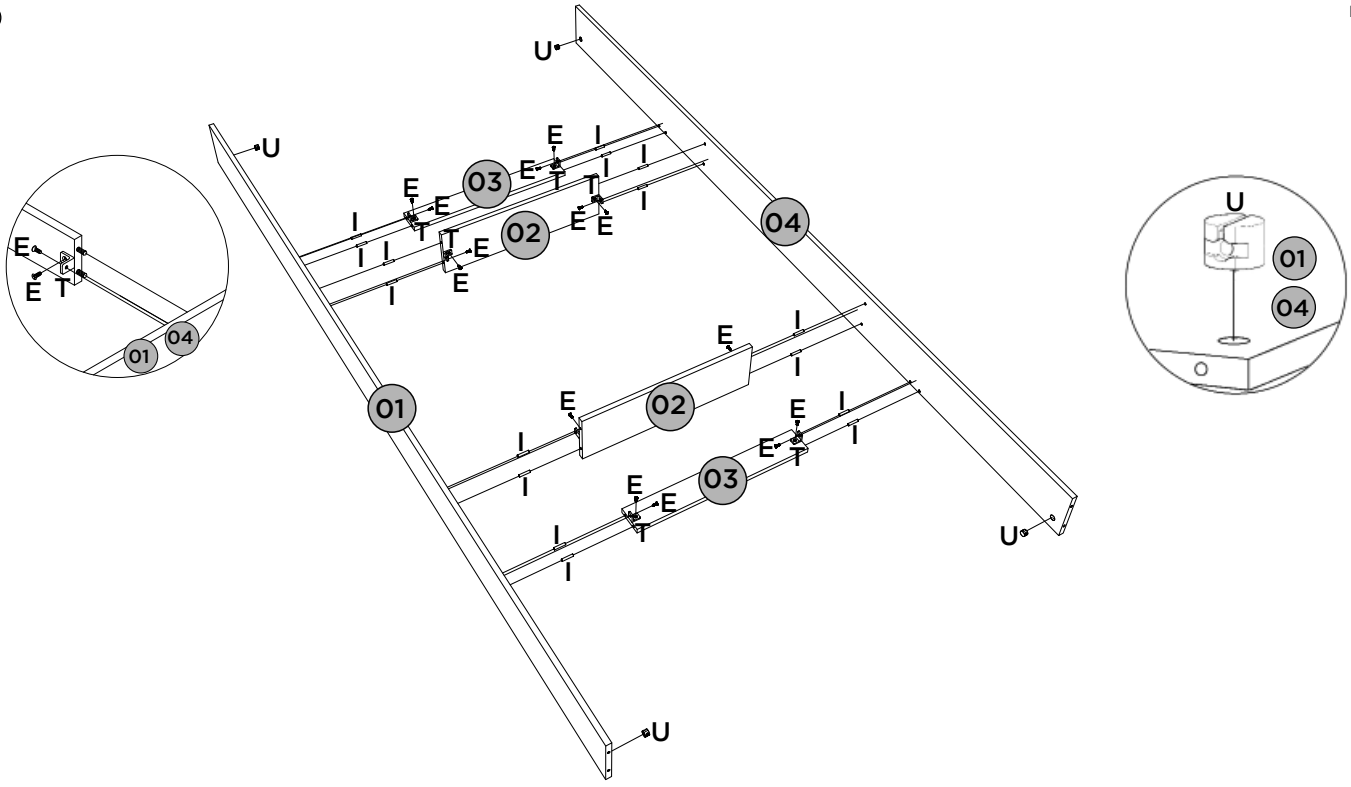

2

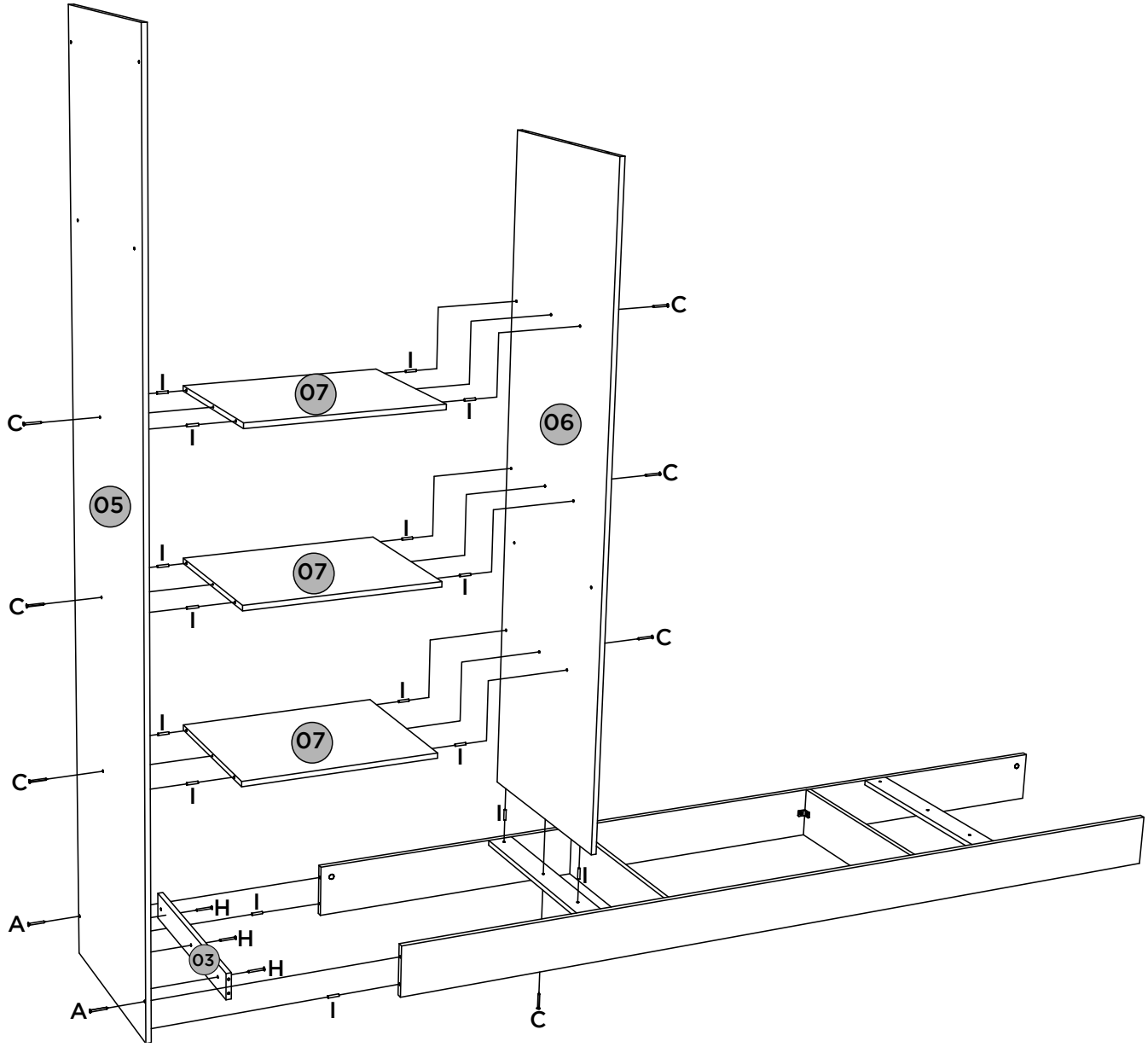

3

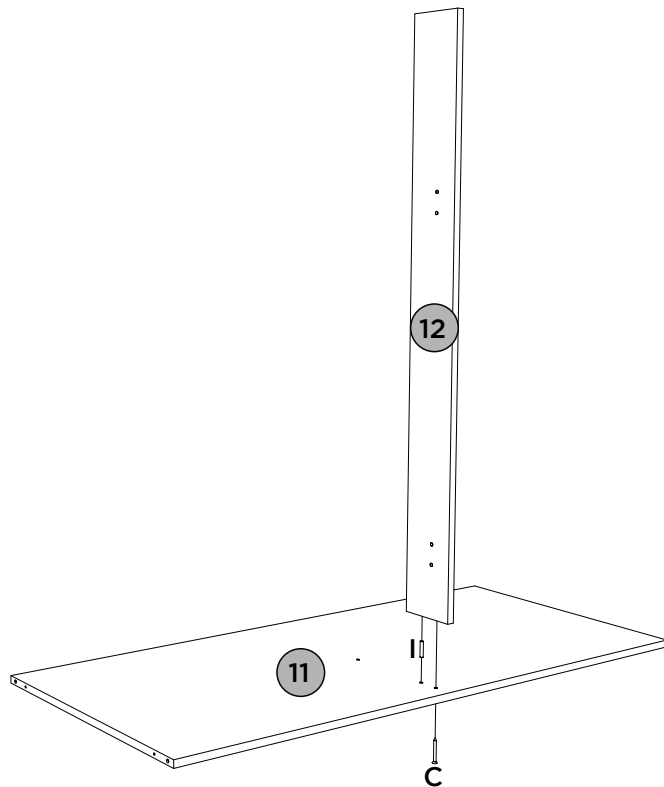

4

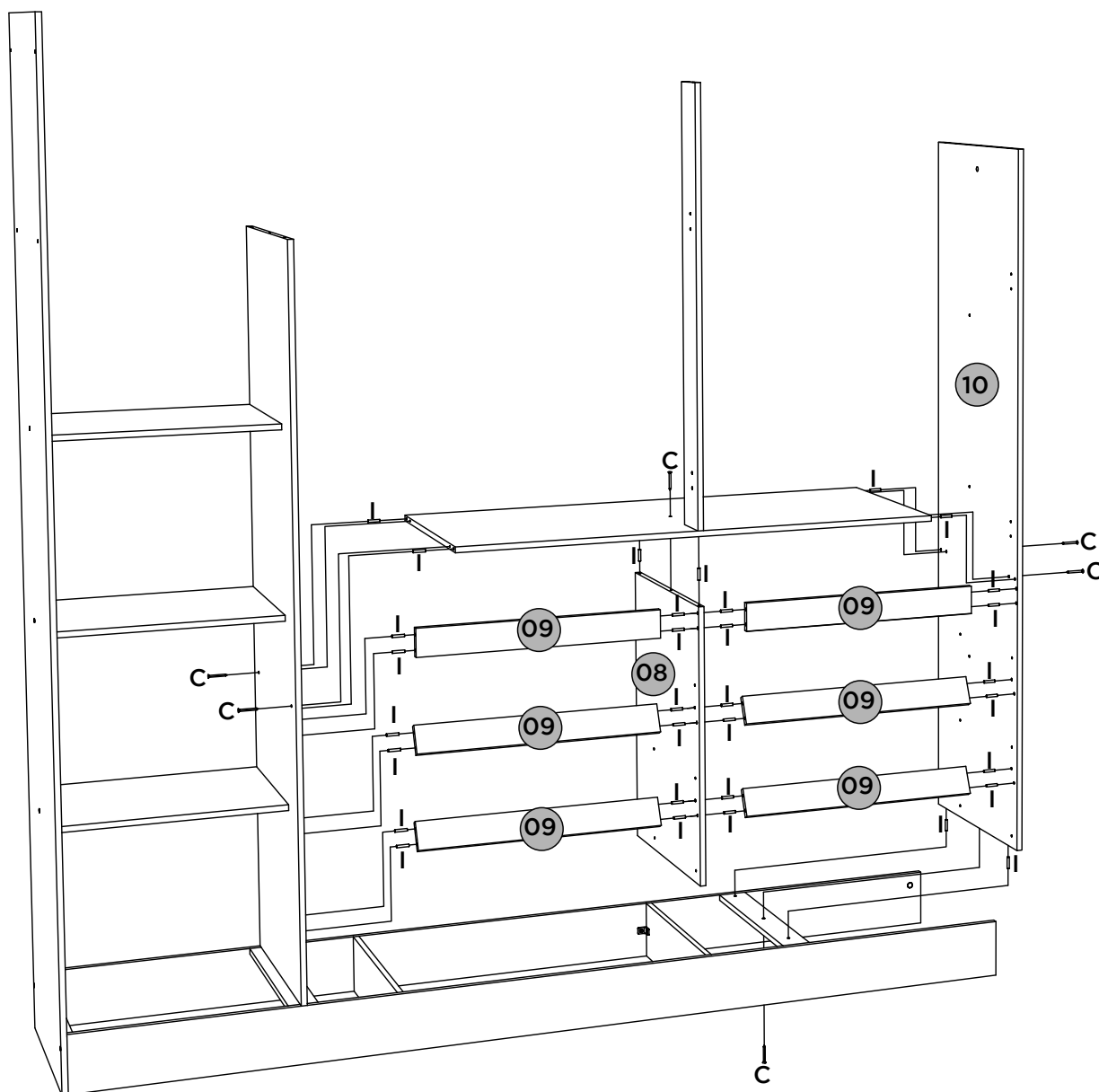

5

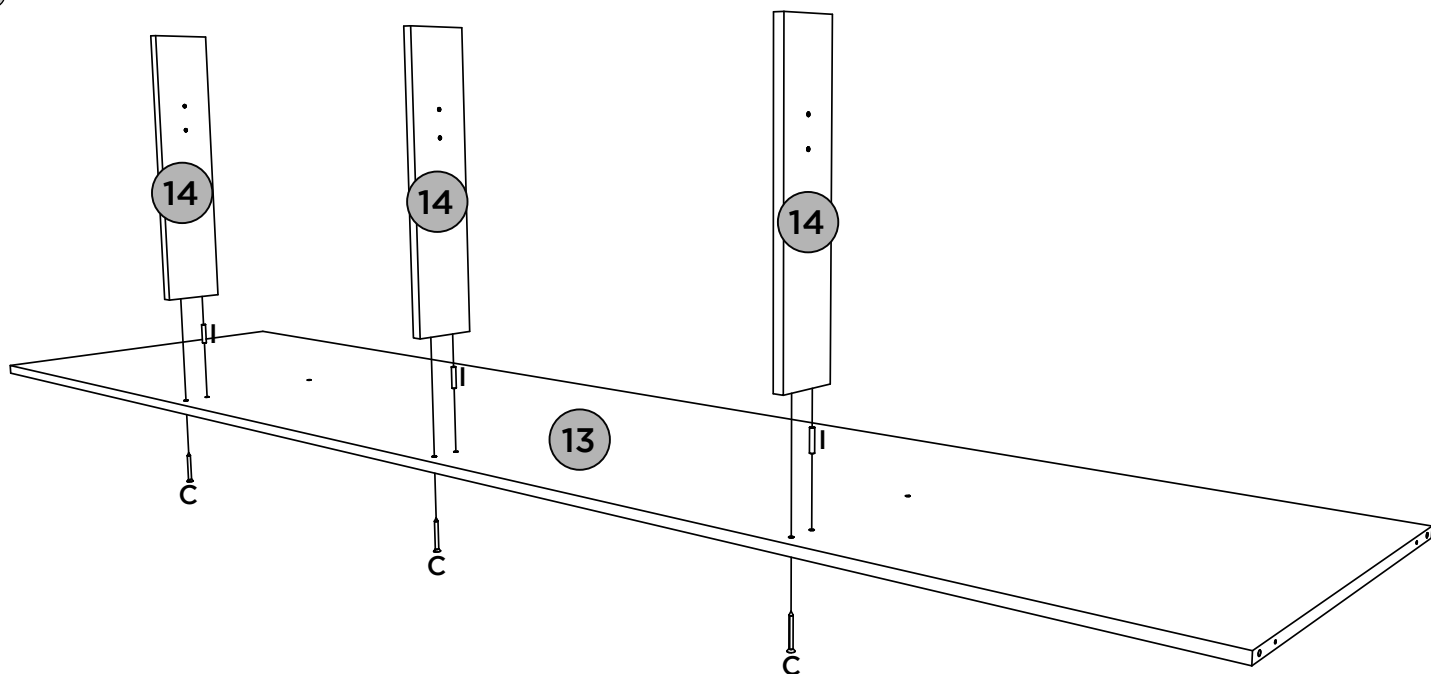

6

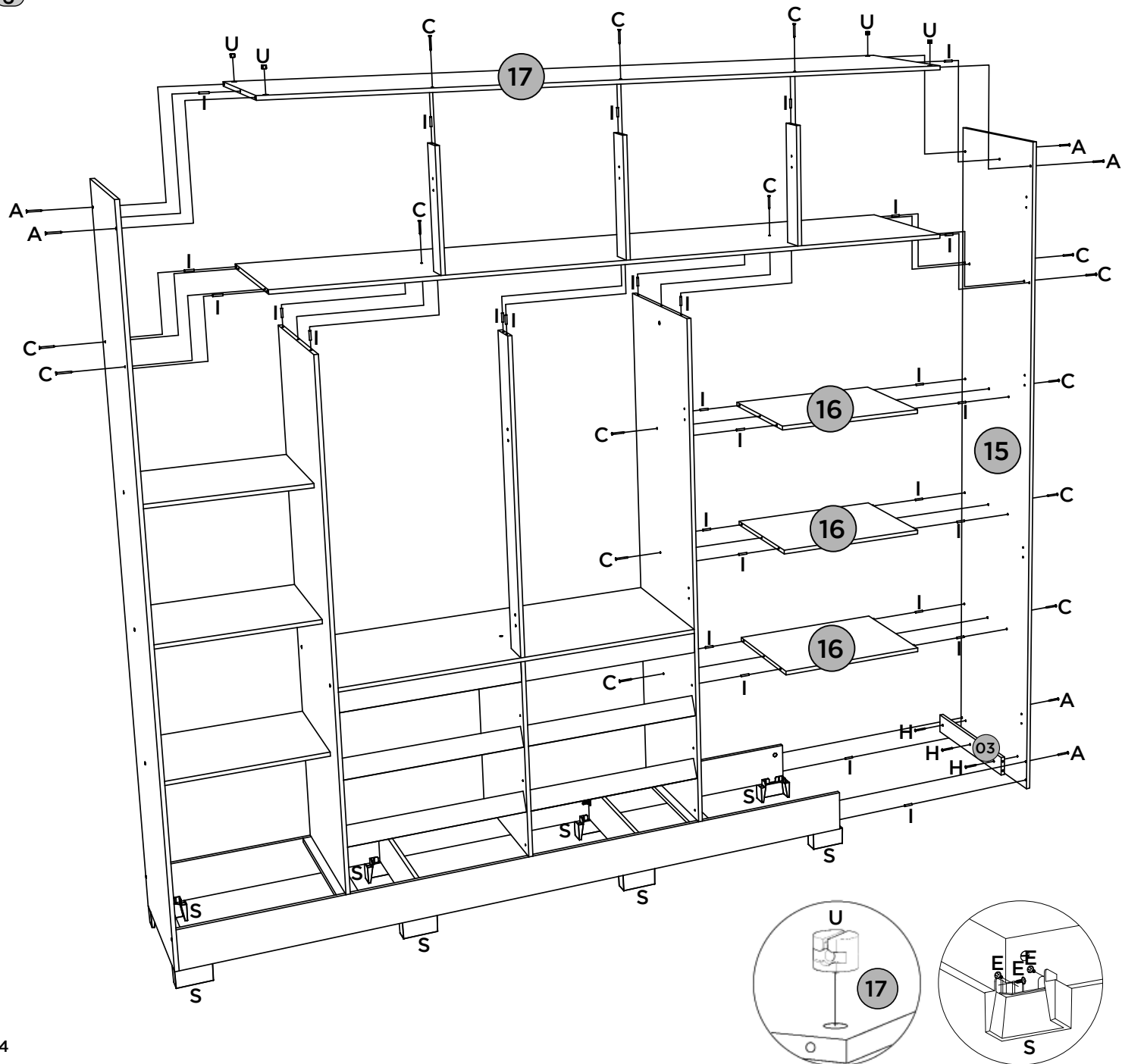

7

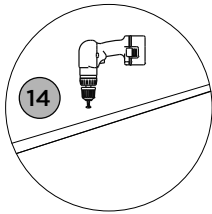
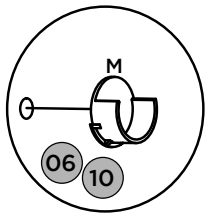

Fazer furação passante (broca de 5mm) para calço (O) na ripa do maleiro (central).

Fazer furação passante (broca de 5 mm) para calço (O) en la lama del maletero (central).

Drill a through hole (5 mm drill) for the shim (O) in the trunk slat (middle).

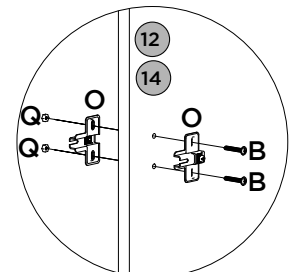
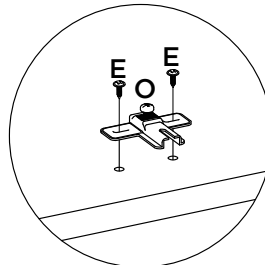
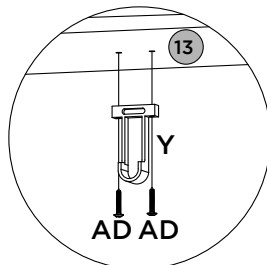
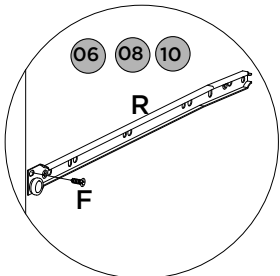
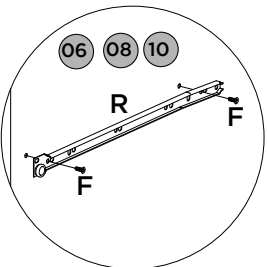
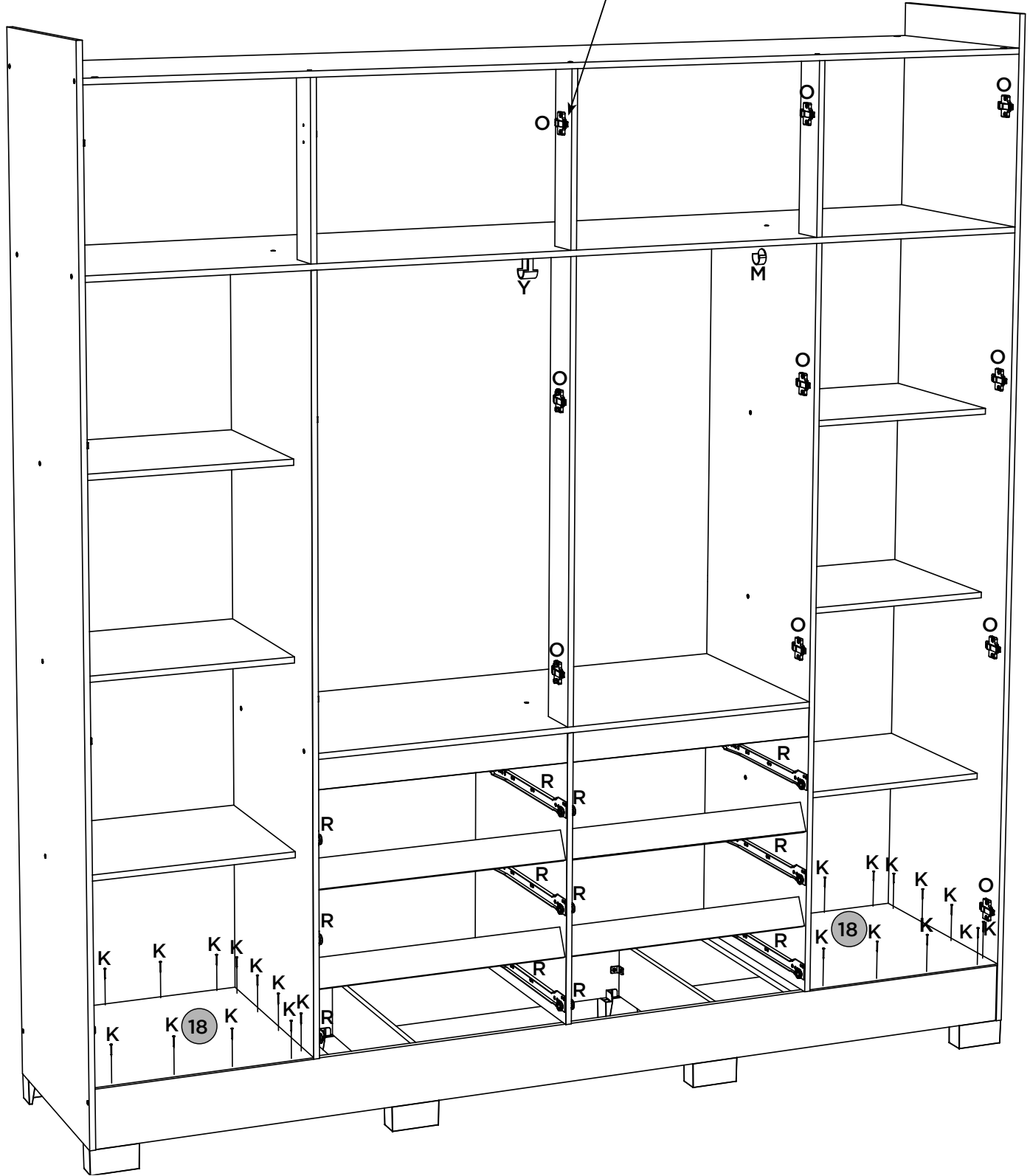

8

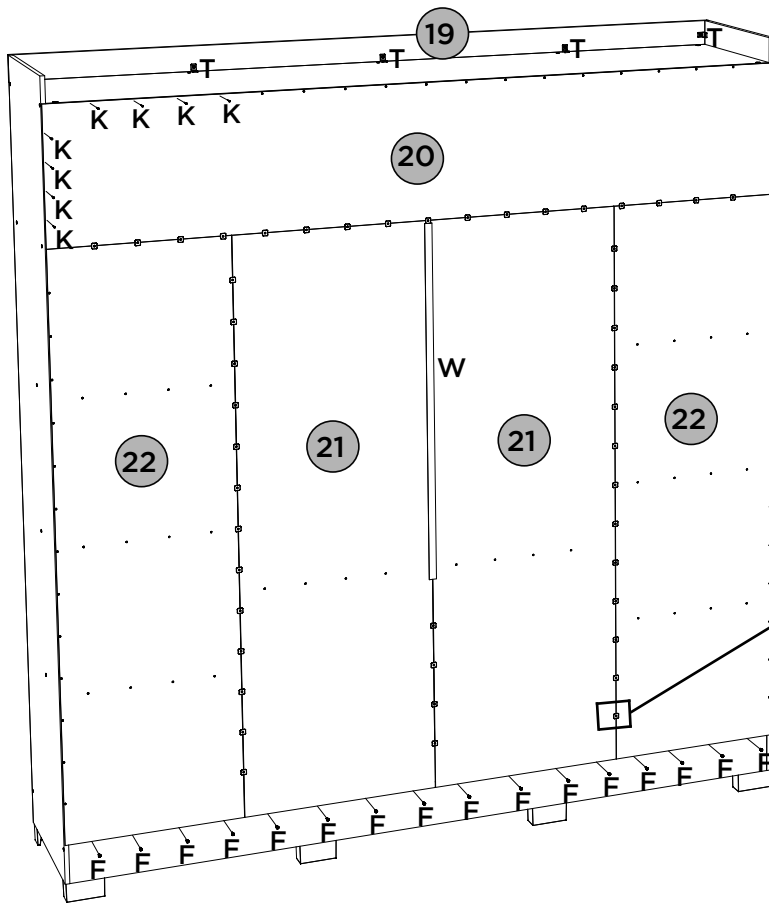

Fixar os pregos a uma distância de 120mm de um para outro.

Fijar las uñas a un distancia de 120 mm uno a otro.

Fix the nails at a distance of 120mm from one to the other

9

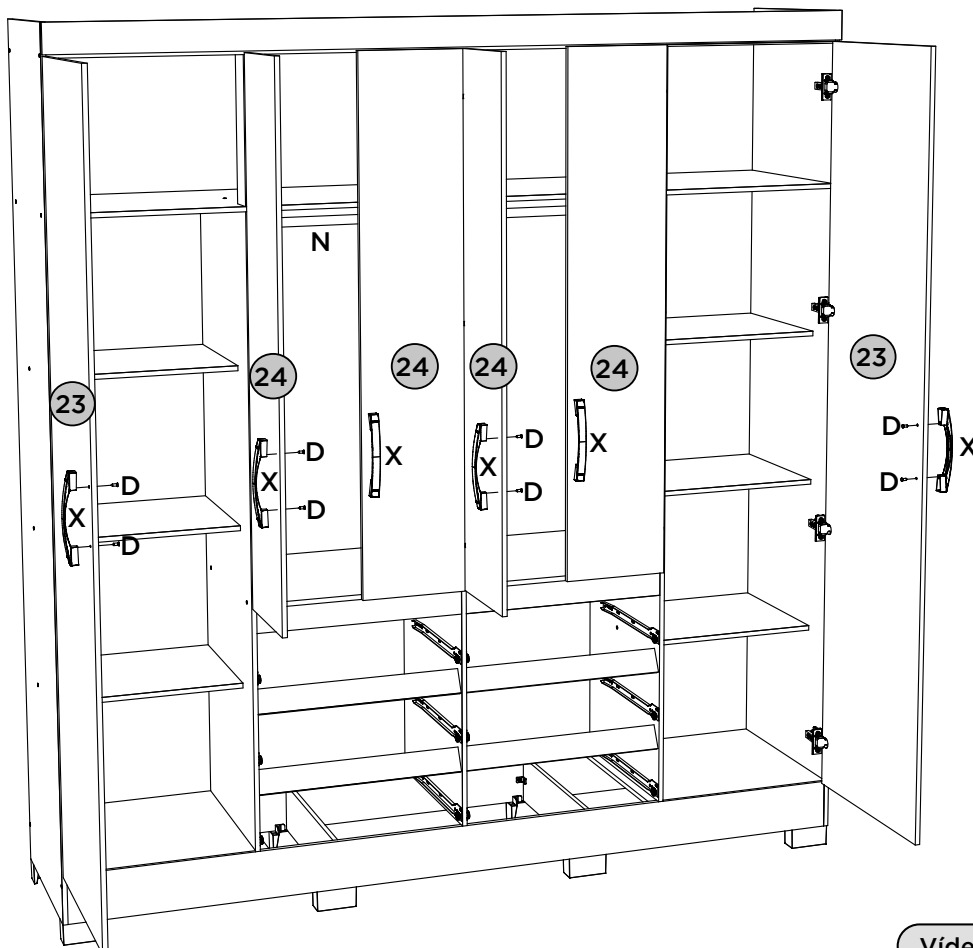

Vídeo: Instalar e regular Dobradiças

Video: Instale y ajuste las bisagras

Video: Install and adjust hinges

10

6x

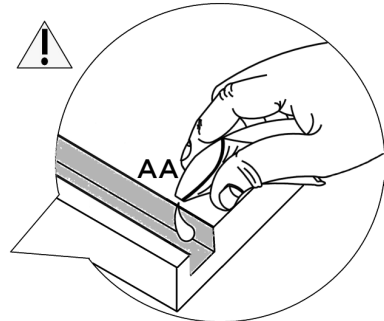
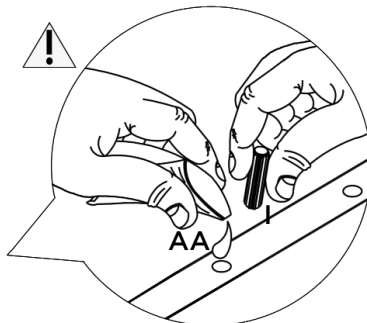
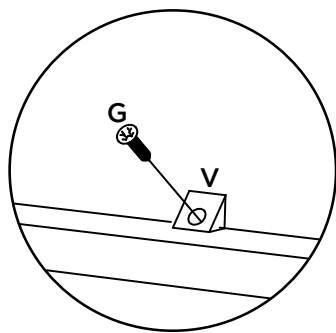
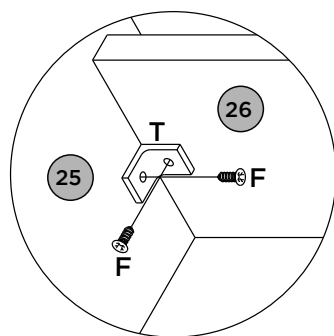
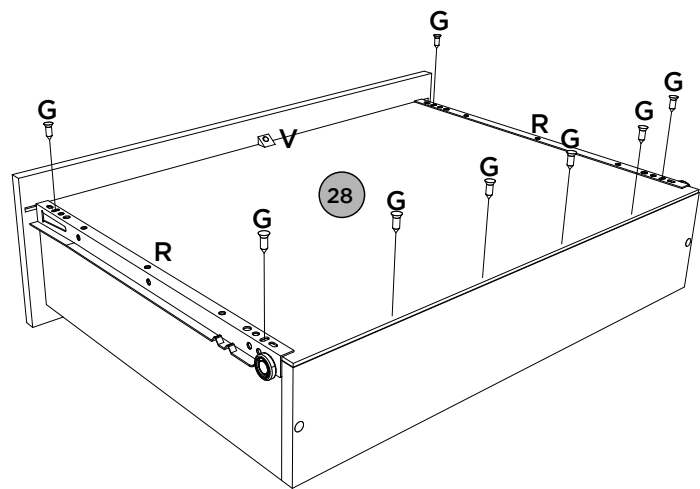
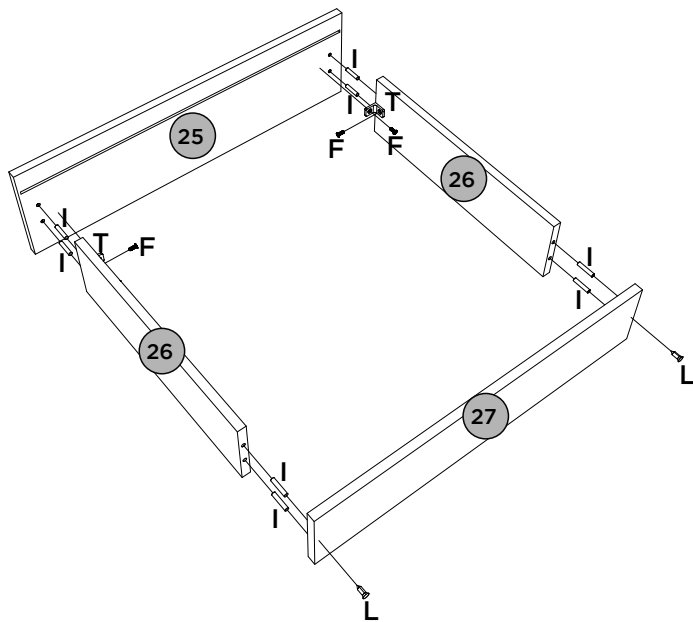



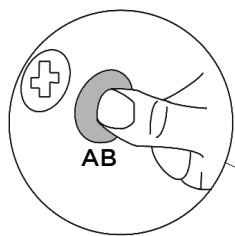









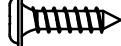



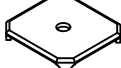
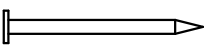

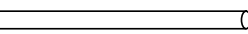
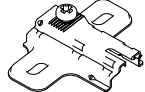
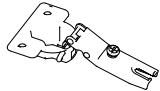
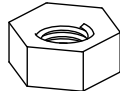

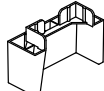
11

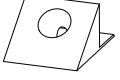
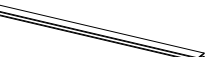
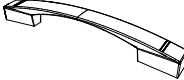

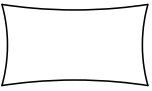
Item	Caixa Caja Box	Qtd Ctd Qty	Descrição   Descripción   Description	Medidas (mm)   Dimensions (mm)   Size (measurements) (mm)
01	2/3	01	Rodapé frontal   Rodapié frontal   Front footboards	1974x120x12
02	2/3	02	Travessa Rodapé   Rodapié Bandeja   Footboard Platter	420x120x12
03	2/3	04	Travessa   Bandeja   Platter	60x420x12
04	2/3	01	Rodapé traseiro   Rodapié trasero   Rear footboard	1974x120x12
05	2/3	01	Lateral esquerda   Lateral izquierda   Left side	2100x445x12
06	1/3	01	Divisão esquerda   División izquierda   Left division	1537x445x12
07=16	1/3	03	Prateleira   Estante   Shelf	455x350x12
08	2/3	01	Divisão Menor   División menor   Minor Division	594x445x12
09	2/3	06	Travessa Frontal   Travesaño delantero   Front cross member	60x514x12
10	1/3	01	Divisão direita   División derecha   Right division	1537x445x12
11	1/3	01	Tampo das gavetas   Tapa del cajón   Drawer top	1040x445x12
12	2/3	01	Pilastra Porta   Pilar de la puerta   Door Pillar	931x90x12
13	1/3	01	Chão do maleiro   piso del baúl   Floor of the closet top shelf	1974x445x12
14	2/3	03	Ripa do Maleiro   Listón maleiro   Maleiro slat	350x73x12
15	2/3	01	Lateral direita   Lateral derecha   Right side	2100x445x12
16=07	1/3	03	Prateleira   Estante   Shelf	455x350x12
17	1/3	01	Tampo   Cubrir   Cover	1974x445x12
18	3/3	02	Base 3mm   Base 3mm   Base 3mm	455x445x3
19	2/3	01	Chapéu   Sombrero   Hat	1996x73x12
20	2/3	01	Fundo Superior   Fondo Superior   Upper Fund	366x1994x3
21	3/3	02	Fundo   Fondo   Background	1558x525x3
22	3/3	02	Fundo Lateral   Fondo Lateral   Side background	1558x470x3
23	2/3	02	Porta   Puerta   Door	1909x465x12
24	3/3	04	Porta Central   Puerta Central   Cental Door	1310x260x12
25	1/3	06	Frente de Gaveta   Frente del Cajón   Drawer Front	522x152x12
26	1/3	12	Lado de gaveta   Lado del cajón   Drawer side	350x100x12
27	1/3	06	Ripa de trás   Listón trasero   Rear batten	489x100x12
28	3/3	06	Fundo de Gaveta   Fondo de cajón   Drawer Background	488x367x3

FERRAGENS | HERRAJES | HARDWARE

<b>A</b>  Parafuso 4,5x50mm CHT. Tornillo 4,5x50mm CHT. Screw 4,5x50mm CHT.	<b>B</b>  Parafuso 4,0x22mm MET. FLA. Tornillo 4,0x22mm MET.FLA. Screw 4,0x22mm MET. FLA.	<b>C</b>  Parafuso 3,5x40mm CHT. Tornillo 3,5x40mm CHT. Screw 3,5x40mm CHT.	<b>D</b>  Parafuso 3,5x25mm FLA. Tornillo 3,5x25mm FLA. Screw 3,5x25mm FLA.	<b>E</b>  Parafuso 3,5x12mm FLA. Tornillo 3,5x12mm FLA. Screw 3,5x12mm FLA.
<b>F</b>  Parafuso 3,5x12mm CHT. Tornillo 3,5x12mm CHT. Screw 3,5x12mm CHT.	<b>G</b>  Parafuso 3,0x16mm CHT. Tornillo 3,0x16mm CHT. Screw 3,0x16mm CHT.	<b>H</b>  Parafuso 3,0x20mm CHT. Tornillo 3,0x20mm CHT. Screw 3,0x20mm CHT.	<b>I</b>  Cavilha 5x25mm Cinta 5x25mm Dowel 5x25mm	<b>J</b>  Fixador de fundos Fijador de fondos Bottom fixer
<b>K</b>  Prego 10x10mm Clavo 10x10mm Nail 10x10mm	<b>L</b>  Prego 12x12mm Anelado Clavo 12x12mm Anillado Ringed Nails 12x12mm	<b>M</b>  Suporte cabideiro Soporte de percha Coat hanger support	<b>N</b>  Cabideiro Madeira 1034mm Cabezal Madera 1034mm 1034mm wooden hanger	<b>O</b>  Calço metal 5mm Calzado metálico 5mm 5mm metal shim
<b>P</b>  Dobradiça metal 26 mm Bisagra de metal 26 mm 26 mm metal hinge	<b>Q</b>  Porca sextavada Tuerca hexagonal Hexagon nuts	<b>R</b>  Corrediça metal 350mm Corredera metal 350mm Sliding metal 350mm	<b>S</b>  Pé "U" 50x40x100mm Pie "U" 50x40x100mm 50x40x100mm "U" feet	<b>T</b>  Cantoneira plástica Cantonera plástica Plastic angle brackets
<b>U</b>  Porca cilíndrica Tuerca cilíndrica Cylindrical nut	<b>V</b>  Cantoneira suporte triangular Cantonera soporte triangula Triangular support bracket	<b>W</b>  Perfil "I" 953mm Perfil "I" 953mm Profile "I" 953mm	<b>X</b>  Puxador Indonésia Tirador Indonésia Indonesia handle	<b>Y</b>  Suporte cabideiro "U" aberto. Soporte bote en "U" abierto. Open "U" canister support.
<b>Z</b>  Distanciador para Caneca de Dobradiça 26mm. Espaciador para Bisagra Taza 26mm. Spacer for Hinge Mug 26mm.	<b>AA</b>  Sachê de Cola Bolsa de pegamento Glue bag	<b>AB</b>  Adesivo tapa parafuso 10mm Adhesivo tapón de tornillo 10mm Bolt cover adhesive 10mm	<b>AC</b>  Etiqueta resinada Briz Etiqueta resinada Briz Briz resin label	<b>AD</b>  Parafuso 3,0x20mm FLA. Tornillo 3,0x20mm FLA. Screw 3,0x20mm FLA.



## KIT ESPELHO 1200x200x3 COM 2 UNIDADE

c B954-64 - Prata

Item	Caixa	Qtd	Descrição	Medidas (mm)
01	1/1	02	Espelho	1200x200x3

**Exemplo: Porta Central**  
1310x260x12  
(B355-130/198  
Roupeiro 06 Portas)

### Ferragens

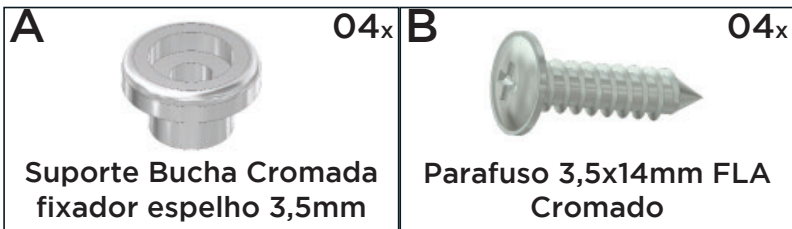

#### AVISO

Para limpeza de seu móvel, use uma flanela seca ou umedecida, e não utilize produtos químicos que possam danificar seu produto.

#### SISTEMA DE MONTAGEM

O sistema de montagem dos produtos, funciona de acordo com a ordem crescente dos números indicados no desenho. Ex: 01, 02, 03, 04... até a conclusão da montagem.

**Medidas em mm**

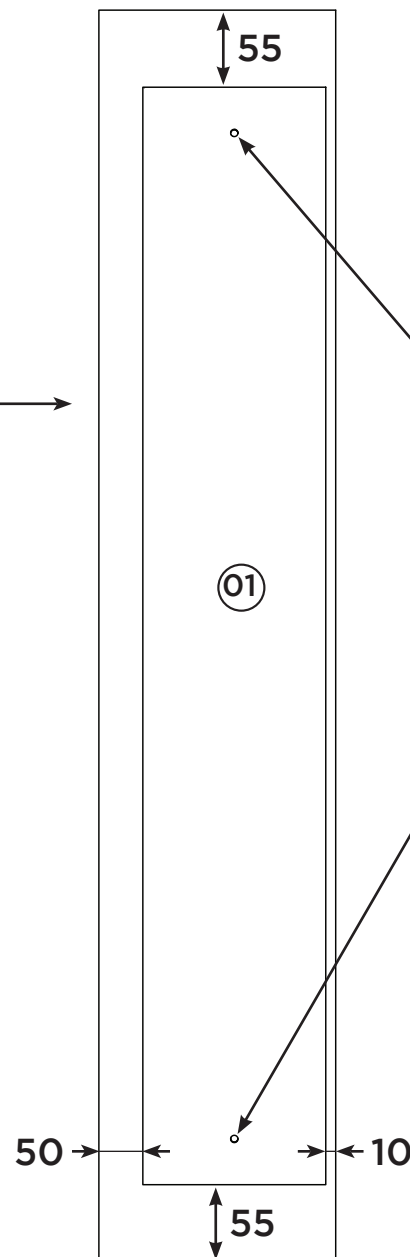

Fixar o Espelho com a Bucha (A) e o Parafuso (B)  
Utilizar a parafusadeira com o torque 3.

#### Requisitos para montagem

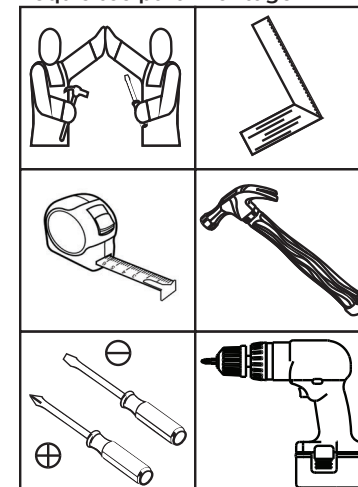

Imagens meramente ilustrativas