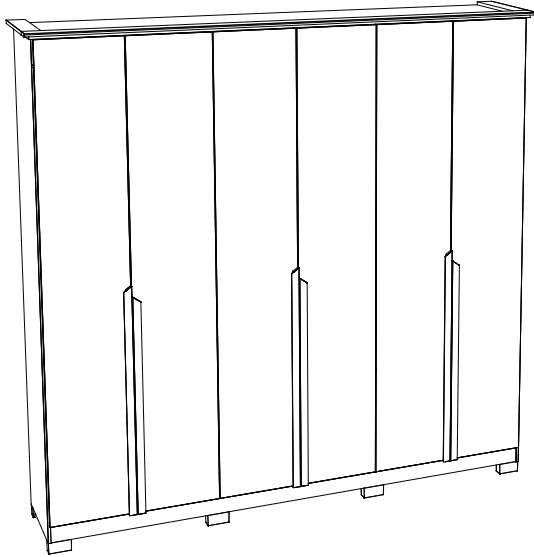
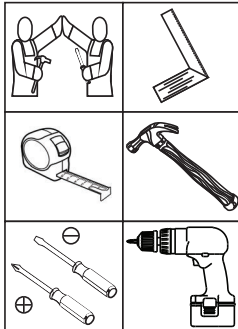

**HENN**Ind. e Com. de Móveis Henn  
Mondai - SC - Brasil

☎ +55 49 3674.3500

📷 📱 @moveishenn  
www.henn.com.br**INSTRUÇÕES DE  
MONTAGEM**INSTRUCCIONES DE MONTAJE  
ASSEMBLY INSTRUCTIONS**Roupeiro Andréas 6 Portas 6 Gavetas | Armario Andréas 6 Puertas 6 Cajones |  
Wardrobe Andréas 6 Doors 6 Drawers****D309-127 Nature/Off White  
D309-169 Cinza/Nature****Requisitos para montagem  
Requisitos para la montaje  
Assembly Requirements**

Imagens meramente ilustrativas,  
não acompanha o produto.  
Imágenes ilustrativas, no incluidas  
con el producto.  
Illustrative images, not included  
with the product.

**AVISO**

Para limpeza de seu móvel, use uma flanela seca ou umedecida, e não utilize produtos químicos que possam danificar seu produto.

**SISTEMA DE MONTAGEM**

O sistema de montagem dos produtos, funciona de acordo com a ordem crescente dos números indicados no desenho. Ex: 01, 02, 03, 04... até a conclusão da montagem.

**ASSISTÊNCIA TÉCNICA**

Para solicitação de Assistência Técnica você consumidor deverá entrar em contato com o Lojista a qual você realizou a compra deste produto e solicitar a assistência técnica das peças avariadas. A garantia abrange todas as peças, partes e componentes que eventualmente venham apresentar defeito de fabricação no prazo de 03 (três) meses, contando a partir da entrega do produto ao consumidor, mediante nota fiscal de compra. Se houver qualquer alteração na estrutura do produto ou ocorrer defeito por negligência do montador/consumidor em relação a instrução de montagem e manuseio, não será fornecido assistência técnica gratuita.

**ADVERTENCIA**

Para limpeza de su móvil, use una flanela seca o húmeda, y no utilice productos químicos que puedan dañar su producto.

**SISTEMA DE MONTAJE**

El sistema de montaje de los productos funciona de acuerdo con el orden creciente de los números indicados en el dibujo. Ej.: 01, 02, 03, 04... hasta la conclusión del montaje.

**ASISTENCIA TÉCNICA**

Para solicitar Asistencia Técnica, el consumidor debe comunicarse con el Comercio que usted realizó la compra de este producto y solicita asistencia técnica para las partes dañadas. La garantía cubre todas las partes, piezas y componentes que eventualmente puedan presentar defecto de fabricación en el plazo de 03 (tres) meses, contados a partir de la entrega del producto al consumidor, mediante factura de compra. Si se produce algún cambio en la estructura del producto o se produce un defecto por negligencia del montador/consumidor en relación con las instrucciones de montaje y manipulación, no se prestará asistencia técnica gratuita.

**NOTICE**

To clean your furniture, use a dry or wet cloth, and do not use chemicals that may damage your product.

**ASSEMBLY SYSTEM**

The products' assembly system works according to the increasing order of the indicated numbers. For example: 01, 02, 03, 04 ... to the end of the assembly.

**TECHNICAL ASSISTANCE**

To request Technical Assistance, the consumer must contact the retailer from whom you purchased this product and request technical assistance for the damaged parts. The warranty covers all parts, parts and components that may eventually present a manufacturing defect within a period of 03 (three) months, counting from the delivery of the product to the consumer, by means of a purchase invoice. If there is any change in the structure of the product or defect occurs due to negligence of the assembler/consumer in relation to the assembly and handling instruction, free technical assistance will not be provided.

ACESSÓRIOS | ACCESORIOS | ACCESSORIES

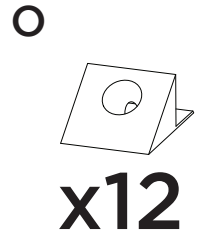
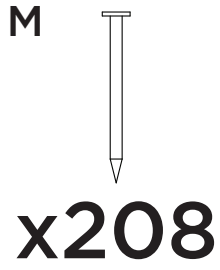
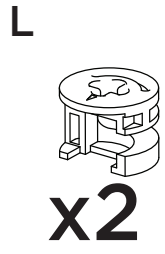
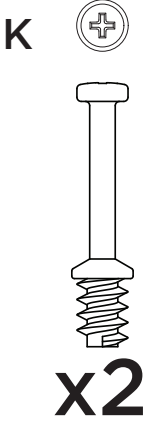
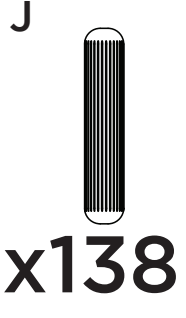
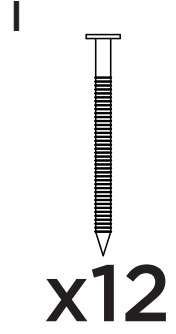
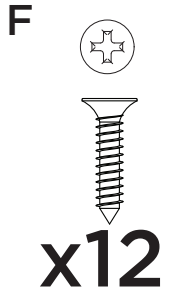
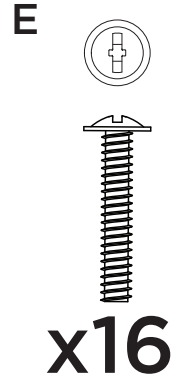
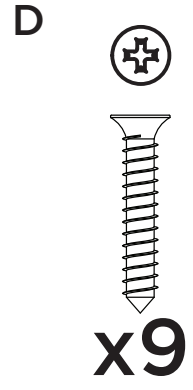
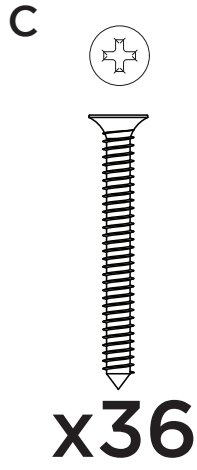
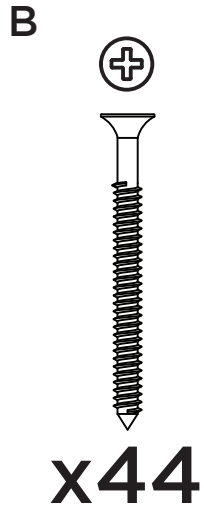
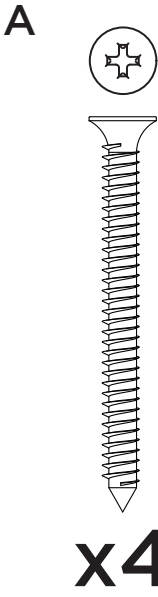

Parafusos em escala  
Tornillos escalados  
Scaled screws **1:1**

## ACESSÓRIOS | ACCESORIOS | ACCESSORIES

P

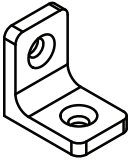

x22

Q



x4

R



x16

S

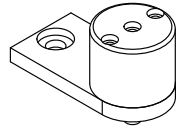

x12

T

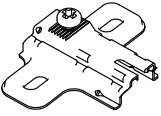

x24

U

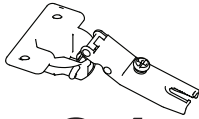

x24

V

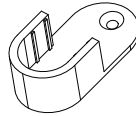

x4

W

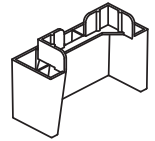

x8

X



x24

Y

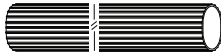

x2

Z



x6 PAR

AA



x3

AB

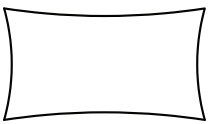

x3

AC

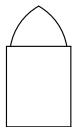

x3

AD

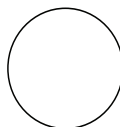

x4

AE



x42

# LISTA DE PEÇAS | LISTA DE PIEZAS | LIST OF PIECES ITM/D309-

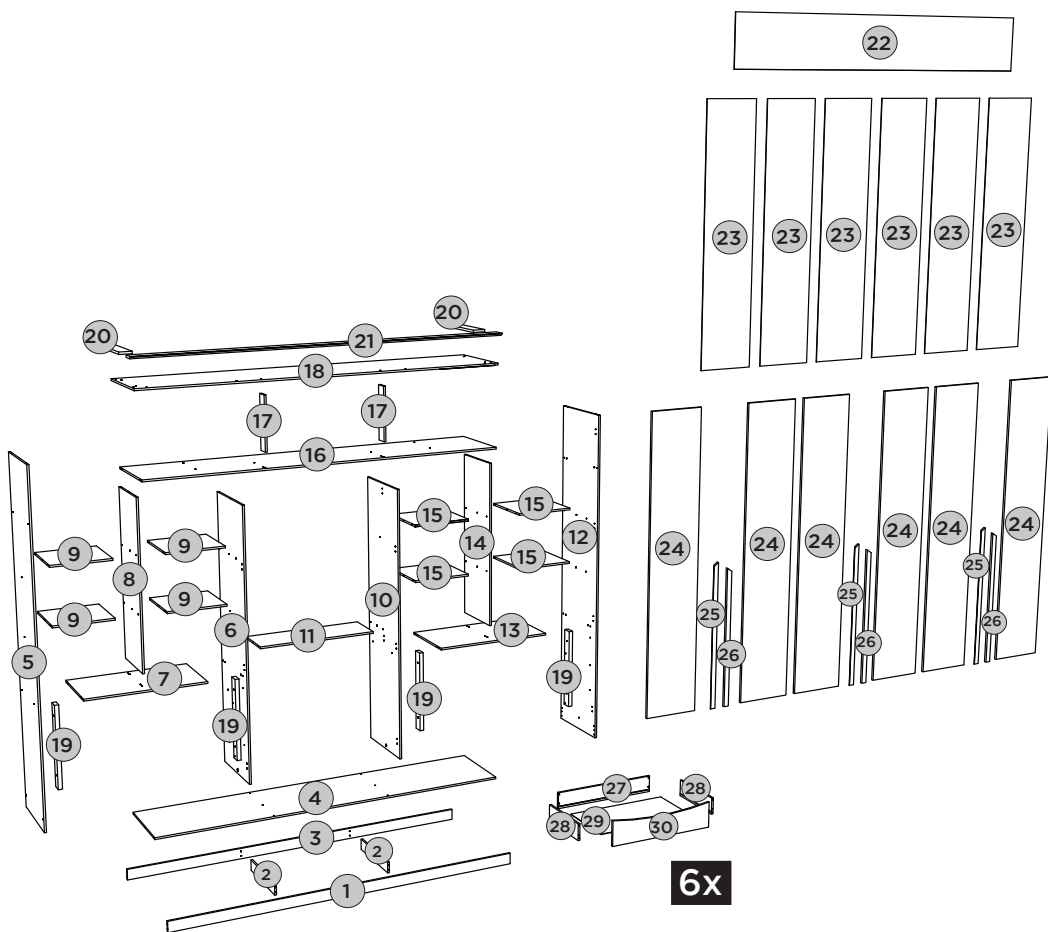

| 26Item27 | Caixa<br>Caja<br>Box | Qty<br>Ctd<br>Qty | Descrição<br>Descripción<br>Description  | Dimensões (mm)   Dimensiones (mm)  <br>Dimensions (mm) |                           |                                  |
|----------|----------------------|-------------------|--|--|---------------------------|----------------------------------|
|          |                      |                   |  | Comprimento<br>Largo<br>Length                         | Largura<br>Ancho<br>Width | Espessura<br>Grosor<br>Thickness |
| 1        | 2/4                  | 1                 | RODAPÉ FRONTAL   FALDÓN DELANTERO   FRONT SKIRTING                             | 2265   | 73                        | 12                               |
| 2        | 2/4                  | 2                 | TRAVESSA DO RODAPÉ   PLACA DE RODAPIÉ   SKIRTING PLATE                         | 415  | 73                        | 12                               |
| 3        | 2/4                  | 1                 | RODAPÉ TRASEIRO   REPOSAPIÉS TRASERO   BACK FOOTBOARD                          | 2265   | 73                        | 12                               |
| 4        | 2/4                  | 1                 | BASE   BASE   BASE   | 2265   | 445                       | 12                               |
| 5        | 3/4                  | 1                 | LATERAL ESQUERDA   LATERAL IZQUIERDA   LEFT SIDE                               | 2223   | 445                       | 12                               |
| 6        | 1/4                  | 1                 | DIVISÃO ESQUERDA   DIVISIÓN IZQUIERDA   LEFT DIVISION                          | 1776   | 445                       | 12                               |
| 7=13     | 1/4                  | 1                 | TAMPO DAS GAVETAS   TAPA DE LOS CAJONES   TOP OF DRAWERS                       | 747  | 400                       | 12                               |
| 8=14     | 3/4                  | 1                 | DIVISÃO NICHU   DIVISIÓN NICHU   NICHE DIVISION                                | 1089   | 351                       | 12                               |
| 9=15     | 3/4                  | 4                 | PRATELEIRA   ESTANTE   SHELF   | 367  | 350                       | 12                               |
| 10       | 1/4                  | 1                 | DIVISÃO DIREITA   DIVISIÓN DERECHA   RIGHT DIVISION                            | 1776   | 445                       | 12                               |
| 11       | 1/4                  | 1                 | PRATELEIRA DO CALCEIRO   ESTANTE DE CALCEIRO   CALCEIRO'S SHELF                | 747  | 250                       | 12                               |
| 12       | 3/4                  | 1                 | LATERAL DIREITA   LADO DERECHO   RIGHT SIDE                                    | 2223   | 445                       | 12                               |
| 13=7     | 1/4                  | 1                 | TAMPO DAS GAVETAS   TAPA DE LOS CAJONES   TOP OF DRAWERS                       | 747  | 400                       | 12                               |
| 14=8     | 3/4                  | 1                 | DIVISÃO NICHU   DIVISIÓN NICHU   NICHE DIVISION                                | 1089   | 351                       | 12                               |
| 15=9     | 3/4                  | 4                 | PRATELEIRA   ESTANTE   SHELF   | 367  | 350                       | 12                               |
| 16       | 2/4                  | 1                 | CHÃO DO MALEIRO   REPISA SUPERIOR   FLOOR OF MALEIRO                           | 2265   | 445                       | 12                               |
| 17       | 3/4                  | 2                 | RIPA DO MALEIRO   TRAVESSAÑO SUPERIOR   MALEIRO'S LATH                         | 350  | 73                        | 12                               |
| 18       | 2/4                  | 1                 | TAMPO   TAPA   TOP   | 2309   | 465                       | 12                               |
| 19       | 3/4                  | 4                 | RIPA LATERAL   RIPA LATERAL   SIDE CLAPBOARD                                   | 525  | 58                        | 25                               |
| 20       | 2/4                  | 2                 | MOLDURA LATERAL   MARCO LATERAL   LATERAL FRAME                                | 401  | 80                        | 15                               |
| 21       | 2/4                  | 1                 | MOLDURA FRONTAL SUPERIOR   MARCO SUPERIOR DELANTERO   UPPER FRONT FRAME        | 2349   | 80                        | 15                               |
| 22       | 2/4                  | 1                 | FUNDO SUPERIOR   FONDO TOP   TOP FUND  | 2283   | 367                       | 3                                |
| 23       | 3/4 e<br>4/4         | 6                 | FUNDO   FONDO   BOTTOM   | 1793   | 377                       | 3                                |
| 24       | 4/4                  | 6                 | PORTA   PUERTA   DOOR  | 2141   | 377                       | 15                               |
| 25       | 2/4                  | 3                 | APLIQUE MAIOR   APLICARSE MÁS GRANDE   APPLY BIGGER                            | 1050   | 40                        | 15                               |
| 26       | 2/4                  | 3                 | APLIQUE MENOR   APLICAR MÁS PEQUEÑO   APPLY SMALLER                            | 1000   | 40                        | 15                               |
| 27       | 1/4                  | 6                 | RIPA DE TRÁS   MALLA DETRÁS   REAR LAHT  | 677  | 110                       | 12                               |
| 28       | 3/4                  | 12                | LADO DE GAVETA   LADO DEL CAJÓN   SIDE OF DRAWER                               | 350  | 110                       | 12                               |
| 29       | 2/4                  | 6                 | FUNDO DE GAVETA RECORTADO   FONDO DE CAJÓN RECORTADO   RECORTADO DRAWER BOTTOM | 664  | 361                       | 3                                |
| 30       | 1/4                  | 6                 | FRENTE DE GAVETA   FRENTE DE CAJÓN   FRONT OF DRAWER                           | 689  | 170                       | 12                               |



## PEÇAS REQUERIDAS

|    |                    |    |
|----|--------------------|----|
| 1  | RODAPÉ FRONTAL     | x1 |
| 2  | TRAVESSA DO RODAPÉ | x2 |
| 3  | RODAPÉ TRASEIRO    | x1 |
| 17 | RIPA DO MALEIRO    | x2 |

## ACESSÓRIOS REQUERIDOS

|   |   |    |
|---|---|----|
| H |  | 04 |
| J |  | 20 |
| P |  | 04 |

## FERRAMENTAS NECESSÁRIAS

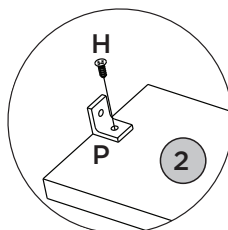
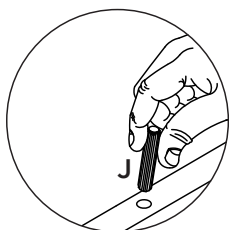
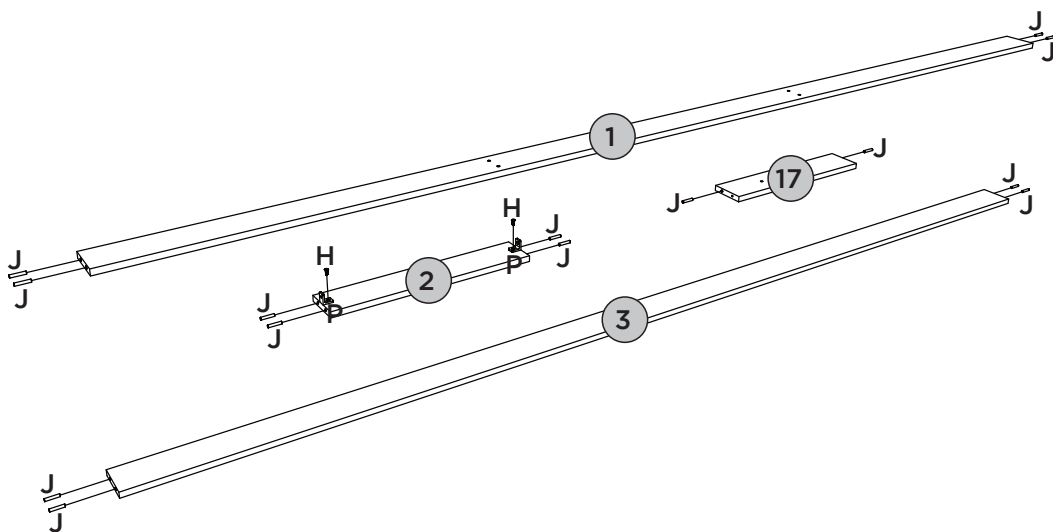
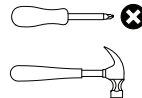

## PEÇAS REQUERIDAS

|   |                  |    |
|---|------------------|----|
| 4 | BASE             | x1 |
| 5 | LATERAL ESQUERDA | x1 |
| 6 | DIVISÃO ESQUERDA | x1 |

## ACESSÓRIOS REQUERIDOS

|   |  |    |
|---|--|----|
| H |  | 18 |
| J |  | 08 |
| K |  | 02 |
| Q |  | 04 |
| S |  | 06 |
| T |  | 04 |
| V |  | 02 |

## FERRAMENTAS NECESSÁRIAS

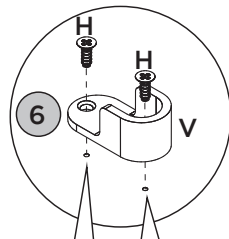
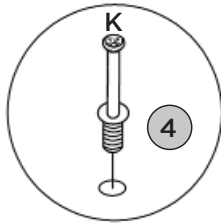
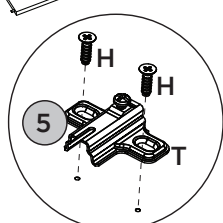
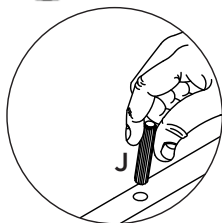
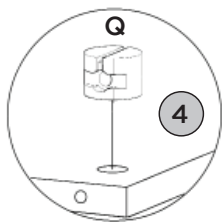
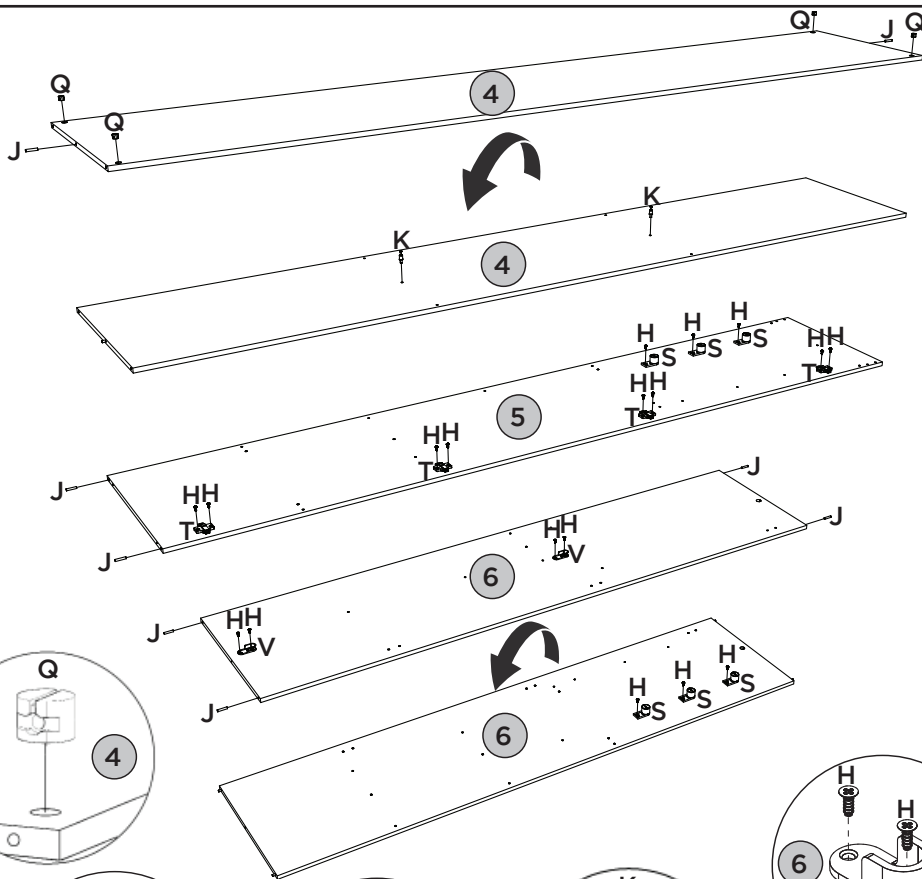
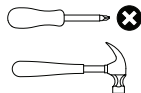

**Observe:  
Furos  
pré-marcados**

## PEÇAS REQUERIDAS

|      |                        |    |
|------|------------------------|----|
| 7=13 | TAMPO DAS GAVETAS      | x2 |
| 8=14 | DIVISÃO NICHOS         | x2 |
| 9=15 | PRATELEIRA             | x8 |
| 11   | PRATELEIRA DO CALCEIRO | x1 |

## ACESSÓRIOS REQUERIDOS

|   |   |    |
|---|---|----|
| J |  | 52 |
|---|---|----|

## FERRAMENTAS NECESSÁRIAS

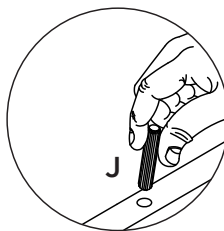
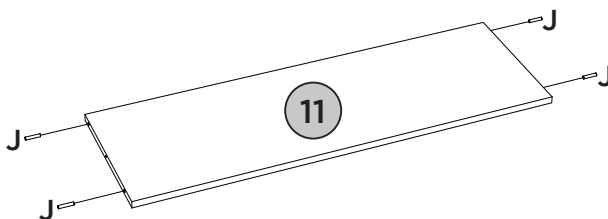
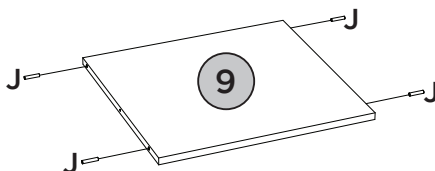
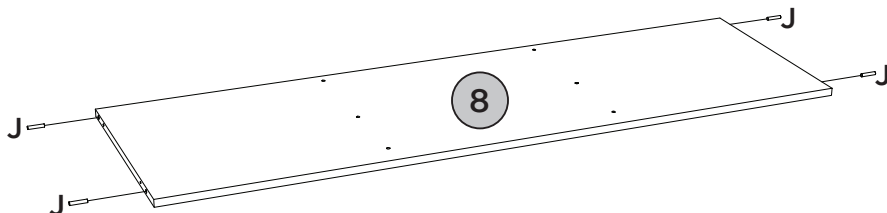
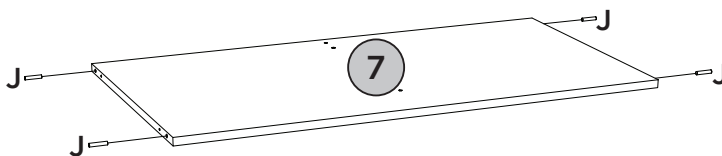
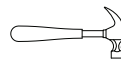







# PASSO 4

ITM/D309-

## PEÇAS REQUERIDAS

|    |                 |    |
|----|-----------------|----|
| 10 | DIVISÃO DIREITA | x1 |
| 12 | LATERAL DIREITA | x1 |
| 16 | CHÃO DO MALEIRO | x1 |

## ACESSÓRIOS REQUERIDOS

|   |   |    |
|---|---|----|
| H |   | 18 |
| J |  | 10 |
| S |  | 06 |
| T |  | 04 |
| V |  | 02 |

## FERRAMENTAS NECESSÁRIAS

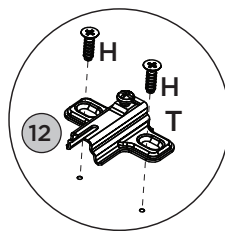
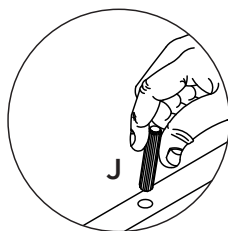
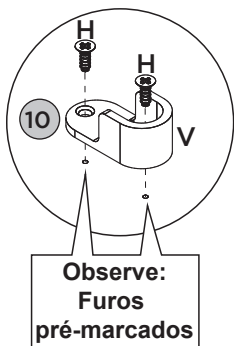
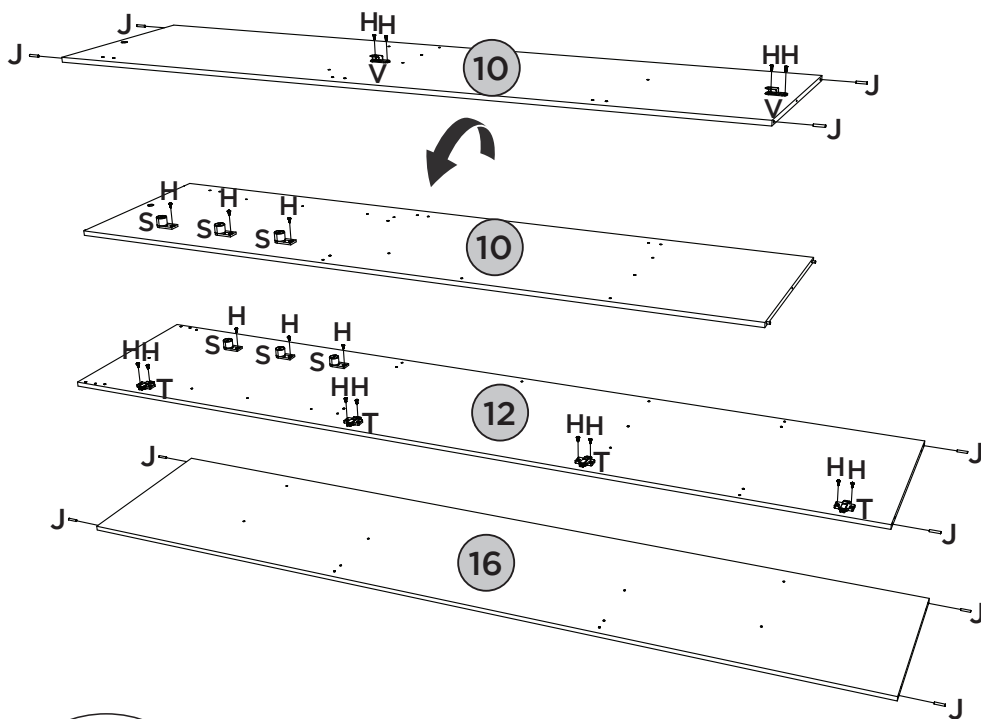
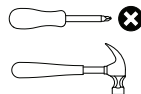

# PASSO 5

ITM/D309-

## PEÇAS REQUERIDAS

|   |                    |    |
|---|--------------------|----|
| 1 | RODAPÉ FRONTAL     | x1 |
| 2 | TRAVESSA DO RODAPÉ | x2 |
| 3 | RODAPÉ TRASEIRO    | x1 |

## ACESSÓRIOS REQUERIDOS



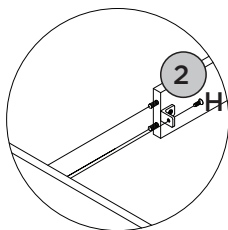
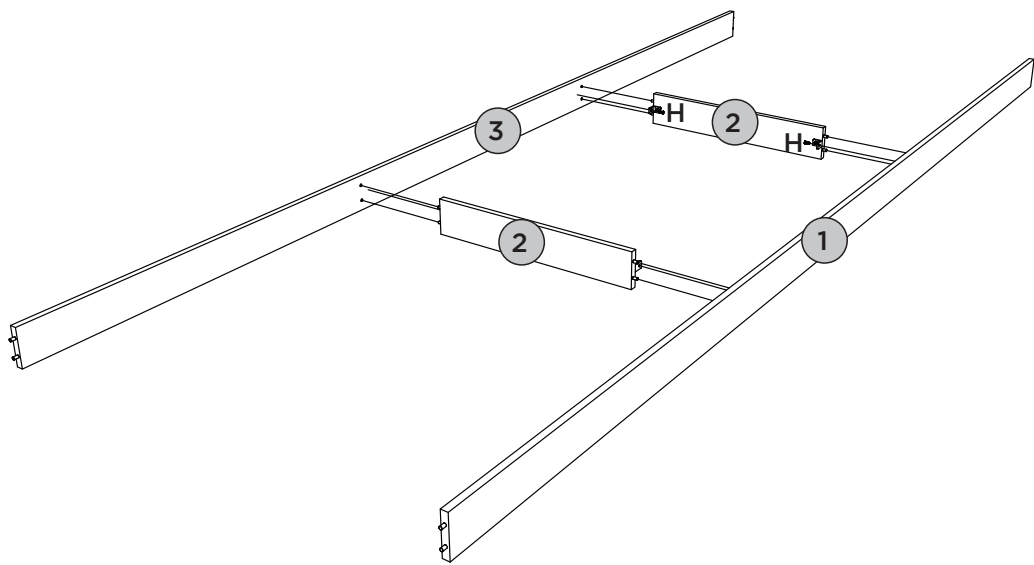
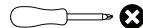

## FERRAMENTAS NECESSÁRIAS



## PEÇAS REQUERIDAS

|   |      |    |
|---|------|----|
| 4 | BASE | x1 |
|---|------|----|

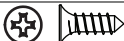
## ACESSÓRIOS REQUERIDOS

|   |   |    |
|---|---|----|
| H |   | 36 |
| P |  | 06 |
| W |  | 08 |

## FERRAMENTAS NECESSÁRIAS

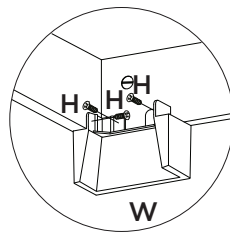
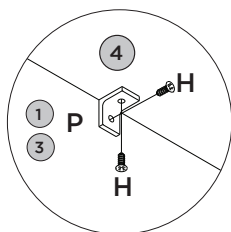
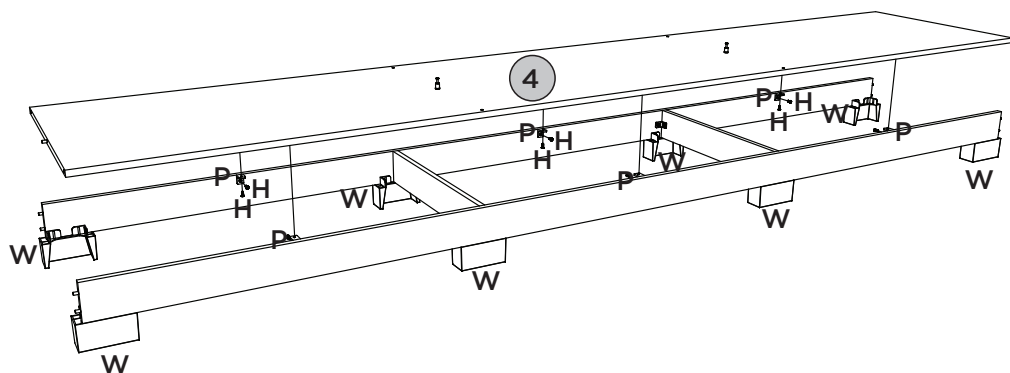
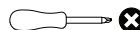

## PEÇAS REQUERIDAS

|   |                   |    |
|---|-------------------|----|
| 5 | LATERAL ESQUERDA  | x1 |
| 6 | DIVISÃO ESQUERDA  | x1 |
| 7 | TAMPO DAS GAVETAS | x1 |
| 8 | DIVISÃO NICHOS    | x1 |
| 9 | PRATELEIRA        | x4 |

## ACESSÓRIOS REQUERIDOS

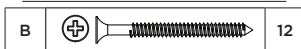

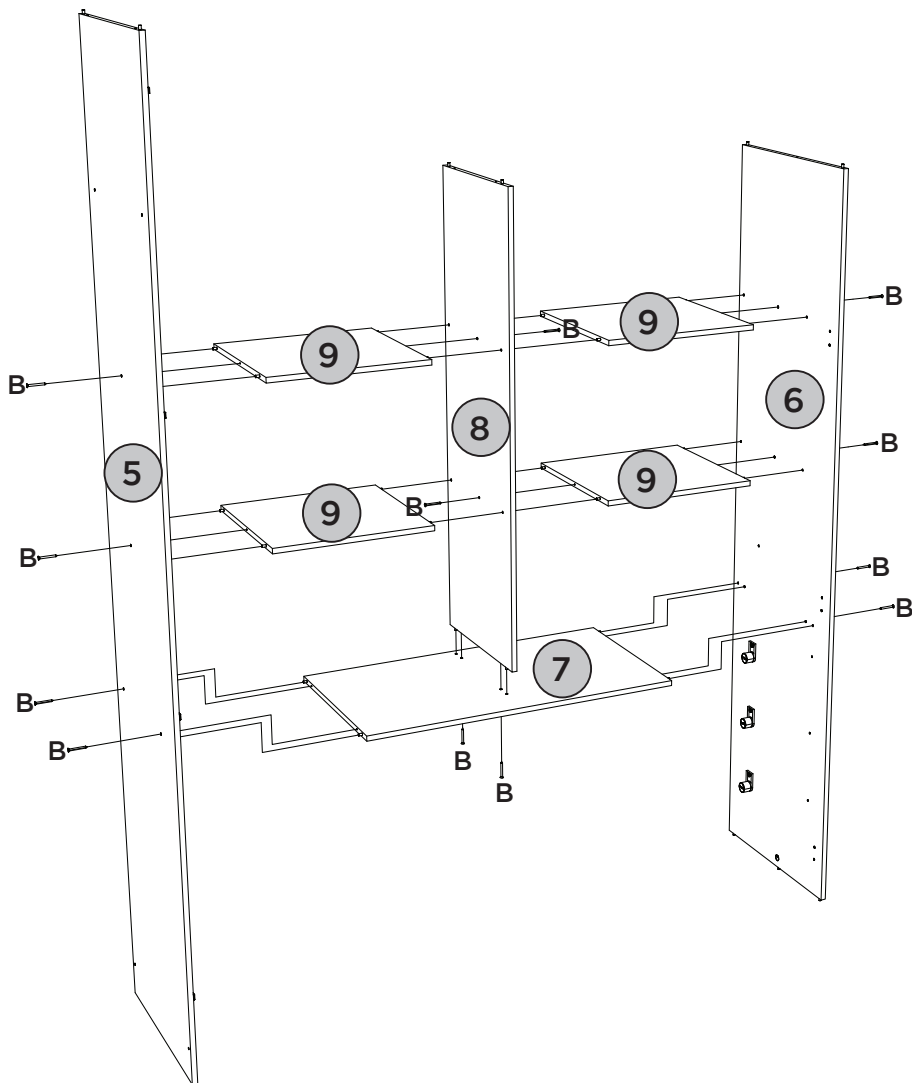
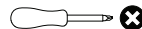

## FERRAMENTAS NECESSÁRIAS



## PEÇAS REQUERIDAS

|    |                        |    |
|----|------------------------|----|
| 10 | DIVISÃO DIREITA        | x1 |
| 11 | PRATELEIRA DO CALCEIRO | x1 |

## ACESSÓRIOS REQUERIDOS

|   |   |    |
|---|---|----|
| A |  | 02 |
| B |  | 02 |
| L |  | 02 |



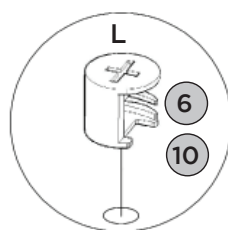
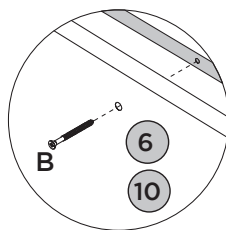
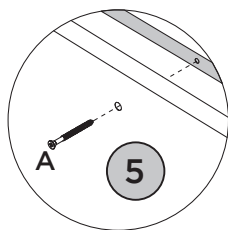
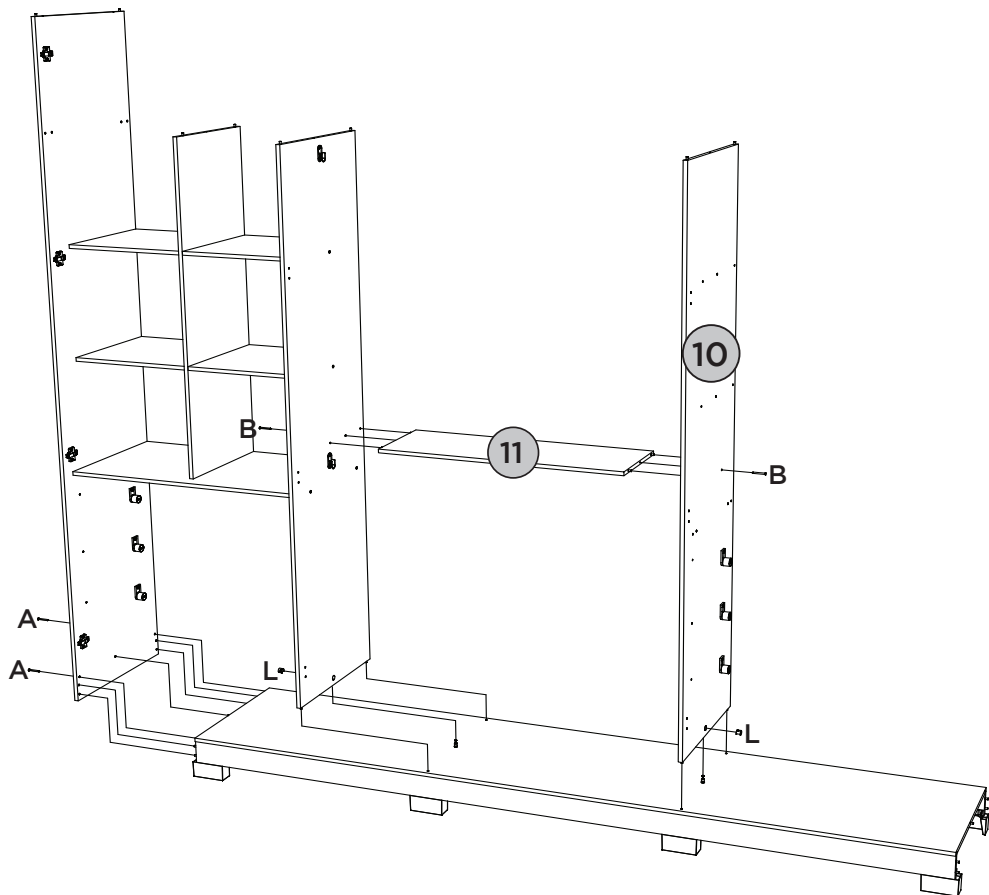
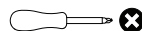

## FERRAMENTAS NECESSÁRIAS



## PEÇAS REQUERIDAS

|    |                   |    |
|----|-------------------|----|
| 12 | LATERAL DIREITA   | x1 |
| 13 | TAMPO DAS GAVETAS | x1 |
| 14 | DIVISÃO NICHOS    | x1 |
| 15 | PRATELEIRA        | x4 |
| 16 | CHÃO DO MALEIRO   | x1 |
| 17 | RIPA DO MALEIRO   | x2 |

## ACESSÓRIOS REQUERIDOS

|   |   |   |    |
|---|---|---|----|
| A |  |  | 02 |
| B |  |  | 24 |

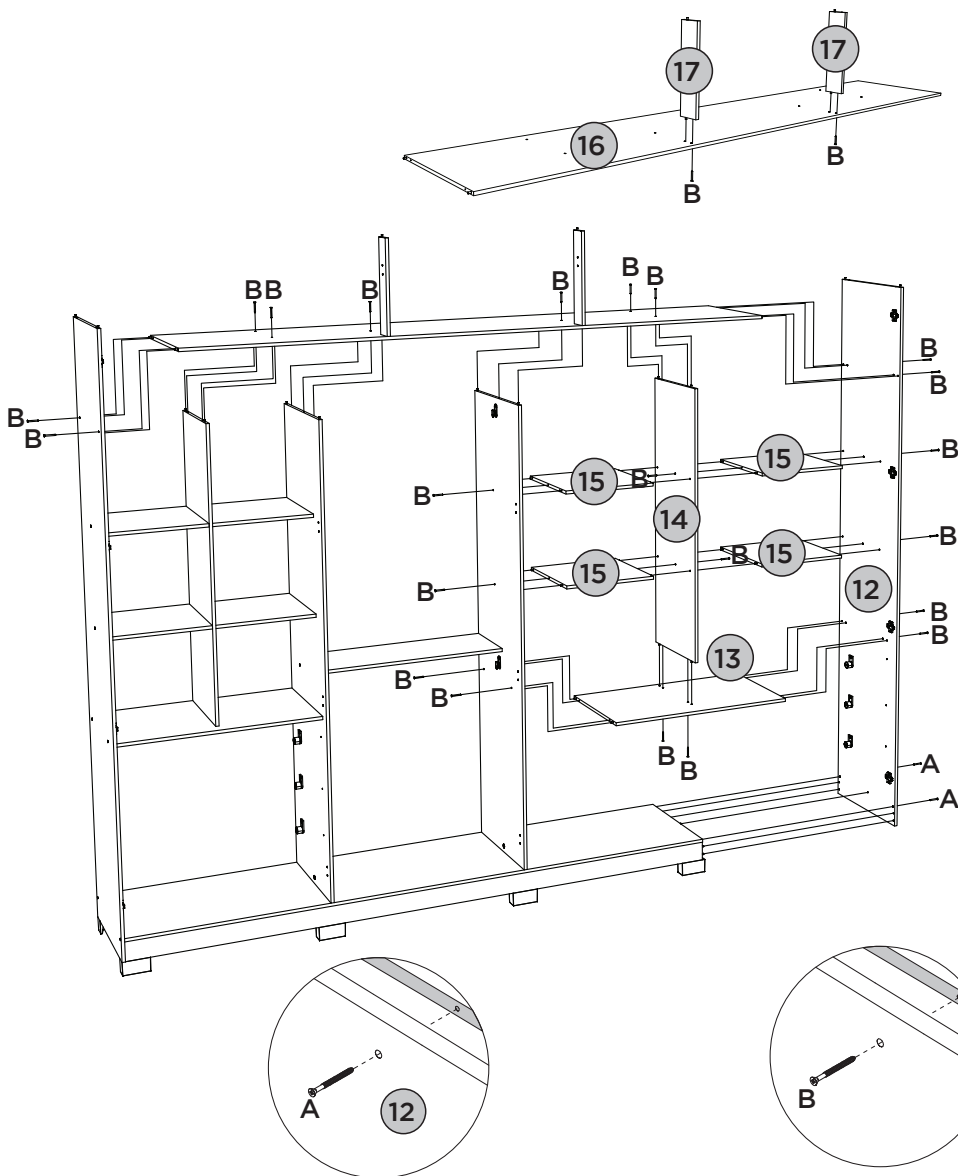
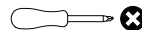

## FERRAMENTAS NECESSÁRIAS



## PEÇAS REQUERIDAS

|    |              |  |
|----|--------------|--|
| 18 | TAMPO        |  |
| 19 | RIPA LATERAL |  |

## ACESSÓRIOS REQUERIDOS

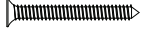
|   |   |   |    |
|---|---|---|----|
| B |  |  | 06 |
| C |  |  | 12 |



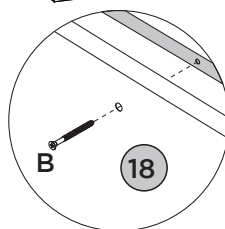
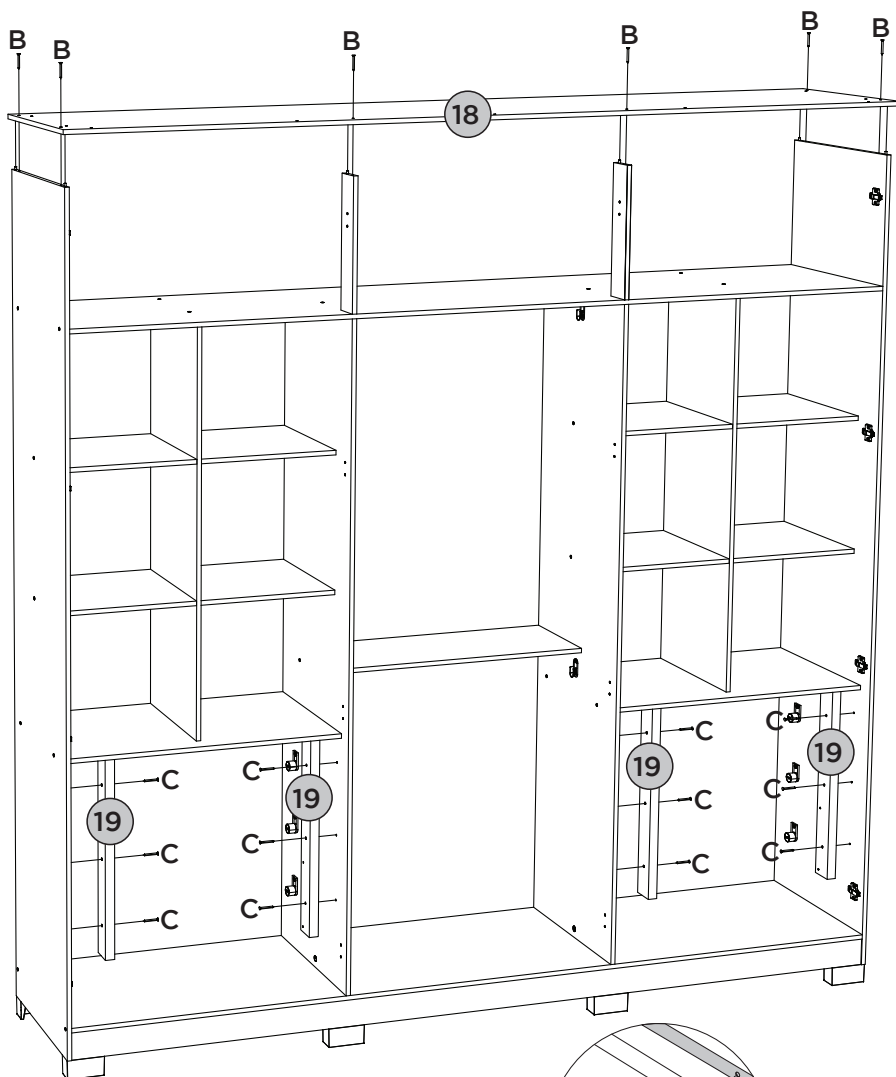
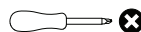



## FERRAMENTAS NECESSÁRIAS



## PEÇAS REQUERIDAS

|    |                          |    |
|----|--------------------------|----|
| 20 | MOLDURA LATERAL          | x2 |
| 21 | MOLDURA FRONTAL SUPERIOR | x1 |

## ACESSÓRIOS REQUERIDOS

|   |   |    |
|---|---|----|
| D |  | 09 |
| E |  | 16 |
| H |  | 24 |
| R |  | 16 |
| T |  | 16 |
| Z |  | 06 |

## FERRAMENTAS NECESSÁRIAS

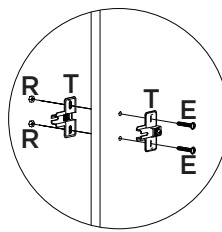
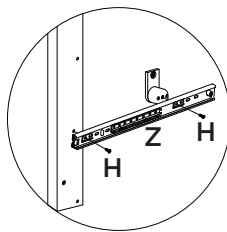
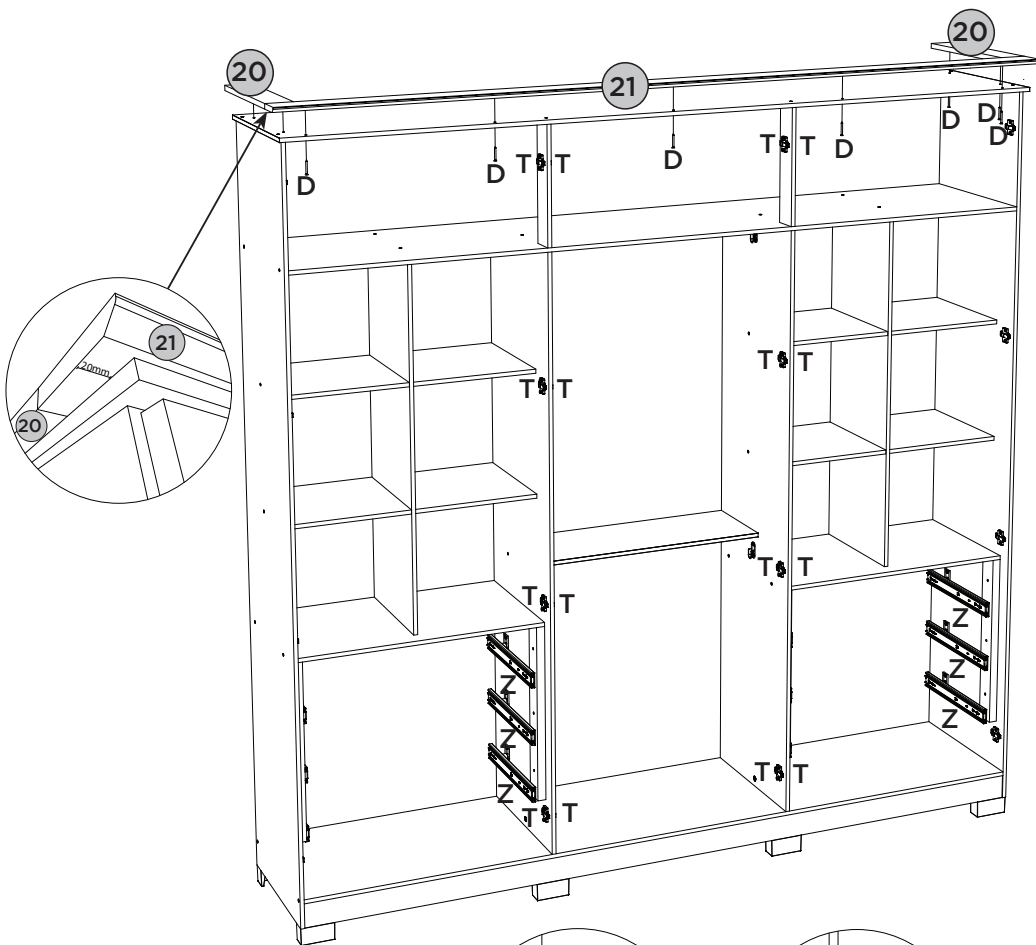
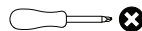





## PEÇAS REQUERIDAS

|    |                |    |
|----|----------------|----|
| 22 | FUNDO SUPERIOR | x1 |
| 23 | FUNDO          | x6 |

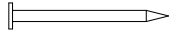
## ACESSÓRIOS REQUERIDOS

|    |   |     |
|----|---|-----|
| M  |  | 208 |
| N  |  | 53  |
| AA |  | 03  |

## FERRAMENTAS NECESSÁRIAS

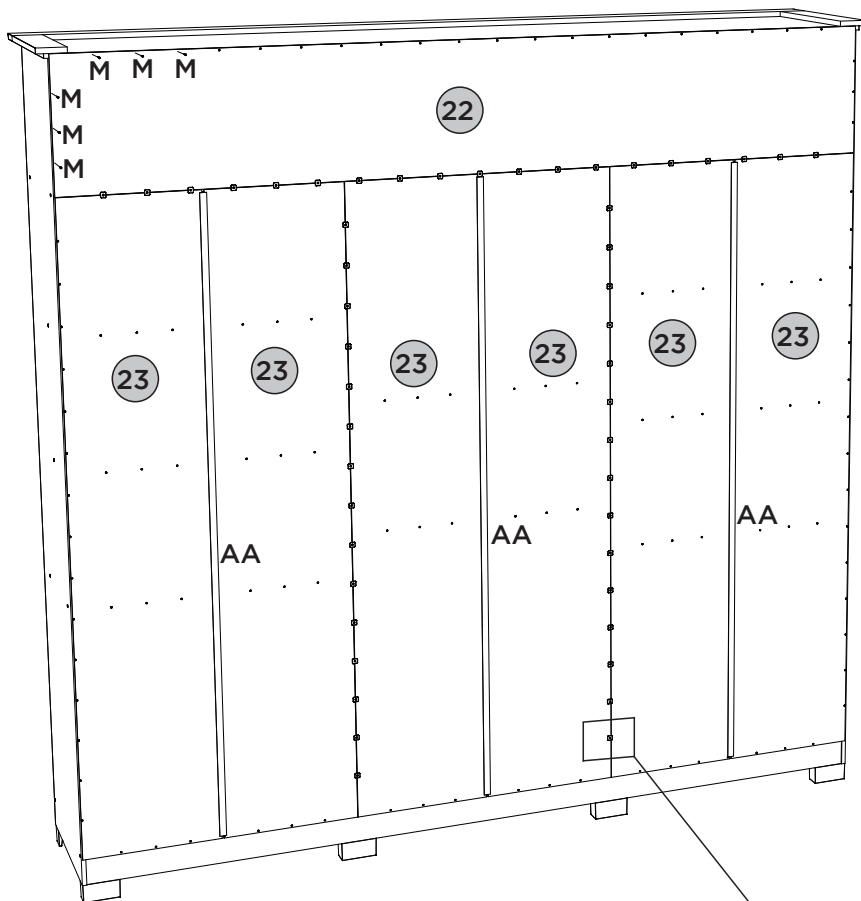
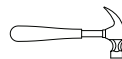

Fixar os pregos a uma distância de 100mm de um para outro.

Fijar las uñas a un distancia de 100mm uno a otro.



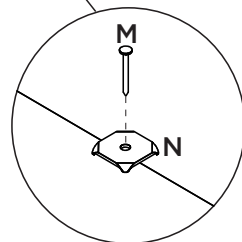

Fix the nails at a distance of 100mm from one to the other

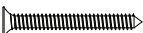

## PEÇAS REQUERIDAS

|    |               |    |
|----|---------------|----|
| 24 | PORTA         | x6 |
| 25 | APLIQUE MAIOR | x3 |
| 26 | APLIQUE MENOR | x3 |

## ACESSÓRIOS REQUERIDOS

|   |   |   |    |
|---|---|---|----|
| C |  |  | 24 |
| H |  |  | 48 |
| U |  |   | 24 |
| X |  |   | 24 |

## FERRAMENTAS NECESSÁRIAS

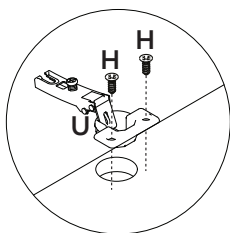
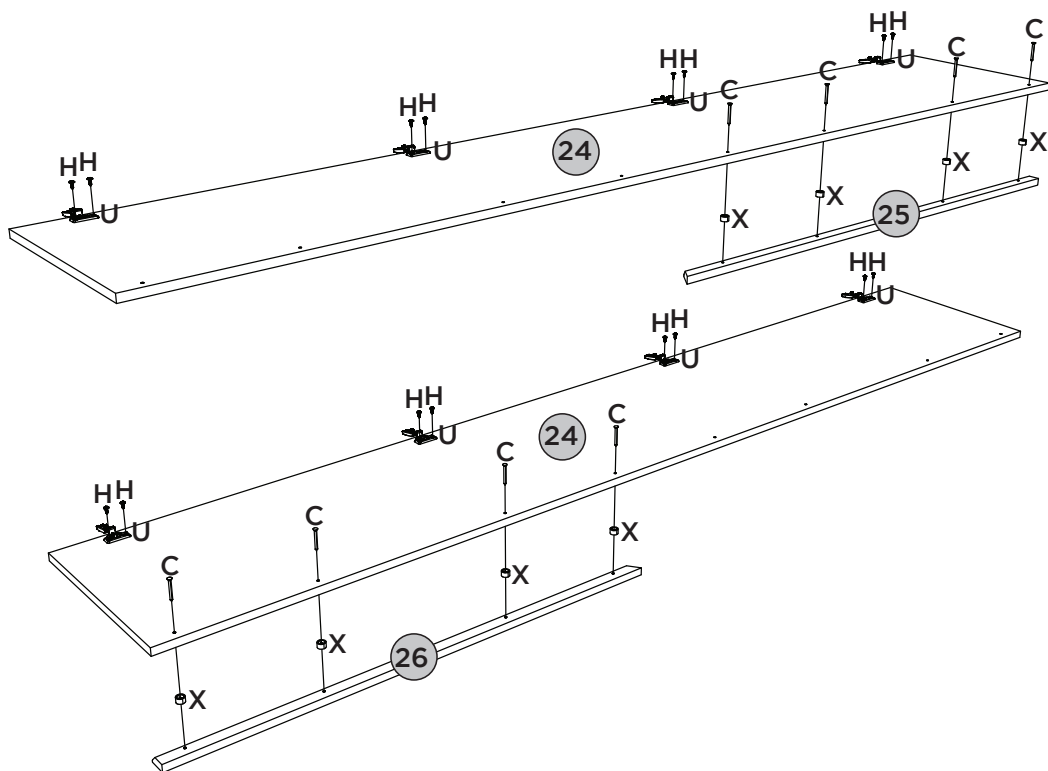
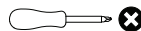

Vídeo: Instalar e regular Dobradiças

Video: Instale y ajuste las bisagras

Video: Install and adjust hinges

## PEÇAS REQUERIDAS

|    |       |    |
|----|-------|----|
| 24 | PORTA | x6 |
|----|-------|----|

## ACESSÓRIOS REQUERIDOS

|   |   |    |
|---|---|----|
| Y |  | 02 |
|---|---|----|

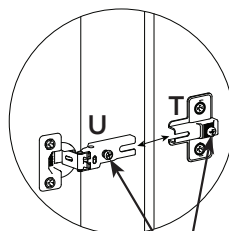
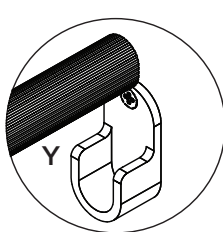
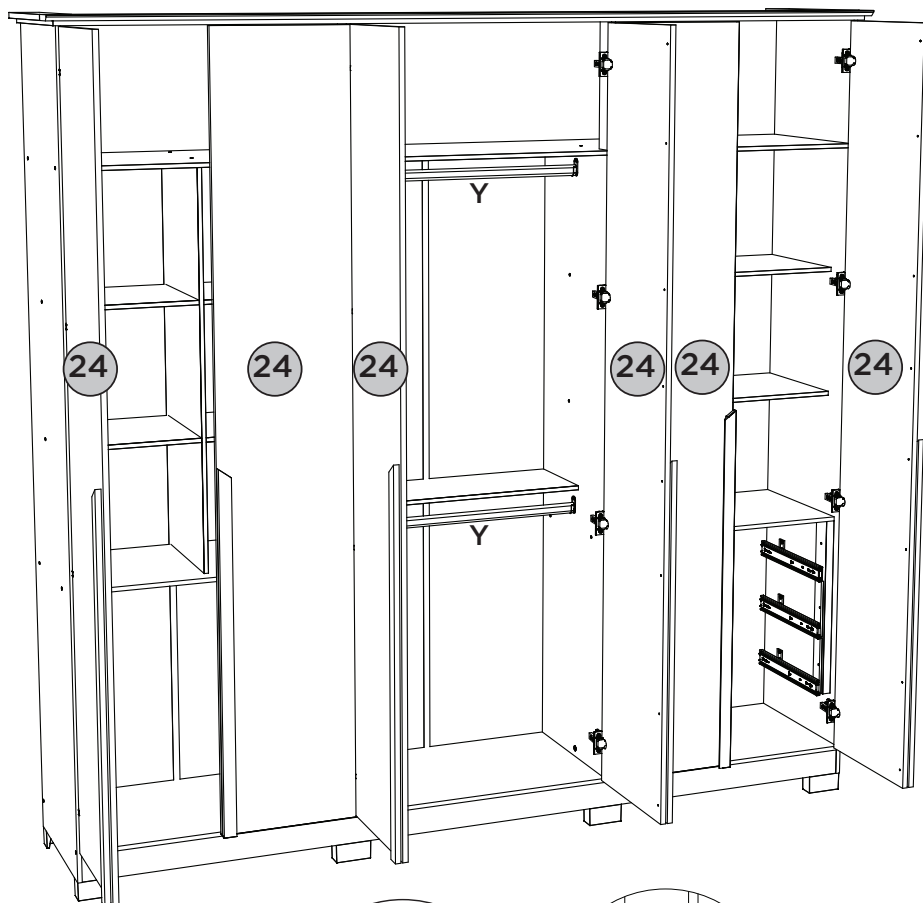

Parafusos indicados na imagem, devem ser inseridos, caso venham soltos no pacote.

Los tornillos indicados en la imagen deben ser insertados, si se sueltan en el paquete.

Screws indicated in the image must be inserted if they are loose in the package.



# PASSO 15

ITM/D309-

## PEÇAS REQUERIDAS

|    |                |     |
|----|----------------|-----|
| 28 | LADO DE GAVETA | x12 |
|----|----------------|-----|

## ACESSÓRIOS REQUERIDOS

|    |   |    |
|----|---|----|
| J  |  | 48 |
| AB |  |    |

## FERRAMENTAS NECESSÁRIAS

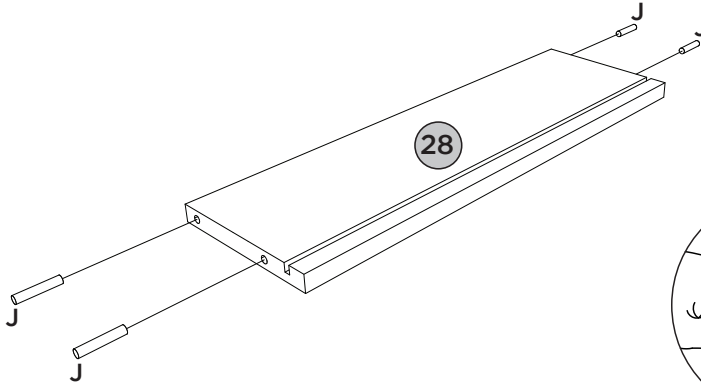

# PASSO 16

## PEÇAS REQUERIDAS

|    |                |     |
|----|----------------|-----|
| 27 | RIPA DE TRÁS   | x6  |
| 28 | LADO DE GAVETA | x12 |

## ACESSÓRIOS REQUERIDOS

|    |   |  |
|----|---|--|
| AB |  |  |
|----|---|--|

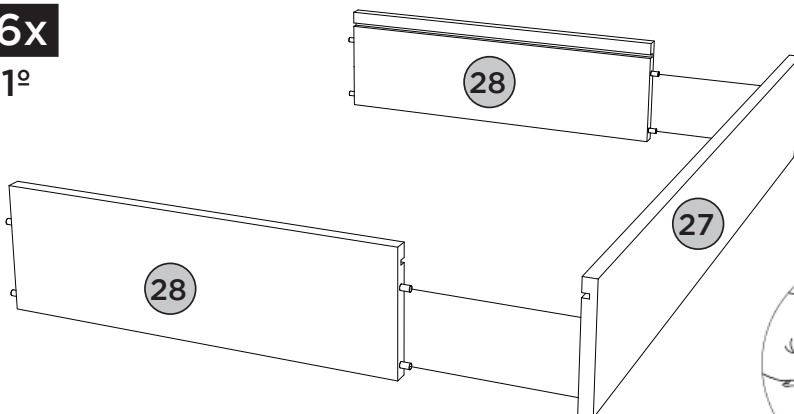

**6x**  
1º



## PEÇAS REQUERIDAS

|    |                              |    |
|----|------------------------------|----|
| 29 | FUNDO DE GAVETA<br>RECORTADO | x6 |
| 30 | FRENTE DE GAVETA             | x6 |

## ACESSÓRIOS REQUERIDOS

|    |   |    |
|----|---|----|
| I  |   | 12 |
| AB |  |    |

## FERRAMENTAS NECESSARIAS

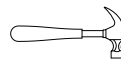
**6x**



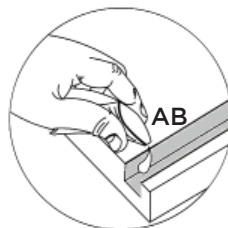
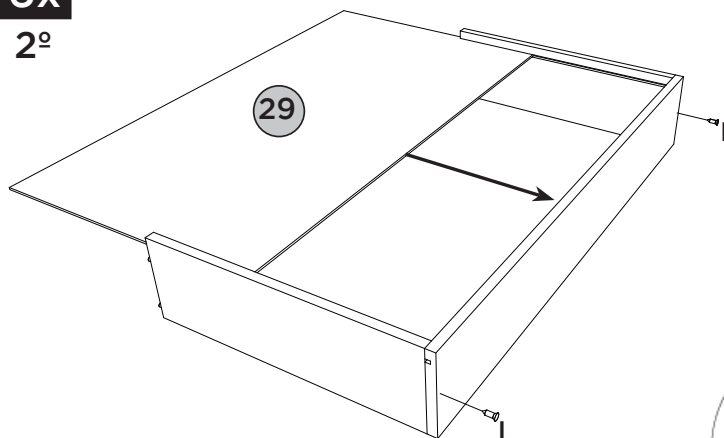

2º

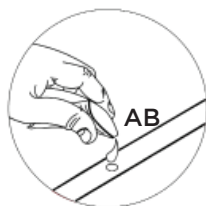
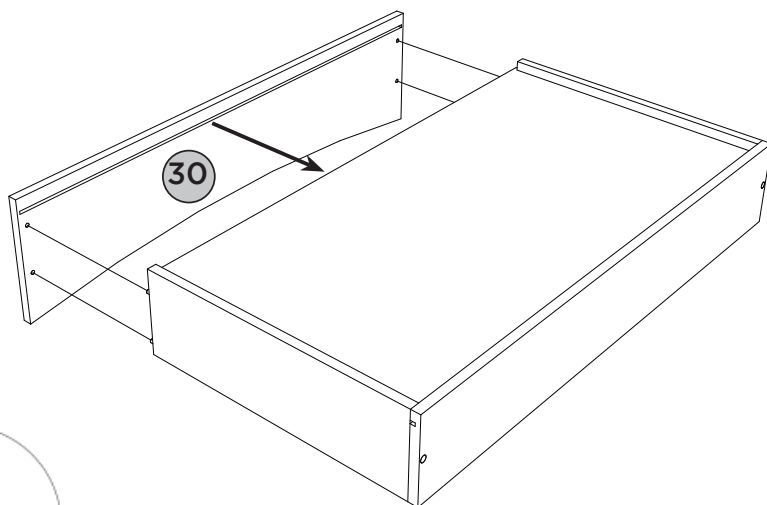
**6x**

3º



ACESSÓRIOS REQUERIDOS

|   |   |    |
|---|---|----|
| F |  | 12 |
| H |  | 60 |
| O |  | 12 |
| P |  | 12 |
| Z |  | 06 |

FERRAMENTAS NECESSÁRIAS

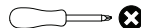

**6x**

4º

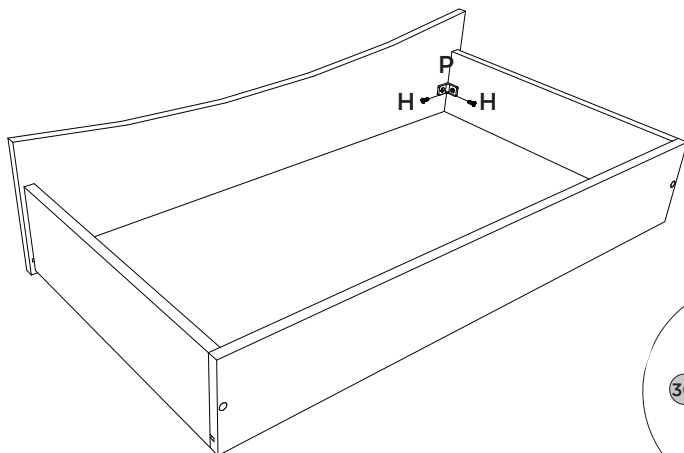

Deixar 3mm de distância da frente de gaveta.

Deje una separación de 3mm del frente del cajón.



Leave 3mm away from the front of the drawer.

**6x**

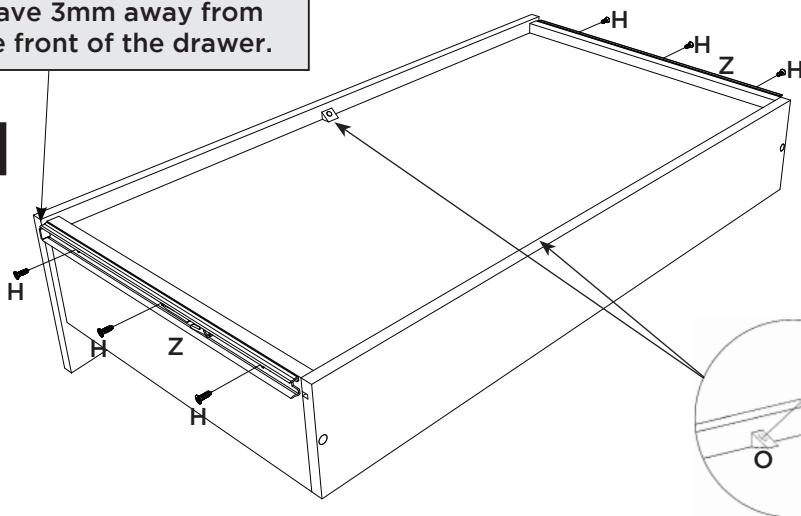
5º



### ACESSÓRIOS REQUERIDOS

|    |   |    |
|----|---|----|
| G  | HENN  | 01 |
| AC |  | 03 |
| AD |  | 04 |
| AE |  | 42 |

**Pesos máximos recomendados com carga distribuída**  
**Peso máximo recomendado con la carga distribuida**  
**Recommended maximum weight with distributed load.**

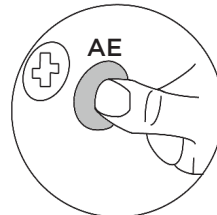
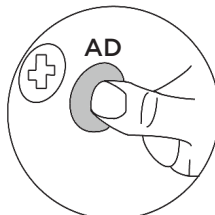
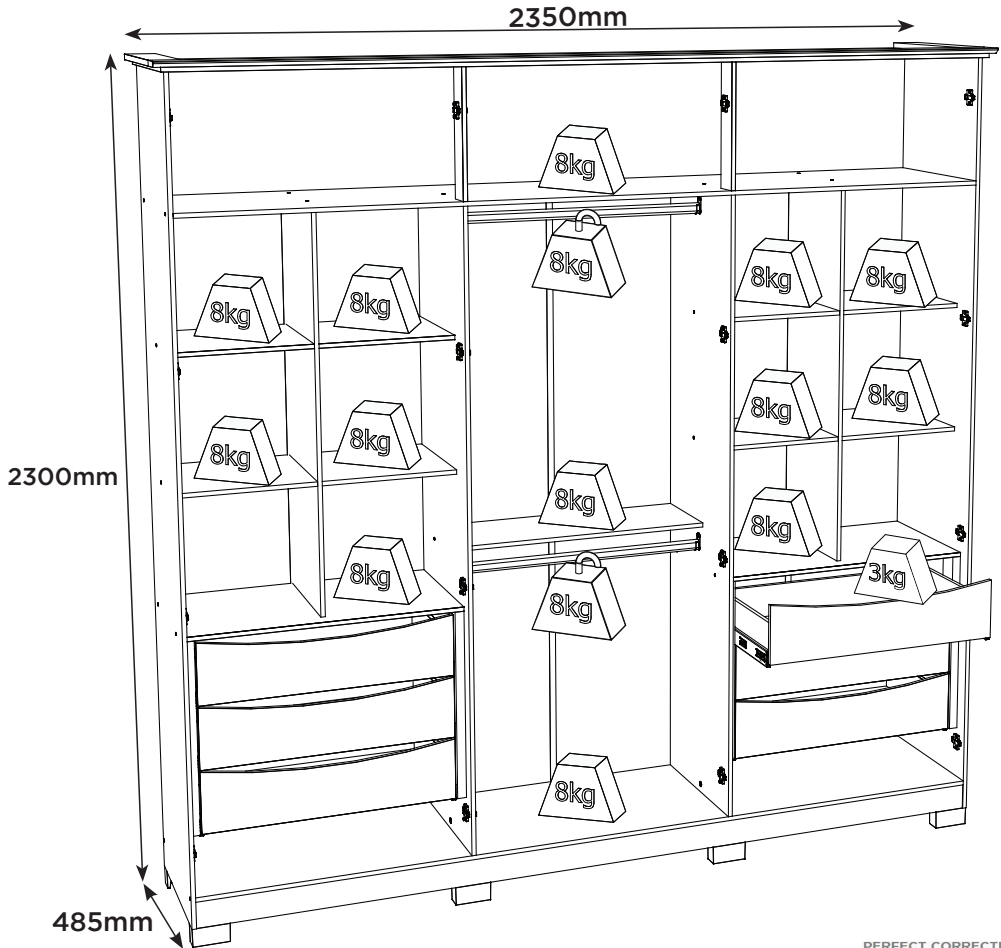

**PERFECT CORRECTION**  
**CORRECCIÓN PERFECTA**

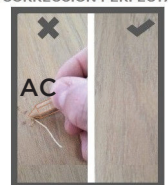



**O914-64 - Kit Espelho 850 x 220 x 2mm  
com 2 unidades**

Esse Kit Espelho é opcional e é vendido separadamente.

Este juego de espejos es opcional y se vende por separado.

This Mirror Kit is optional and sold separately.

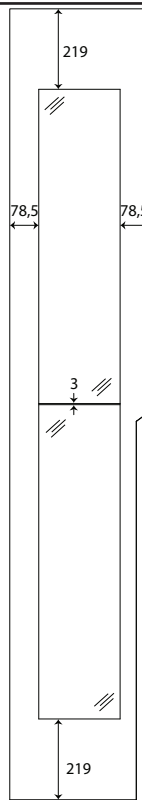
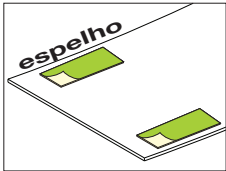

**Produto Concluído  
Producto terminado  
Finished Product**

