

HENN

Ind. e Com. de Móveis Henn
Mondaiá - SC - Brasil

+55 49 3674.3500

@moveishenn
www.henn.com.br

ITM/D300-
**INSTRUÇÕES DE
MONTAGEM**

ROUPEIRO ASTON O2 PORTAS DESLIZANTES

ARMARIO ASTON O2 PUERTAS DESLIZANTES | ASTON O2 WARDROBE SLIDING DOORS

D300-209 Nature/Off White/Verde HP

D300-210 Jequitibá Brilho/Jequitibá Brilho/Preto HP

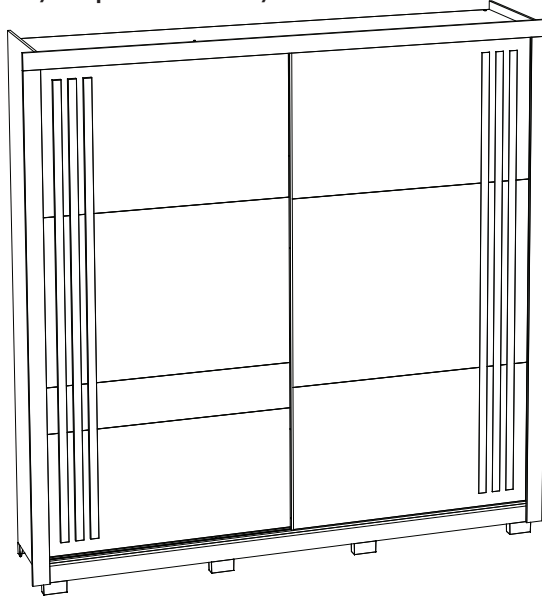

Requisitos para montagem
Requisitos para la montaje
Assembly Requirements

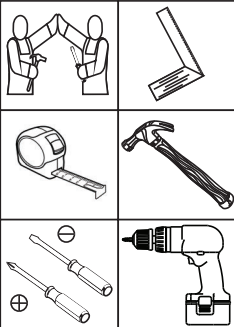

Imagens meramente ilustrativas,
não acompanha o produto.
Imágenes ilustrativas, no incluidas
con el producto.
Illustrative images, not included
with the product.

Para limpeza de seu móvel, use uma flanela seca ou umedecida, e não utilize produtos químicos que possam danificar seu produto.

SISTEMA DE MONTAGEM

O sistema de montagem dos produtos, funciona de acordo com a ordem crescente dos números indicados no desenho. Ex: 01, 02, 03, 04... até a conclusão da montagem.

ASSISTÊNCIA TÉCNICA

Para solicitação de Assistência Técnica você consumidor deverá entrar em contato com o Lojista a qual você realizou a compra deste produto e solicitar a assistência técnica das peças avariadas. A garantia abrange todas as peças, partes e componentes que eventualmente venham apresentar defeito de fabricação no prazo de 03 (três) meses, contando a partir da entrega do produto ao consumidor, mediante nota fiscal de compra. Se houver qualquer alteração na estrutura do produto ou ocorrer defeito por negligência do montador/consumidor em relação a instrução de montagem e manuseio, não será fornecido assistência técnica gratuita.

ADVERTENCIA

Para limpieza de su móvil, use una flanela seca o húmeda, y no utilice productos químicos que puedan dañar su producto.

SISTEMA DE MONTAJE

El sistema de montaje de los productos funciona de acuerdo con el orden creciente de los números indicados en el dibujo. Ej.: 01, 02, 03, 04... hasta la conclusión del montaje.

ASSISTÊNCIA TÉCNICA

Para solicitar Assistência Técnica, el consumidor debe comunicarse con el Comercio que usted realizó la compra de este producto y solicita asistencia técnica para las partes dañadas. La garantía cubre todas las partes, piezas y componentes que eventualmente puedan presentar defecto de fabricación en el plazo de 03 (tres) meses, contados a partir de la entrega del producto al consumidor, mediante factura de compra. Si se produce algún cambio en la estructura del producto o se produce un defecto por negligencia del montador/consumidor en relación con las instrucciones de montaje y manipulación, no se prestará asistencia técnica gratuita.

NOTICE

ASSEMBLY SYSTEM

The products' assembly system works according to the increasing order of the indicated numbers. For example: 01, 02, 03, 04 ... to the end of the assembly.

TECHNICAL ASSISTANCE

To request Technical Assistance, the consumer must contact the retailer from whom you purchased this product and request technical assistance for the damaged parts. The warranty covers all parts, parts and components that may eventually present a manufacturing defect within a period of 03 (three) months, counting from the delivery of the product to the consumer, by means of a purchase invoice. If there is any change in the structure of the product or defect occurs due to negligence of the assembler/consumer in relation to the assembly and handling instruction, free technical assistance will not be provided.

ACESSÓRIOS | ACCESORIOS | ACCESSORIES

A



x8

B



x8

C



x26

D



x42

E



x74

F



x114

G



x32

H

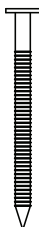

x8

I



x174

J

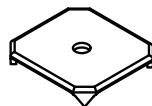

x50

K

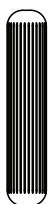

x100

L

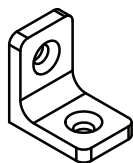

x20

M

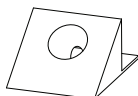

x8

N

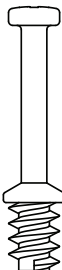

x2

O



x2

Parafusos em escala
Tornillos escalados
Scaled screws

1:1

ACESSÓRIOS | ACCESORIOS | ACCESSORIES

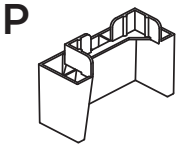

x8



x13

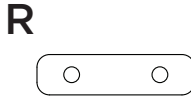

x17



x8

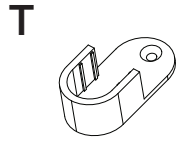

x4



x2

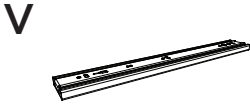

x4 PAR

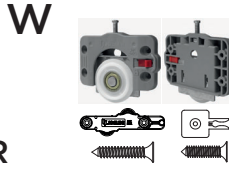

x1 KIT



x3



x1

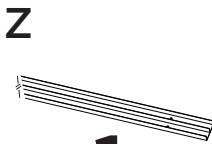

x1

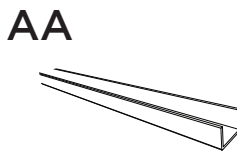

x4

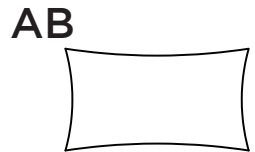

x2

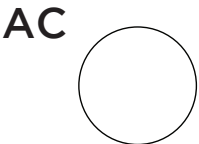

x4



x24



x30

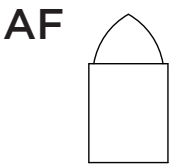

x3

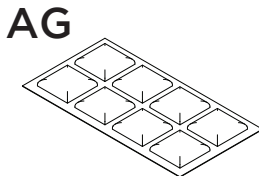

x16



x1

LISTA DE PEÇAS | LISTA DE PIEZAS | LIST OF PIECES

35Item	Caixa Caja Box	Qtd Ctd Qty	Descrição Descripción Description	Dimensões (mm) Dimensiones (mm) Dimensions (mm)		
				Comprimento Largo Length	Largura Ancho Width	Espessura Grosor Thickness
1	2/3	1	RODAPÉ FRONTAL FALDÓN DELANTERO FRONT SKIRTING	2166	73	12
2	1/3	2	TRAVESSA DO RODAPÉ PLACA DE RODAPIÉ SKIRTING PLATE	470	73	12
3	2/3	1	RODAPÉ TRASEIRO REPOSAPIÉS TRASERO BACK FOOTBOARD	2166	73	12
4	1/3	1	BASE BASE BASE	2166	500	12
5	2/3	1	LATERAL ESQUERDA LATERAL IZQUIERDA LEFT SIDE	2250	500	12
6	1/3	1	DIVISÃO INFERIOR ESQUERDA DIVISIÓN INFERIOR IZQUIERDA BOTTOM LEFT DIVISION	700	400	12
7=11	1/3	1	TAMPO DAS GAVETAS TAPA DE LOS CAJONES TOP OF DRAWERS	727	400	12
8	2/3	1	DIVISÃO SUPERIOR ESQUERDA DIVISIÓN SUPERIOR IZQUIERDA UPPER LEFT DIVISION	977	50	12
9=17	1/3	2	PRATELEIRA ESTANTE SHELF	714	350	12
10	1/3	1	DIVISÃO INFERIOR DIREITA DIVISIÓN INFERIOR DERECHA LOWER RIGHT DIVISION	700	400	12
11=7	1/3	1	TAMPO DAS GAVETAS TAPA DE LOS CAJONES TOP OF DRAWERS	727	400	12
12	2/3	1	DIVISÃO SUPERIOR DIREITA DIVISIÓN SUPERIOR DERECHA UPPER RIGHT DIVISION	977	50	12
13	1/3	1	PRATELEIRA DO CALCEIRO ESTANTE DE CALCEIRO CALCEIRO'S SHELF	714	250	12
14	2/3	1	CHÃO DO MALEIRO REPISA SUPERIOR FLOOR OF MALEIRO	2166	400	12
15	1/3	2	RIPA DO MALEIRO TRAVESAÑO SUPERIOR MALEIRO'S LATH	414	73	12
16	1/3	1	TAMPO SUPERIOR TAPA SUPERIOR TOP PANEL	2166	500	12
17=9	1/3	2	PRATELEIRA ESTANTE SHELF	714	350	12
18	2/3	1	LATERAL DIREITA LADO DERECHO RIGHT SIDE	2250	500	12
19	2/3	1	FUNDO SUPERIOR FONDO TOP TOP FUND	2184	431	3
20	2/3	6	FUNDO FONDO BOTTOM	1706	360	3
21	1/3	2	MOLDURA LATERAL MARCO LATERAL LATERAL FRAME	2177	73	12
22	2/3	1	MOLDURA SUPERIOR MARCO SUPERIOR FRAME SUPERIOR	2290	73	12
23	1/3	4	RIPA LATERAL RIPA LATERAL SIDE CLAPBOARD	395	58	25
24	3/3	1	PAINEL INFERIOR PANEL INFERIOR PANEL BOTTOM	1094	532	12
25	3/3	1	PAINEL MENOR PANEL MENOR MINOR PANEL	1094	200	12
26	3/3	1	PAINEL CENTRAL PANEL CENTRAL CENTRAL PANEL	1094	722	12
27=30	3/3	1	PAINEL INFERIOR SUPERIOR PANEL INFERIOR SUPERIOR TOP BOT- TOM PANEL	1094	632	12
28=31	2/3	3	MOLDURA MARCO FRAME	1965	35	12
29	3/3	1	PAINEL CENTRAL MAIOR PANEL CENTRAL MAYOR LARGER CENTER PANEL	1094	822	12
30=27	3/3	2	PAINEL INFERIOR SUPERIOR PANEL INFERIOR SUPERIOR TOP BOT- TOM PANEL	1094	632	12
31=28	2/3	3	MOLDURA MARCO FRAME	1965	35	12
32	1/3	4	RIPA DE TRÁS MALLA DETRÁS REAR LATH	669	122	12
33	1/3	8	LADO DE GAVETA LADO DEL CAJÓN SIDE OF DRAWER	350	122	12
34	1/3	4	FUNDO DE GAVETA RECORTADO FONDO DEL CAJÓN RECORTADO CROPPED DRAWER BOTTOM	656	361	3
35	2/3	4	FRENTE DE GAVETA FRENTE DE CAJÓN FRONT OF DRAWER	681	192	12

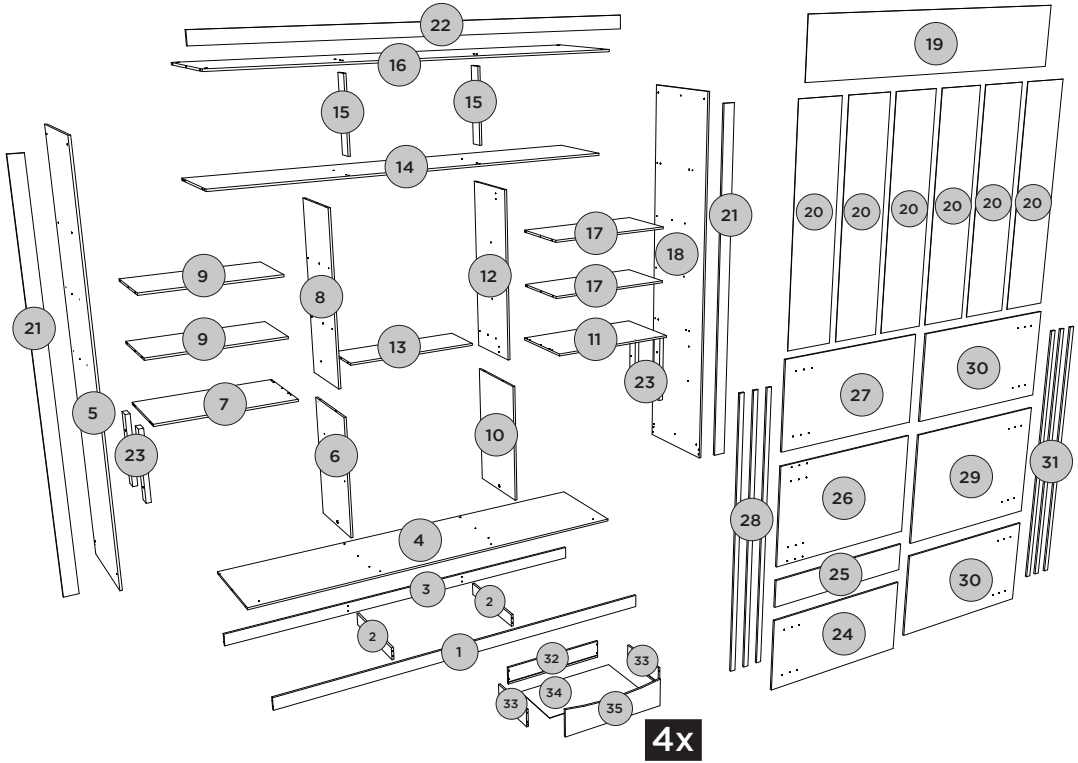

LISTA DE PEÇAS | LISTA DE PIEZAS | LIST OF PIECES



PEÇAS REQUERIDAS

1	RODAPÉ FRONTAL	x1
2	TRAVESSA DO RODAPÉ	x2
3	RODAPÉ TRASEIRO	x1
15	RIPA DO MALEIRO	x2

ACESSÓRIOS REQUERIDOS

E		04
K		20
L		04

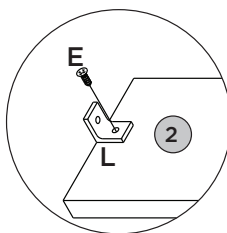
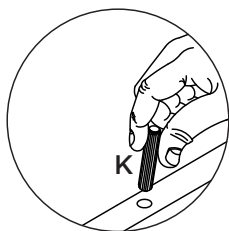
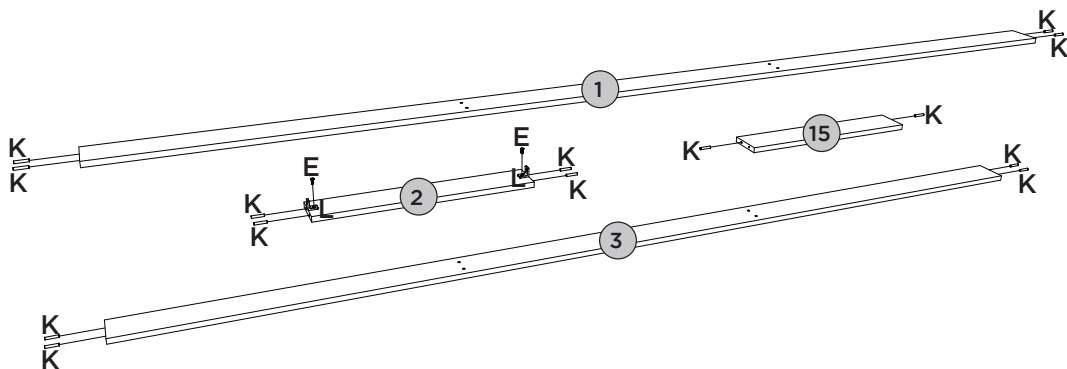
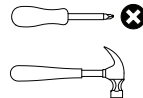

FERRAMENTAS NECESSÁRIAS



PEÇAS REQUERIDAS

4	BASE	x1
14	CHÃO DO MALEIRO	x1
16	TAMPO SUPERIOR	x1

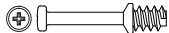
ACESSÓRIOS REQUERIDOS

K		08
N		02
S		08



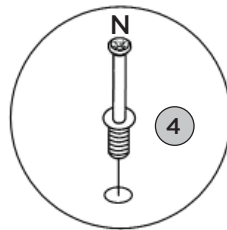
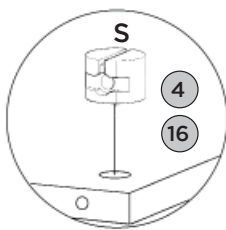
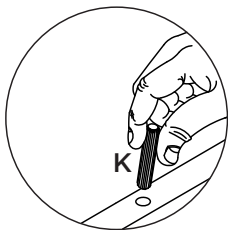
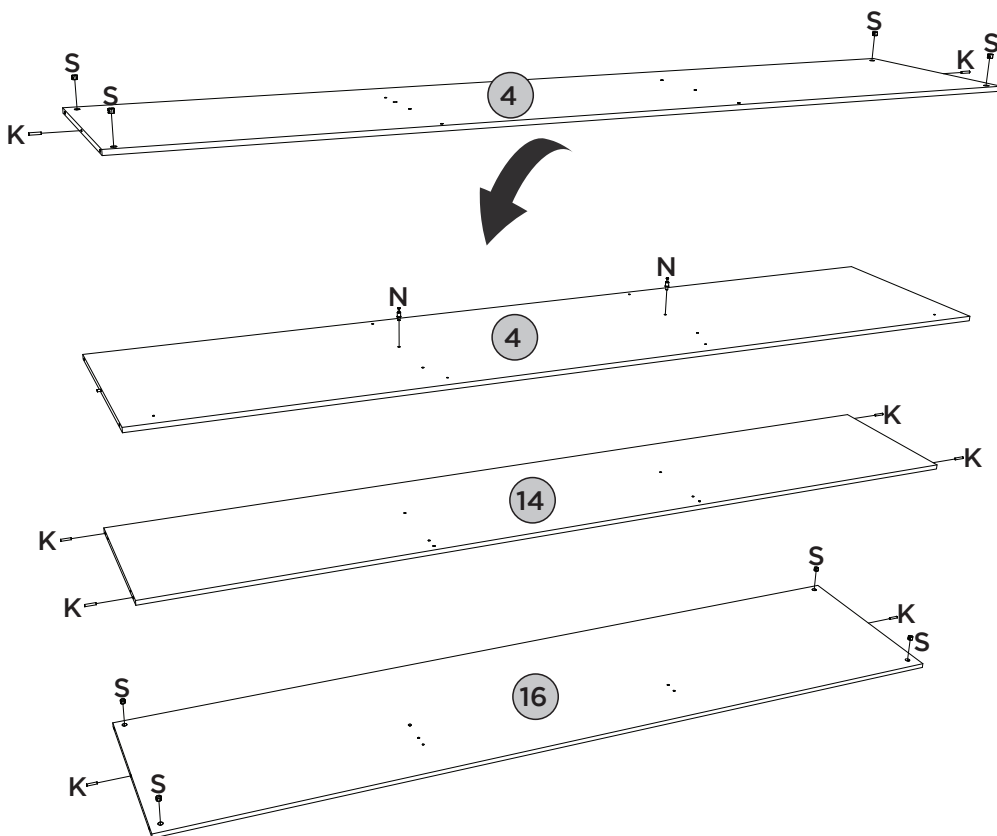
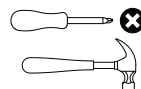

FERRAMENTAS NECESSÁRIAS



PEÇAS REQUERIDAS

6	DIVISÃO INFERIOR ESQUERDA	x1
7=11	TAMPO DAS GAVETAS	x2
10	DIVISÃO INFERIOR DIREITA	x1

ACESSÓRIOS REQUERIDOS

E		02
F		12
K		12
L		02
V		04

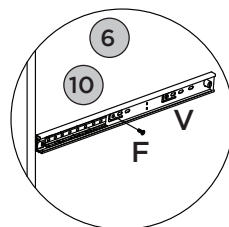
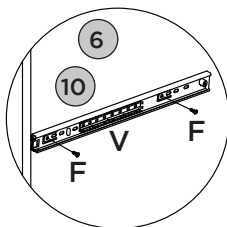
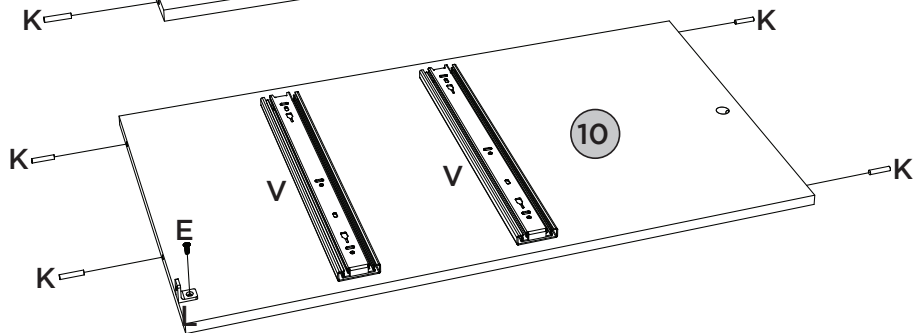
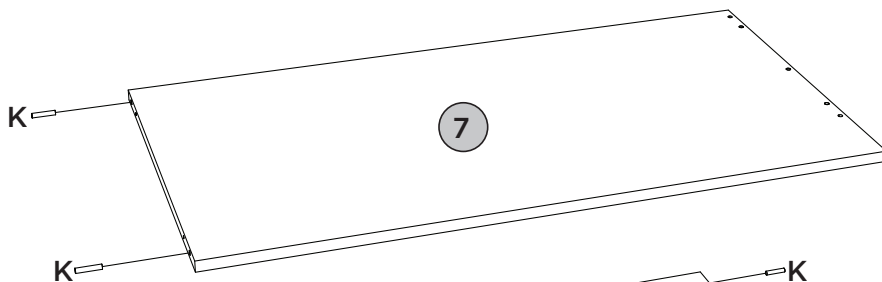
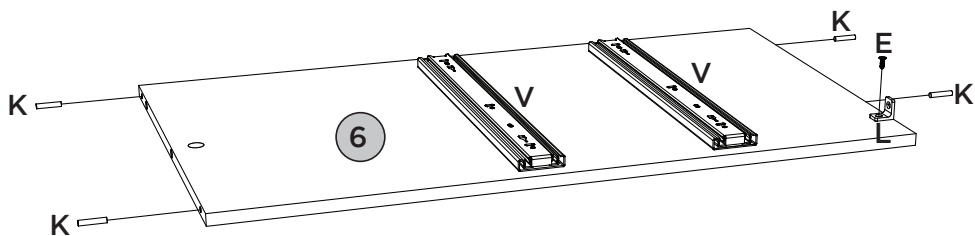
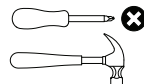

FERRAMENTAS NECESSÁRIAS



PEÇAS REQUERIDAS

8	DIVISÃO SUPERIOR ESQUERDA	x1
9=17	PRATELEIRA	x4
12	DIVISÃO SUPERIOR DIREITA	x1
13	PRATELEIRA DO CALCEIRO	x1

ACESSÓRIOS REQUERIDOS

F		08
K		28
T		04

FERRAMENTAS NECESSÁRIAS

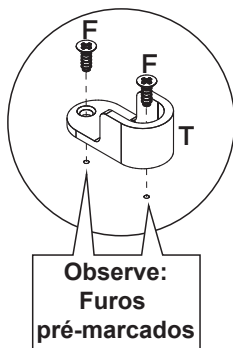
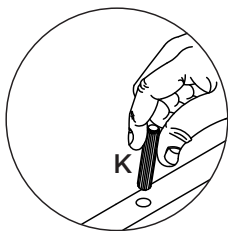
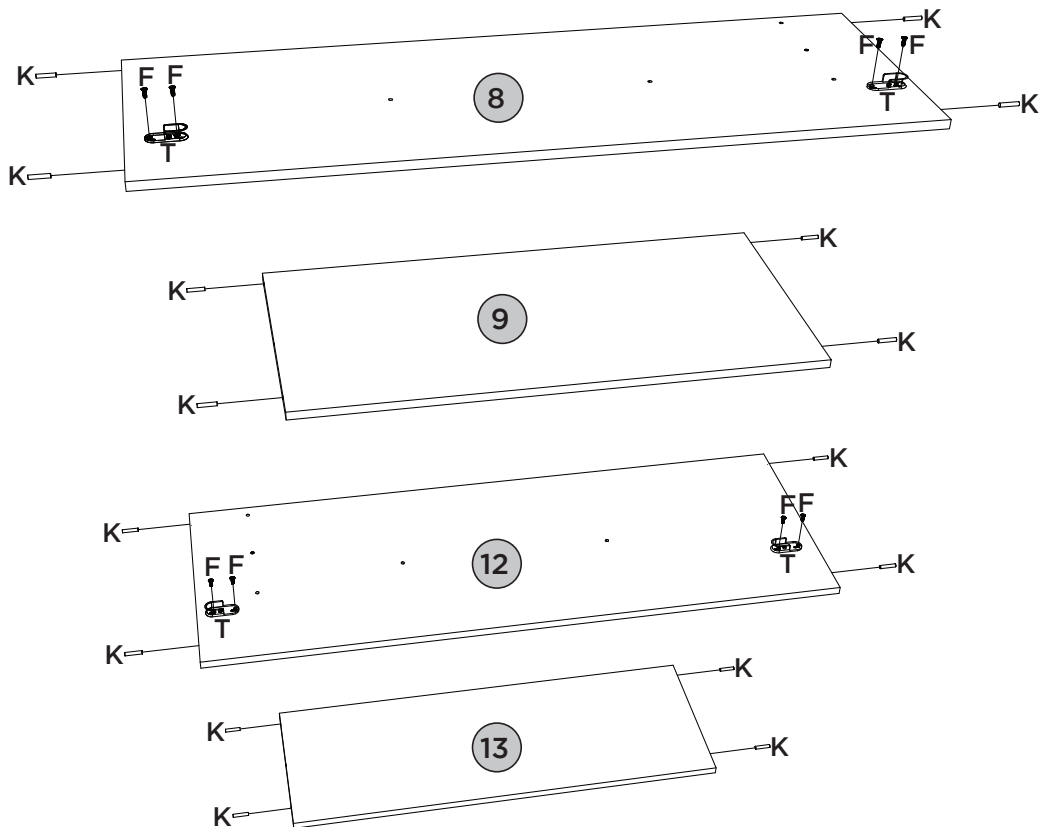
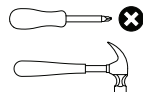

PASSO 5

ITM/D300-

PEÇAS REQUERIDAS

1	RODAPÉ FRONTAL	x1
2	TRAVESSA DO RODAPÉ	x2
3	RODAPÉ TRASEIRO	x1

ACESSÓRIOS REQUERIDOS

E		04
---	---	----



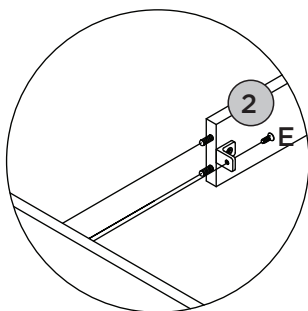
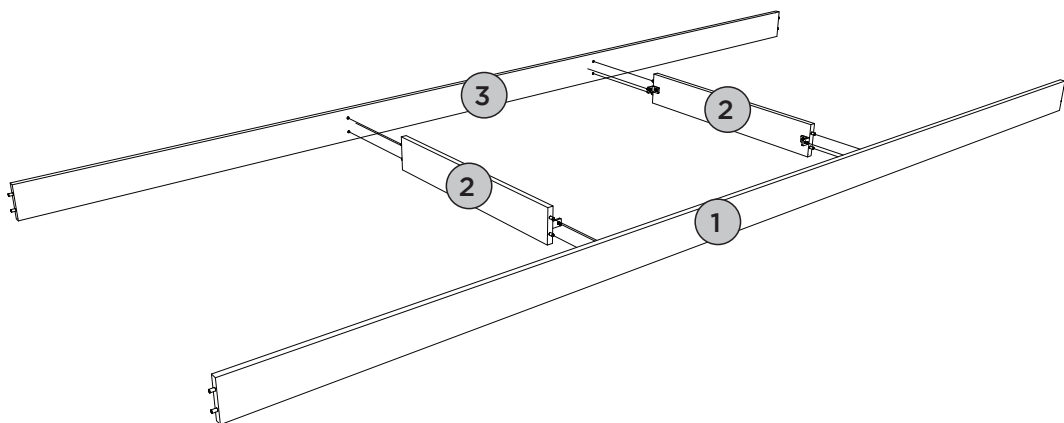
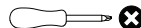

FERRAMENTAS NECESSÁRIAS



PEÇAS REQUERIDAS

4	BASE	x1
5	LATERAL ESQUERDA	x1
6	DIVISÃO INFERIOR ESQUERDA	x1

ACESSÓRIOS REQUERIDOS

A		02
E		36
L		06
O		01
P		08

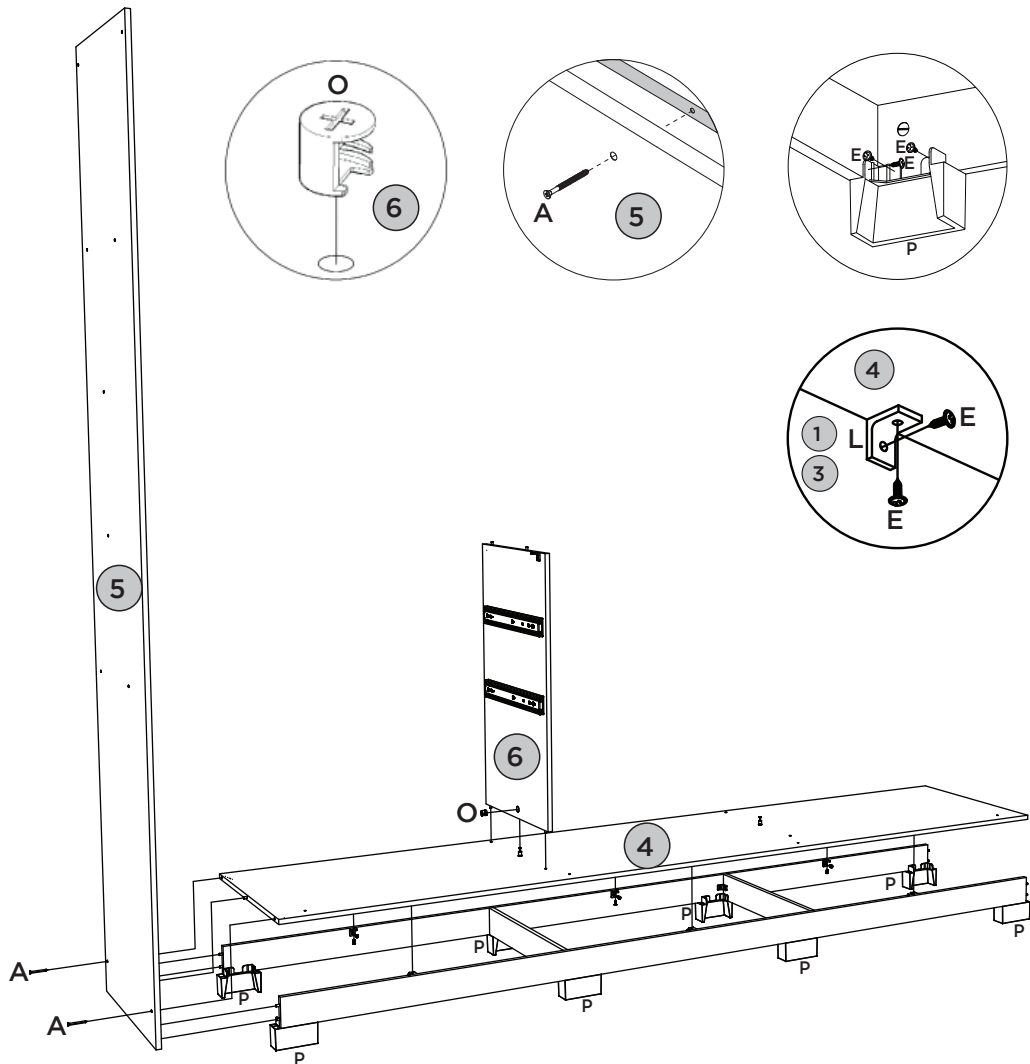
FERRAMENTAS NECESSÁRIAS

PEÇAS REQUERIDAS

7=11	TAMPO DAS GAVETAS	x1
8	DIVISÃO SUPERIOR ESQUERDA	x1

ACESSÓRIOS REQUERIDOS

C			O1
---	---	---	----

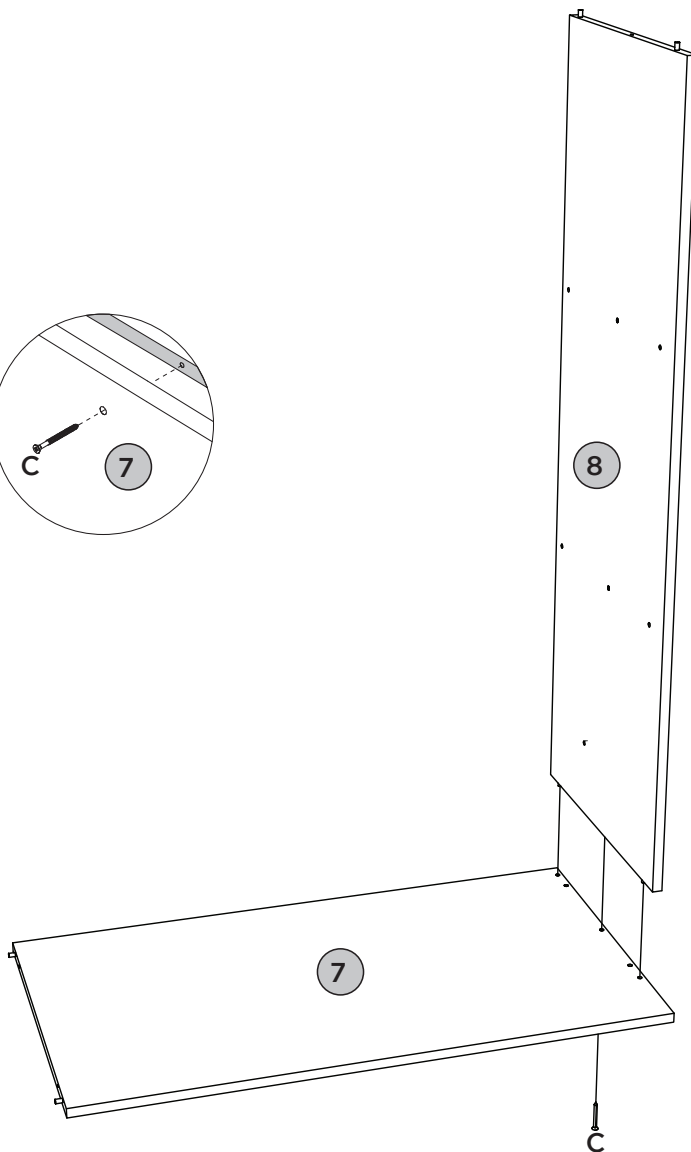
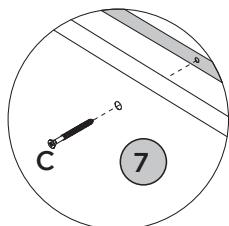
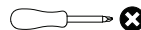

FERRAMENTAS NECESSÁRIAS



PEÇAS REQUERIDAS

9=17	PRATELEIRA	x2
10	DIVISÃO INFERIOR DIREITA	x1

ACESSÓRIOS REQUERIDOS

C		06
E		01
O		01

FERRAMENTAS NECESSÁRIAS

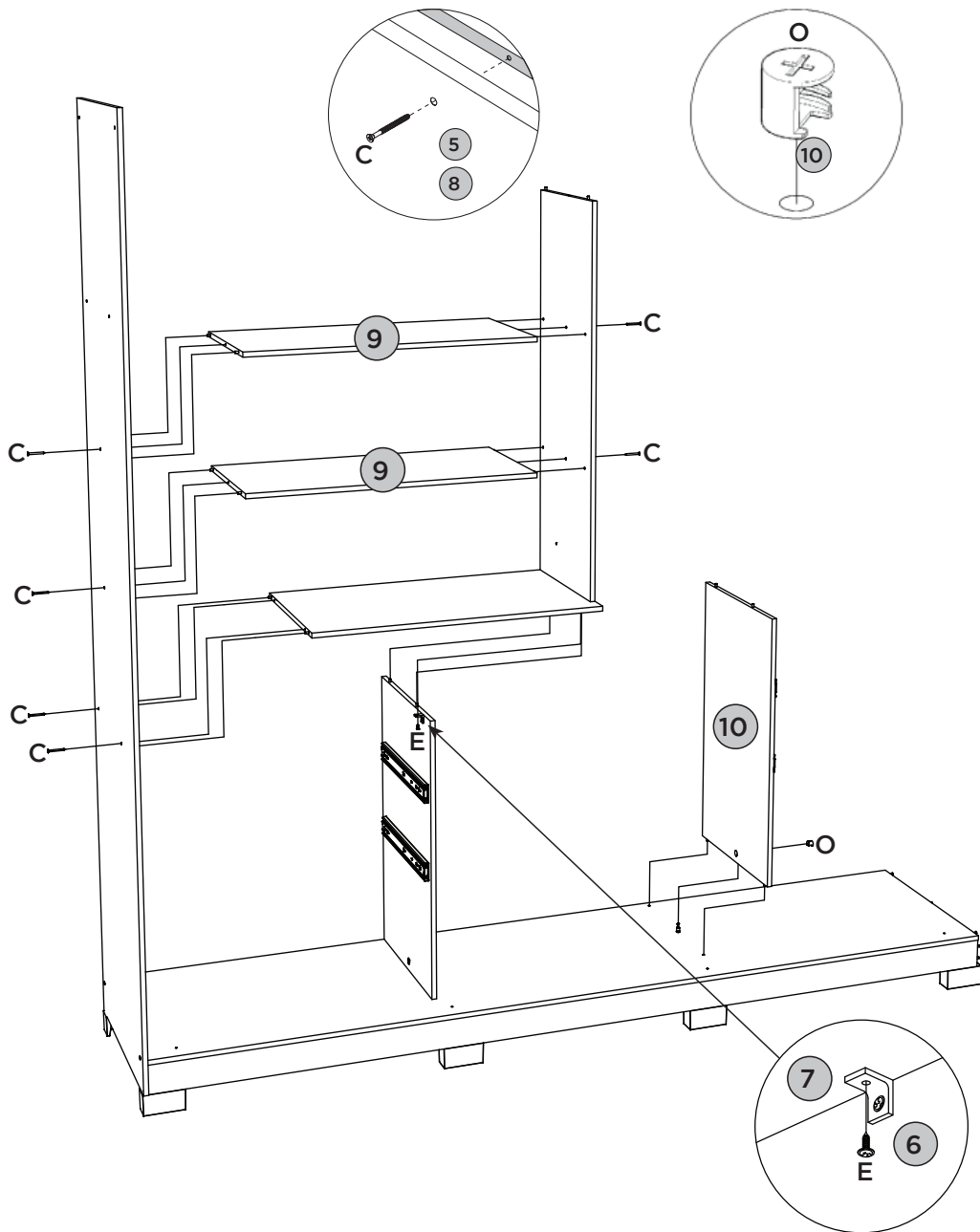
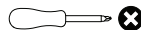

PEÇAS REQUERIDAS

11=7	TAMPO DAS GAVETAS	x1
12	DIVISÃO SUPERIOR DIREITA	x1

ACESSÓRIOS REQUERIDOS

C			01
---	---	---	----

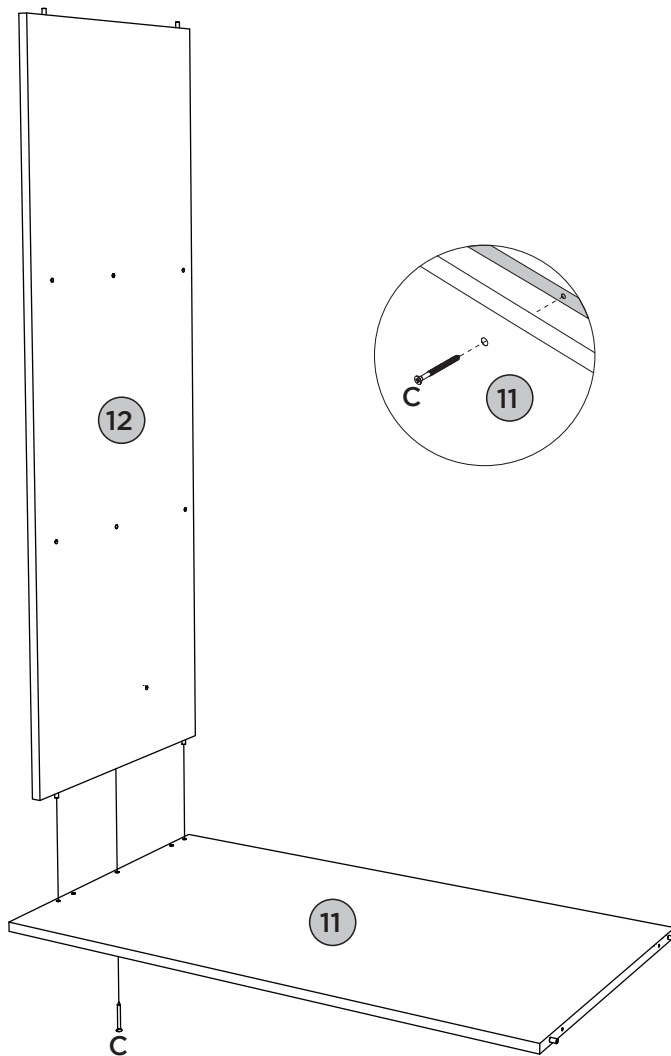
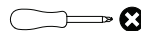

FERRAMENTAS NECESSÁRIAS



PEÇAS REQUERIDAS

13	PRATELEIRA DO CALCEIRO	x1
14	CHÃO DO MALEIRO	x1
15	RIPA DO MALEIRO	x2

ACESSÓRIOS REQUERIDOS

C		08
E		01

FERRAMENTAS NECESSÁRIAS

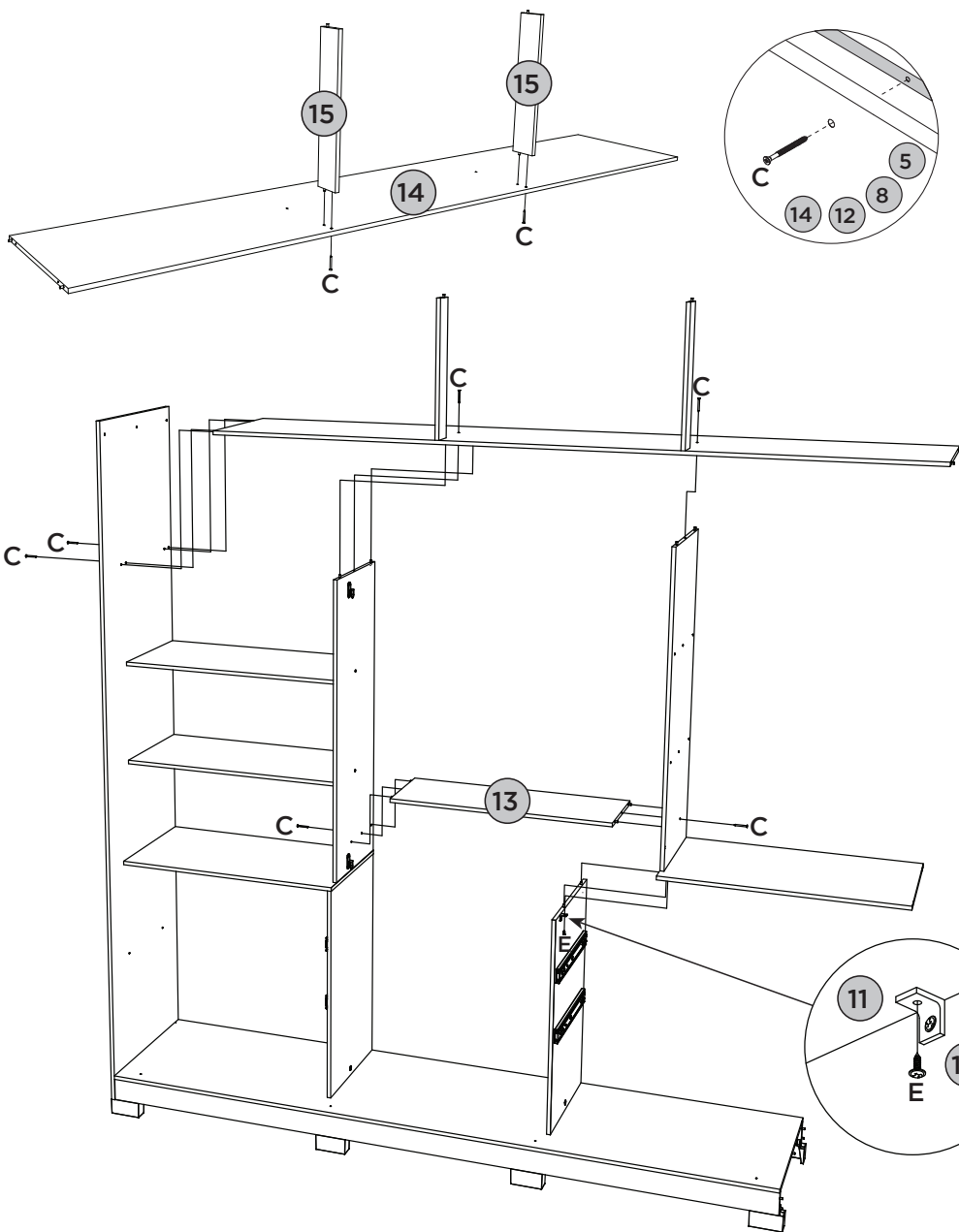

PEÇAS REQUERIDAS

16	TAMPO SUPERIOR	x1
17=9	PRATELEIRA	x2
18	LATERAL DIREITA	x1
23	RIPA LATERAL	x4

ACESSÓRIOS REQUERIDOS

A		06
B		08
C		10



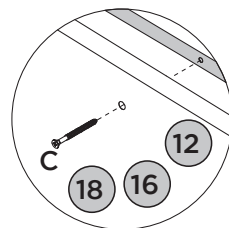
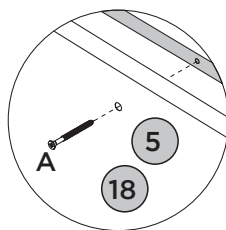
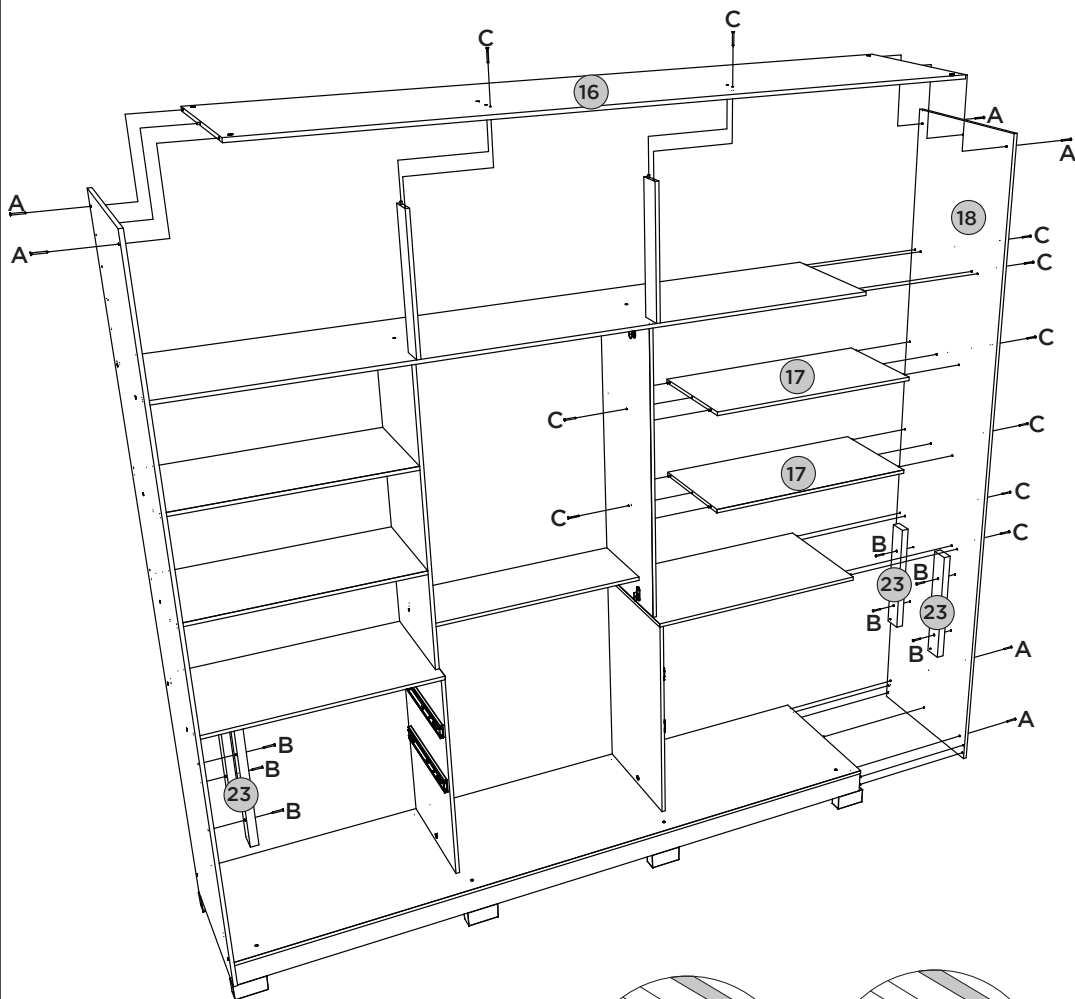
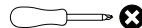



FERRAMENTAS NECESSÁRIAS



PEÇAS REQUERIDAS

19	FUNDO SUPERIOR	x1
20	FUNDO	x6
21	MOLDURA LATERAL	x1
22	MOLDURA SUPERIOR	x2

ACESSÓRIOS REQUERIDOS

E		26
F		04
I		174
J		50
Q		13
R		02
X		03

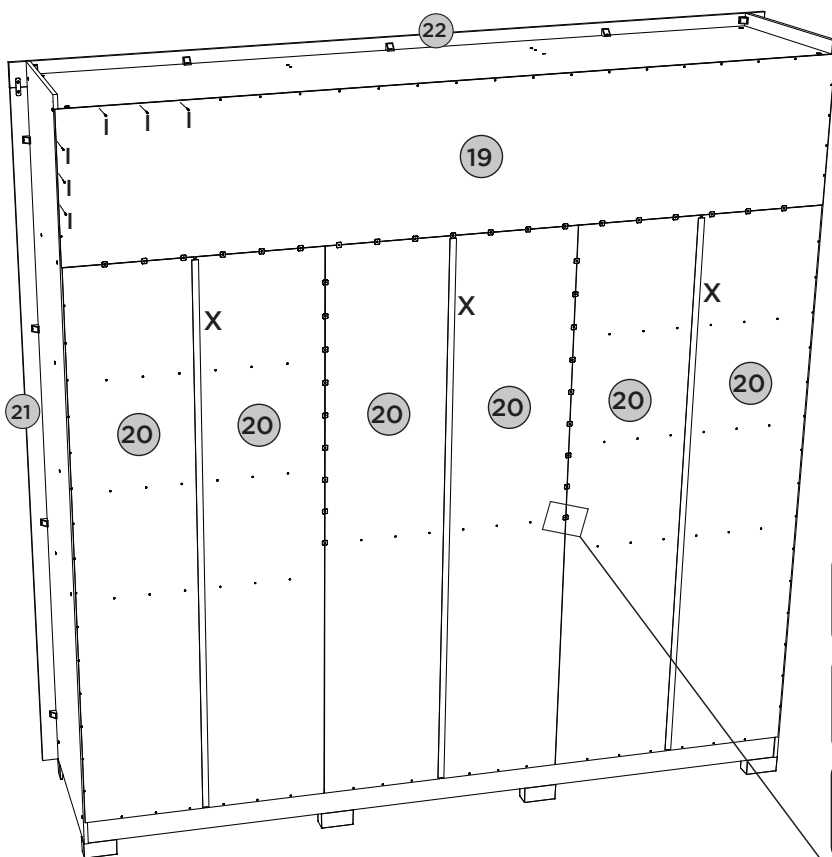
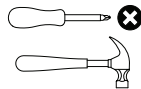
FERRAMENTAS NECESSÁRIAS





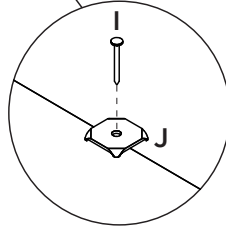
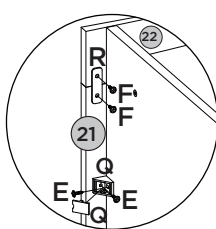
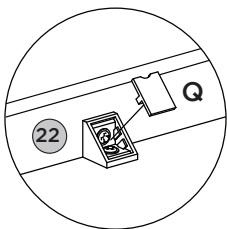
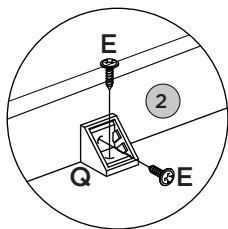

Fixar os pregos a uma distância de 100mm de um para outro.

Fijar las uñas a un distancia de 100mm uno a otro.

Fix the nails at a distance of 100mm from one to the other

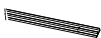

ACESSÓRIOS REQUERIDOS

F		20
U		02
V		04
W		01
Y		01
Z		01



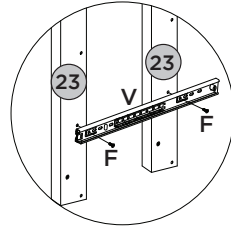
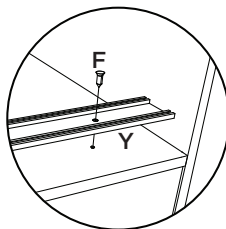
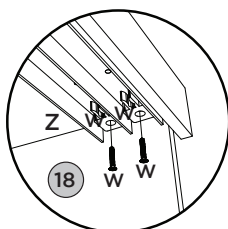
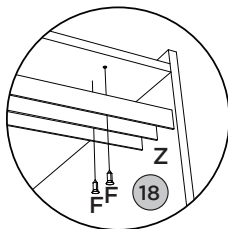
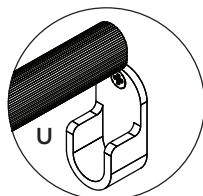
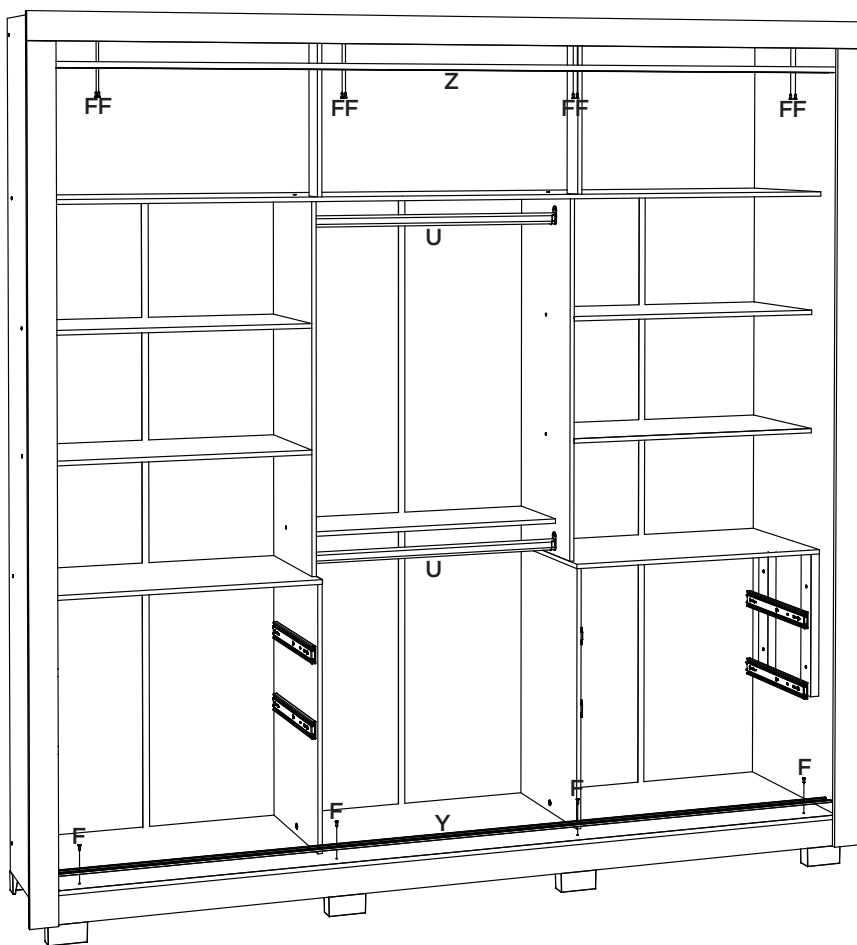
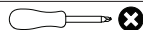

FERRAMENTAS NECESSÁRIAS



PEÇAS REQUERIDAS

24	PAINEL INFERIOR	x1
25	PAINEL MENOR	x1
26	PAINEL CENTRAL	x1
27=30	PAINEL INFERIOR SUPERIOR	x1

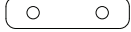
ACESSÓRIOS REQUERIDOS

F		18
G		12
R		09
W		01
AA		02

FERRAMENTAS NECESSÁRIAS

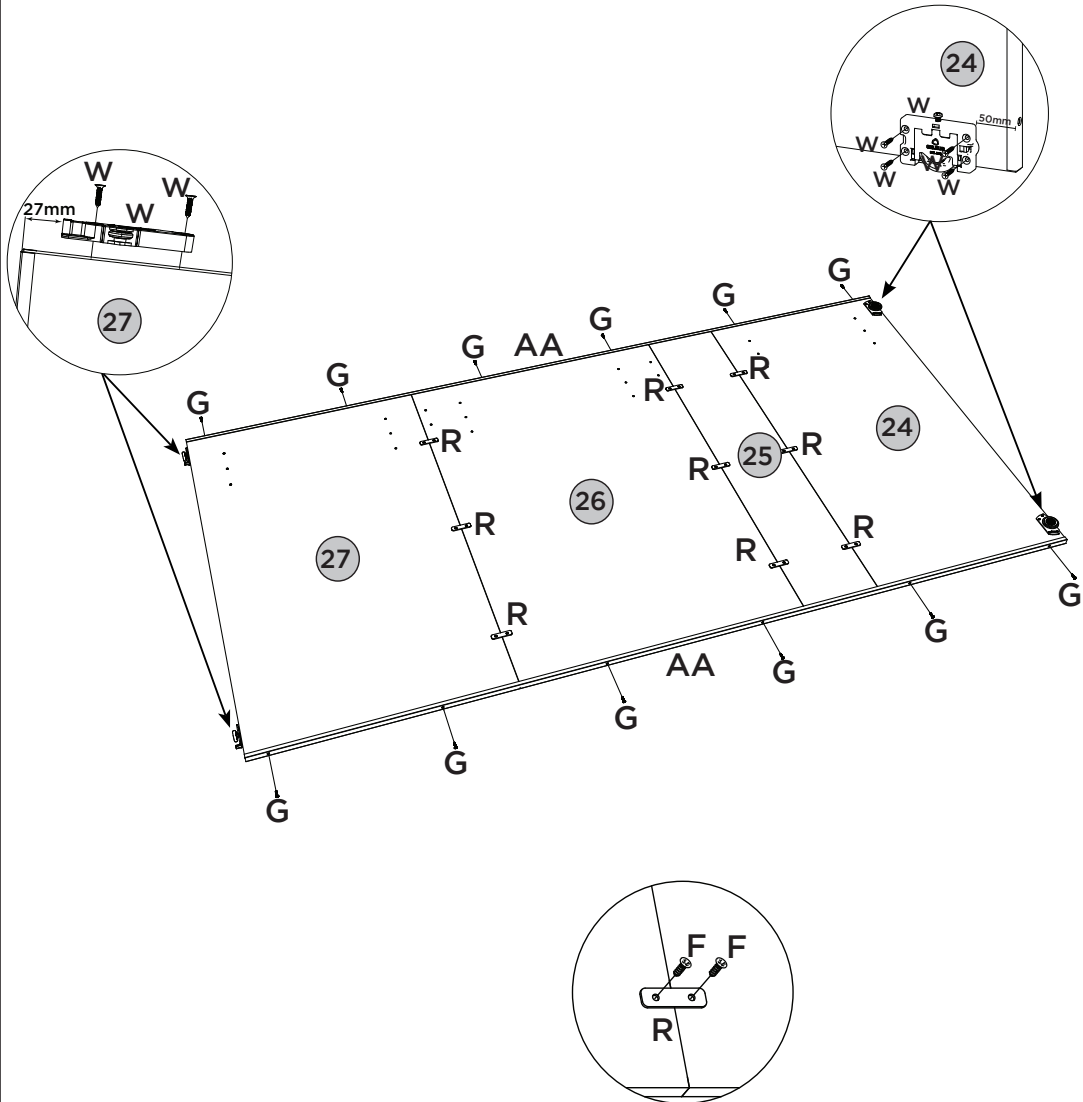

PEÇAS REQUERIDAS

28	MOLDURA	x3
----	---------	----

ACESSÓRIOS REQUERIDOS

D		24
---	---	----



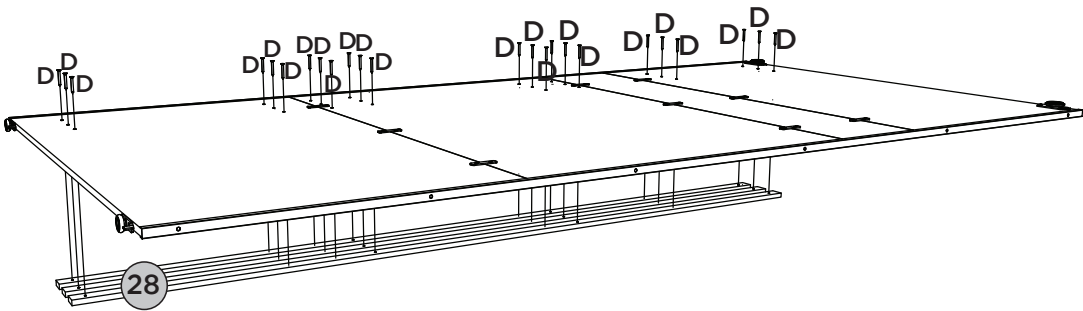

FERRAMENTAS NECESSÁRIAS



PEÇAS REQUERIDAS

29	PAINEL CENTRAL MAIOR	x1
30=27	PAINEL INFERIOR SUPERIOR	x2

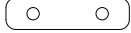
ACESSÓRIOS REQUERIDOS

F		12
G		12
R		06
W		01
AA		02

FERRAMENTAS NECESSÁRIAS

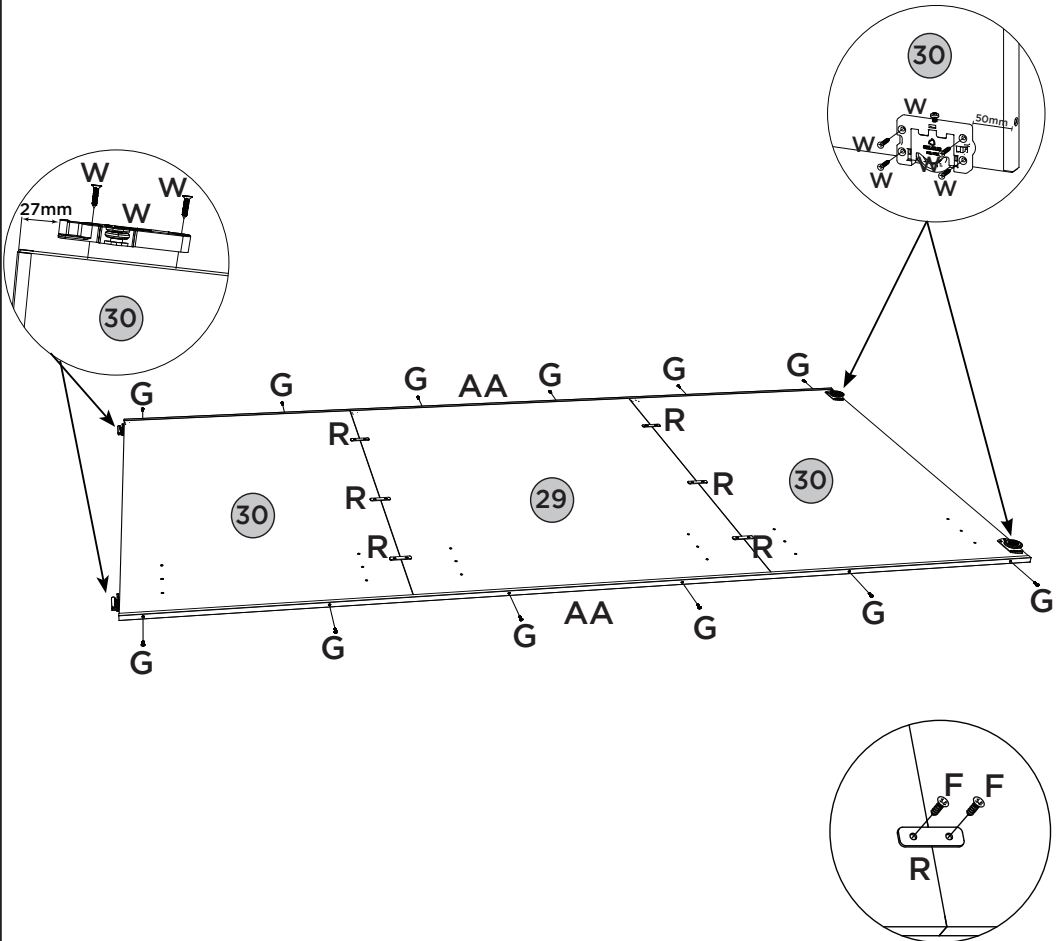
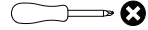

PEÇAS REQUERIDAS

28	MOLDURA	x3
----	---------	----

ACESSÓRIOS REQUERIDOS

D		18
---	---	----

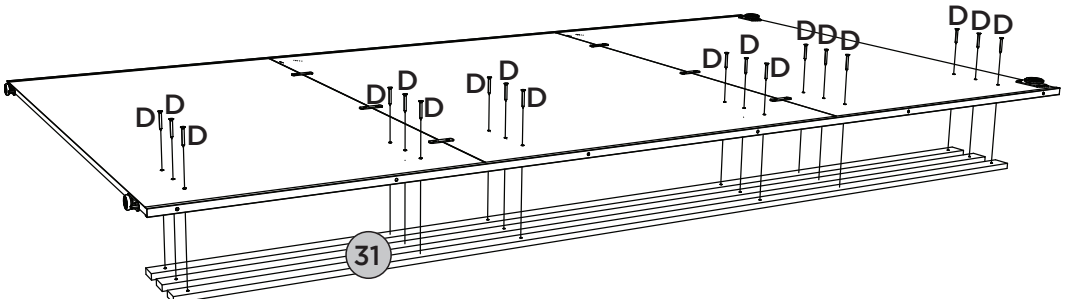

FERRAMENTAS NECESSÁRIAS



PEÇAS REQUERIDAS

24	PAINEL INFERIOR	x1
25	PAINEL MENOR	x1
26	PAINEL CENTRAL	x1
27=30	PAINEL INFERIOR SUPERIOR	x1
29	PAINEL CENTRAL MAIOR	x1
30=27	PAINEL INFERIOR SUPERIOR	x2

ACESSÓRIOS REQUERIDOS

AD		24
AG		16

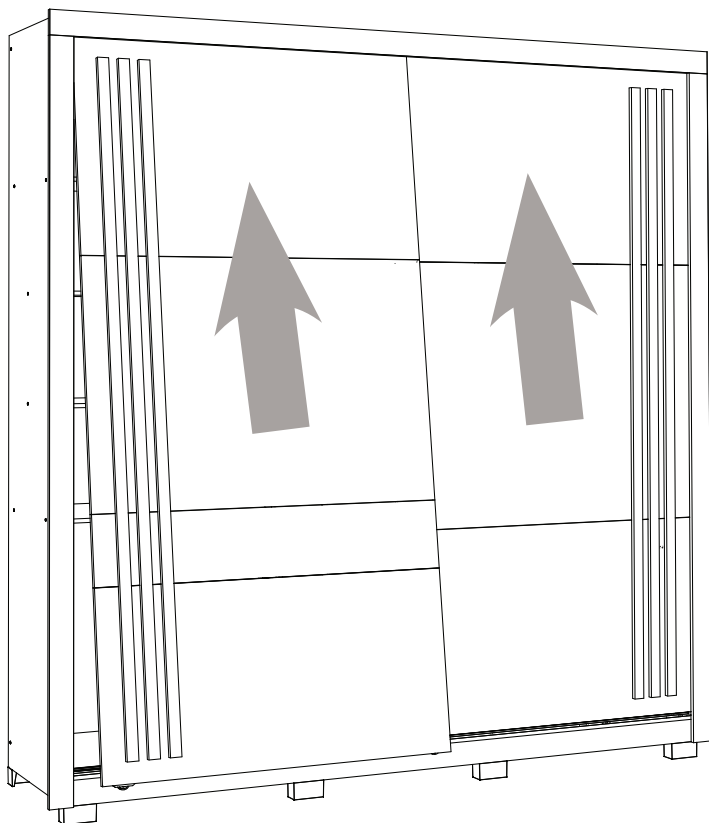

Para a colocação das portas nos trilhos encaixe primeira a porta no trilho de PVC superior (Z) e em seguida no trilho de alumínio inferior (Y).

Para la colocación de las puertas en la pista instalación de la puerta en la primera banda superior PVC (Z) y luego el riel de aluminio inferior (Y).

For placing the doors on the rails fitting the door on the PVC rail first (Z) and then on the lower aluminum rail (Y).



PASSO 19

ITM/D300-

PEÇAS REQUERIDAS

33	LADO DE GAVETA	x8
----	----------------	----

ACESSÓRIOS REQUERIDOS

K		32
AB		

FERRAMENTAS NECESSÁRIAS

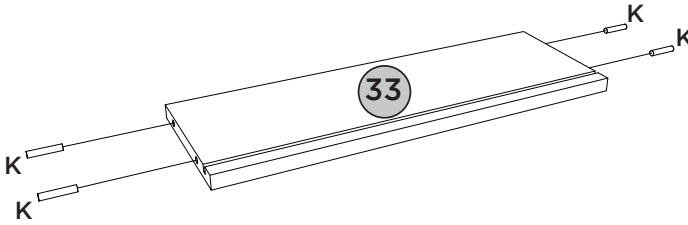

PASSO 20

PEÇAS REQUERIDAS

32	RIPA DE TRÁS	x4
33	LADO DE GAVETA	x8

ACESSÓRIOS REQUERIDOS

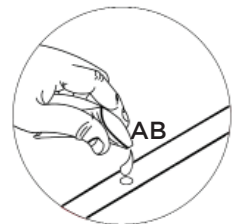
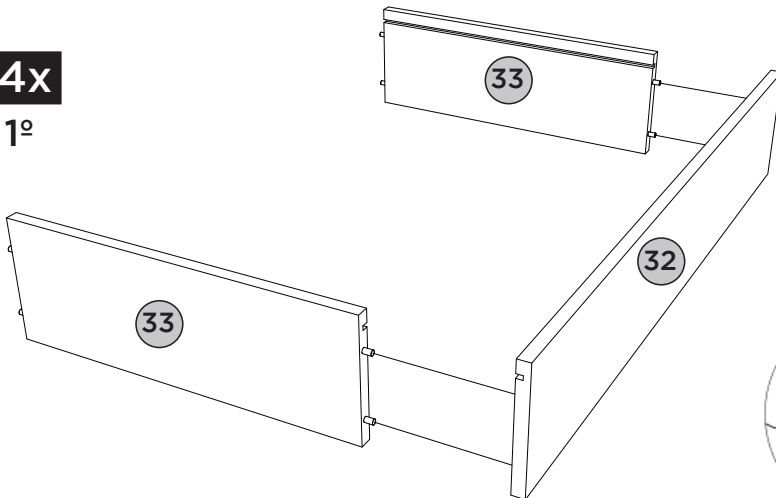

AB		
----	---	--

4x**1º**

PEÇAS REQUERIDAS







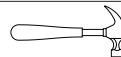
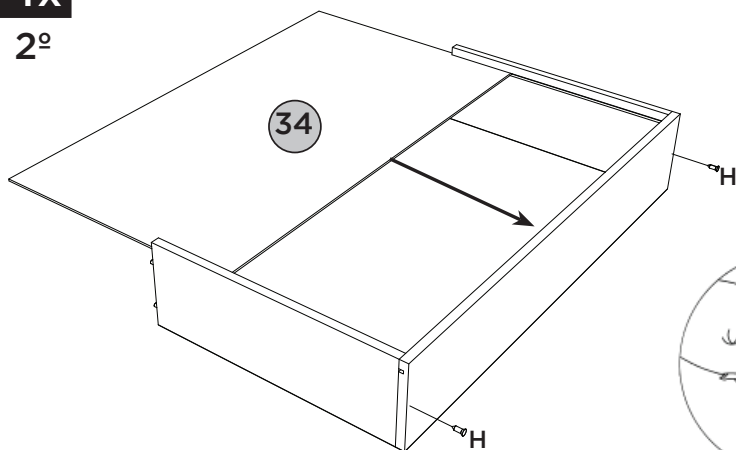
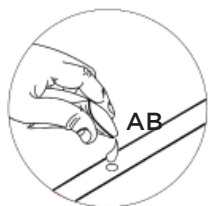
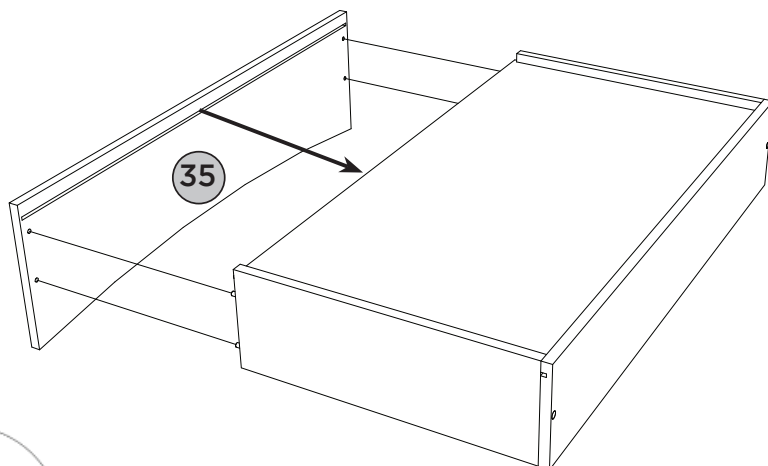

34	FUNDO DE GAVETA RECORTADO	x4
35	FRENTE DE GAVETA	x4

ACESSÓRIOS REQUERIDOS

H		08
AB		

FERRAMENTAS NECESSÁRIAS

4x
2º

4x
3º

ACESSÓRIOS REQUERIDOS

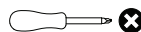
F			40
G			08
L			08
M			08
V			04

FERRAMENTAS NECESSÁRIAS



4x
4º

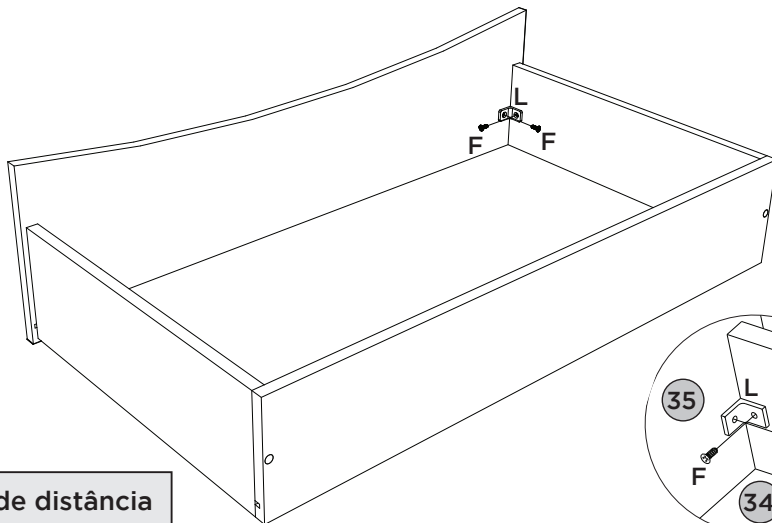

4x
5º



Deixar 3mm de distância da frente de gaveta.

Deje una separación de 3mm del frente del cajón.

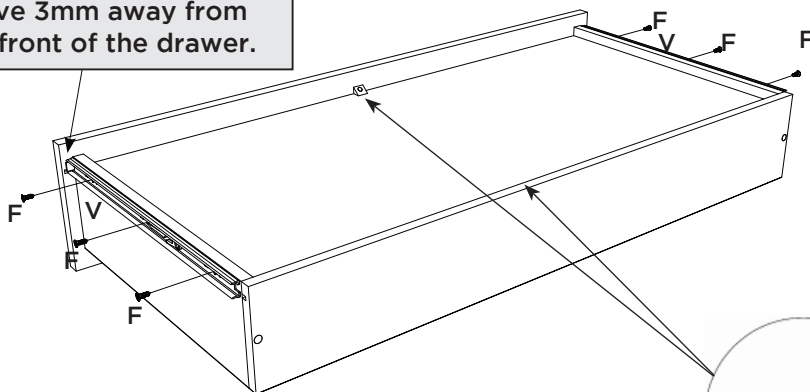
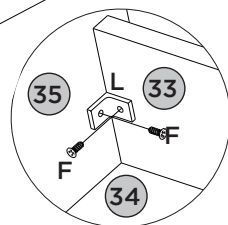
Leave 3mm away from the front of the drawer.



ACESSÓRIOS REQUERIDOS

AC		04
AE		30
AF		03
AH	HENN	01

Pesos máximos recomendados com carga distribuída
 Peso máximo recomendado con la carga distribuida
 Recommended maximum weight with distributed load.

2290mm

2300mm

515mm

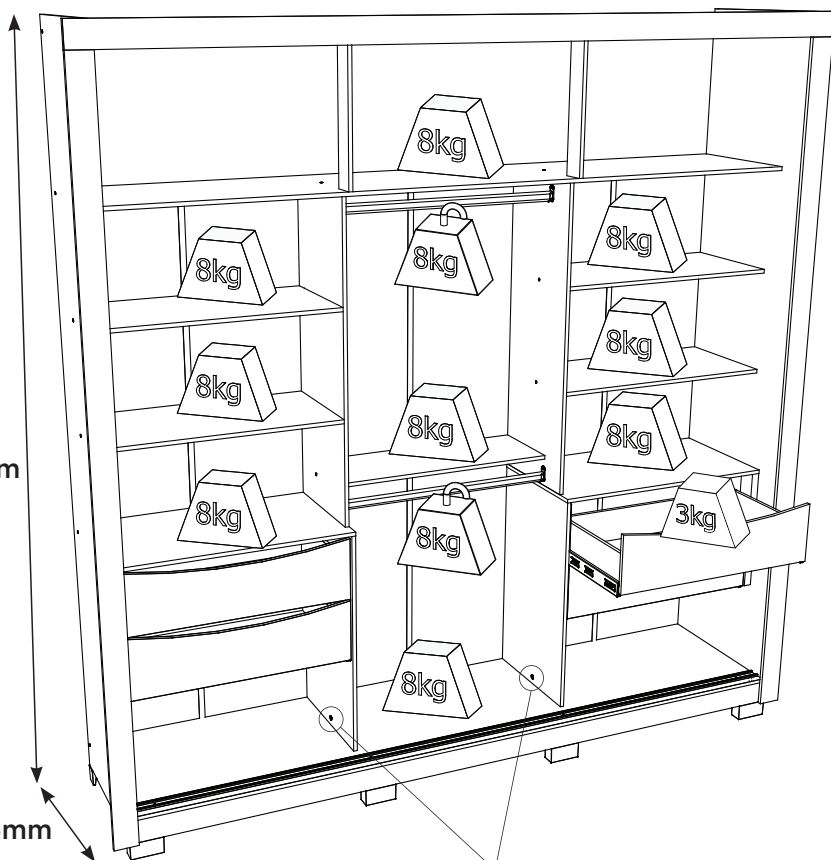

PERFECT CORRECTION
 CORRECCIÓN PERFECTA

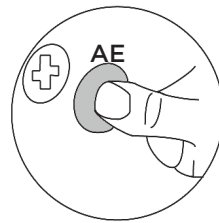
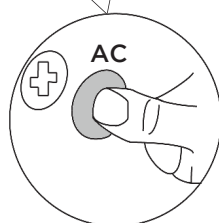
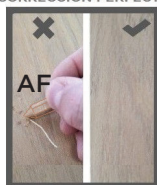

Produto Concluído
Producto terminado
Finished Product

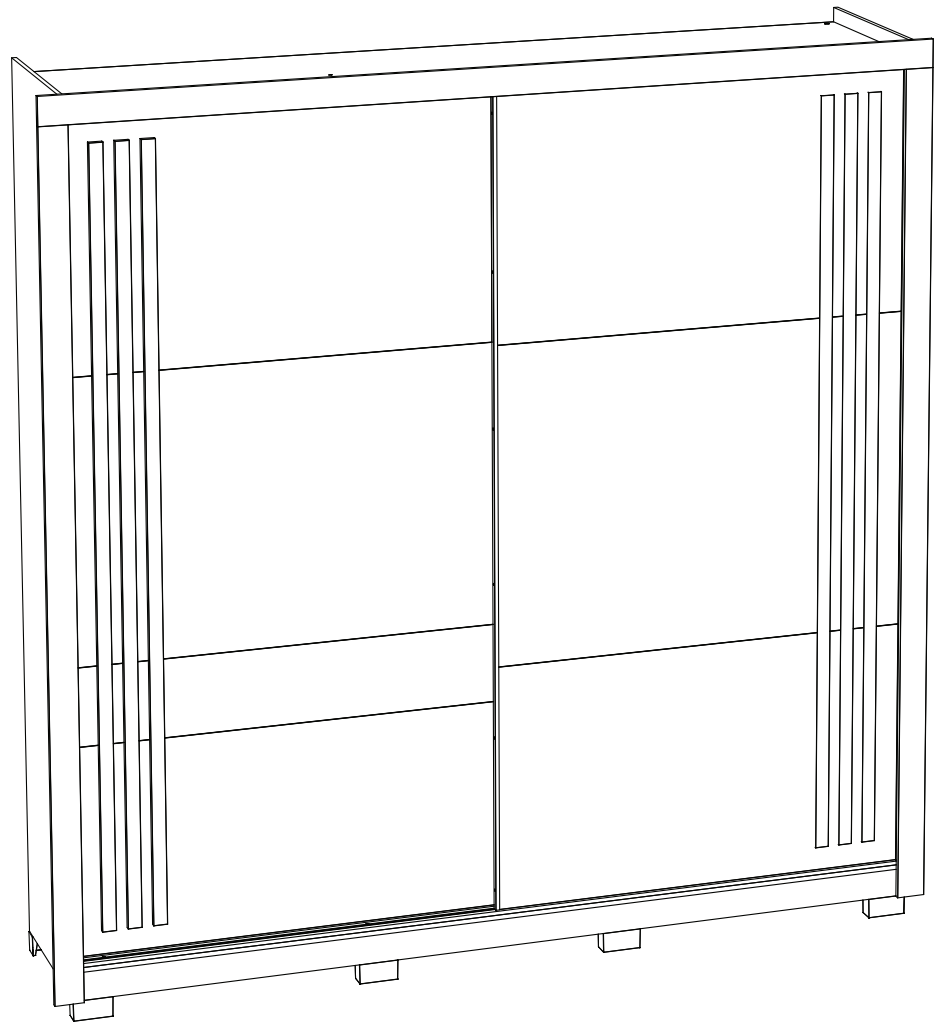

HENNInd. e Com. de Móveis Henn
Mondai - SC - Brasil

☎ +55 49 3674.3500

📷 @moveishenn
www.henn.com.br**INSTRUÇÕES DE
MONTAGEM****KIT ESPELHO 750x400x3 COM 4 UNIDADES**

c O968-64 - Prata

Item	Caixa	Qtd	Descrição	Medidas (mm)
01	1/1	04	Espelho	750x400x3

Exemplo:
Porta de Correr
(Roupeiro Aston 2Pts)

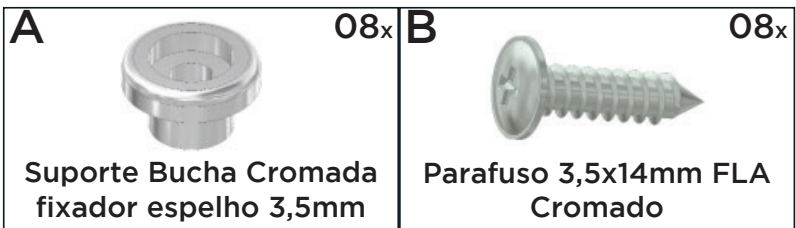
Ferragens**AVISO**

Para limpeza de seu móvel, use uma flanela seca ou umedecida, e não utilize produtos químicos que possam danificar seu produto.

SISTEMA DE MONTAGEM

O sistema de montagem dos produtos, funciona de acordo com a ordem crescente dos números indicados no desenho. Ex: 01, 02, 03, 04... até a conclusão da montagem.

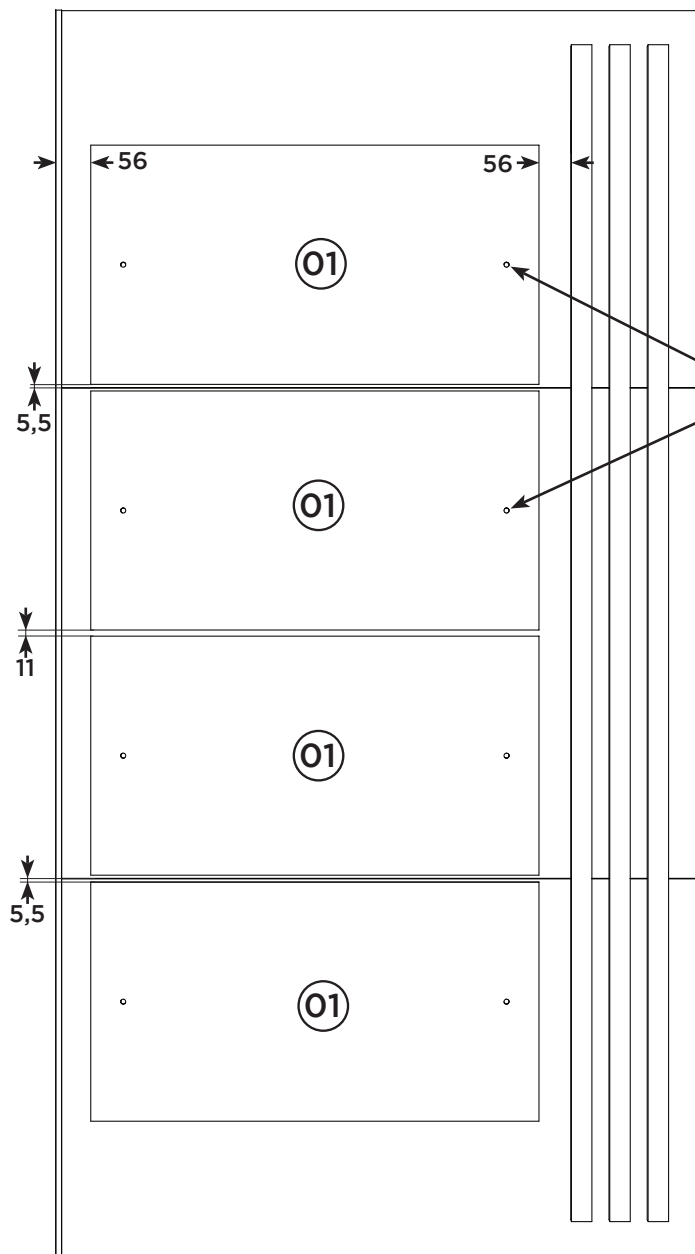
Medidas em mm

Fixar o Espelho com a Bucha (A) e o Parafuso (B)
Utilizar a parafusadeira com o torque 3.

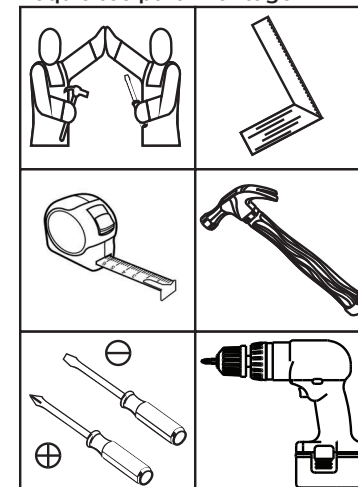
Requisitos para montagem

Imagens meramente ilustrativas