

Nº	CÓDIGO CODE ASSISTÊNCIA ATTENDANCE	NOME DA PEÇA/DESCRIPCIÓN PIEZAS/DESCRIPTION PARTS	MEDIDAS (mm) MEASURES (mm)	QTD.	MARROCOS OFF WHITE	BRANCO NEVE BRANCO NEVE
01	RG138.19.00	Lateral interna dir/Divisória interna/Inner side	1402x450x12	01	275792	278559
02	RG138.04.00	Base sob gaveta/Base/Shelf	1166x450x12	01	275800	278570
03	RG138.02.00	Base interna/Base interna/Shelf	577x338x12	02	275721	275721
04	RG138.06.00	Ripa batente frontal /Listones/Battens	900x80x12	01	275801	278571
05	RG138.06.01	Ripa batente /Listones/Battens	387x80x12	03	275802	278572
06	RG138.34.00	Forro gaveta/Revés cajón/Botton	502x355x2,5	04	275481	275481
07	RG138.03.00	Base maleiro/Base interna/Shelf	2344x450x12	01	275779	278546
08	RG138.25.00	Porta/Puerta/Door	1810x292x15	08	280353	280356
09	RG138.13.00	Forro/Revés/botton	1414x589x2,5	04	275480	275480
10	RG138.17.00	Lateral externa direita/Lateral derecha/Inner side	2000x450x12	01	275790	278557
11	RG138.18.00	Lateral externa esquerda/Lateral izquierda/Inner side	2000x450x12	01	275791	278558
12	RG138.05.00	Base superior/Base superior/Shelf	2344x450x12	01	275776	278543
13	RG138.29.00	Ripa traseiro de gaveta/Listón del cajón trasero/Rear drawer slat	478x80x12	04	275726	275726
14	RG138.30.00	Rodapé frontal/Zócalo delantero/Front panel	2344x100x12	01	275777	278544
15	RG138.32.00	Rodapé traseiro/Zócalo de atrás/Border back	2344x100x12	01	275676	275676
16	RG138.14.00	Frente gaveta/Frente cajón/Drawer front	530x145x15	04	280355	280355
17	RG138.15.00	Lateral de gaveta/ Lado del cajón/ Drawer side	350x100x12	08	275708	275708
18	RG138.07.00	Chapéu/Detalle superior/Hat	2368x80x15	01	275778	278545
19	RG138.01.00	Base inferior/Base/Shelf	2344x450x12	01	275775	278542
20	RG138.13.01	Forro/Revés/botton	1178x399x2,5	02	275720	275720
21	RG138.19.01	Lateral interna dir/Divisória interna/Inner side	1402x450x12	01	275793	278560
22	RG138.31.00	Rodapé interno/Zocalo interno/Internal baseboard	404x100x12	01	275727	275727
23	RG138.19.02	Lateral interna cti/Divisória interna/Inner side	490x450x12	01	275803	278573
24	RG138.27.00	Prateleira/Base /Shelf	577x338x12	02	275722	275722

Ferragens/Herrajes/Hardware

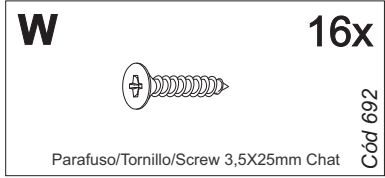

Obs: a régua serve para medição da ferragem.
Nota: la regla se utiliza para medir el hardware.
Note: the ruler is used to measure the hardware.

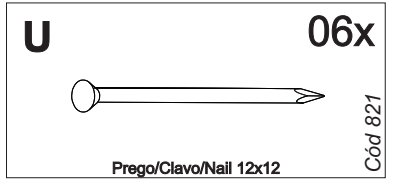
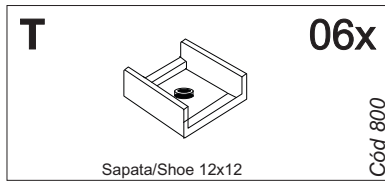
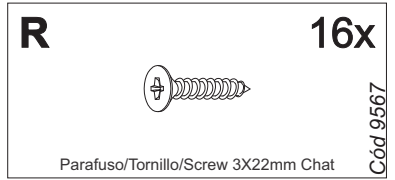
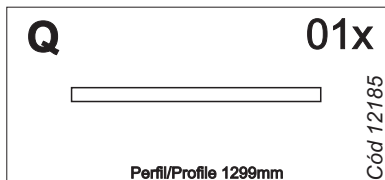
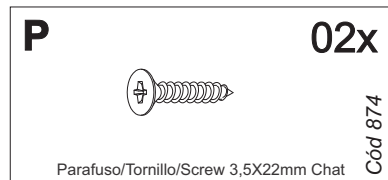
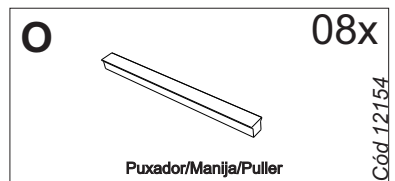
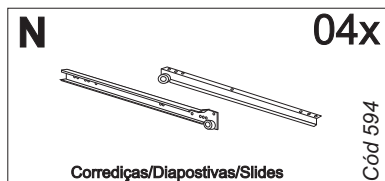
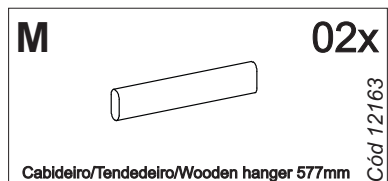
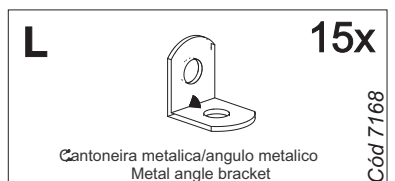
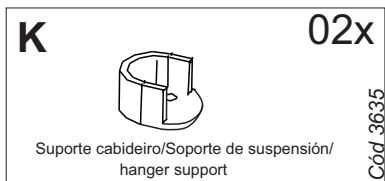
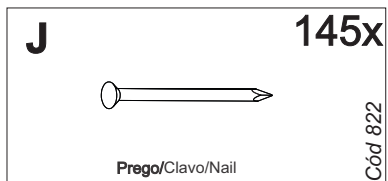
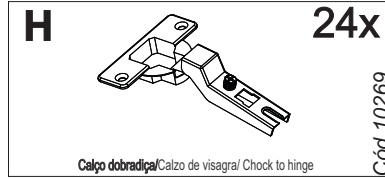
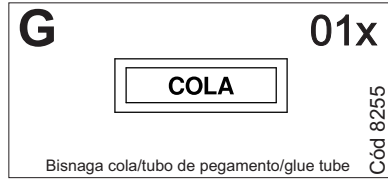
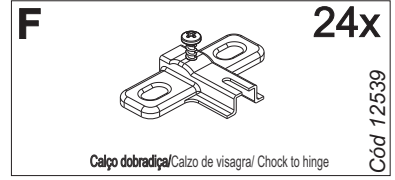
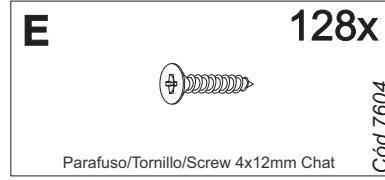
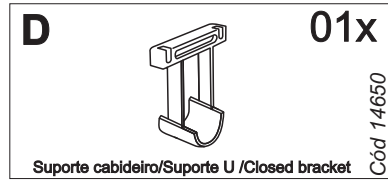
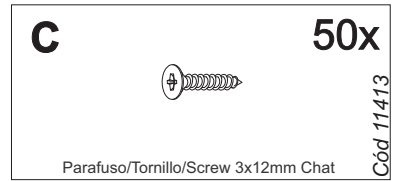
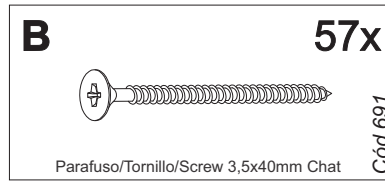
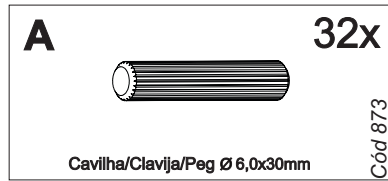

Medidas em mm
Measures in mm
Mesuras en mm

Pré-Montagem/Preparación Piezas/ Pre-assembly



Utilizar cola nas cavilhas
 Usa pegamento en los tacos.
 Use glue on the dowels

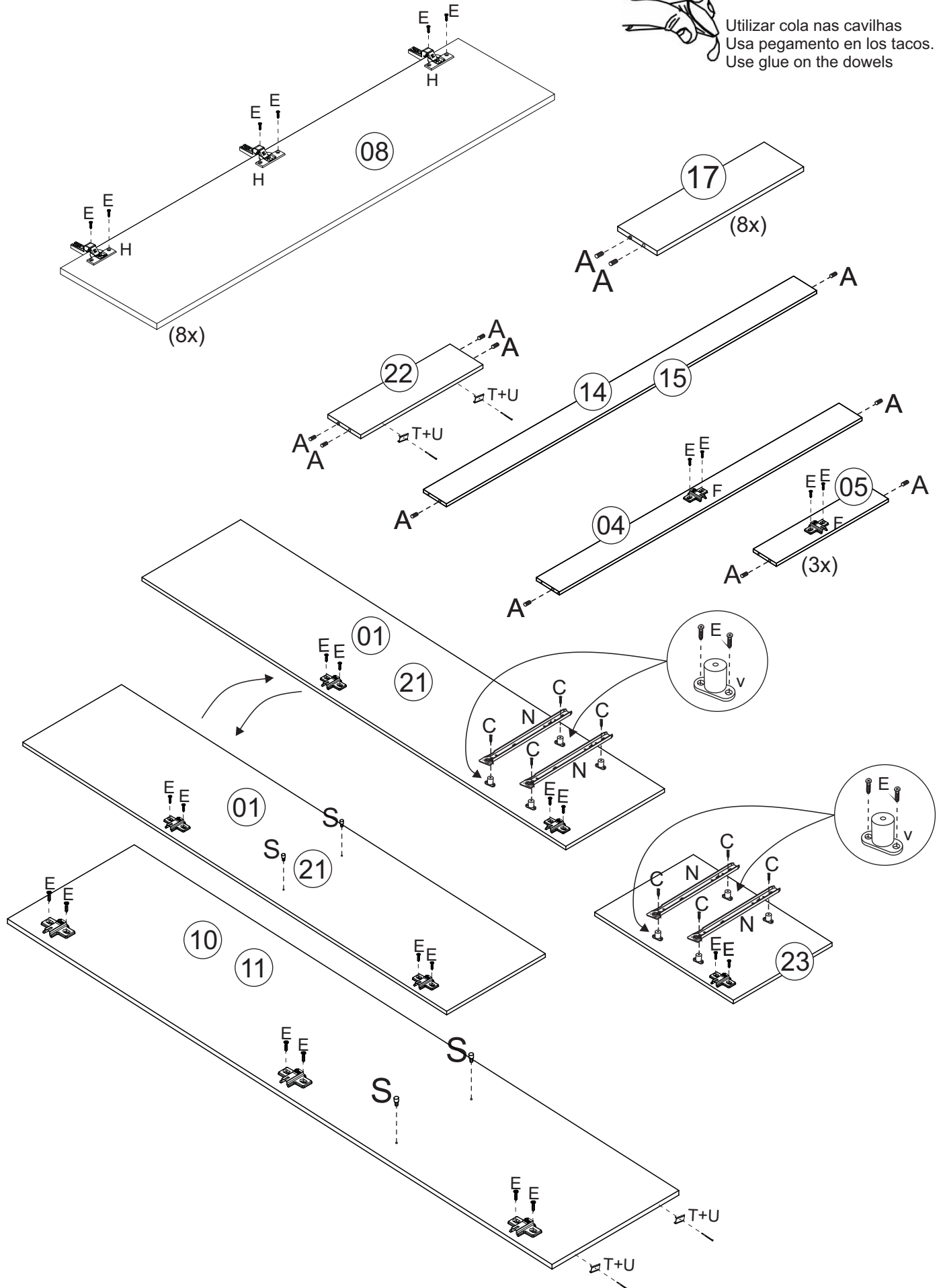

01 → Montagem/Montaje/Assembly

Obs: Roupeiro montado deitado.
Nota: Armario empotrado tumbado.
Note: Fitted wardrobe lying down.

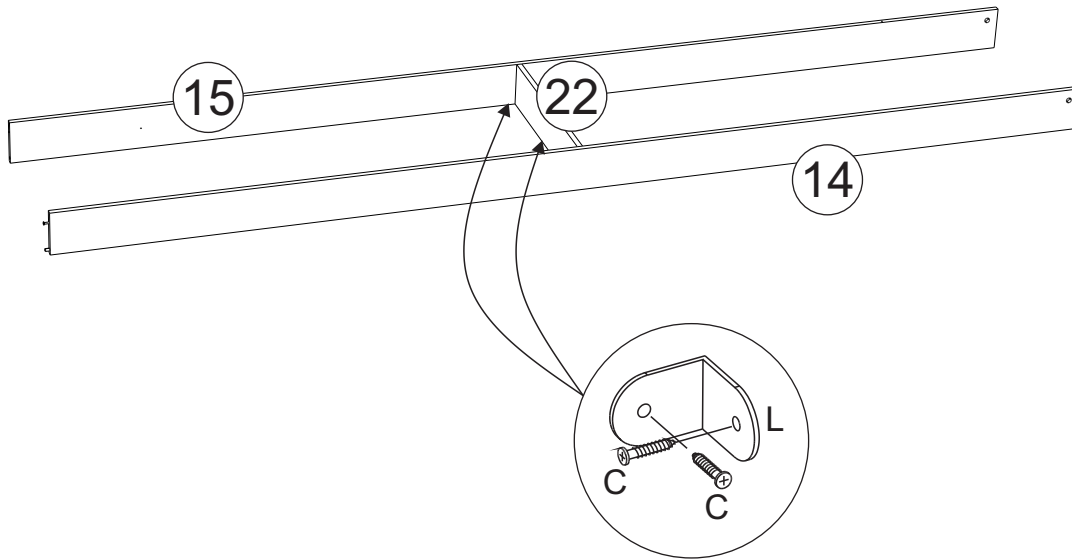

02 → Montagem/Montaje/Assembly

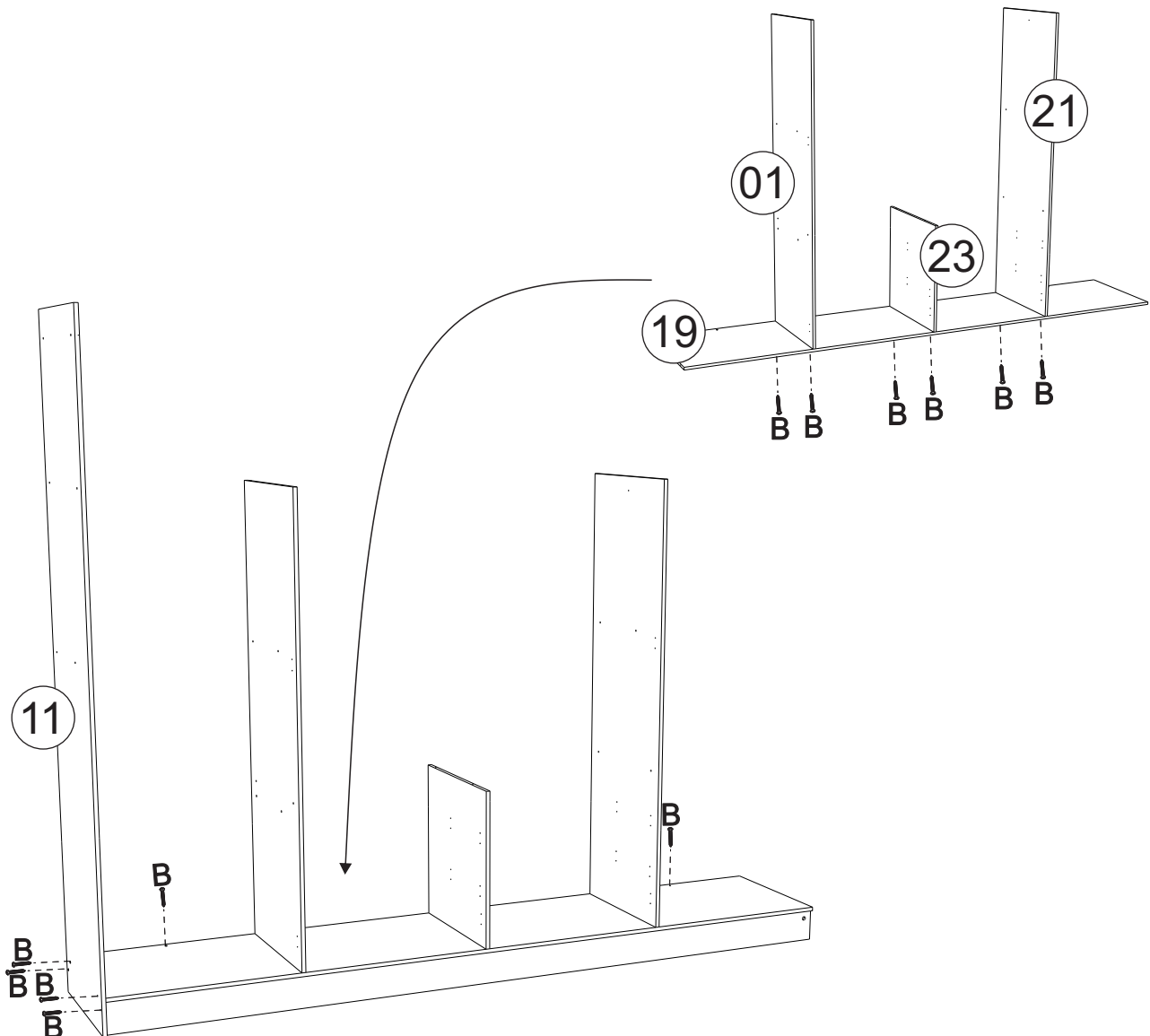

03 Montagem/Montaje/Assembly

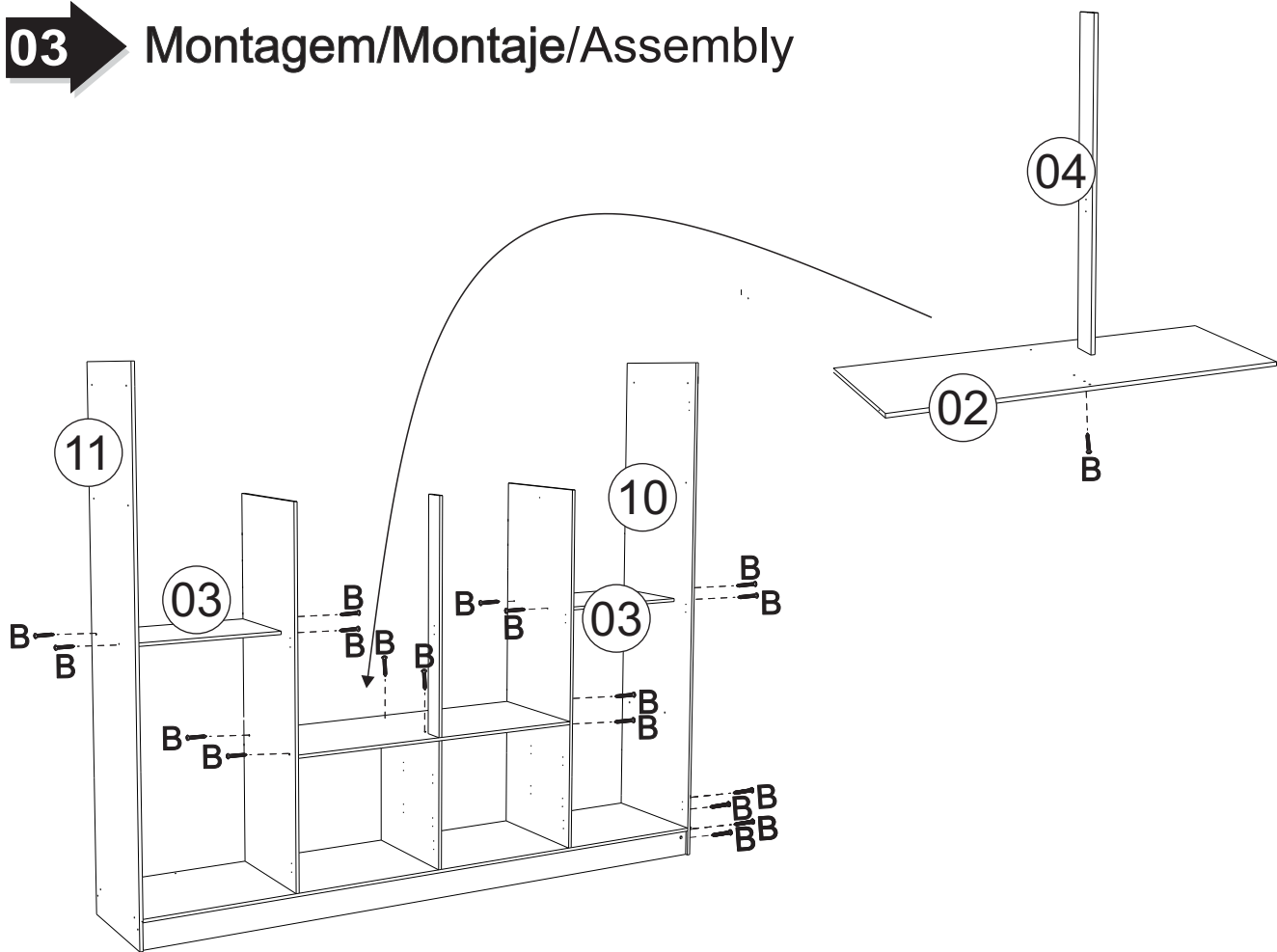

04 Montagem/Montaje/Assembly

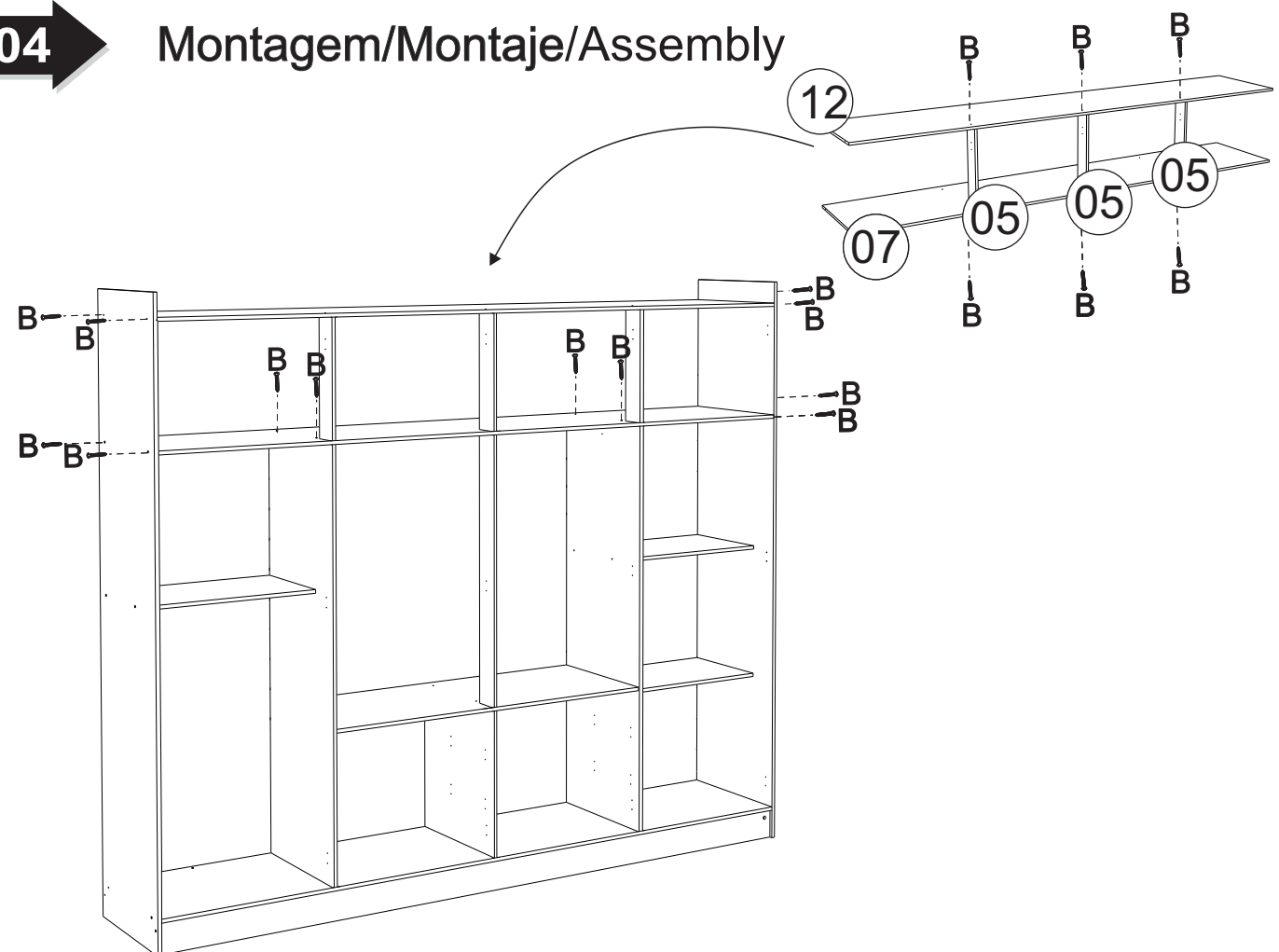

05 Montagem/Montaje/Assembly

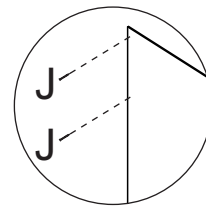
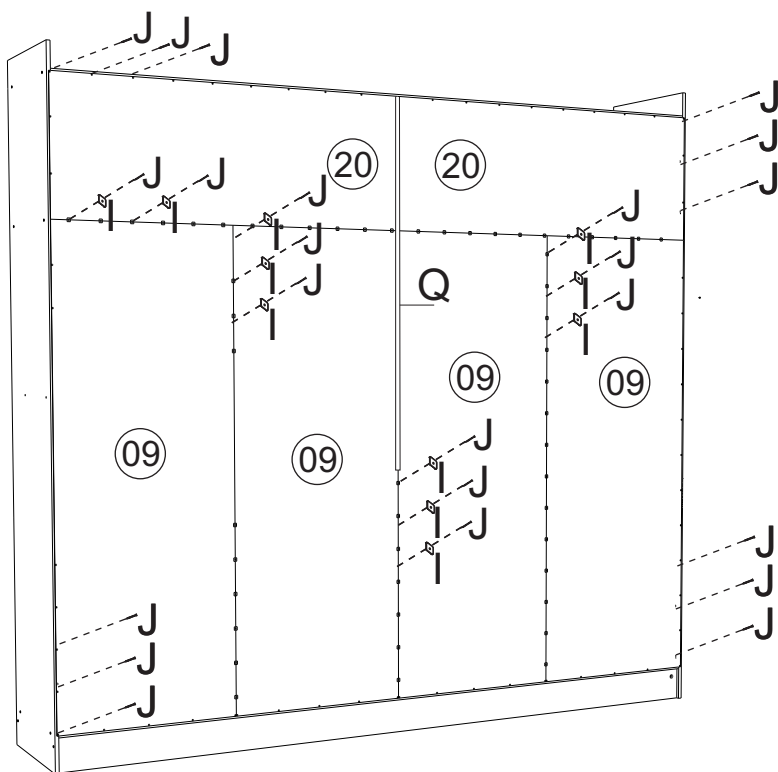

*Colocar um prego (J) a cada 100mm
 *Colocar un clavo cada (J) 100mm
 *Place a nail every (J) 100mm

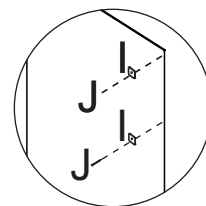

*Usar o prego (J) e a junção (I) a cada 150mm
 *Usar el clavo (J) y la junta (I) cada 150mm
 *Use the nail (J) and the joint (I) every 150mm

06 Montagem/Montaje/Assembly

(4x)

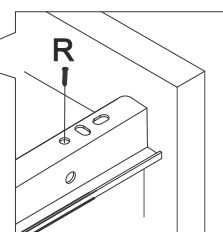
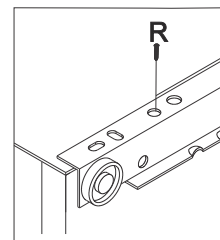
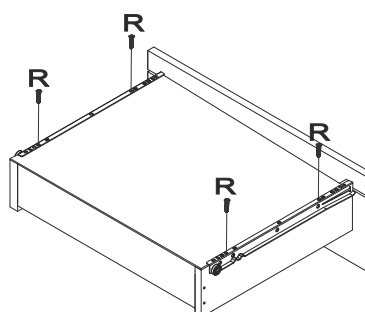
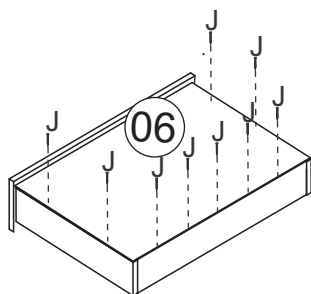
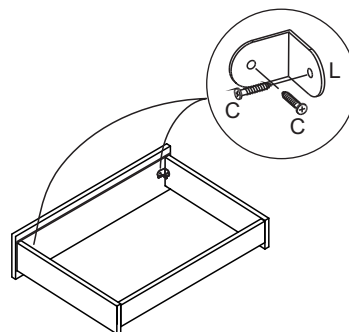
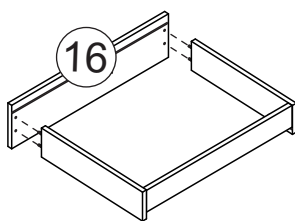
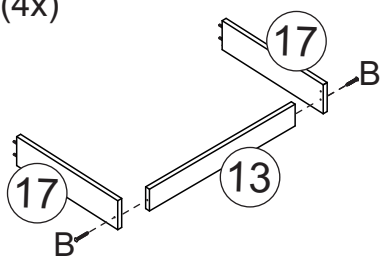



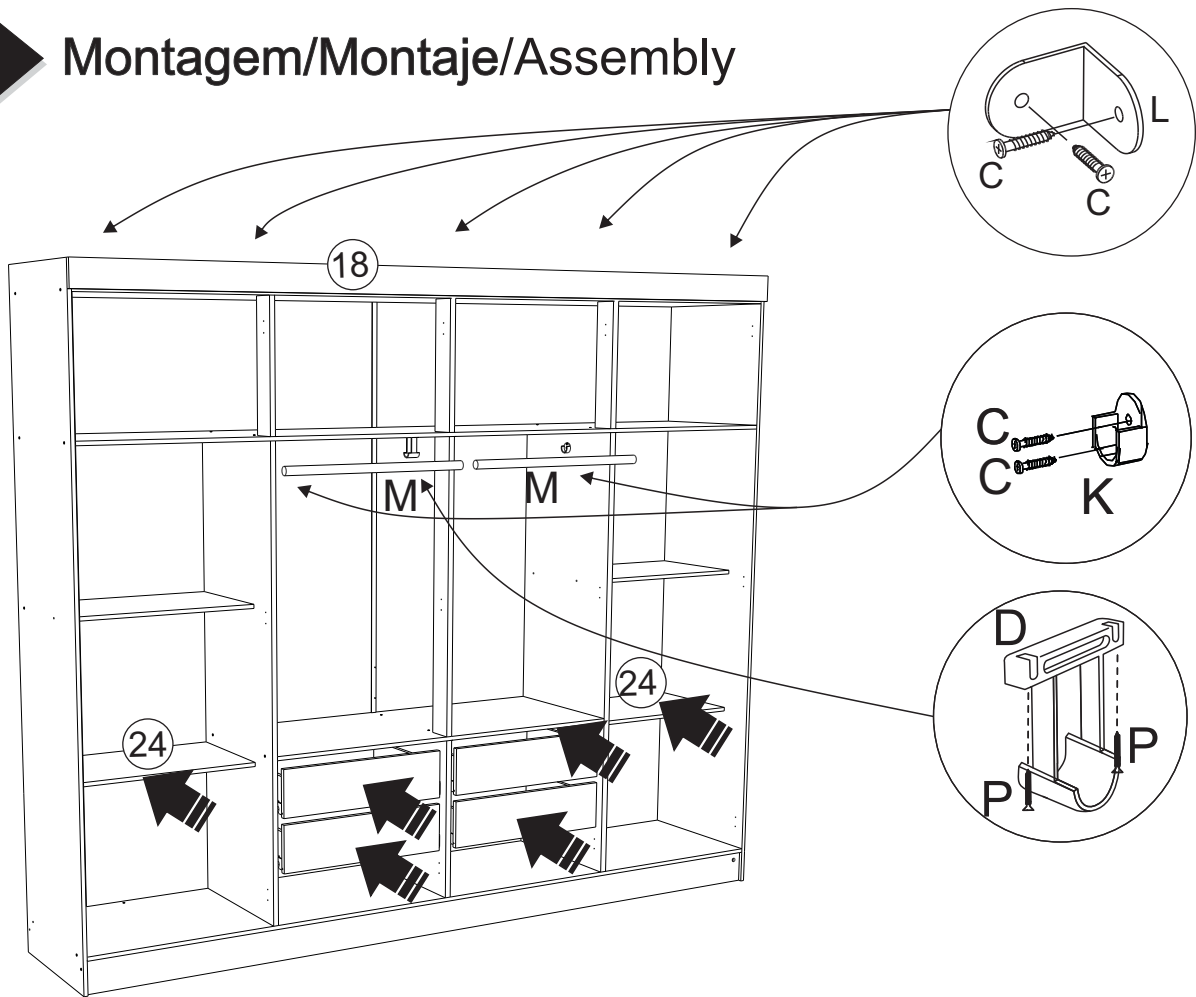

07 → Montagem/Montaje/Assembly

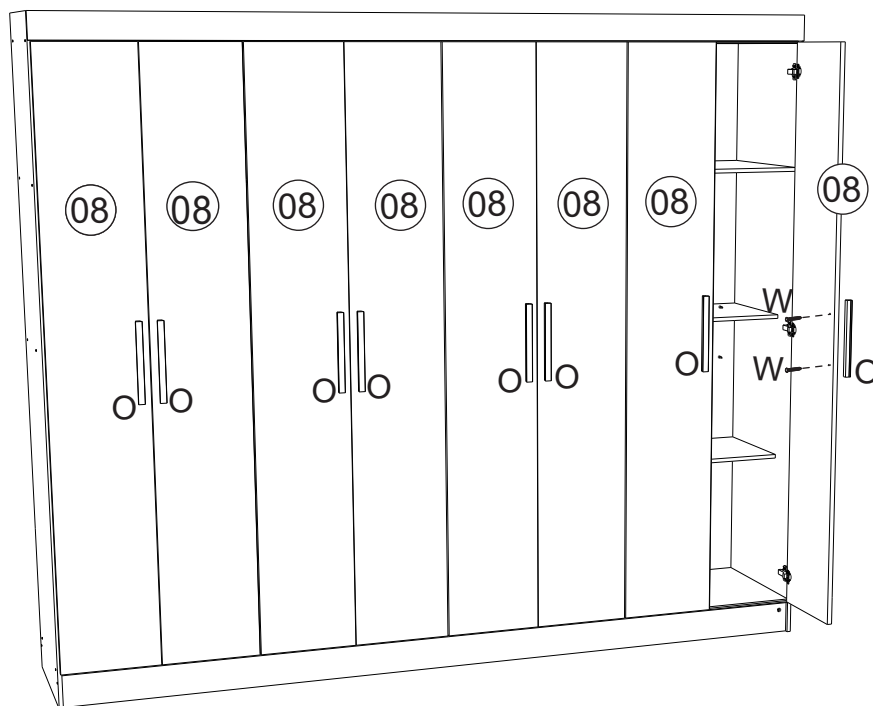

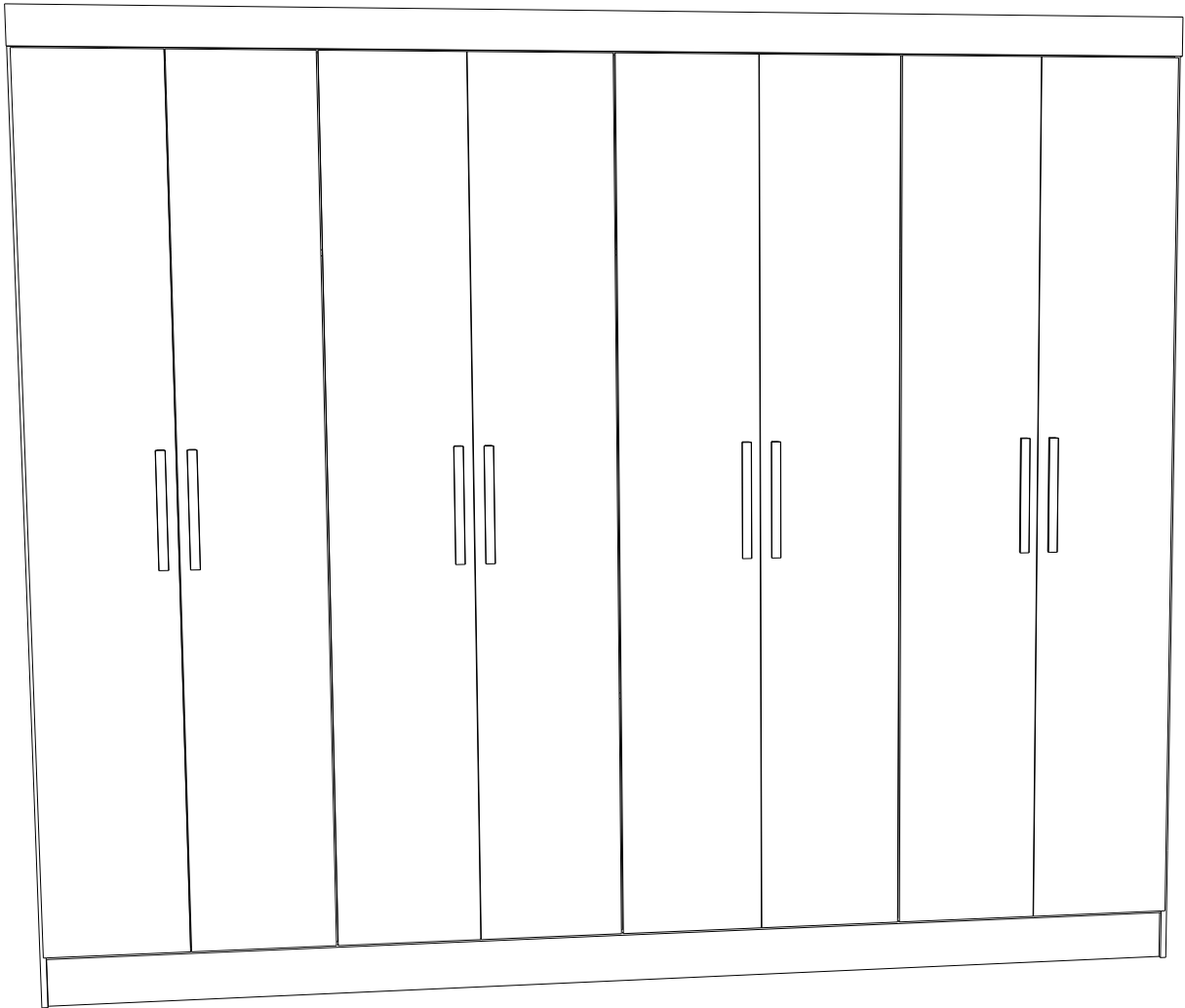
08 → Montagem/Montaje/Assembly





 Giz para madeira	Produto para ser aplicado em caso de riscos na superfície.
 Giz para madeira	Product to be applied in case of scratches on the surface.
 Giz para madeira	Producto para ser aplicado en caso de rayas en la superficie.

